

N Straight Cable Plug

N1C50-G142A/144

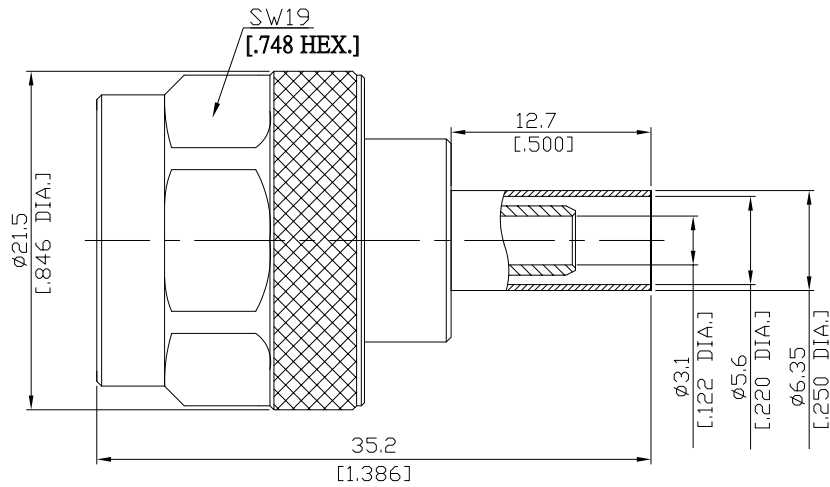

All dimensions are in mm [inch]

Tolerances according to DIN ISO 2768-mH

Interface

According to IEC 61169-16; MIL-STD-348A/304

Electrical Data

Impedance 50 Ω
 Frequency DC to 6 GHz
 VSWR (Return Loss) ≤ 1.15 (≥ 23.1 dB)
 Insertion Loss ≤ 0.05
 Working voltage (at sea level) 1400 V rms

- Limitations are possible due to the used cable type and manufacturing process -

Mechanical Data

Coupling mechanisms Screw-lock
 Centre contact Soldered or Crimped
 Cable entry Crimped

Environmental Data

Temperature range -65°C to +165°C
 RoHS compliant

Material And Plating

Connector parts	Material	Plating
Centre contact	Brass	Gold plating(Nickel underplated)
Body	Brass	Copper-Tin-Zinc Alloy
Insulator	PTFE	
Gasket	Silicone Rubber	
Coupling nut	Brass	Copper-Tin-Zinc Alloy
Crimp ferrules	Brass	Copper-Tin-Zinc Alloy

Suitable Cables

RG-55, RG-142, RG-223, RG-400

Packing

Single, 5-pack, or 100

N Straight Cable Plug

N1C50-G142A/144

Recommended Cable Stripping Dimensions

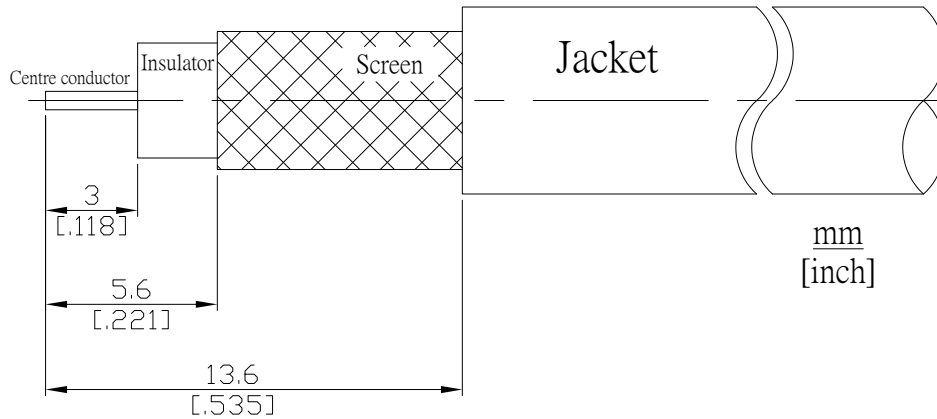

Crimp Dimensions [HEX]

Crimp ferrule	5.41 mm [.213 inch]
Centre contact	1.73 mm [.068 inch]