

N Straight Panel Receptacle Jack (Solder End)

N2GFB50-2827A/H4

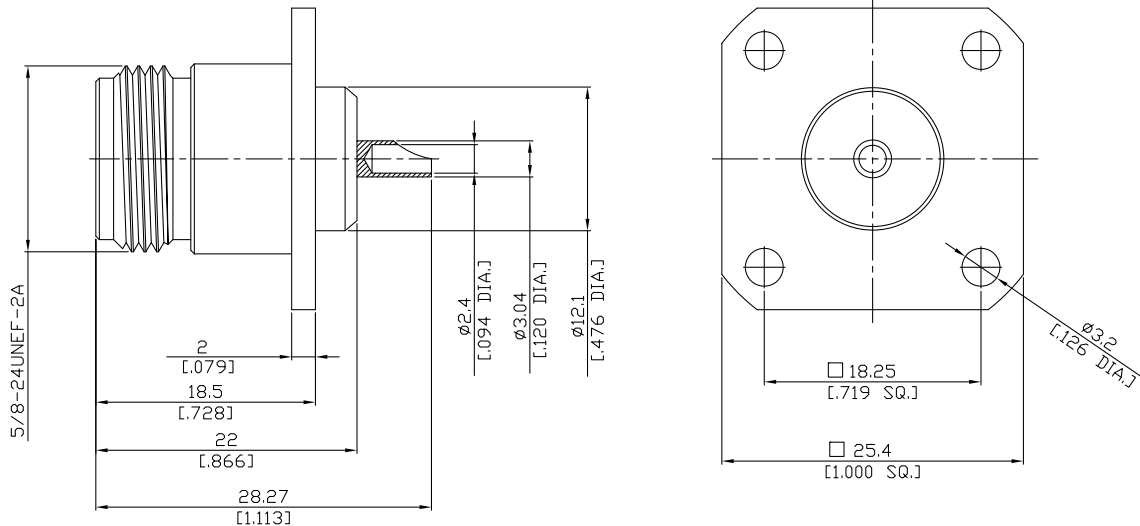

All dimensions are in mm [inch]
Tolerances according to DIN ISO 2768-mH

Interface
According to MIL-C-39012;MIL-STD-348A/304

Electrical Data
Impedance 50 Ω
Frequency DC to 11 GHz

Mechanical Data
Coupling mechanisms Screw-lock
Weight 0.0295 kg

Environmental Data
Temperature range -65°C to +165°C
RoHS compliant

Material And Plating

Piece Parts	Material	Plating
Centre contact	Phosphor Bronze	Gold plating(Nickel underplated)
Body	Brass	Copper-Tin-Zinc Alloy
Insulator	PTFE	

Packing
Single or 100

Related Document
Mounting Dimension MD16