

Fixed Attenuator plug/jack
SMA plug (male) / SMA jack (female)

FA-A1A25A-6G2W8/911-91

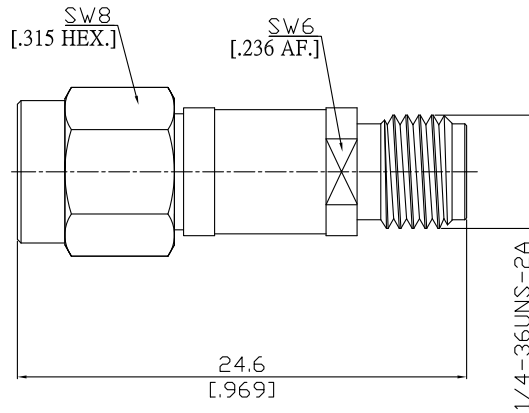

All dimensions are in mm [inch]
Tolerances according to DIN ISO 2768-mH

Interface

According to MIL-C-39012;MIL-STD-348A/310

Electrical Data

Impedance	50 Ω		
Interface frequency max.	DC to 6 GHz		
Frequency range	DC to 2 GHz	2 to 5 GHz	5 to 6 GHz
VSWR	≤ 1.1	≤ 1.25	≤ 1.3
Attenuation Tolerance (dB)	± 0.2 dB	± 0.3 dB	± 0.5 dB
Attenuation (dB)	8 dB		
Power rating (Watt)	2 W		

Mechanical Data

Coupling mechanisms	Screw-lock
Weight	0.0053 kg

Environmental Data

Temperature range	-55°C to +85°C
RoHS	compliant

Material And Plating

Connector parts	Material	Plating
Centre contact	Beryllium Copper	Gold plating(Nickel underplated)
Body	Brass	Gold plating(Nickel underplated)
Insulator	PTFE	
Gasket	Silicone Rubber	
Coupling nut	Brass	Gold plating(Nickel underplated)
Resistor	Thick film	

Connector parts	Material	Plating
Centre contact	Beryllium Copper	Gold plating(Nickel underplated)
Body	Brass	Gold plating(Nickel underplated)
Insulator	PTFE	

Packing

Single or 100