

2008.1 Product Guide [Microcomputer]

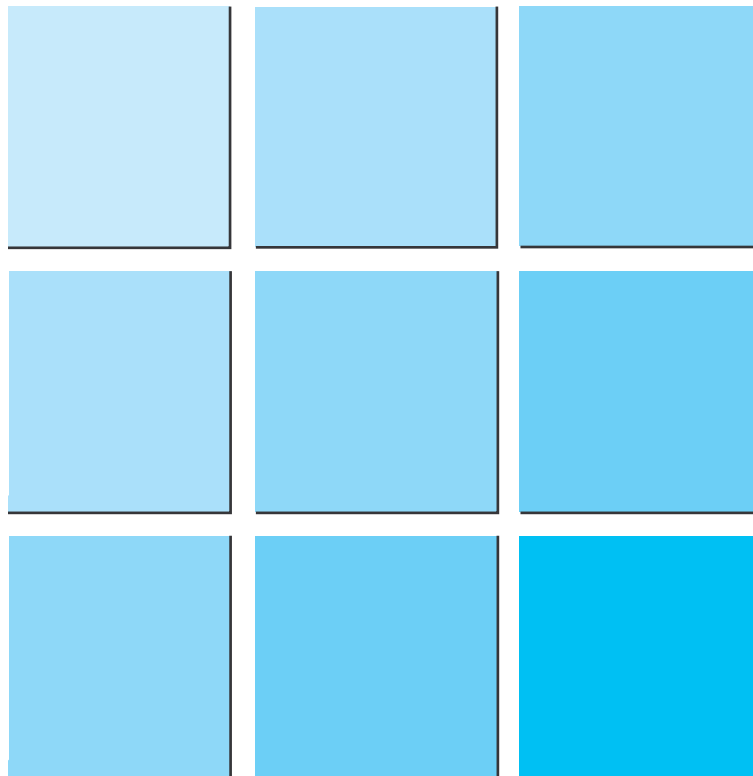

Technical Documentation of Electronic Devices

DATA BOOK
(DVD)



PRODUCT GUIDE
(GENERAL)



[ASSP-Memory-ASIC]



[Microcomputer]

ASSP

Memory

ASIC

Microcontroller

Package

DATA SHEET

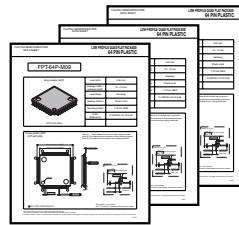
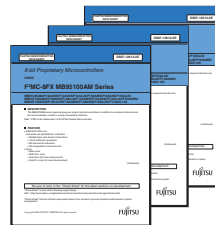
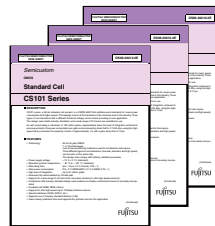
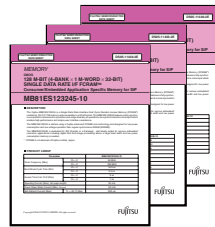
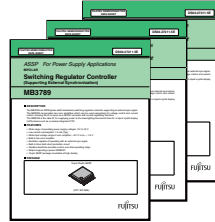

MANUAL

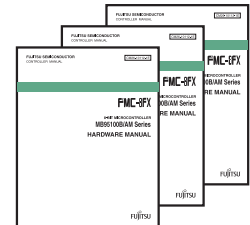

Product Line-up

		Page no.			
Microcomputers	Microcontrollers	8-bit	Proprietary	F ² MC-8L Family	4
				F ² MC-8FX Family	34
				Support tools	48
		16-bit	Proprietary	F ² MC-16LX Family	80
				F ² MC-16FX Family	136
				Support tools	146
	32-bit		FR Family	216	
			Support tools	258	
			Microcontroller product list	320	
			Support Hardware	346	

F²MC-8L Family

F²MC-16LX Family

FR Family

TRADEMARKS:

- Microsoft, Windows and Windows Media are either registered trademarks of Microsoft Corporation in the United States and/or other countries.
- The company names and brand names herein are the trademarks or registered trademarks of their respective owners.

THE I²C LICENSE:

Purchase of Fujitsu Microelectronics I²C components conveys a license under the Philips I²C Patent Rights to use, these components in an I²C system provided that the system conforms to the I²C Standard Specification as defined by Philips.

Microcomputer Range

Microcomputer Migration Path

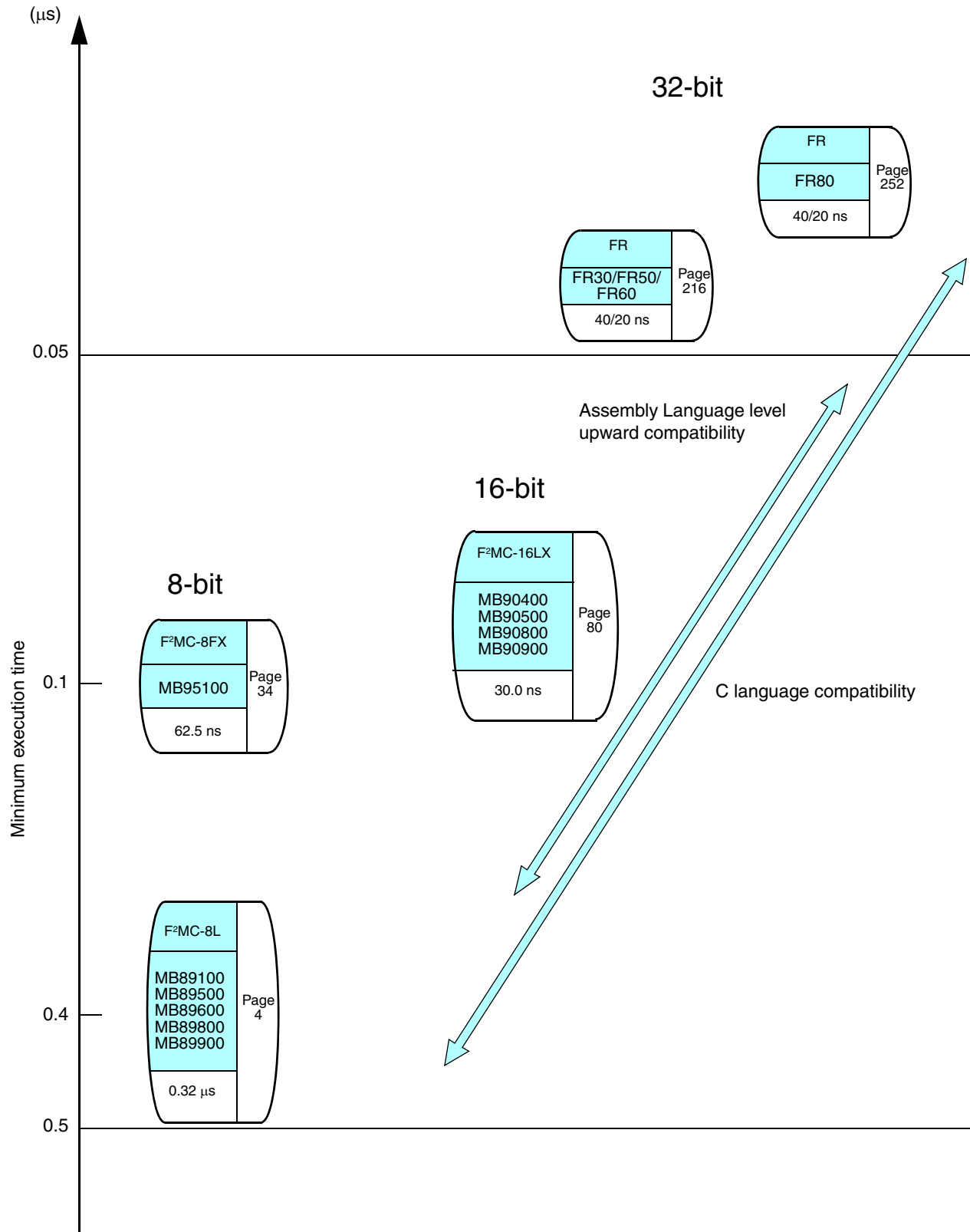

32-bit Microcontrollers

- FR (FR30 Series, FR50 Series, FR60 Series, FR80 Series)
A proprietary Fujitsu Microelectronics product developed for embedded applications
A microcontroller with a 32-bit RISC architecture
-

16-bit Microcontrollers

- F²MC-16LX (MB90400 series, MB90500 series, MB90800 series, MB90900 series)
Features: Supports high-performance, low-power consumption, large memory space
Applications: For applications including consumer information products and telecommunications instruments

8-bit Microcontrollers

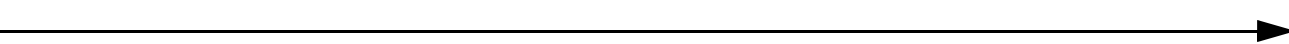
- F²MC-8L (MB89100 series, MB89500 series, MB89600 series, MB89800 series, and MB89900 series)
Features: Low voltage (+2.2V to +6.0V), low-power consumption
Applications: 8-bit microcontrollers for consumer markets
 - F²MC-8FX (MB95100 series)
Features: Low voltage (+1.8V to +5.5V), low-power consumption
Applications: consumer markets
-
- 

8-bit Proprietary F²MC-8L Family Features

F²MC-8L Family Features

- Minimum execution time: 0.32μs/12.5MHz, 0.4 μs/10MHz, 0.95 μs/4.2 MHz
- Operating voltage: +2.2 V to +6.0 V, operating frequency: 1 MHz to 10 MHz
- Software-switchable instruction cycle (4 speeds) provides low voltage, low-power consumption operation (clock gear function)
- Backup voltage in stop mode (voltage required to maintain RAM data): Min. +1.5 V
- Bitwise selectable pull-up resistors for each I/O port
- One-time PROM products support (by programming data) the same option settings as mask ROM products (the option settings are mask options for some products).
- Memory space: Max. 64 Kbytes

Memory space

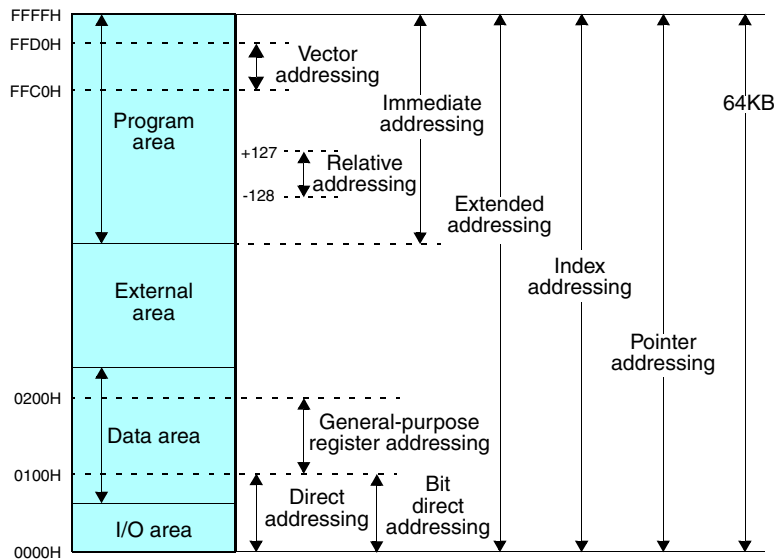

- Memory mapped I/O
 - Registers
- Dedicated registers
General-purpose registers: 8 × 8-bit per bank, Max. 32 banks

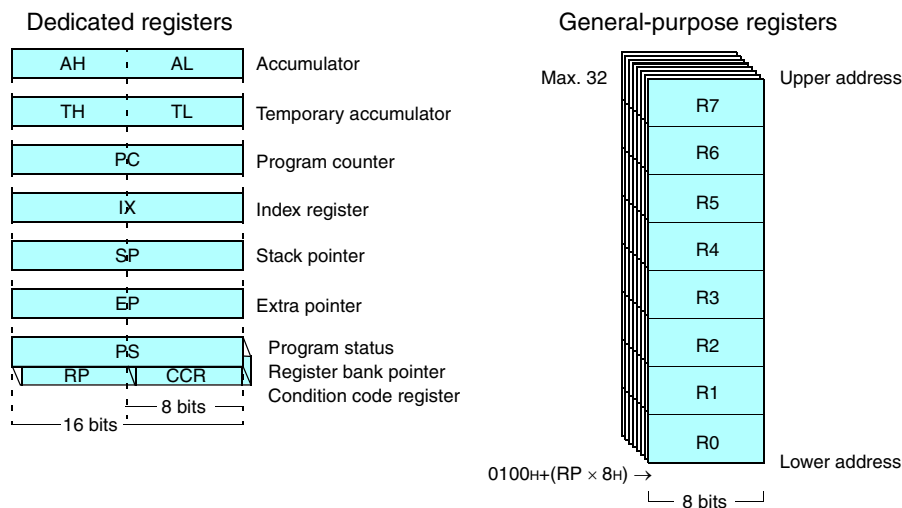

- Enhanced interrupt function (prioritized multiple interrupts)
- Powerful operation and transfer functions
- Multiplication and division instructions: 8-bit × 8-bit = 16-bit (7.6μs/10MHz), 16-bit ÷ 8-bit = 8-bit (8.4μs/10MHz)
- Data transfer: Max. 16-bit
- Number of instructions: 136

8-bit Proprietary F²MC-8L Family Product Range

F²MC-8L Family Product Range

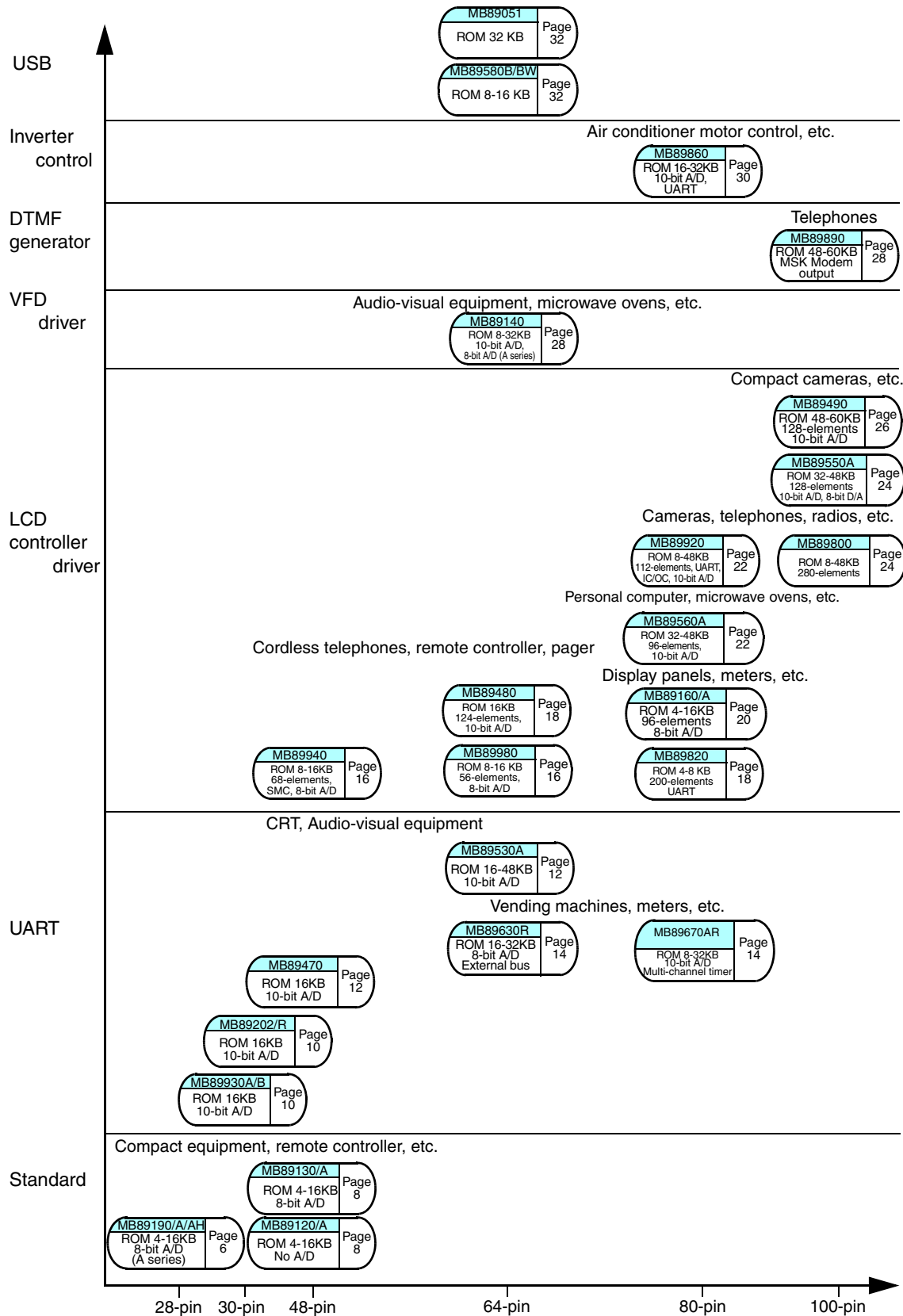

8-bit Proprietary F²MC-8L Family Standard Products

F²MC-8L Family Standard Products

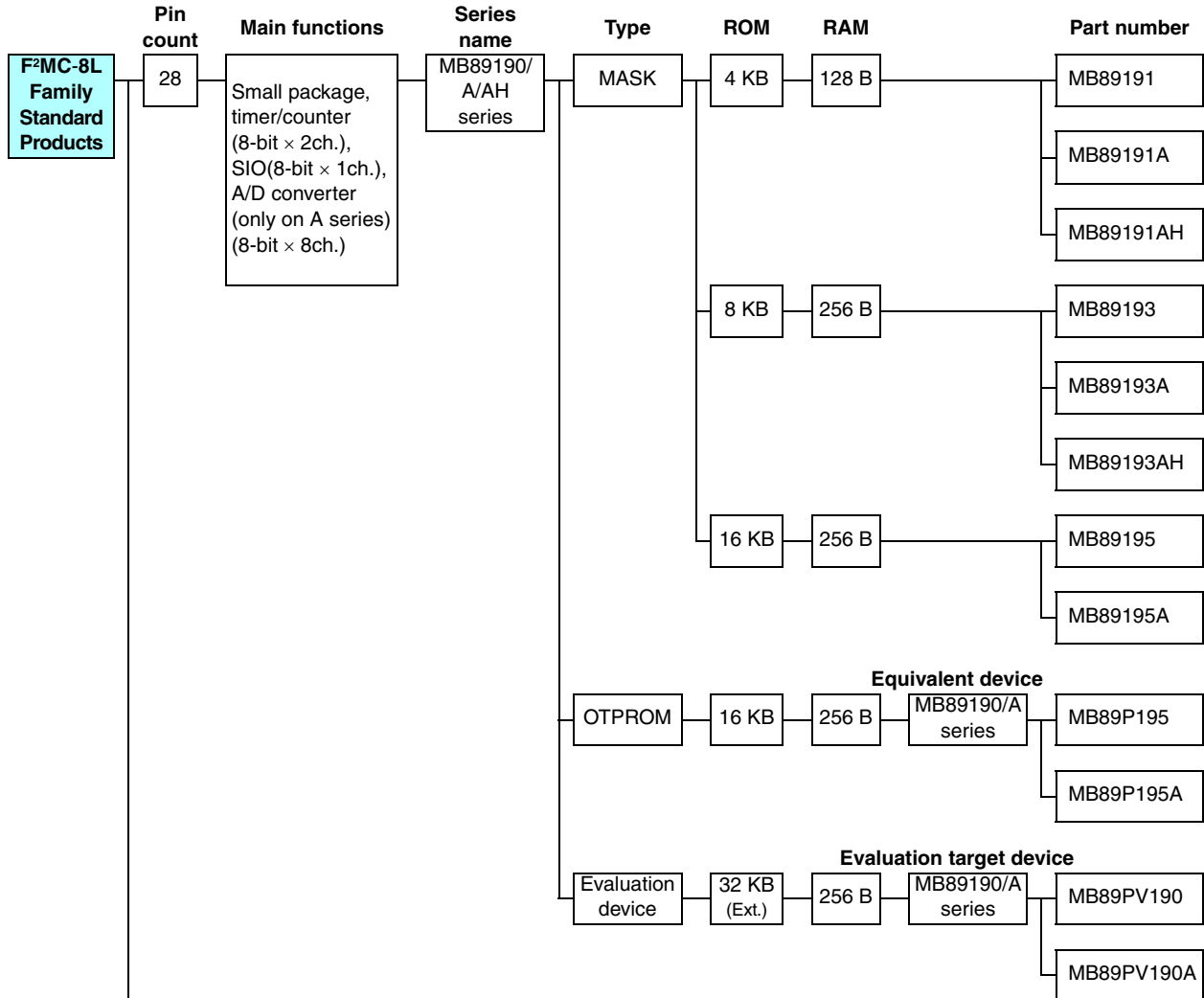

(Continued)

8-bit Proprietary F²MC-8L Family Standard Products

■ MB89190/190A/190AH Series

Standard products (small package)

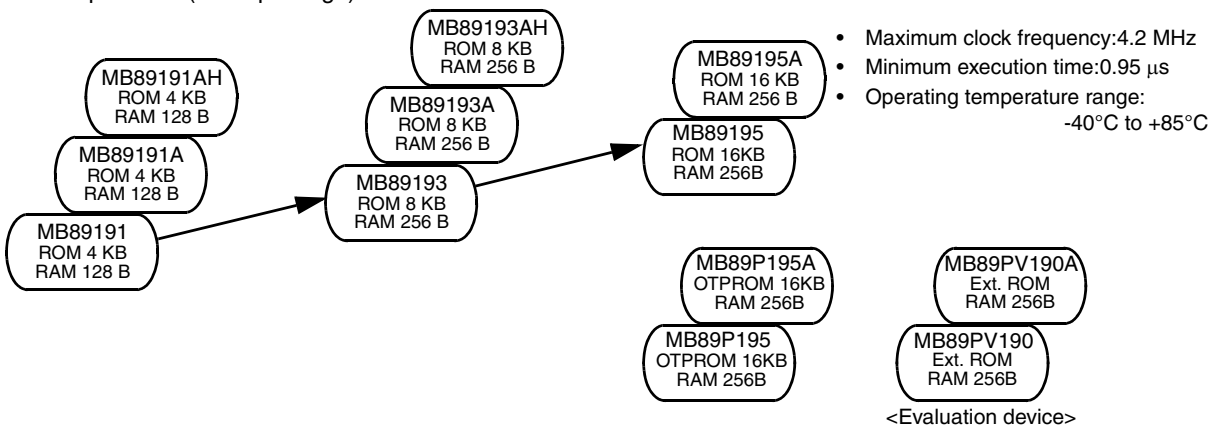

- Maximum clock frequency:4.2 MHz
- Minimum execution time:0.95 μs
- Operating temperature range:
-40°C to +85°C

Part number	Operating power supply voltage* (V)	Package				Functions
		SH-DIP	DIP	SOP	MQFP	
MB89191	+2.2 to +6.0	28P	28P	28P	-	I/O ports: 22 (20 on MB89190A series) Timebase timer (WDT): 20-bit × 1ch. Timer/counter: 8-bit × 2ch. (can operate as 16-bit × 1ch.) A/D converter: 8-bit × 8ch. (MB89190A series only) Remote controller carrier generator SIO: 8-bit × 1ch. Buzzer output Interrupts: 5 internal, 11 external Low-power consumption (stand-by functions) modes: Sleep, stop
MB89191A		28P	28P	28P	-	
MB89191AH		28P	28P	28P	-	
MB89193		28P	28P	28P	-	
MB89193A		28P	28P	28P	-	
MB89193AH		28P	28P	28P	-	
MB89195		28P	28P	28P	-	
MB89195A	28P	28P	28P	-		
MB89P195	+2.7 to +6.0	-	28P	28P	-	
MB89P195A		-	28P	28P	-	
MB89PV190		-	-	-	48C	
MB89PV190A		-	-	-	48C	

*: A/D = 3.5V to 6.0V

Packages: P - plastic, C - ceramic

8-bit Proprietary F²MC-8L Family Standard Products

(Continued)

	Main functions	Series name	Type	ROM	RAM	Part number			
48	Timer/counter (8-bit × 2ch.), SIO(8-bit × 1ch.)	MB89120/A series	MASK	4 KB	128 B	MB89121			
				8 KB	256 B	MB89123A			
				16 KB	256 B	MB89125A			
			OTEPROM	Equivalent device		4 KB	128 B	MB89121	MB89P131
				8 KB	256 B	MB89123A	MB89P133A		
				16 KB	512 B	MB89125A	MB89P135A		
			Evaluation device	Evaluation target device		32 KB (Ext.)	1 KB	MB89120/A series	MB89PV130A
			A/D converter (8-bit × 4ch.), timer/counter (8-bit × 2ch. or 16-bit × 1ch.), SIO(8-bit × 1ch.)	MB89130/A series	MASK	4 KB	128 B	MB89131	
						8 KB	256 B	MB89133A	
	16 KB	256 B				MB89135A			
	OTEPROM	Equivalent device			4 KB	128 B	MB89131	MB89P131	
		8 KB			256 B	MB89133A	MB89P133A		
16 KB		512 B			MB89135A MB89135L	MB89P135A			
Evaluation device	Evaluation target device				32 KB (Ext.)	1 KB	MB89130/A series	MB89PV130A	

8-bit Proprietary F²MC-8L Family Standard Products

■ MB89120/120A Series

Standard products (low cost)

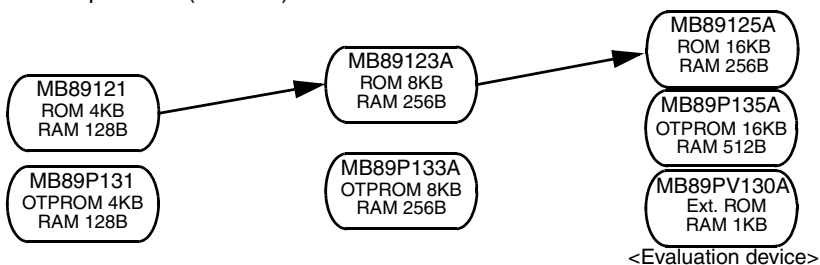

- Maximum clock frequency: 4.2 MHz (32.768 kHz)
- Minimum execution time: 0.95 μs to 1.53 μs (61 μs)
- Operating temperature range: -40°C to +85°C

Part number	Operating power supply voltage (V)	Package		Functions
		QFP	MQFP	
MB89121	+2.2 to +6.0	48P	-	I/O ports: 36 Timebase timer (WDT): 21-bit × 1ch. Timer/counter: 8-bit × 2ch. (can operate as 16-bit × 1ch.) Remote control carrier generator (on MB89123A/125A/P133A, not included on MB89121/P131) SIO: 8-bit × 1ch. Clock prescaler: 15-bit Buzzer output Interrupts: 4 internal, 3 external (MB89121/P131) 4 internal, 11 external (MB89123A/125A/ P133A) Low-power consumption (stand-by functions) modes: Sleep, watch, stop, sub
MB89123A		48P	-	
MB89125A		48P	-	
MB89P131	+2.7 to +6.0	48P	-	
MB89P133A		48P	-	
MB89P135A		48P	-	
MB89PV130A		-	48C	

Packages: P - plastic, C - ceramic

■ MB89130/130A Series

Standard products (built-in A/D converter, low cost)

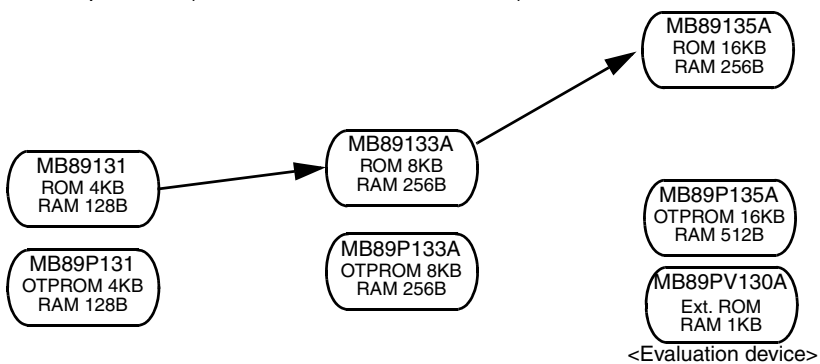

- Maximum clock frequency: 4.2 MHz (32.768 kHz)
- Minimum execution time: 0.95 μs to 1.53 μs (61 μs)
- Operating temperature range: -40°C to +85°C

Part number	Operating power supply voltage (V)	Package			Functions
		SH-DIP	QFP	MQFP	
MB89131	+2.2 to +6.0	-	48P	-	I/O ports: 36 Timebase timer (WDT): 21-bit × 1ch. Timer/counter: 8-bit × 2ch. (can operate as 16-bit × 1ch.) A/D converter: 8-bit × 4ch. Remote control carrier generator (on MB89133A/135A/P133A, not included on MB89131/P131) SIO: 8-bit × 1ch. Clock prescaler: 15-bit Buzzer output Interrupts: 5 internal, 3 external (MB89131/P131) 5 internal, 11 external (MB89133A/135A/P133A) Low-power consumption (stand-by functions) modes: Sleep, watch, stop, sub
MB89133A		48P	48P	-	
MB89135A		-	48P	-	
MB89P131	+2.7 to +6.0	-	48P	-	
MB89P133A		48P	48P	-	
MB89P135A		-	48P	-	
MB89PV130A		-	-	48C	

*: A/D = 3.5 V to 6.0 V

Packages: P - plastic, C - ceramic

8-bit Proprietary F²MC-8L Family Internal UART Products

F²MC-8L Family UART Products

	Pin count	Main functions	Series name	Type	ROM	RAM	Part number
F²MC-8L Family Internal UART Products	30	A/D converter (10bit × 8ch.) UART/SIO PWM timer (8bit × 1ch.) PPG timer (12bit × 1ch.) Timer counter with 8/16 bit capture	MB89930A/B series	MASK	16 KB	512 B	MB89935B
				OTPROM	16 KB	512 B	Equivalent device MB89930A/B series MB89P935B
				Evaluation device	16 KB (Ext.)	512 B	Evaluation target device MB89930A/B series MB89PV930A
	32/ 34	A/D converter (10 bit × 8 ch) , 8/16 bit timer counter with capture (1 ch) , UART/SIO (1 ch) , Interrupts (11ch) , PWM timer (8 bit × 1 ch) , PPG timer (12 bit × 1 ch) , Buzzer output	MB89202/R series	MASK	16 KB	512 B	MB89202 MB89202Y
				Flash	16 KB	512 B	MB89F202 MB89F202RA MB89F202Y MB89F202RAY
				Evaluation device		512 B	Evaluation target device MB89202R series MB89V201

(Continued)

8-bit Proprietary F²MC-8L Family Internal UART Products

■ MB89930A/B Series

Standard products (built-in UART, compact type)

MB89935B
ROM 16KB
RAM 512B

MB89P935B
OTPROM 16KB
RAM 512B

MB89PV930A
Ext. ROM
RAM 512B

<Evaluation device>

- Maximum clock frequency: 10 MHz
- Minimum execution time: 0.4 μs
- Operating temperature range: -40°C to +85°C

Part number	Operating power supply voltage (V)	Package		Functions
		SSOP	MQFP	
MB89935B	+2.2 to +5.5	30P	-	I/O ports: 21 A/D converter: 10-bit × 8 ch. UART/SIO: 1 ch.
MB89P935B	+3.0 to +5.5	30P	-	PWM timer: 8-bit × 1 ch. PPG timer: 12-bit × 1 ch. Timer counter with 8/16-bit capture
MB89PV930A	+2.7 to +5.5	-	48C	Timebase timer: 21-bit × 1 ch. Interrupts: 11 external Low-power consumption (stand-by functions) modes: Sleep, stop

Packages: P - plastic, C - ceramic

■ MB89202/R Series

Compact type

MB89202/Y
ROM 16KB
RAM 512B

MB89F202/RA
ROM 16KB
RAM 512B

MB89F202Y/RAY
ROM 16KB
RAM 512B

MB89V201
Ext. ROM
RAM 512B

<Evaluation device>
(with MB2144-230)

- Maximum clock frequency: 12.5 MHz
- Minimum execution time: 0.32 μs
- Operating temperature range: -40 to +85 °C

Part number	Operating power supply voltage (V)	Package			Functions
		SH-DIP	SSOP	QFP	
MB89202	+2.2 to +5.5	32P	—	—	I/O ports: 27 A/D converter: 10-bit × 8 ch. Timer counter with 8/16-bit capture : 1 ch.
MB89202Y		—	34P	—	
MB89F202	+3.5 to +5.5	32P	—	—	Timebase timer: 21 bit × 1 ch. PWM timer: 8-bit × 1 ch. PPG timer: 12-bit × 1 ch. UART/SIO : 1 ch. Interrupts: 11 external Buzzer output : 1 ch. Low-power consumption (stand-by functions) modes: Sleep, stop
MB89F202RA		32P	—	—	
MB89F202Y		—	34P	—	
MB89F202RAY		—	34P	—	
MB89V201	+2.7 to +5.5	—	—	64P	Evaluation device: with MB2144-230

Packages: P - plastic

8-bit Proprietary F²MC-8L Family Internal UART Products

(Continued)

Pin count	Main functions	Series name	Type	ROM	RAM	Part number		
48	A/D converter (10bit × 8ch.) Timer/counter (8 bit × 4 ch., can operate as 16-bit) UART/SIO (2 ch.) Interrupts (9 ch.) PWM timer (8 bit × 1 ch.) PWC timer (8 bit × 1 ch.) Clock prescaler Buzzer output	MB89470 series	MASK	16 KB	512 B	MB89475		
			Equivalent device					
			OTEPROM	16 KB	512 B	MB89475	MB89P475	
			Evaluation target device					
			Evaluation device	16 KB (Ext.)	1 KB	MB89470 series MB89PV470		
64	UART, SIO, UART/SIO, I ² C bus interface (MB89537AC/538AC/P538/PV530), PWM timer (8-bit × 2ch.), timer/counter (16-bit × 1ch.), PWC timer (8-bit × 2ch.), PPG timer (12-bit × 2ch., 6-bit × 1ch.), A/D converter (10-bit × 8ch.)	MB89530A series	MASK	16 KB	512 B	MB89535A		
				32 KB	1 KB	MB89537A		
						MB89537AC		
						48 KB	2 KB	MB89538A
								MB89538AC
			Equivalent device					
			OTEPROM	48 KB	2 KB	MB89530A series	MB89P538	
			Flash	48 KB	2 KB	MB89530A series	MB89F538	
							MB89F538L	
			Evaluation target device					
			Evaluation device	48 KB (Ext.)	2 KB	MB89530A series MB89PV530		

(Continued)

(Continued)

8-bit Proprietary F²MC-8L Family Internal UART Products

■ MB89470 Series

Standard products (built-in UART, compact type)

MB89475
ROM 16 KB
RAM 512 B

MB89P475
OTPROM 16 KB
RAM 512 B

MB89PV470
Ext. ROM
RAM 1 KB

<Evaluation device>

- Maximum clock frequency: 12.5 MHz (32.768 kHz)
- Minimum execution time: 0.32 μs (61 μs)
- Operating temperature range: -40°C to +85°C

Part number	Operating power supply voltage (V)	Package		Functions
		LQFP	MQFP	
MB89475	+2.2 to +5.5	48P	-	I/O ports: 39 A/D converter: 10-bit × 8 ch. Timer/counter: 8-bit × 4 ch. (16-bit × 2ch.) Timebase timer (WDT): 21-bit × 1 ch. PWM timer: 8-bit × 1 ch. PWC timer: 8-bit × 1 ch. UART/SIO: 2ch. Interrupts: 5 ch. (Level) + 4 ch. (edges) Clock prescaler Buzzer output Low-power consumption (stand-by functions) modes: Sleep, stop, sub, clock
MB89P475	+3.5 to +5.5	48P	-	
MB89PV470	+2.7 to +5.5	-	48C	

Packages: P - plastic, C - ceramic

■ MB89530A Series

Standard products (telephones, mobileproducts, etc.)

MB89F538
Flash memory 48KB
RAM 2KB

MB89F538L
Flash memory 48KB
RAM 2KB

MB89537AC
ROM 32KB
RAM 1KB

MB89538AC
ROM 48KB
RAM 2KB

MB89P538
OTPROM 48KB
RAM 2KB

MB89535A
ROM 16KB
RAM 512B

MB89537A
ROM 32KB
RAM 1KB

MB89538A
ROM 48KB
RAM 2KB

MB89PV530
Ext. ROM
RAM 2KB

<Evaluation device>

- Maximum clock frequency: 12.5 MHz (32.768 kHz)
- Minimum execution time: 0.32 μs (61 μs)
- Operating temperature range: -40°C to +85°C

Part number	Operating power supply voltage (V)	Package					Functions
		SDIP	QFP	LQFP	BCC	MQFP	
MB89535A	+2.2 to +5.5	64P	64P	64P (0.5 mm pitch, 0.65 mm pitch)	64P	-	I/O ports: 53 (52: MB89F538/F538L) Timebase timer (WDT): 21-bit × 1ch. Timer/counter: 16bit × 1ch. PWM timer: 8-bit × 2ch. PWC timer: 8-bit × 1ch. PPG timer: 12-bit × 2ch., 6-bit × 1ch. A/D converter: 10-bit × 8ch. I ² C bus interface (built into MB89537AC/538AC/P538/F538L/ PV530) SIO/UART × 1ch., SIO × 1ch., UART × 1ch UART/Serial interface Interrupts: 12 external Low-power consumption (stand-by functions) modes: Sleep, stop, watch, sub
MB89537A		64P	64P		-	-	
MB89537AC		64P	64P		-	-	
MB89538A		64P	64P		-	-	
MB89538AC		64P	64P		-	-	
MB89F538	+3.5 to +5.5	64P	64P	64P (0.65 mm pitch)	-	-	
MB89F538L	+2.4 to +3.6	64P	64P		64P	-	
MB89P538	+2.7 to +5.5	64P	64P	-	-	-	
MB89PV530		64C	-	-	-	64C	

Packages: P - plastic, C - ceramic

8-bit Proprietary F²MC-8L Family Internal UART Products

(Continued)

(Continued)

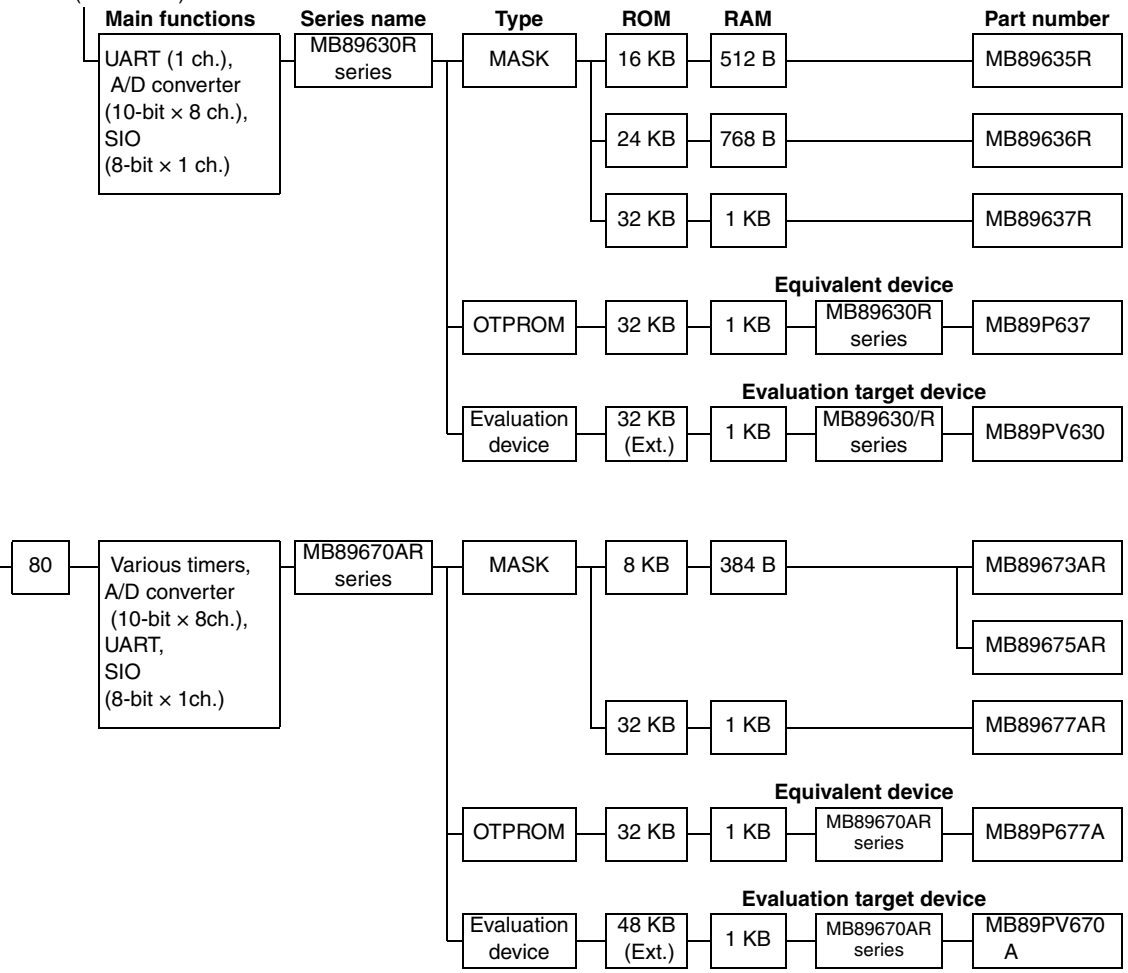

8-bit Proprietary F²MC-8L Family Internal UART Products

■ MB89630R Series

Standard products (A/D converter, built-in UART)

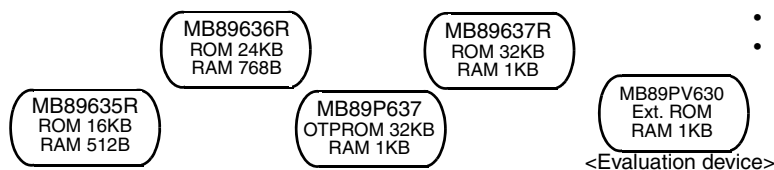

- Maximum clock frequency: 10 MHz (32.768 kHz)
- Minimum execution time: 0.4 μs to 6.4 μs (61 μs)
- Operating temperature range: -40°C to +85°C

Part number	Operating power supply voltage* (V)	Package					Functions
		SH-DIP	QFP	LQFP	MDIP	MQFP	
MB89635R	+2.2 to +6.0	64P	64P	64P	-	-	I/O ports: 53 Timebase timer (WDT): 21-bit × 1ch. Timer/counter: 16-bit × 1ch. PWM timer: 8-bit × 2ch. PWC timer: 8-bit × 1ch. A/D converter: 10-bit × 8ch. SIO: 8-bit × 1ch. UART: 8-bit × 1ch. (switchable between two I/O ports) Clock prescaler: 15-bit Buzzer output Interrupts: 10 internal, 4 external Low-power consumption (stand-by functions) modes: Sleep, watch, stop, sub
MB89636R		64P	64P	64P	-	-	
MB89637R		64P	64P	64P	-	-	
MB89P637	+2.7 to +6.0	64P	64P	-	-	-	
MB89PV630		-	-	-	64C	64C	

*: A/D = 3.5V to 6.0V

Packages: P - plastic, C - ceramic

■ MB89670AR Series

Standard products (multi function timer)

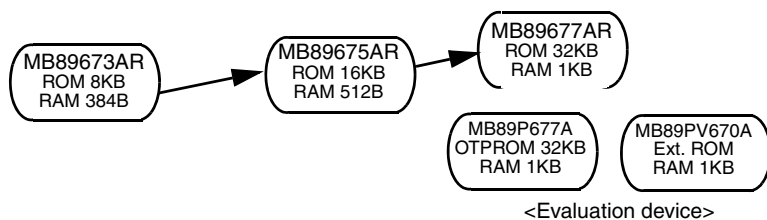

- Maximum clock frequency: 10 MHz
- Minimum execution time: 0.4 μs to 6.4 μs
- Operating temperature range: -40°C to +85°C

Part number	Operating power supply voltage* (V)	Package			Functions
		QFP	LQFP	MQFP	
MB89673AR	+2.2 to +6.0	80P	80P	-	I/O ports: 69 Timebase timer (WDT): 21-bit × 1ch. Timer/counter: 16-bit × 2ch. (16-bit × 1ch. + 8-bit × 2ch.) Buzzer output PWM timer: 8-bit × 6ch. (MB89673AR/675AR/P677A) Up/down counter: 8-bit × 2ch. (16-bit × 1ch.) A/D converter: 10-bit × 8ch. SIO: 8-bit × 1ch. UART: 8-bit × 1ch. (switchable between two I/O ports) Interrupts: 10 internal, 8 external Low-power consumption (stand-by functions) modes: Sleep, stop
MB89675AR		80P	80P	-	
MB89677AR		80P	80P	-	
MB89P677A	+2.7 to +6.0	80P	80P	-	
MB89PV670A		-	-	80C	

*: A/D = 3.5V to 6.0V

Packages: P - plastic, C - ceramic

F²MC-8L Family Internal LCD Controller/Driver Products

	Pin count	Main functions	Series name	Type	ROM	RAM	Part number		
F²MC-8L Family Internal LCD Controller/Driver Products	48	LCD controller/driver (4com. × 17seg.), stepping motor-control(8-bit PWM timer× 2ch.), PWM timer (8-bit × 2ch.), interval timer (8-bit × 2ch.or16-bit × 1ch.), A/D converter (8-bit × 2ch.), low-voltage detection reset, external voltage watch interrupt	MB89940 series	MASK	8 KB	512 B	MB89943		
					16 KB	512 B	MB89945		
				OTEPROM	16 KB	512 B	MB89943	MB89P945	
				Evaluation device	32 KB (Ext.)	1 KB	MB89940 series	MB89PV940	
		64	LCD controller/driver (14seg. × 4com.), A/D converter (8-bit × 4ch.), Buzzer output, Timer/counter (8-bit× 2ch.) (16-bit× 1ch.), PWM timer, (8-bit× 2ch.), Remote controlled carrier generator	MB89980 series	MASK	8 KB	256 B	MB89983	
	OTEPROM				16 KB	512 B	MB89980 series	MB89P985	
	Evaluation device				32 KB (Ext.)	512 B	MB89980 series	MB89PV980	

(Continued) (Continued)

■ MB89940 Series

Standard products (LCD controller/driver, built-in stepping motor controller)

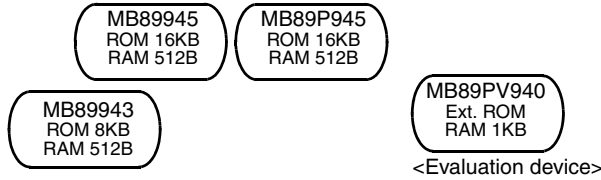

- Maximum clock frequency: 8 MHz
- Minimum execution time: 0.5 μs
- Operating temperature range: -40°C to +85°C

Part number	Operating power supply voltage (V)	Package		Functions
		QFP	MQFP	
MB89943	+3.5 to +5.5	48P	-	I/O ports: 37 Timebase timer (WDT): 21-bit × 1ch. Interval timer: 8-bit × 2ch. (can operate as 16-bit × 1ch.) PWM timer: 8-bit × 2ch. Stepping motor control: 8-bit PWM timer × 2ch. A/D converter: 8-bit × 2ch. LCD controller/driver: 68 elements, 2 to 4 common, 10 to 17 segments 17 × 4-bit LCD display RAM Low-voltage detection reset External voltage watch interrupt Interrupts: 5 internal, 3 external Low-power consumption (stand-by functions) modes: Sleep, stop
MB89945		48P	-	
MB89P945		48P	-	
MB89PV940		-	48C	

Packages: P - plastic, C - ceramic

■ MB89980 Series

Standard products (built-in LCD controller/driver)

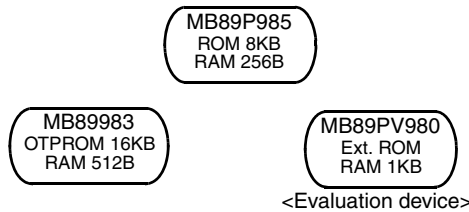

- Maximum clock frequency: 4.2 MHz (32.768 kHz)
- Minimum execution time: 0.95 μs
- Operating temperature range: - 40°C to +85 °C

Part number	Operating power supply voltage * (V)	Package		Functions
		LQFP	MQFP	
MB89983	+2.2 to +6.0	64P	-	I/O ports: 47 Timebase timer (WDT): 21-bit × 1ch. Timer/counter: 8-bit × 2ch.(can operate as 16-bit × 1ch.) PWM timer: 8-bit × 2ch. Buzzer output Remote controlled carrier generator LCD controller/driver:56 elements, 2 to 4 common, 4 to 14segments 7 × 8-bit LCD display RAM Interrupts: 12 external Low-power consumption (stand-by functions) modes: Sleep, watch, stop, sub
MB89P985	+2.7 to +6.0	64P	-	
MB89PV980		-	64C	

*: A/D = 3.5V to 6.0V

Packages: P - plastic, C - ceramic

8-bit Proprietary F²MC-8L Family

Internal LCD Controller/Driver Products

	(Continued)	(Continued)	Series name	Type	ROM	RAM	Part number				
	<p>Main functions</p> <p>LCD controller/driver (31seg. × 4com.), A/D converter (10-bit × 4ch.), Timer/counter (8-bit × 4ch. can operate as 16-bit), UART/SIO (1ch.), Interrupts (12ch.), PWM timer, (8-bit × 1ch.), PWC timer, (8-bit × 1ch.), PPG timer, (6-bit × 1ch.), Clock prescaler, Buzzer output</p>	<p>MB89480 series</p>	MASK	16 KB	512 B	MB89485					
						MB89485L					
				Equivalent device		16 KB	512 B	MB89980 series	MB89P485		
				MB89980 series	MB89P485L						
					Evaluation device		1 KB	MB89480 series	MB89PV480		
			<p>80</p>	<p>MB89820 series</p>	MASK	4 KB	128 B	MB89821			
								8 KB	256 B	MB89823R	
						16 KB	256 B	MB89825			
							OTPROM	16 KB	256 B	MB89820 series	MB89P825
							Evaluation device	32 KB (Ext.)	1 KB	MB89820 series	MB89PV820
	Equivalent device										
	Evaluation target device										
(Continued)	(Continued)										

■ MB89480 Series

Standard products (built-in LCD controller/driver)

MB89485
ROM 16 KB
RAM 512 B

MB89P485
OTPROM 16 KB
RAM 512 B

MB89485L
ROM 16 KB
RAM 512 B

MB89P485L
OTPROM 16 KB
RAM 512 B

MB89PV480
Ext. ROM
RAM 1KB

- Maximum clock frequency: 12.5 MHz (32.768 kHz)
- Minimum execution time: 0.32 μs (61 μs)
- Operating temperature range: - 40°C to +85 °C

Part number	Operating power supply voltage (V)	Package		Functions
		LQFP	SH-DIP	
MB89485L	+2.2 to +3.6	64P (0.65 mm pitch)	64P	I/O ports: 42 LCD controller/driver: 124 elements, 2 to 4 common, 8 to 31 segments, 4 bias power supplies, 31 × 4-bit LCD display RAM Selectable as a mask option A/D converter: 10-bit × 4ch. Timer/counter: 8-bit × 4ch. (16-bit × 2ch.) Timebase timer (WDT): 21-bit × 1ch. PWM timer: 8-bit × 1ch. PWC timer: 8-bit × 1ch. PPG timer: 6-bit × 1ch. UART/SIO: 1ch. Interrupts: 8ch. (Level) +4ch. (edges) Clock prescaler Buzzer output Low-power consumption (stand-by functions) modes: Sleep, stop, sub, watch
MB89485	+2.2 to +5.5		64P	
MB89P485L	+2.7 to +3.6		64P	
MB89P485	+3.5 to +5.5		64P	
MB89PV480	+2.7 to +5.5	-	64C	

Packages: P - plastic, C - ceramic

■ MB89820 Series

Standard products (LCD controller/driver, built-in UART)

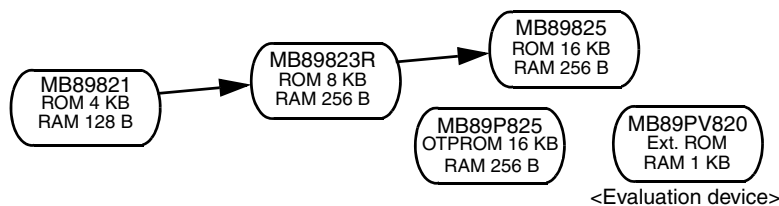

- Maximum clock frequency: 5 MHz
- Minimum execution time: 0.8 μs
- Operating temperature range: -40°C to +85°C

Part number	Operating power supply voltage (V)	Package		Functions
		LQFP	MQFP	
MB89821	+2.2 to +6.0	80P	-	I/O ports: 32 Timebase timer (WDT): 20-bit × 1ch. PWM timer: 8-bit × 1ch. PWC timer: 8-bit × 1ch. LCD controller/driver: 200 elements, 2 to 4 common, 34 to 50 segments, 3 bias power supplies, 8-bit × 25 LCD display RAM SIO: 8-bit × 1ch. UART: 5-, 7-, 9-bit × 1ch. Interrupts: 5 internal, 2 external Low-power consumption (stand-by functions) modes: Sleep, stop
MB89823R		80P	-	
MB89825		80P	-	
MB89P825	+2.7 to +6.0	80P	-	
MB89PV820		-	80C	

Packages: P - plastic, C - ceramic

8-bit Proprietary F²MC-8L Family

Internal LCD Controller/Driver Products

(Continued)

(Continued)

Main functions	Series name	Type	ROM	RAM	Part number		
LCD controller/ driver(24seg. x 4com.), A/D converter (8-bit x 8ch.), PWM timer (8-bit x 2ch.)	MB89160/A series	MASK	4 KB	128 B	MB89161		
					MB89161A		
			8 KB	256 B	MB89163		
					MB89163A		
			16 KB	512 B	MB89165		
					MB89165A		
				OTEPROM	16 KB	512 B	Equivalent device MB89160 series MB89P165
				EPROM	16 KB	512 B	Equivalent device MB89160 series MB89W165
				Evaluation device	32 KB (Ext.)	512 B	Evaluation target device MB89160 series MB89PV160

(Continued)

(Continued)

■ MB89160/160A Series

Standard products (LCD controller/driver, built-in A/D converter)

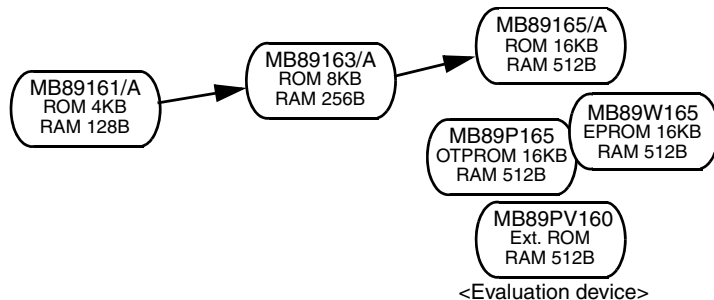

- Maximum clock frequency: 4.2 MHz (32.768 kHz)
- Minimum execution time: 0.95 μs to 15.3 μs (61 μs)
- Operating temperature range: -40°C to +85°C

Part number	Operating power supply voltage* (V)	Package			Functions
		QFP	LQFP	MQFP	
MB89161	+2.2 to +6.0	80P	80P	-	I/O ports: Max. 54 (depends on the number of segments option) Timebase timer (WDT): 21-bit × 1ch. Timer/counter: 8-bit × 2ch. (can operate as 16-bit × 1ch. event) PWM timer: 8-bit × 2ch. A/D converter: 8-bit × 8ch. LCD controller/driver: 96 elements, 2 to 4 common, 8 to 24 segments, 4 bias power supplies, 8-bit × 12 LCD display RAM, Booster circuit (MB89161A/163A/165A) No booster circuit (MB89161/163/165/PV160) (Selectable as a mask option on the MB89P165 and MB89W165)
MB89161A		80P	80P	-	
MB89163		80P	80P	-	
MB89163A		80P	80P	-	
MB89165		80P	80P	-	
MB89165A		80P	80P	-	
MB89P165	+2.7 to +6.0	80P	80P	-	
MB89W165		80C	-	-	
MB89PV160		-	-	80C	

*: A/D = 3.5V to 6.0V

Packages: P - plastic, C - ceramic

8-bit Proprietary F²MC-8L Family

Internal LCD Controller/Driver Products

(Continued)

(Continued)

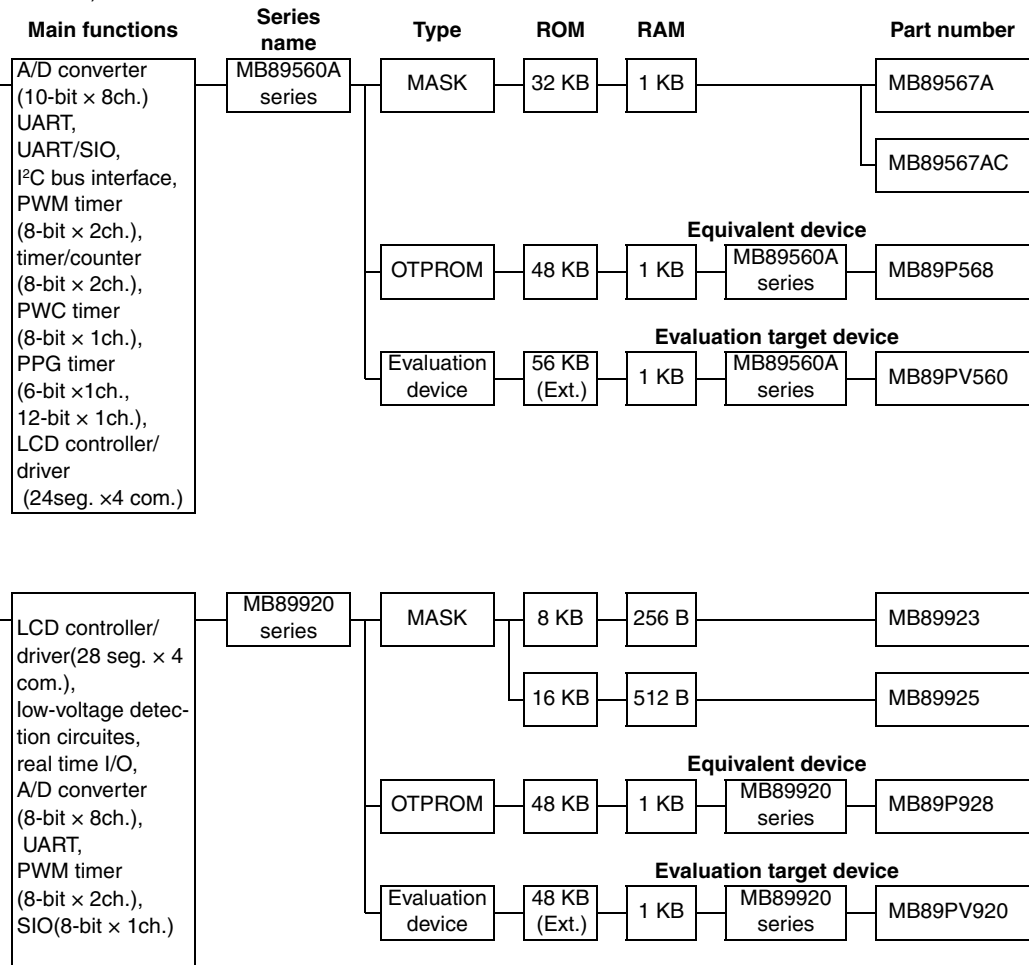

(Continued)

■ MB89560A Series

Standard products (personal computer, microwave ovens, etc.)

MB89567A/AC
ROM 32KB
RAM 1KB

MB89P568
OTPROM 48KB
RAM 1KB

MB89PV560
Ext. ROM
RAM 1KB

<Evaluation device>

- Maximum clock frequency: 12.5 MHz (32.768kHz)
- Minimum execution time: 0.32 μs (61μs)
- Operating temperature range: -40°C to +85°C

Part number	Operating power supply voltage (V)	Package				Functions
		QFP	LQFP (0.5 mm, □12 × 12 mm)	LQFP (0.65 mm, □14 × 14 mm)	MQFP	
MB89567A	+2.2 to +5.5	80P	80P	80P	-	I/O ports: 50 Timebase timer (WDT): 21-bit × 1ch. Timer/counter: 8-bit × 2ch. (can operate as 16-bit) PWM timer: 8-bit × 2ch. PWC timer: 8-bit × 1ch. PPG timer: 6-bit × 1ch., 12-bit × 1ch. A/D converter: 10-bit × 8ch. I ² C bus interface (built into MB89567C/567HC/P568/PV560) UART: 6, 7, 8-bit × 1ch. SIO: 8-bit × 1 ch. UART/SIO: 1 ch. LCD controller/driver: 96 elements, 2 to 4 common, 8 to 24 segments, 12 × 8-bit LCD display RAM, static, duty Booster circuit (Selected as an option) (MB89560/560A) No booster circuit (MB89560H) Interrupts: 10 internal, 12 external Low-power consumption (stand-by functions) modes: Sleep, watch, stop, sub
MB89567AC		80P	80P	80P	-	
MB89P568	+2.7 to +5.5	80P	80P	80P	-	
MB89PV560		-	-	-	80C	

Packages: P - plastic, C - ceramic

■ MB89920 Series

Standard products (LCD controller/driver, built-in A/D converter)

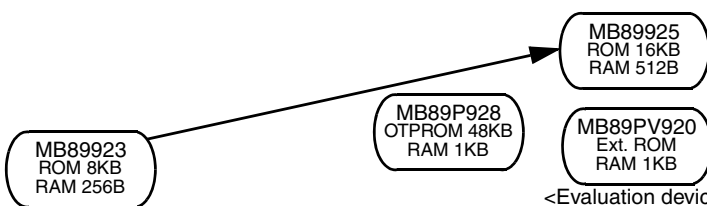

- Maximum clock frequency: 8 MHz
- Minimum execution time: 0.5 μs
- Operating temperature range: -40°C to +85°C

Part number	Operating power supply voltage* (V)	Package		Functions
		QFP	MQFP	
MB89923	+2.2 to +6.0	80P	-	I/O ports: 69 Timebase timer (WDT): 20-bit × 1ch. PWM timer: 8-bit × 2ch. A/D converter: 10-bit × 8ch. LCD controller/driver: 112 elements, 2 to 4 common, 16 to 28 segments, 3 bias power supplies, 8-bit × 14 LCD display RAM UART: 7 to 8-bit × 1ch. Low-voltage detection reset SIO: 8-bit × 1ch. Buzzer output Interrupts: 10 internal, 4 external Realtime I/O Low-power consumption (stand-by functions) modes: Sleep, stop
MB89925		80P	-	
MB89P928	+2.7 to +6.0	80P	-	
MB89PV920		-	80C	

*: A/D = 3.5V to 6.0V

Packages: P - plastic C - ceramic

8-bit Proprietary F²MC-8L Family

Internal LCD Controller/Driver Products

(Continued)

Pin count	Main functions	Series name	Type	ROM	RAM	Part number				
100	UART, PWM timer (8-bit × 1ch.), PWC timer (8-bit × 1ch.), Timebase timer (21-bit × 1ch.), LCD controller/ driver(70 seg. × 4 com.)	MB89800 series	MASK	8 KB	256 B	MB89803				
				16 KB	512 B	MB89805				
			OTPROM	48 KB	2 KB	Equivalent device		MB89P808		
						MB89800 series				
			Evaluation device	2 KB	Evaluation target device		MB89PV800			
					MB89800 series					
			A/D converter (10-bit × 8ch.), D/A converter (8-bit × 2ch.), UART or SIO, UART/SIO, PWM timer (8-bit × 2ch.), timer/counter (8-bit × 2ch.) × 2 (16-bit × 1ch.), PWC timer (8-bit × 1ch.), PPG timer (6-bit × 1ch.), LCD controller (32seg. × 4 com.)	MB89550A series	MASK	32 KB	1 KB	MB89557A		
						48 KB	2 KB	MB89558A		
					OTPROM	48 KB	2 KB	Equivalent device		MB89P558A
								MB89557A MB89558A		
Evaluation device	32 KB (Ext.)	2 KB			Evaluation target device		MB89PV550A			
					MB89550A series					

(Continued)

8-bit Proprietary F²MC-8L Family

Internal LCD Controller/Driver Products

■ MB89800 Series

Standard products (LCD controller/driver)



- Maximum clock frequency: 10 MHz
- Minimum execution time: 0.4 μs/5V
- Operating temperature range: -40°C to +85°C

Part number	Operating power supply voltage (V)	Package			Functions
		LQFP	QFP	MQFP	
MB89803	+2.2 to +6.0	100P	100P	-	I/O ports: 32 Timebase timer (WDT): 21-bit × 1ch. PWM timer: 8-bit × 1ch. PWC timer: 8-bit × 1ch. UART: 1ch. LCD controller/driver: 280 elements, 4 common, 70 segments, 4-bit × 70 LCD display RAM, vias supply 3 Interrupts: 5 external Low-power consumption (stand-by functions) modes: Sleep, stop
MB89805		100P	100P	-	
MB89P808	+2.7 to +6.0	100P	100P	-	
MB89PV800		-	-	100C	

Packages: P - plastic C - ceramic

■ MB89550A Series

Standard products (compact camera, etc.)



- Maximum clock frequency: 12.5 MHz (32.768kHz)
- Minimum execution time: 0.32 μs (61μs)
- Operating temperature range: -40°C to +85°C

Part number	Operating power supply voltage (V)	Package			Functions
		LQFP	TQFP	MQFP	
MB89557A	+2.2 to +3.6 ^{*1} +2.2 to +5.5 ^{*2}	100P	100P	-	I/O ports: 66 Timebase timer (WDT): 21-bit × 1ch. Timer/counter: 8-bit×4ch.(16-bit × 2ch.), 16-bit×1ch. PWM timer: 8-bit × 2ch. PWC timer: 8-bit × 1ch. PPG timer: 16-bit × 1ch. A/D converter: 10-bit × 8ch. D/A converter: 8-bit × 2ch. LCD controller/driver: 128 elements, 2 to 4 common, 8 to 32 segments, 1/2, 1/3 bias power supplies, 32 × 4-bit LCD display RAM, booster circuit (selected as an option), static, duty UART/SIO: 8-bit × 2ch. Interrupts: 10 internal, 5 external Low-power consumption (stand-by functions) modes: Sleep, watch, sub
MB89558A		100P	100P	-	
MB89P558A	+2.7 to +5.5	100P	100P	-	
MB89PV550A		-	-	100C	

*1: Power supply for logic at Vcc1

*2: Power supply for I/O at Vcc2

Packages: P - plastic, C - ceramic

8-bit Proprietary F²MC-8L Family

Internal LCD Controller/Driver Products

(Continued)

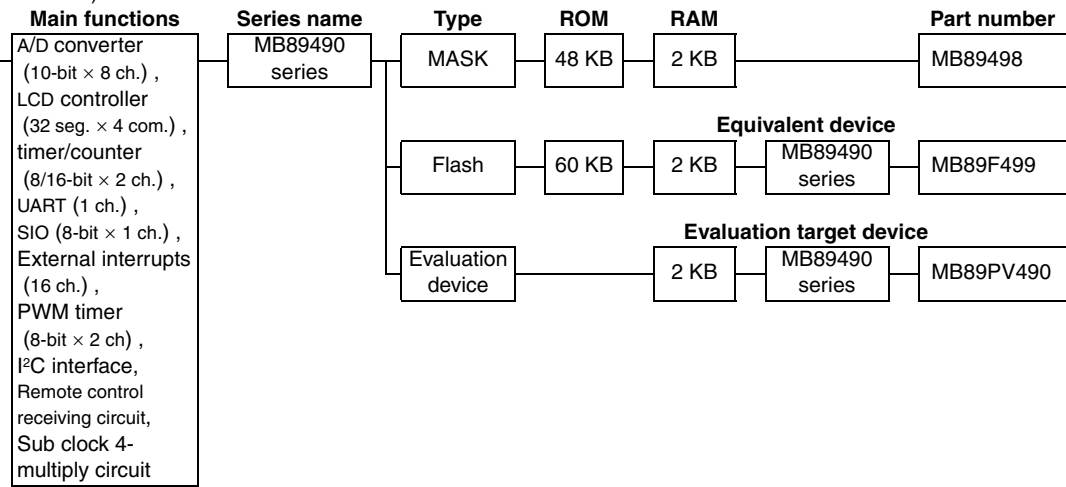

■ MB89490 Series

Standard products (Remote control receiving circuit, Sub clock multiply circuit)

MB89498
ROM 48 KB
RAM 2 KB

MB89F499
Flash 60 KB
RAM 2 KB

MB89PV490
Ext. ROM
RAM 2 KB

<Evaluation device>

- Maximum clock frequency: 12.5 MHz
- Minimum execution time: 0.32 μs
- Operating temperature range: -40°C to +85 °C

Part number	Operating power supply voltage (V)	Package			Functions
		QFP	LQFP	MQFP	
MB89498	+2.2 to +3.6	100P	100P	-	I/O ports: 66 A/D converter: 10-bit × 8 ch. Timer/counter: 8-bit × 2 ch. (16-bit × 1 ch.) Timebase timer (WDT): 21-bit × 1 ch. Watch timer: 1 ch. PWM timer : 8-bit × 2 ch.
MB89F499	+2.7 to +3.6	100P	100P	-	LCD controller/driver: 128 elements, 2 to 4 common, 16 to 32 segments, 1/2, 1/3 bias power supplies, 32 × 4-bit LCD display RAM
MB89PV490		-	-	100C	UART : 8-bit × 1 ch. SIO : 8-bit × 1 ch. I ² C interface: 1 ch. Interrupts: edge 8 ch./level 8 ch. Remote control receiving circuit Sub clock 4-multiply circuit Low-power consumption (stand-by functions) modes: Sleep, stop, watch, sub

Packages: P - plastic, C - ceramic

F²MC-8L Family VFD Driver Products

	Pin count	Main functions	Series name	Type	ROM	RAM	Part number	
F ² MC-8L Family VFD Driver Products	64	Vacuum fluorescent display driver, A/D converter (10-bit × 12ch.), PWM timer (8-bit × 1ch.), MPG timer (12-bit × 1ch.), timer/counter (8-bit × 2ch., can operate as 16-bit), SIO(8-bit × 1ch.)	MB89140 series	MASK	8 KB	256 B	MB89143A	
					12 KB	256 B	MB89144A	
					16 KB	512 B	MB89145	
					24 KB	768 B	MB89146	
				OTPROM	32 KB	1 KB	MB89140 series	MB89P147
				Evaluation device	32 KB (Ext.)	1 KB	MB89140 series	MB89PV140

F²MC-8L Family DTMF Generator Products

	Pin count	Main functions	Series name	Type	ROM	RAM	Part number	
F ² MC-8L Family Internal DTMF Generator Products	100	DTMF generator, A/D converter (8-bit × 8ch.), SIO, PWM timer, software modem	MB89890 series	MASK	48 KB	1.5 KB	MB89898	
					60 KB	2 KB	MB89899	
				OTPROM Evaluation device	60 KB	2 KB	MB89890 series	MB89P899
				Evaluation device	60 KB (Ext.)	2 KB	MB89890 series	MB89PV890

■ MB89140 Series

Standard products (vacuum fluorescent display driver, 10-bit A/D converter, built-in inverter macro)

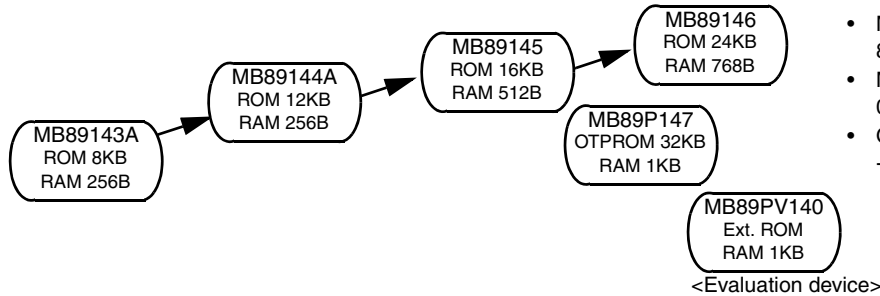

- Maximum clock frequency: 8 MHz (32.768 kHz)
- Minimum execution time: 0.5 μs to 8.0 μs (61 μs)
- Operating temperature range: -40°C to +85°C

Part number	Operating power supply voltage (V)	Package				Functions
		SDIP	QFP	MDIP	MQFP	
MB89143A	+4.0 to +6.0	64P	-	-	-	I/O ports: 55 High withstand voltage ports: 25 Timebase timer (WDT): 21-bit × 1ch. Timer/counter: 8-bit × 2ch. (16-bit × 1ch.) PWM timer: 8-bit × 1ch.(MB89143 except) MPG timer: 12-bit × 1ch.(MB89143 except) A/D converter: 10-bit × 12ch.(MB89143: 8-bit × 8ch.) SIO: 8-bit × 1ch. Clock prescaler: 15-bit Buzzer output Interrupts: 10 internal, 2 external Low-power consumption (stand-by functions) modes: Sleep, watch, stop, sub
MB89144A		64P	-	-	-	
MB89145	+2.7 to +6.0 *	64P	64P	-	-	
MB89146		64P	64P	-	-	
MB89P147		64P	64P	-	-	
MB89PV140		-	-	64C	64C	

*: A/D = 3.5V to 6.0V

Packages: P - plastic, C - ceramic

■ MB89890 Series

Standard products (DTMF generator, built-in MSK modem 100-pin)

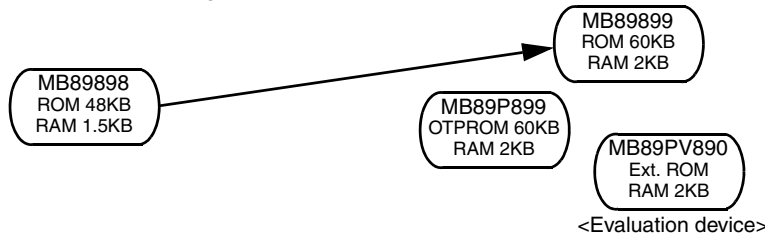

- Maximum clock frequency: 8 MHz (32.768 kHz)
- Minimum execution time: 0.5 μs to 8.0 μs (61 μs)
- Operating temperature range: -20°C to +85°C

Part number	Operating power supply voltage *(V)	Package		Functions
		QFP	MQFP	
MB89898	+2.2 to +6.0	100P	-	I/O ports: 85 Timebase timer (WDT): 21-bit × 1ch. Timer/counter: 8-bit × 2ch. (can also operate as 16-bit × 1ch.) PWM timer: 8-bit × 1ch. A/D converter: 8-bit × 8ch. DTMF generator: All tone output for CCITT SIO: 8-bit × 1ch + serial with 1-byte buffer × 1ch. MSK software modem output: 1200, 2400bps MSK software modem timer: 1ch. (built-in noise reduction circuit) Clock prescaler: 15-bit Buzzer output (7 tones) Interrupts: 9 internal, 16 external (4 × edge interrupts, 12 × level interrupts) Low-power consumption (stand-by functions) modes: Sleep, watch, stop
MB89899		100P	-	
MB89P899	+2.7 to +6.0	100P	-	
MB89PV890		-	100C	

*: A/D = 3.5V to 6.0V

Packages: P - plastic, C - ceramic

F²MC-8L Family Inverter Motor Control Products

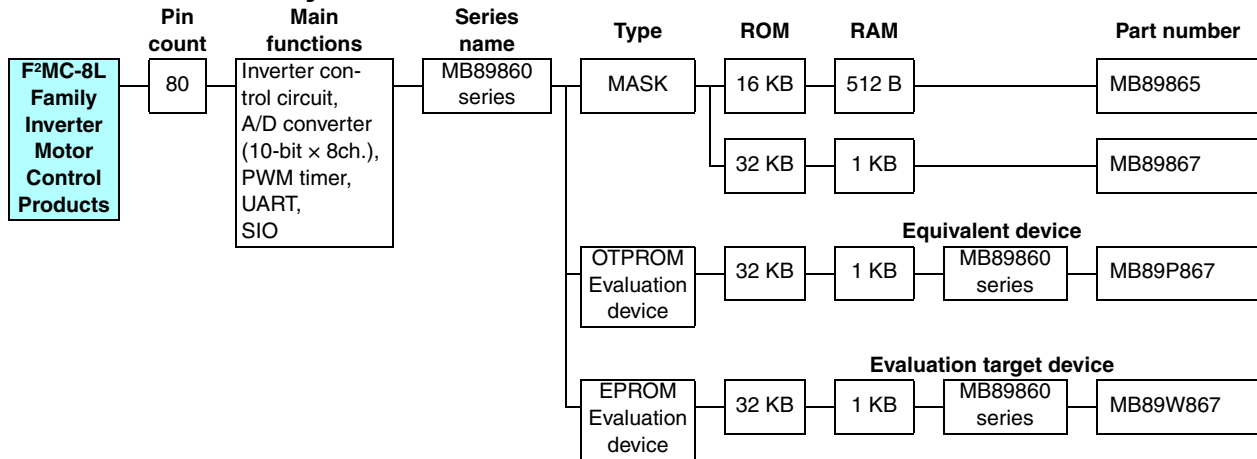

■ MB89860 Series

ASMC (1) (inverter motor control, built-in high-speed pulse output)

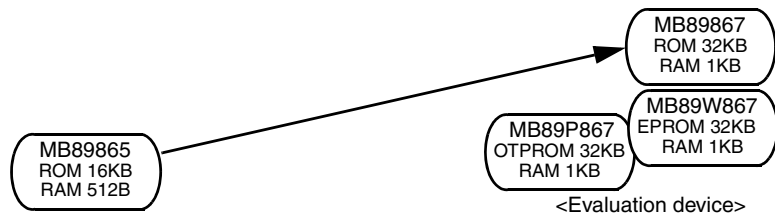

- Maximum clock frequency: 10 MHz
- Minimum execution time: 0.4 μs
- Operating temperature range: -40°C to +85°C

Part number	Operating power supply voltage (V)	Package	Functions
		QFP	
MB89865	+2.7 to +6.0 *1	80P	I/O ports:68 Timebase timer (WDT): 20-bit × 1ch. PWM timer: 8-bit × 2ch. (with reload timer function) Timer unit:10-bit up/down count timer × 1ch., output compare registers × 4 (with buffer), (0.4μs min. resolution), real time waveform output pins × 7ch. Dead time timer:4-bit load timers × 3ch. (non-overlap 3-phase waveform output for AC inverter motor control.), includes a function to disable output on detection of over-current (edge or level input) A/D converter: 10-bit × 8ch. SIO: 8-bit × 1ch. UART: 8-bit × 1ch. Interrupts: 9 internal, 4 external Low-power consumption (stand-by functions) modes: Sleep, stop
MB89867		80P	
MB89P867	+2.7 to +5.5 *2	80P	
MB89W867		80C	

*1: A/D = 3.5 V to 6.0 V

*2: A/D = 3.5 V to 5.5 V

Package: P - plastic, C - ceramic

F²MC-8L Family Internal USB Products

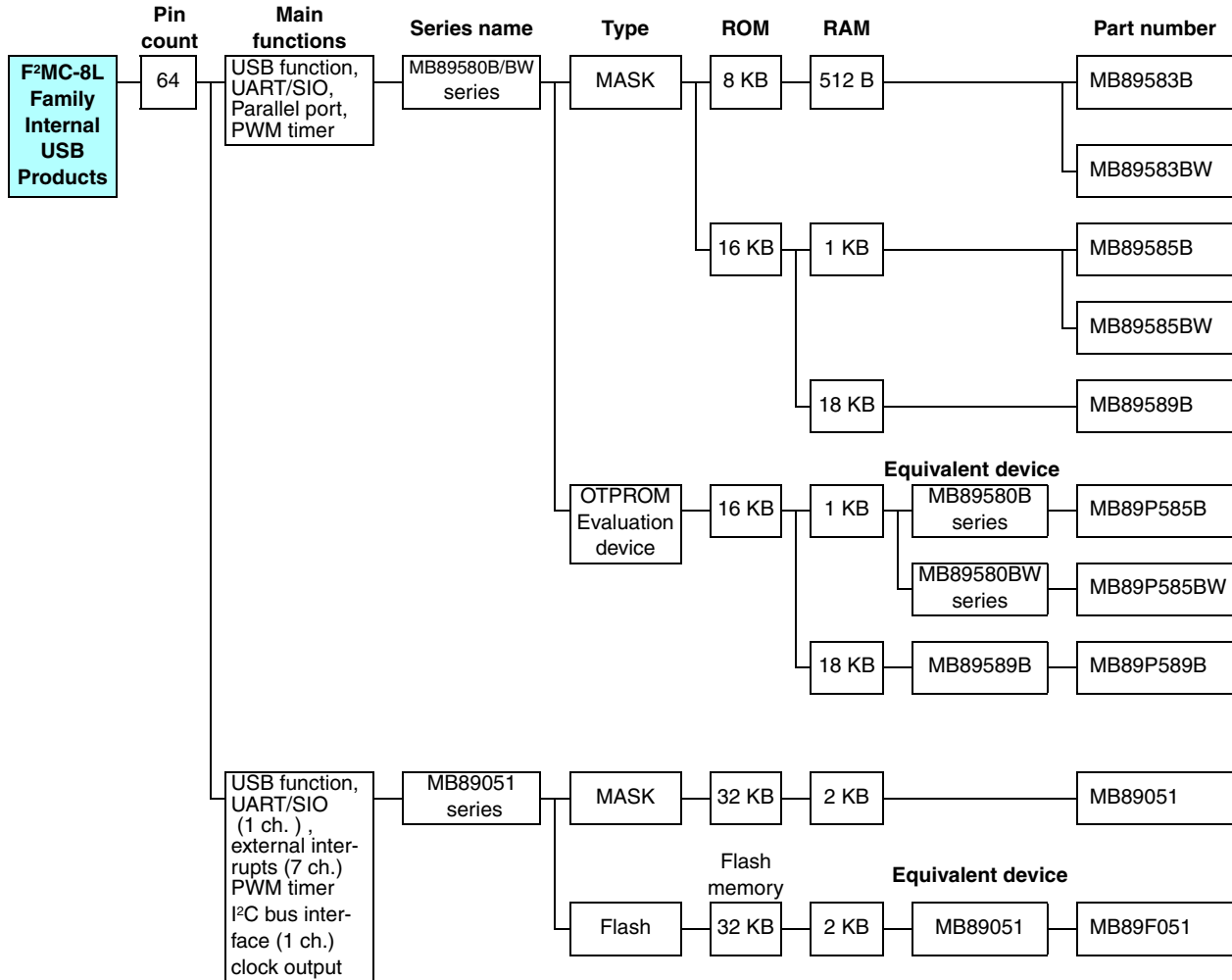

8-bit Proprietary F²MC-8L Family Internal USB Products

■ MB89580B/580BW Series

Standard products (Internal USB function)

- Maximum clock frequency: 12 MHz
- Minimum execution time: 0.33 μs
- Operating temperature range: -40°C to +85°C

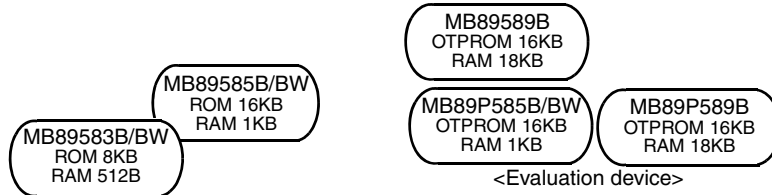

Part number	Operating power supply voltage (V)	Package		Functions
		LQFP (0.5 mm pitch)	LQFP (0.65 mm pitch)	
MB89583B	+3.0 to +5.5	64P	-	I/O ports: 53 Timebase timer: 21-bit × 1ch. PWM timer: 8-bit × 2ch. (also used as PPG timer × 1ch.) USB function UART/SIO: 1ch. Parallel port State of terminal RPVP(D+) and RPVM(D-) until starting USB connection: High-Z: MB89593B/595B/P595B Low-level output: MB89593BW/595BW/P595BW Interrupts: 8 external Low-power consumption (stand-by functions) modes: Sleep, stop
MB89583BW		64P	-	
MB89585B		64P	-	
MB89585BW		64P	-	
MB89589B		-	64P	
MB89P585B		64P	-	
MB89P585BW		64P	-	
MB89P589B		-	64P	

Package: P - plastic

■ MB89051 Series

Standard products (Internal USB function)

- Maximum clock frequency: 12 MHz
- Minimum execution time: 0.33 μs
- Operating temperature range: -40°C to +85°C (USB operation: 0°C to +70°C)



Part number	Operating power supply voltage (V)	Package	Functions
		LQFP	
MB89051	+3.0 to +5.5	64P	I/O ports: 41 USB function (endpoint: 4) Timebase timer: 21-bit × 1 ch. PWM timer: 8-bit × 2 ch. UART/SIO: 1 ch. Interrupts: 7 external I ² C bus interface (1 ch.) Clock output: 6 MHz, 12 MHz Low-power consumption (stand-by functions) modes: Sleep, stop
MB89F051		64P	

Package: P - plastic

8-bit Proprietary F²MC-8FX Family Features

F²MC-8FX Family Features

- Minimum execution time: 62.5 ns/16 MHz
- Operating voltage: +1.8 V to +3.6 V or +2.5 V to +5.5 V, external clock: 32.768 kHz to 32.5 MHz
- Software-switchable instruction cycle provides low voltage, low-power consumption operation (clock gear function)
- Backup voltage in stop mode (voltage required to maintain RAM data): Min. +1.5 V (3 V products)
- Bitwise selectable pull-up resistors for each I/O port
- Memory space: Max. 64 Kbytes

Memory space

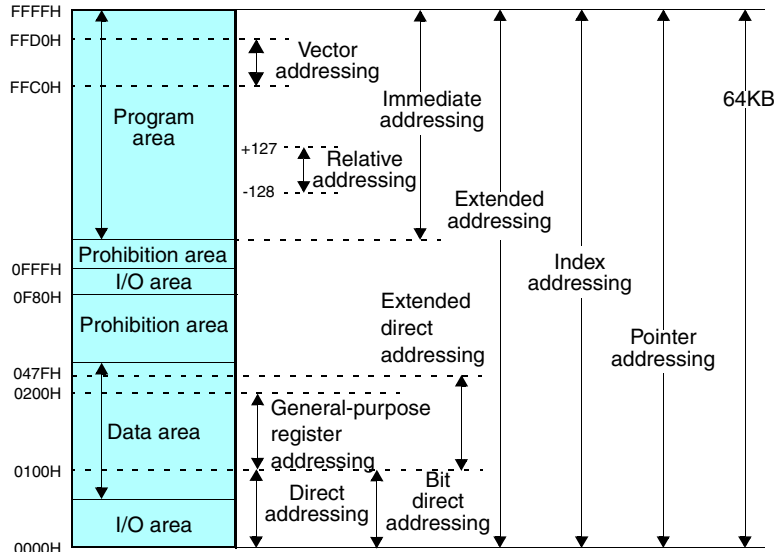

- Memory mapped I/O
 - Registers
- Dedicated registers
 General-purpose registers: 8 × 8-bit per bank, Max. 32 banks

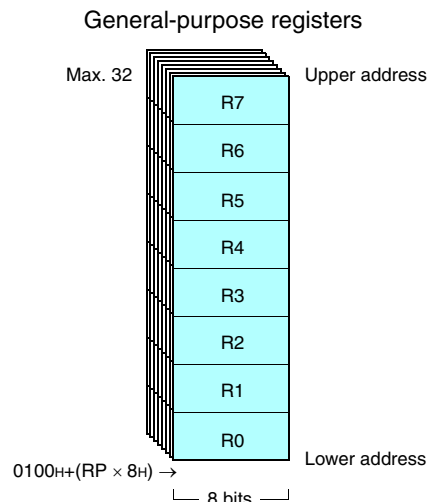
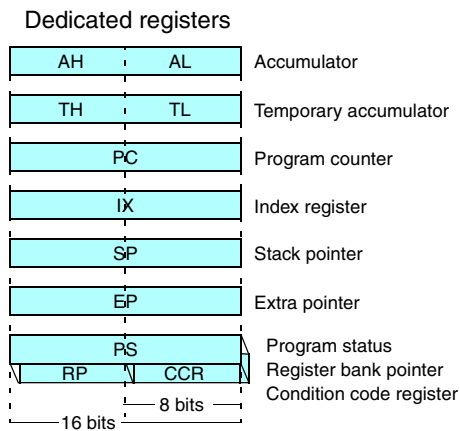

- Enhanced interrupt function (prioritized multiple interrupts)
 - Powerful operation and transfer functions
- Multiplication and division instructions: 8-bit × 8-bit = 16-bit (0.5 μs/16 MHz), 16-bit ÷ 16-bit = 16-bit (1.1 μs/16 MHz)
 Data transfer: Max. 16-bit
- Number of instructions: 136

8-bit Proprietary F²MC-8FX Family Product Range

F²MC-8FX Family Product Range

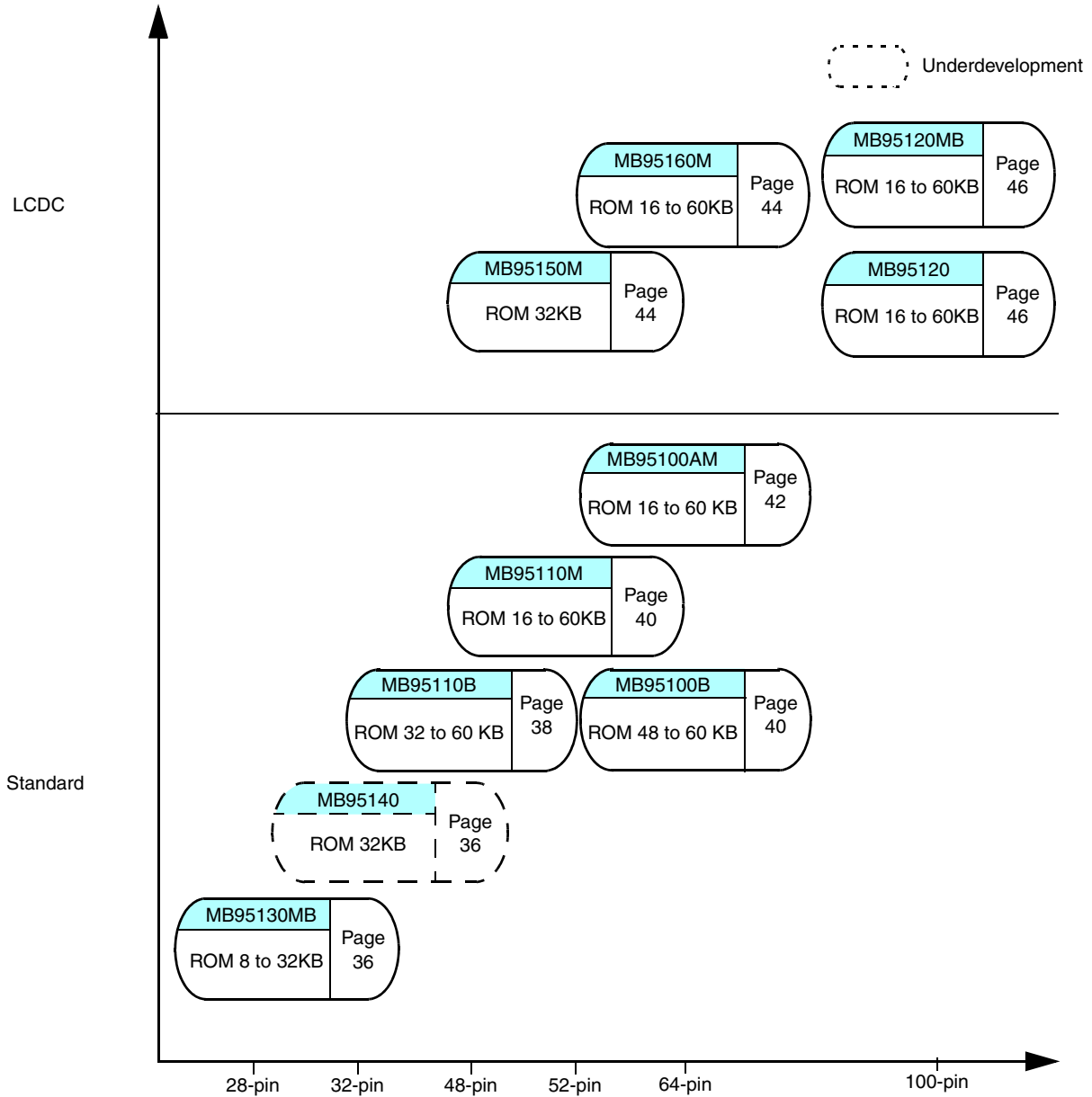

■ F²MC-8FX Family Standard Products

	Pin count	Main functions	Series name	Type	ROM	RAM	Part number			
F ² MC-8FX Family Standard Products	28/ 30	UART/SIO (1 ch.) , LIN UART (1 ch.) , 8/16-bit compound timer (1 ch.) , 8/16-bit PPG (1 ch.) , 16-bit PPG (1 ch.) , A/D converter (10-bit × 8 ch.) , external interrupts (8 ch.) , watch prescaler, watch counter	MB95130MB series	MASK	32 KB	1 KB	MB95136MB **			
				One sector Flash	8 KB	256 B	MB95F133J			
					16 KB	512 B	MB95F134J			
					32 KB	1 KB	MB95F136MB			
				Evaluation device	60 KB	3.75 KB	MB95FV100D-103			
				32	UART/SIO (1 ch.) , LIN UART (1 ch.) , 8/16-bit compound timer (2 ch.) , 8/16-bit PPG (2 ch.) , 16-bit PPG (1 ch.) , A/D converter (10-bit × 8 ch.) , external interrupts (8 ch.) , watch prescaler, watch counter	MB95140 series	One sector Flash	32 KB	1 KB	MB95F146 *
							Evaluation device	60 KB	3.75 KB	MB95FV100D-101

** : Under planning

* : Under development

(Continued)

8-bit Proprietary F²MC-8FX Family Standard Products

■ MB95130MB Series

Built-in A/D converter, UART, etc.

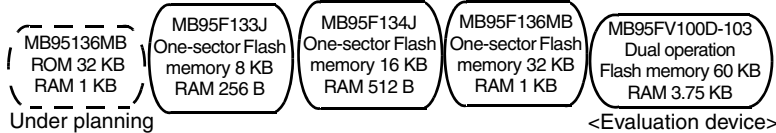

- Maximum internal clock frequency : 16 MHz (32.768 kHz × 4)
- Minimum execution time: 62.5 ns (7.63 μs)
- Operating temperature range: -40 °C to +85 °C

Part number	Operating power supply voltage (V)	Package			Functions
		SOP (1.27 mm pitch)	SSOP (0.65 mm pitch)	FBGA	
MB95F136MB	+2.5 to +5.5 *1	28P	30P	–	I/O ports: 20 Max. (single-clock) 18 Max. (dual-clock) UART/SIO : 1 ch. LIN UART : 1 ch. 8/16-bit compound timer : 16-bit × 1 ch. (8-bit × 2 ch.) 8/16-bit PPG timer : 16-bit × 1 ch. (8-bit × 2 ch.) 16-bit PPG timer : 1 ch A/D converter : 10-bit × 8 ch. Timebase timer (WDT) : 21-bit × 1 ch. External interrupt : 8 ch.
MB95F133J		28P	–	–	
MB95F134J		28P	–	–	
○ MB95136MB		28P	30P	–	
MB95FV100D-103	+2.7 to +5.5	–	–	224P	Watch prescaler, watch counter Low-voltage detection reset (option) *2 Clock Supervisor (option) *2 Low-power consumption modes : Sleep, stop, sub, watch mode

Package: P - plastic

○: Under planning

*1: The range of the voltage is different depending on the frequency.

*2: MB95F134J and MB95F133J have Low-voltage detection reset and Clock Supervisor.

■ MB95140 Series

Built-in A/D converter, UART, etc.

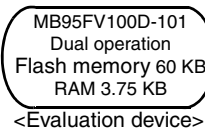
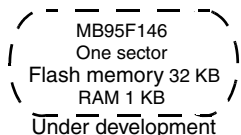

- Maximum internal clock frequency : 16 MHz (32.768 kHz × 4)
- Minimum execution time: 62.5 ns (7.63 μs)
- Operating temperature range: -40 °C to +85 °C *

Part number	Operating power supply voltage (V)	Package		Functions
		LQFP (0.8 mm pitch)	FBGA	
◎ MB95F146	+1.8 to +3.3 *	32P	–	I/O ports: 24 Max. (single-clock) 22 Max. (dual-clock) UART/SIO : 1 ch. LIN UART : 1 ch. 8/16-bit compound timer : 16-bit × 2 ch. (8-bit × 4 ch.) 8/16-bit PPG timer : 16-bit × 2 ch. (8-bit × 4 ch.) 16-bit PPG timer : 1 ch A/D converter : 10-bit × 8 ch. Timebase timer (WDT) : 21-bit × 1 ch. External interrupt : 8 ch. Watch prescaler, watch counter Low-power consumption modes : Sleep, stop, sub, watch mode
MB95FV100D-101	+2.6 to +3.6	–	224P	

Package: P - plastic

◎: Under development

*: The range of the voltage is different depending on the temperature and the frequency.

8-bit Proprietary F²MC-8FX Family Standard Products

(Continued)

Pin count	Main functions	Series name	Type	ROM	RAM	Part number
48 52	UART/SIO (1 ch.) , LIN UART (1 ch.) , I ² C bus interface (1 ch.) , 8/16-bit compound timer (2 ch.) , 8/16-bit PPG (2 ch.) , 16-bit PPG (1 ch.) , A/D converter (10-bit × 8 ch.) , external interrupts (8 ch.) , watch prescaler, watch counter	MB95110B series	Mask	32 KB	1 KB	MB95116B
			Dual operation Flash	60 KB	2 KB	MB95F118B
			Evaluation device	60 KB	3.75 KB	MB95FV100D-101

(Continued)

8-bit Proprietary F²MC-8FX Family Standard Products

■ MB95110B Series

Built-in A/D converter, UART, etc.

MB95116B
ROM 32 KB
RAM 1 KB

MB95F118B
Dual operation
Flash memory 60 KB
RAM 2 KB

MB95FV100D-101
Dual operation
Flash memory 60 KB
RAM 3.75 KB
<Evaluation device>

- Maximum internal clock frequency : 16 MHz (32.768 kHz × 4)
- Minimum execution time: 62.5 ns (7.63 μs)
- Operating temperature range: -40 °C to +85 °C *

Part number	Operating power supply voltage (V)	Package				Functions
		LQFP (0.5 mm pitch)	BCC (0.5 mm pitch)	LQFP (0.65 mm pitch)	FBGA	
MB95116B	+1.8 to +3.6 *1	48P	48P	*2	–	I/O ports: 40 Max. (single-clock) 38 Max. (dual-clock) UART/SIO : 1 ch. LIN UART : 1 ch. I ² C bus interface : 1 ch.
MB95F118B	+1.8 to +3.3 *1	48P	48P	52P	–	8/16-bit compound timer : 16-bit × 2 ch. (8-bit × 4 ch.) 8/16-bit PPG timer : 16-bit × 2 ch. (8-bit × 4 ch.) 16-bit PPG timer : 1 ch A/D converter : 10-bit × 8 ch.
MB95FV100D-101	+2.6 to +3.6	–	–	–	224P	Timebase timer (WDT) : 21-bit × 1 ch. External interrupt : 8 ch. Watch prescaler, watch counter Low-power consumption modes : Sleep, stop, sub, watch mode

Package: P - plastic

*1: The range of the voltage is different depending on the temperature and the frequency.

*2: Under development

8-bit Proprietary F²MC-8FX Family

Standard Products

(Continued)

Pin count	Main functions	Series name	Type	ROM	RAM	Part number
52	UART/SIO (1 ch.) , LIN UART (1 ch.) , I ² C bus interface (1 ch.) , 8/16-bit compound timer (2 ch.) , 8/16-bit PPG (2 ch.) , 16-bit PPG (1 ch.) , A/D converter (10-bit × 8 ch.) , external interrupts (8 ch.) , watch prescaler, watch counter	MB95110M series	Mask	48 KB	2 KB	MB95117M
			Dual operation Flash	60 KB	2 KB	MB95F118M
			Flash	16 KB	512 B	MB95F114J *
				32 KB	1 KB	MB95F116J *
			Evaluation device	60 KB	3.75 KB	MB95FV100D-103
*: Under development						
64	UART/SIO (1 ch.) , LIN UART (1 ch.) , I ² C bus interface (1 ch.) , 8/16-bit compound timer (2 ch.) , 8/16-bit PPG (2 ch.) , 16-bit PPG (2 ch.) , 16-bit reload timer (1 ch.) , A/D converter (10-bit × 12 ch.) , external interrupts (12 ch.) , watch prescaler, watch counter	MB95100B series	Mask	48 KB	2 KB	MB95107B
			Dual operation Flash	60 KB	2 KB	MB95F108B
			Evaluation device	60 KB	3.75 KB	MB95FV100D-101

(Continued)

8-bit Proprietary F²MC-8FX Family Standard Products

■ MB95110M Series

Built-in A/D converter, UART, etc.

MB95117M ROM 48 KB RAM 2 KB	MB95F114J Flash memory 16 KB RAM 512 B Under development	MB95F116J Flash memory 32 KB RAM 1 KB Under development	MB95F118M Dual operation Flash memory 60 KB RAM 2 KB	MB95FV100D-103 Dual operation Flash memory 60 KB RAM 3.75 KB <Evaluation device>	<ul style="list-style-type: none"> • Maximum internal clock frequency : 16 MHz (32.768 kHz × 4) • Minimum execution time: 62.5 ns (7.63 μs) • Operating temperature range: -40 °C to +85 °C
-----------------------------------	---	--	---	--	--

Part number	Operating power supply voltage (V)	Package		Functions
		LQFP (0.65 mm pitch)	FBGA	
MB95117M	+2.5 to +5.5 *1	52P	–	I/O ports: 40 Max. (single-clock) 38 Max. (dual-clock) UART/SIO : 1 ch. LIN UART : 1 ch. I ² C bus interface : 1 ch. 8/16-bit compound timer : 16-bit × 2 ch. (8-bit × 4 ch.) 8/16-bit PPG timer : 16-bit × 2 ch. (8-bit × 4 ch.) 16-bit PPG timer : 1 ch. 16-bit reload timer : 1 ch. A/D converter : 10-bit × 8 ch. Timebase timer (WDT) : 21-bit × 1 ch. External interrupt : 8 ch. Watch prescaler, watch counter Low-voltage detection reset (option) *2 Clock supervisor (option) *2 Low-power consumption modes : Sleep, stop, sub, watch mode
⊙ MB95F114J		52P	–	
⊙ MB95F116J		52P	–	
MB95F118M		52P	–	
MB95FV100D-103	+2.7 to +5.5	–	224P	

Package: P - plastic

⊙: Under development

*1: The range of the voltage is different depending on the frequency.

*2: MB95F114J and MB95F116J have Low-voltage detection reset and Clock supervisor.

■ MB95100B Series

Built-in A/D converter, UART, etc.

MB95107B ROM 48 KB RAM 2 KB Under development	MB95F108B Dual operation Flash memory 60 KB RAM 2 KB Under development	MB95FV100D-101 Dual operation Flash memory 60 KB RAM 3.75 KB <Evaluation device>	<ul style="list-style-type: none"> • Maximum internal clock frequency : 16 MHz (32.768 kHz × 4) • Minimum execution time: 62.5 ns (7.63 μs) • Operating temperature range: -40 °C to +85 °C *
--	--	--	--

Part number	Operating power supply voltage (V)	Package			Functions
		LQFP (0.5 mm pitch)	BCC (0.5 mm pitch)	FBGA	
MB95107B	+1.8 to +3.6 *	64P	64P	–	I/O ports: 55 Max. (single-clock) 53 Max. (dual-clock) UART/SIO : 1 ch. LIN UART : 1 ch. I ² C bus interface : 1 ch. 8/16-bit compound timer : 16-bit × 2 ch. (8-bit × 4 ch.) 8/16-bit PPG timer : 16-bit × 2 ch. (8-bit × 4 ch.) 16-bit PPG timer : 2 ch. A/D converter : 10-bit × 12 ch. Timebase timer (WDT) : 21-bit × 1 ch. External interrupt : 12 ch. Watch prescaler, watch counter Low-power consumption modes : Sleep, stop, sub, watch mode
MB95F108B	+1.8 to +3.3 *	64P	64P	–	
MB95FV100D-101	+2.6 to +3.6	–	–	224P	

Package: P - plastic

*: The range of the voltage is different depending on the temperature and the frequency.

8-bit Proprietary F²MC-8FX Family Standard Products

(Continued)

Main functions	Series name	Type	ROM	RAM	Part number
UART/SIO (1 ch.) , LIN UART (1 ch.) , I ² C bus interface (1 ch.) , 8/16-bit compound timer (2 ch.) , 8/16-bit PPG (2 ch.) , 16-bit PPG (2 ch.) , 16-bit reload timer (1 ch.) , A/D converter (10-bit × 12 ch.) , External interrupts (12 ch.) , watch prescaler, watch counter	MB95100AM series	Mask	60 KB	2 KB	MB95108AM
		Dual operation Flash	60 KB	2 KB	MB95F108AM
		Flash	16 KB	512 B	MB95F104AJ
			32 KB	1 KB	MB95F106AJ
		Evaluation device	60 KB	3.75 KB	MB95FV100D-103

8-bit Proprietary F²MC-8FX Family Standard Products

■ MB95100AM Series

Built-in A/D converter, UART, etc.

MB95108AM ROM 60 KB RAM 2 KB	MB95F104AJ Flash memory 16 KB RAM 512 B	MB95F106AJ Flash memory 32 KB RAM 1 KB	MB95F108AM Dual operation Flash memory 60 KB RAM 2 KB	MB95FV100D-103 Dual operation Flash memory 60 KB RAM 3.75 KB	<ul style="list-style-type: none"> Maximum internal clock frequency : 16 MHz (32.768 kHz × 4) Minimum execution time: 62.5 ns (7.63 μs) Operating temperature range: -40 °C to +85 °C
<Evaluation device>					

Part number	Operating power supply voltage (V)	Package			Functions
		LQFP (0.5 mm pitch)	LQFP (0.65 mm pitch)	FBGA	
MB95108AM	+2.5 to +5.5 *1	64P	64P	–	I/O ports: 54 Max. (single-clock) 52 Max. (dual-clock) UART/SIO : 1 ch. LIN UART : 1 ch. I ² C bus interface : 1 ch. 8/16-bit compound timer : 16-bit × 2 ch. (8-bit × 4 ch.) 8/16-bit PPG timer : 16-bit × 2 ch. (8-bit × 4 ch.) 16-bit PPG timer : 2 ch. 16-bit reload timer : 1 ch. A/D converter : 10-bit × 12 ch. Timebase timer (WDT) : 21-bit × 1 ch. External interrupts : 12 ch. Watch prescaler, watch counter Low-voltage detection reset (option) *2 Clock supervisor (option) *2 Low-power consumption modes : Sleep, stop, sub, watch mode
MB95F104AJ		64P	64P	–	
MB95F106AJ		64P	64P	–	
MB95F108AM		64P	64P	–	
MB95FV100D-103	+2.7 to +5.5	–	–	224P	

Package: P - plastic

*1: The range of the voltage is different depending on the frequency.

*2: MB95F104AJ and MB95F106AJ have Low-voltage detection reset and Clock supervisor.

■ F²MC-8FX Family Internal LCDC Products

	Pin count	Main functions	Series name	Type	ROM	RAM	Part number
F²MC-8FX Family Internal LCDC Products	48 52	UART/SIO (1 ch.) , LIN UART (1 ch.) , 8/16-bit compound timer (2 ch.) , 8/16-bit PPG (2 ch.) , 16-bit PPG (1 ch.) , A/D converter (10-bit × 8 ch.) , external interrupts (8 ch.) , LCD controller, watch prescaler, watch counter	MB95150M series	Mask	32 KB	1 KB	MB95156M
				One sector Flash	32 KB	1 KB	MB95F156M
				Evaluation device	60 KB	3.75 KB	MB95FV100D-103
	64	UART/SIO (1 ch.) , LIN UART (1 ch.) , I ² C bus interface (1 ch.) , 8/16-bit compound timer (2 ch.) , 8/16-bit PPG (2 ch.) , 16-bit PPG (1 ch.) , 16-bit reload timer (1 ch.) , A/D converter (10-bit × 8 ch.) , external interrupts (8 ch.) , LCD controller, watch prescaler, watch counter	MB95160 series	One sector Flash	60 KB	2 KB	MB95F168M
				Evaluation device	60 KB	3.75 KB	MB95FV100D-103

(Continued)

8-bit Proprietary F²MC-8FX Family Internal LCDC Products

■ MB95150M Series

Built-in A/D converter, UART, LCD controller, etc.

MB95156M ROM 32 KB RAM 1 KB	MB95F156M One sector Flash memory 32 KB RAM 1 KB	MB95FV100D-103 Dual operation Flash memory 60 KB RAM 3.75 KB
-----------------------------------	---	---

<Evaluation device>

- Maximum internal clock frequency : 16 MHz (32.768 kHz × 4)
- Minimum execution time: 62.5 ns (7.63 μs)
- Operating temperature range: -40 °C to +85 °C

Part number	Operating power supply voltage (V)	Package			Functions
		LQFP (0.5 mm pitch)	LQFP (0.65 mm pitch)	FBGA	
MB95156M	+2.5 to +5.5 *	48P	52P	–	I/O ports: 39 Max. (dual-clock) UART/SIO : 1 ch. LIN UART : 1 ch. 8/16-bit compound timer : 16-bit × 2 ch. (8-bit × 4 ch.) 8/16-bit PPG timer : 16-bit × 2 ch. (8-bit × 4 ch.) 16-bit PPG timer : 1 ch. A/D converter : 10-bit × 8 ch. Timebase timer (WDT) : 21-bit × 1 ch. External interrupts : 8 ch. LCD controller: 16 elements, 16 seg × 4 com 16 × 4-bit LCD display RAM
MB95F156M		48P	52P	–	
MB95FV100D-103	+2.7 to +5.5	–	–	224P	Watch prescaler, watch counter Low-voltage detection reset (option) Clock supervisor (option) Low-power consumption modes : Sleep, stop, sub, watch mode

Package: P - plastic

*: The range of the voltage is different depending on the frequency.

■ MB95160M Series

Built-in A/D converter, UART, LCD controller, etc.

MB95F168M One sector Flash memory 60 KB RAM 2 KB	MB95FV100D-103 One-sector Flash memory 60 KB RAM 3.75 KB
---	---

<Evaluation device>

- Maximum internal clock frequency : 16 MHz (32.768 kHz × 4)
- Minimum execution time: 62.5 ns (7.63 μs)
- Operating temperature range:
 - 40 °C to +85 °C (No low-voltage detection reset)
 - 40 °C to +85 °C (Low-voltage detection reset)

Part number	Operating power supply voltage (V)	Package			Functions
		LQFP (0.5 mm pitch)	QFP (0.65 mm pitch)	FBGA	
MB95F168M	+2.5 to +5.5 *	64P	64P	–	I/O ports: 53 Max. (dual-clock) UART/SIO : 1 ch. LIN UART : 1 ch. I ² C bus interface : 1 ch. 8/16-bit compound timer : 16-bit × 2 ch. (8-bit × 4 ch.) 8/16-bit PPG timer : 16-bit × 2 ch. (8-bit × 4 ch.) 16-bit PPG timer : 1 ch. A/D converter : 10-bit × 8 ch. Timebase timer (WDT) : 21-bit × 1 ch. External interrupts : 8 ch. LCD controller: 128 elements, 32 seg × 4 com 32 × 4-bit LCD display RAM
MB95FV100D-103		–	–	224P	

Package: P - plastic

*: The range of the voltage is different depending on the frequency.

8-bit Proprietary F²MC-8FX Family Internal LCDC Products

(Continued)

Pin count	Main functions	Series name	Type	ROM	RAM	Part number	
100	UART/SIO (1 ch.) , LIN UART (1 ch.) , I ² C bus interface (1 ch.) , 8/16-bit compound timer (2 ch.) , 8/16-bit PPG (2 ch.) , 16-bit PPG (2 ch.) , 16-bit reload timer (1 ch.) , A/D converter (10-bit × 12 ch.) , external interrupts (12 ch.) , LCD controller, watch prescaler, watch counter	MB95120MB series	Dual operation Flash	60 KB	2 KB	MB95F128MB	
			Flash	16 KB	512 B	MB95F124MB	
				32 KB	1 KB	MB95F126MB	
			Mask	60 KB	2 KB	MB95128MB	
			Evaluation device	60 KB	3.75 KB	MB95FV100D-103	
		MB95120 series	UART/SIO (1 ch.) , LIN UART (1 ch.) , I ² C bus interface (1 ch.) , 8/16-bit compound timer (2 ch.) , 8/16-bit PPG (2 ch.) , 16-bit PPG (2 ch.) , 16-bit reload timer (1 ch.) , A/D converter (10-bit × 12 ch.) , External interrupts (12 ch.) , LCD controller, watch prescaler, watch counter	Dual operation Flash	60 KB	2 KB	MB95F128D
				Evaluation device	60 KB	3.75 KB	MB95FV100D-101

8-bit Proprietary F²MC-8FX Family Internal LCDC Products

■ MB95120MB Series

Built-in A/D converter, UART, LCD controller, etc.



<Evaluation device>

- Maximum internal clock frequency : 16 MHz (32.768 kHz × 4)
- Minimum execution time: 62.5 ns (7.63 μs)
- Operating temperature range: -40 °C to +85 °C

Part number	Operating power supply voltage (V)	Package			Functions
		LQFP (0.5 mm pitch)	QFP (0.65 mm pitch)	FBGA	
MB95F124MB	+2.5 to +5.5 *1	100P	100P	-	I/O ports: 87 Max. (single-clock) 85 Max. (dual-clock) UART/SIO : 1 ch. LIN UART : 1 ch. I ² C bus interface : 1 ch. 8/16-bit compound timer : 16-bit × 2 ch. (8-bit × 4 ch.) 8/16-bit PPG timer : 16-bit × 2 ch. (8-bit × 4 ch.) 16-bit PPG timer : 2 ch. 16-bit reload timer : 1 ch. A/D converter : 10-bit × 12 ch. Timebase timer (WDT) : 21-bit × 1 ch. External interrupts : 12 ch. LCD controller: 160 elements, 40 seg × 4 com 40 × 4-bit LCD display RAM
MB95F126MB		100P	100P	-	
MB95F128MB		100P	100P	-	
MB95128MB		100P	100P	-	
MB95FV100D-103	+2.7 to +5.5	-	-	224P	Watch prescaler, watch counter Low-voltage detection reset (option) *2 Clock supervisor (option) *2 Low-power consumption modes : Sleep, stop, sub, watch mode

Package: P - plastic

*1: The range of the voltage is different depending on the frequency.

*2: MB95F124JB and MB95F126JB have Low-voltage detection reset and Clock supervisor.

■ MB95120 Series

Built-in A/D converter, UART, LCD controller, etc.



<Evaluation device>

- Maximum internal clock frequency : 16 MHz (32.768 kHz × 4)
- Minimum execution time: 62.5 ns (7.63 μs)
- Operating temperature range: -40 °C to +85 °C

Part number	Operating power supply voltage (V)	Package			Functions
		LQFP (0.5 mm pitch)	LQFP (0.65 mm pitch)	FBGA	
MB95F128D	+1.8 to +3.6 *	100P	100P	-	I/O ports: 86 Max. UART/SIO : 1 ch. LIN UART : 1 ch. I ² C bus interface : 1 ch. 8/16-bit compound timer : 16-bit × 2 ch. (8-bit × 4 ch.) 8/16-bit PPG timer : 16-bit × 2 ch. (8-bit × 4 ch.) 16-bit PPG timer : 2 ch. 16-bit reload timer : 1 ch. A/D converter : 10-bit × 12 ch. Timebase timer (WDT) : 21-bit × 1 ch. External interrupts : 12 ch. LCD controller: 160 elements, 40 seg × 4 com 40 × 4-bit LCD display RAM Watch prescaler, watch counter Low-power consumption modes : Sleep, stop, sub, watch mode
MB95FV100D-101	+2.6 to +3.6	-	-	224P	

Package: P - plastic

*: The range of the voltage is different depending on the frequency.

■ F²MC-8L/8FX Family Support Tools

Environment Development Features

(1) Development efficiency enhancement

- Provides integrated total environment
SOFTUNE V3 Workbench (Manager + Debugger)
SOFTUNE V3 Workbench (Manager + Debugger) integrates language tools and debugger tools, further facilitating the repeated process of coding, compiling and debugging.
- High programming efficiency
C compiler support
Structured assembly language support
- High programming development efficiency
Provides C library
Supports C language and assembly source debugging function
- Easy operation by multi windows
SOFTUNE V3 Workbench (manager + debugger)
SOFTUNE V3 C checker
SOFTUNE V3 C analyzer

(2) Efficient system development tools

- Provides realtime debugging using real target board
Evaluation tool + SOFTUNE V3 Workbench emulator debugger
- Provides software debugging without target board

(3) Total development environment

- Personal computer (IBM-PC)
- In Circuit Emulator tool (MB2140 series)

(4) Conformity with standards

Improves versatility and portability of software resources

- C language: Conforms to ANSI standard
- C library: Conforms to ANSI standard

SOFTUNE V3

1. The SOFTUNE Integrated Development Environment

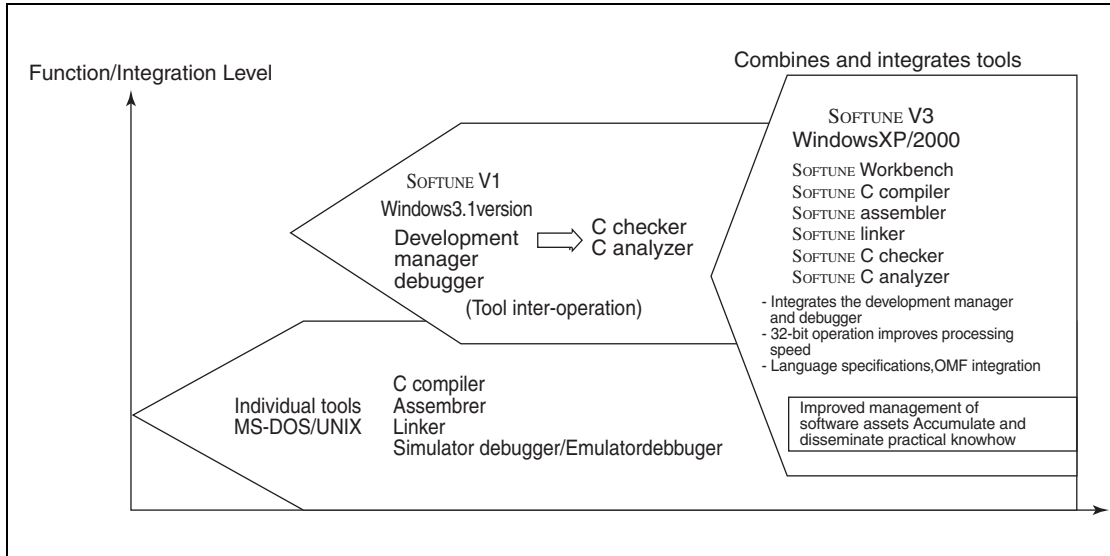

2. SOFTUNE V3 Features and Structure

Workbench integrated project manager and two debugger modules

Errors can be corrected on the “fly”, as they are discovered, and the resulting code can be debugged on the spot.

A variety of tools to support C-language coding are available

“C Checker” confirms code operation and “C Analyzer” analyzes the code’s structure.

(1) Removing the Annoying Settings which are Part of Program Development

Developing programs for different systems requires the programmer to edit source code, perform actual builds and confirm program operations (debug). Finally, the programmer returns to the editing process to incorporate necessary changes, as indicated by debugging results.

SOFTUNE V3 is an integrated developing environment which is designed to perform such repetitive processes smoothly and efficiently. It is the third generation of SOFTUNE, which has evolved to meet various needs of our customers.

(2) Program Flow

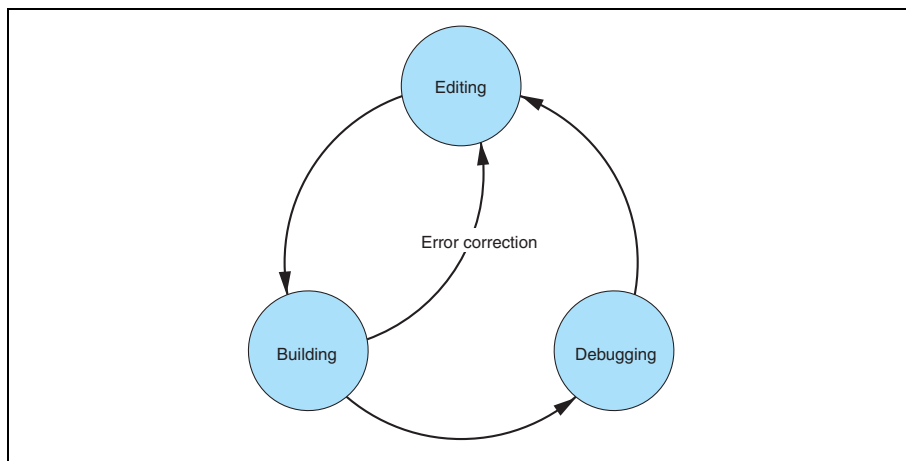

8-bit Proprietary F²MC-8L/8FX Family Support Tools

(3) Structure of SOFTUNE V3

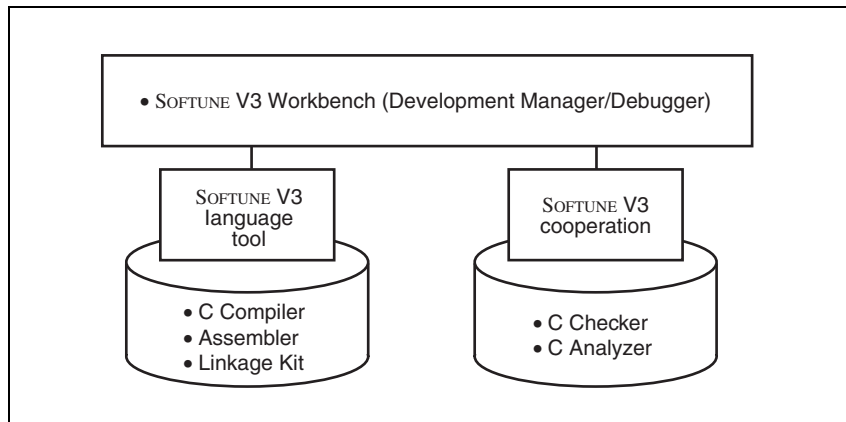

(4) Environment with SOFTUNE V3

The Efficient and Easy-to-Use Integrated Developing Environment.

Program development requires repeated editing, make/build, and debugging operations. Performing these functions smoothly and effectively contributes to improved efficiency.

The SOFTUNE V3 integrated developing system is designed to meet program developers' numerous demands, while ensuring ease of use.

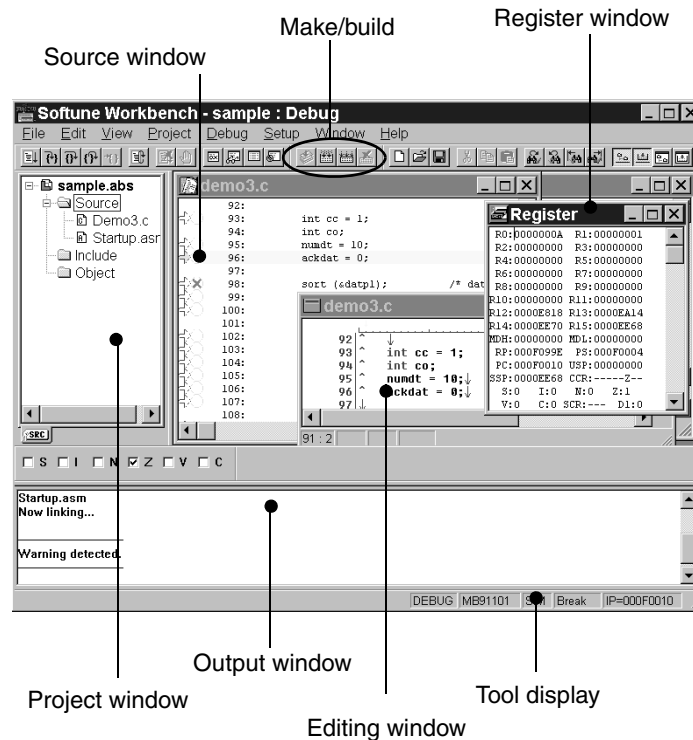

3. Manager Functions

Software programming proceeds according to the “project file”, which contains all the information needed for program development.

Work space can manage two or more projects.

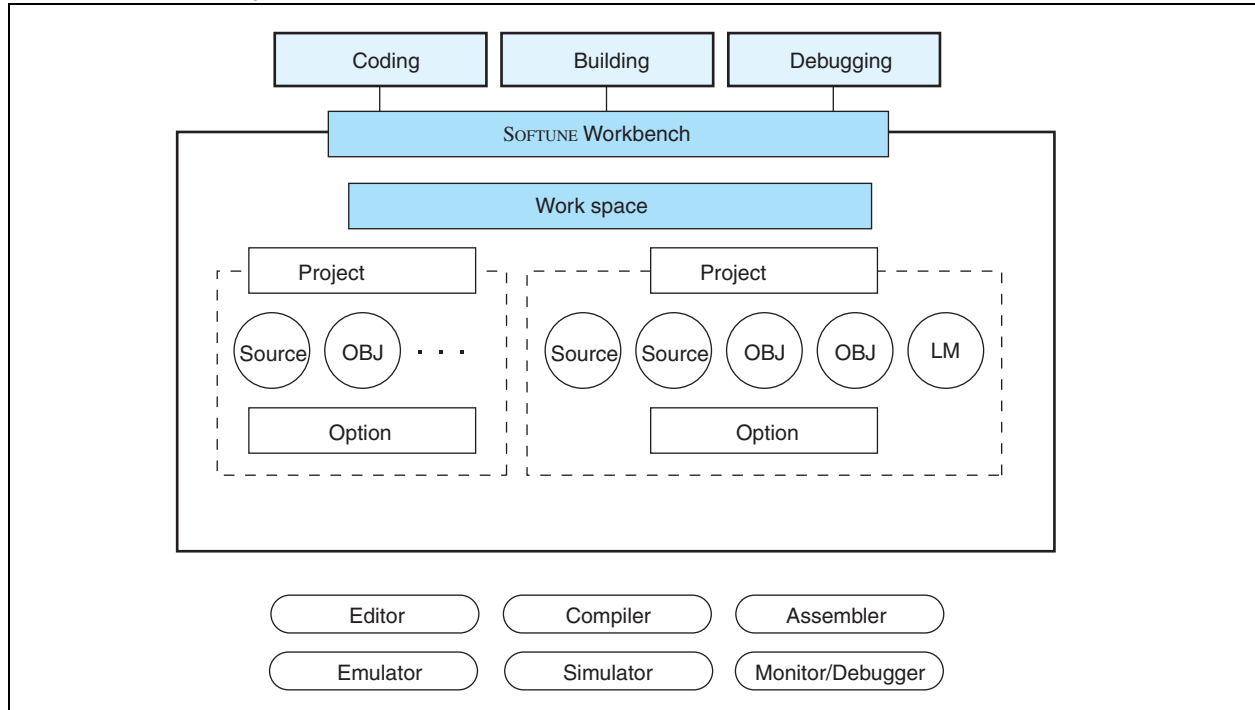

(1) Effective Project Usage

Whether working alone on several projects simultaneously or developing a project as a group, project files can be used to create a simple developing environment.

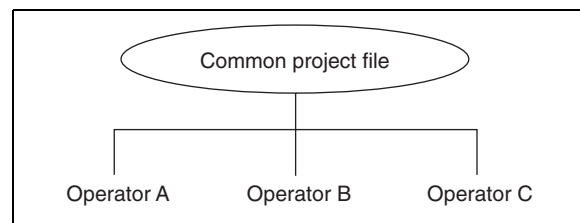

(2) Extremely Easy to Use

- **Built-in Editor**
The built-in editor comes complete with many useful functions, such as visual keyword emphasis and auto-indent.
- **Error Jump and On-line Help**
Errors that occur during builds are displayed in the output window at the bottom of the screen. To make a “Tag-jump” Double-click Mouse. Once on the error press “F1 key” for a more detailed error display.
- **Cooperation with Commercially Available Editors**
To meet developers’ requests to use editors to which they are accustomed, SOFTUNE can be configured to use the following commercially available editors: (Codewright32, TextPAD32 and others)

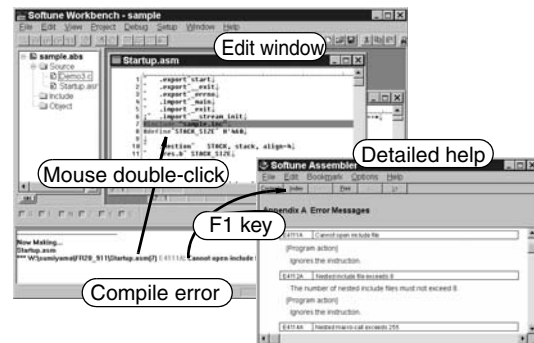

(3) Customizable Environment

When sharing files, cooperation with source generation management tools is assured, and file type conversion tools are called up, so that each person can operate in his or her own customized developing environment.

4. Debugger Function

SOFTUNE Workbench supports three debuggers that are needed at various stages of development. The appropriate debugger environment can be selected to match the situation.

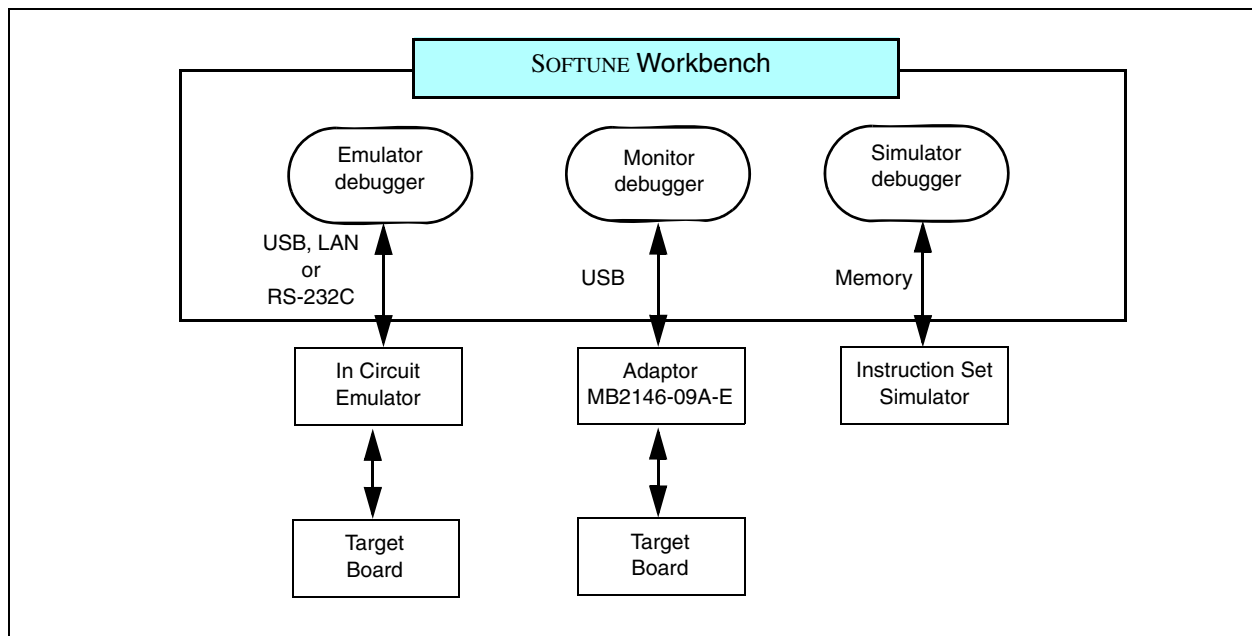

(1) Easy-to see Screen Information

The user can freely change the screen layout by selecting the necessary windows. In addition, the displayed information can be selected to provide only the information that is necessary.

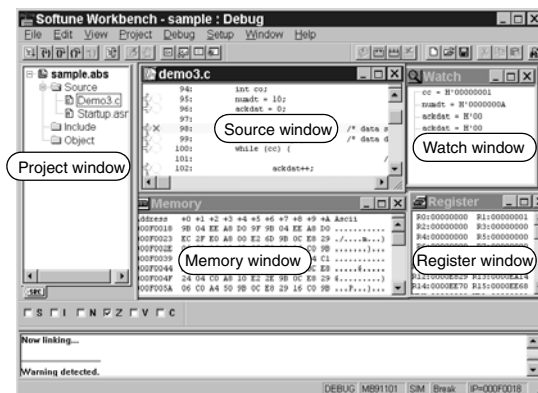

(2) Simple Environment Setting

- Debugging Environment: Setup "Wizard"
The setup "wizard" supports the selection of communication lines with emulator and boards, as well as window settings.
- MCU Operating Environment
The so-called "CPU information file," which contains the information required to support all MCUs, is provided as standard. Necessary information such as I/O port locations, ROM/RAM capacity and initial addresses can be set automatically.
- Saving and Restoring the Debugging Environment
Previous debugging environment specification, such as window locations, breakpoint settings, and memory mapping information, are saved, so that these settings are restored the next time the program is initiated.

5. Cooperation

In cooperation with SOFTUNE Workbench, the following SOFTUNE components help improve the quality of C-language programming, which greatly increases reviewing and documentation efficiency.

1)SOFTUNE V3 C Checker

Designed to meet the following requests from beginners through to advanced users:

- Eliminate all coding mistakes.
- Review programs quickly and efficiently.
- Enable even C-language beginners to create quality code.
- Maximize coding skills.
- Use software assets on Fujitsu Microelectronics CPUs.

The SOFTUNE C Checker checks code for maintainability, methods of expanding specifications and transportability; indicates areas where quality and performance could be improved, and reports these results to the user. The user can then review the C-language code.

(1) Outline

Recently software for embedded microcontrollers has been developed in the C language. However, it is difficult to understand the message output from a compiler unless the language specifications are well known.

This development support tool checks C-source programs to display and print advice for better quality and performance. It also has a facility for selecting necessary advice carefully.

(2) Features

- Outputs advised to be suitable for these objectives: Portability, coding error performance, porting to Fujitsu Microelectronics CUP's.
- Allows customization according to the programmers level.
- Works with C compilers (fcc911/fcc911s, cc907/fcc907s, fcc896s) for Fujitsu microcontrollers (FR family, F²MC-16 family, and F²MC-8L/8FX family).
- Provides easy operation and simple display over a GUI.

(3) Advising Function

The following pieces of advice are given. "Reason of check", "Example of program", "Suggestion of correction", and "One-point advice" are displayed and explained for each check item.

- Portability

This tool makes a close check on the items "processing-defined operation" and "undefined operation" which can be problems in portability within the ANSI standard.

It also gives an explanation of the operation of C compilers (Fcc911, Fcc907 and Fcc896) for Fujitsu microcontrollers.

For example, the tool gives the user proper advice on many problems (such as a data type acceptable to a structure, code, and its arrangement) at the time of porting.

- Coding error

This tool indicates the items which are not wrong in the language specifications but may cause an error and the items which are logically inconsistent.

For example, the equivalent expression "if (a==0)" in the if statement is likely to be typed as the assignment expression "if (a=0)" by mistake. Most compilers cannot detect such an error.

- Performance

This tool indicates the items generally providing better performance and the items essential and effective for the FR family, F²MC-16 family and F²MC-8L/8FX family.

Stress is especially, put on the detection of object size reduction which can be a problem in software for embedded microcontrollers.

For example, if a function return value is structure of the double type, an area is reserved for the return value and an object which is to be transferred to the area is output.

This tool advises the user to transfer the function return value by a pointer and largely reduce the object size.

- Porting to Fujitsu Microelectronics CPU

This tool advises the user what to consider in porting existing software from other makers' CPU to Fujitsu CPU in the FR family, F²MC-16 family and F²MC-8L/8FX family.

For example, in porting software resources created for the F²MC-16 family to the FR family, this tool advises the user to delete the expansion specifications (`__far`, `__near`, and `__direct` etc.) inherent to the F²MC-16 family.

8-bit Proprietary F²MC-8L/8FX Family Support Tools

- Indicated messages output

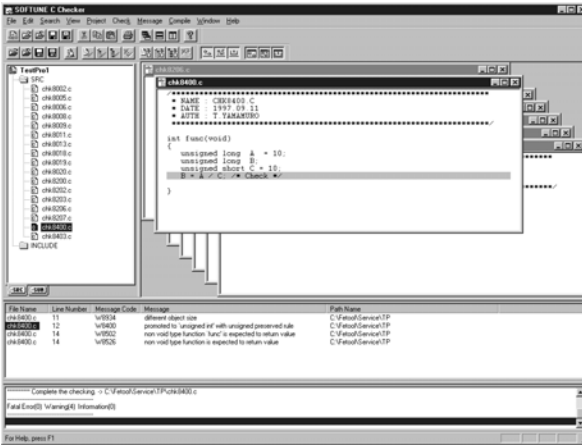

- Coding error indicated and advice displayed

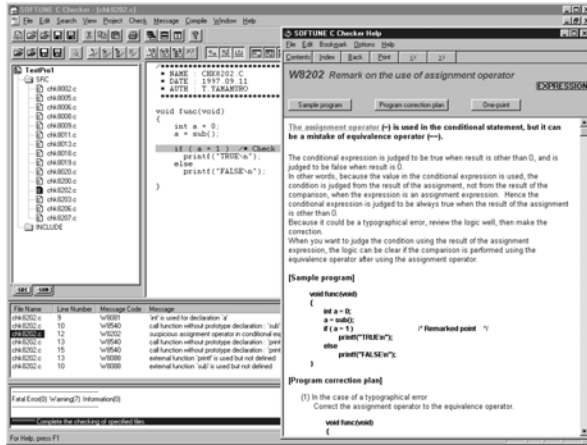

- Advice of porting to Fujitsu C compilers displayed

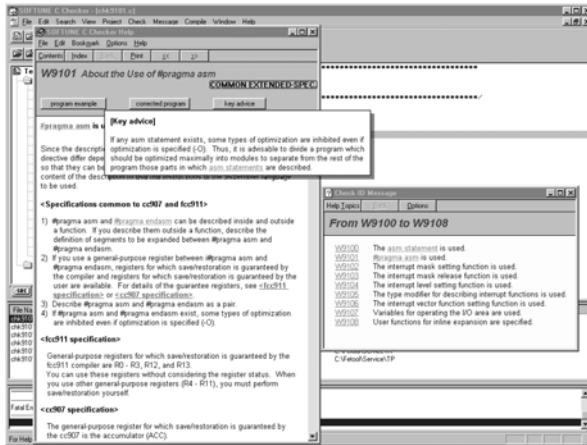

- Quality-related messages listed

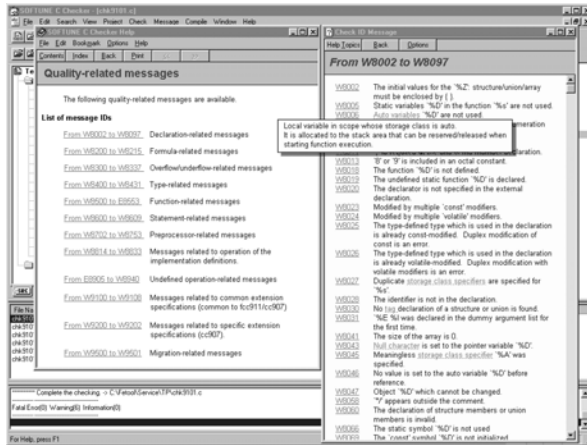

2) SOFTUNE V3 C Analyzer

Designed to meet the following user situations:

- One wishes to examine a program's structure or processing, but the programmer is absent or documentation is unavailable.
- During program development, one wishes to create a structural program while taking into account structure and processing.
- One wishes to examine the range of effects caused by program modification.
- One wishes to create a program's internal documentation.
- One wishes to explore the possibilities of a more efficient program.

The structure and usage of data in a C-language source program are displayed visually, and the internal data structure, functional tree, stack usage and other information can be acquired and stored in a file.

(1) Outline

Recent software (ROM) for embedded microcontrollers is increasingly extending its development scale. This situation is created from development by many programmers, diversion of existing resources, and use of package programs. This development support tool statically analyzes the C-source program to visually display and print the function-to-function structure, reference data, and statistical data. In addition to generating the information required for design and maintenance, the development support tool also provides functions for development aimed at embedded applications. These functions (maximum stack size calculation) are specific to the C compilers (fcc911s, fcc907s, fcc896s) used for Fujitsu microcontrollers (FR family, F²MC-16 family, and F²MC-8L/8FX family).

(2) Features

- Displays and prints the function-to-function structure, reference data, and statistical data.
- Supports the embedded capability of C compilers (fcc911/fcc911s, cc907/fcc907s, and fcc 896s) for Fujitsu microcontrollers (FR family, F²MC-16 family and F²MC-8L/8FX family).
- Provides easy operation and simple display over a GUI.

(3) Explanation of Features

The following data is enabled for development, maintenance, and higher porting efficiency.

- Graphic flow
This feature displays the "call" function in the block structure way. It also allows the display of the entire function and calls from any function and the retrieval of functions.
- Logic flow
This feature visually displays the internal structure of the C-source program.
For example, it shapes the control structure of `for` and `switch` statements and structure declarations. A jump feature for retrieval by functions, variable, tag, and macro names is also provided.
- Displaying statistical data
This feature displays the complexity and line count of a program's every function, the source of destination function name, and the count of appearances of `if`, `for` and `asm` statements, etc.
- Displaying argument data
This feature displays data about the function-called file name and line number, the return value of the declared function, and the type of argument. It also checks the adjustability of dummy arguments with actual arguments.
- Displaying cross-reference data
This feature displays functions, variables, tag and macro declarations in its function and its line number.
- Displaying global data
This feature displays the functions using global variables. It also detects unused global variables.
- Program checking
This feature checks and displays the adjustability of dummy arguments with actual arguments.
- Calculating the maximum amount of stacks used
This feature calculates and displays the amount of stacks used in the entire function, as well as in any other functions. This calculation is made on the basis of the output of C compilers (fcc911/fcc911s, fcc907/fcc907s, and fcc896s) for Fujitsu microcontrollers (FR family, F²MC-16 family and F²MC-8L/8FX family).

8-bit Proprietary F²MC-8L/8FX Family Support Tools

- Displaying graphic flow

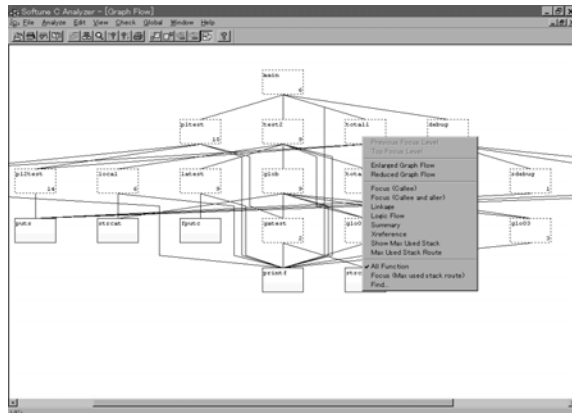

- Displaying logic flow, statistical and cross-reference data

Variable & Function name	Attributes	Type	Line Number			
i		variable	char [255]	Def: 134	Use: 137	139
g1		variable	char *	Def: 134		
g2		variable	char *	Def: 136		
gatest		function definition prototype	void F(gate)	Def: 140		
g101		function definition prototype	void F(g1)	Def: 142		
g102		function definition prototype	void F(g2)	Def: 143		
g103		function definition prototype	void F(g3)	Def: 144		
g10		function definition prototype	void F(g)	Def: 130		
i		parameter	int	Def: 131		

- Displaying logic flow (focus), argument and global data

Name	Type	Function name
i	char [255]	gatest test2 g1
g1	char *	g101 g102
_ptr_file	_PTRFILE *	gatest

- Displays stack use volume (green numbers) and largest stack configuration (orange numbers)

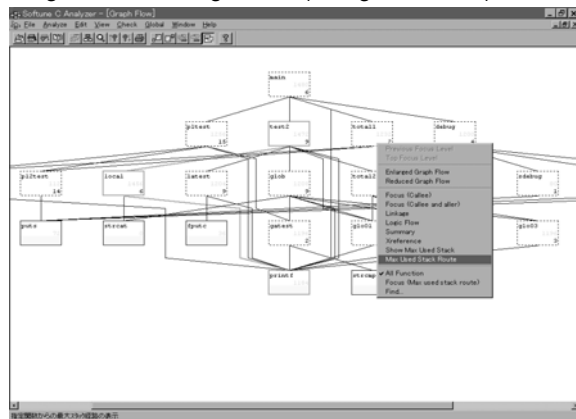

8-bit Proprietary F²MC-8L/8FX Family Support Tools

SOFTUNE V3 Support Software Product List (F²MC-8L/8FX Family)

Software		Part number *1 (Maintenance number)	Remarks
Pack Products	SOFTUNE V3 Professional Pack	SP3603Z008-P01 (SP3603Z008-P01-M)	SOFTUNE V3 workbench SOFTUNE V3 C compiler SOFTUNE V3 assembler pack SOFTUNE V3 analyser SOFTUNE V3 checker
Compatible emulator hardware		MB2140 series - MB2141A/B - MB2144-505/508	-
Personal computers	Operating machine	FMV and similar IBM compatibles	-
	Operating OS	WindowsXP Windows2000	-
	Media	CD-ROM *2	-

*1: The product code suffix (Pxx) indicates the number of licenses.

The part number is an ordered number of the newest version.

Please contact us if purchasing the previous version as a different part is used.

*2: An electronic manual (PDF format) is provided with each product (Japanese and English).

Printed manuals are sold separately. Licensing of each product is available in a number of forms (3, 5 or 10 copies).

8-bit Proprietary F²MC-8L Family Support Tools

Support Hardware and F²MC- Family Evaluation Tools

MB2140 Series

- Microcontroller operating voltage: +2.7V to +5.5V
The range (Max. and Min.) of Microcontroller operating voltage and operating frequency depend on each Microcontroller.
See the document including Data Sheet and check the range of Microcontroller operating voltage and operating frequency.
- Supports debugging of source level (in assembly, C languages, a mixed indicator)
- Simplified GUI operation using pull-down menu and buttons
- On-The-FLY function (commands can be run during microcontroller execution and reference memory)
- Powerful real time trace function
- Displays source codes, variables, register, memory and trace on multi windows
- Event trigger allows a wide range of conditions to be specified (× 8)
- Sequential control in 8 conditions and 8 levels
- Performance measurement function (measurement of execution speed between two points, iteration count measurement)
- C₀ coverage measurement function (program execution coverage rate measurement)
- Host I/F (standard accessories) : RS-232C (max 115 Kbps) , LAN (10BASE-T)





System Overview

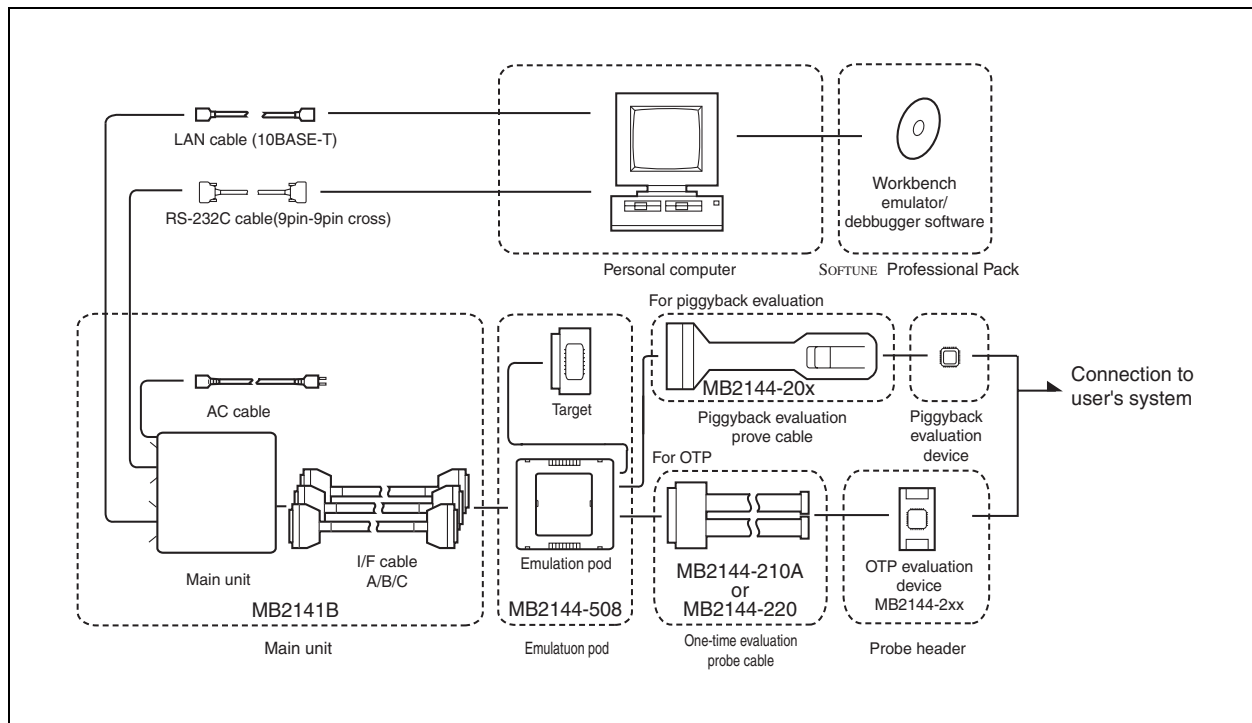

System configuration

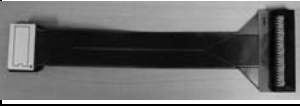

8-bit Proprietary F²MC-8L Family Support Tools

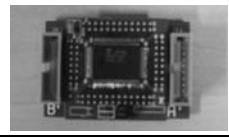
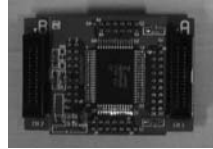
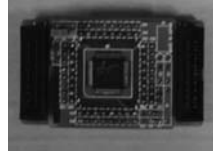
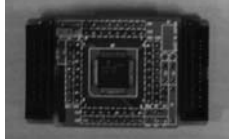
Name	Part number	Remarks	Overview
Main unit	MB2141B	For the F ² MC-8L family Power supply voltage: 100 V or 200 V. Host I/F: RS-232C(115 Kbps) , LAN (10BASE-T) Dimensions: W210 × D297 × H77 mm Weight: 2.9 kg Includes: manual	
Emulation pod *6	MB2144-508	For the F ² MC-8L family Dimensions:158mm(with) × 126mm(depth) × 38mm(height), Weight: 0.5kg Includes: simple target (MB89T625) , manual	
Piggyback/evaluation (PV) probe cable	MB2144-201	For DIP-28, piggyback/evaluation package: MDIP-64C-P02	
	MB2144-202	For LCC-32 rectangular, piggyback/evaluation package: MQP-64C-P01, MQP-80C-P01, MQP-100C-P02	
	MB2144-203	For LCC-32 square, piggyback/evaluation package: MQP-48C-P01, MQP-100C-P02	
One-time evaluation probe cable	MB2144-210A or MB2144-220	Use in conjunction with the probe header for each product type.	
One-time evaluation probe header	MB2144-211-01A *1	For the MB89860 series (QFP-80), standard options are mounted on MB89P867	
	MB2144-214-01A *2	For the MB89810A series (QFP-64), default options are mounted on MB89P817A	
	MB2144-217-01 *4	For the MB89P585B (LQFP-64), default options are mounted on MB89P585B	
One-time evaluation probe header	MB2144-224-01 *7	For the MB89P589B (LQFP-64), default options are mounted on MB89P589B	
	MB2144-225-01 *4	For the MB89P585BW (LQFP-64) , default options are mounted on MB89P585BW	
	MB2144-227-01 *7	For the MB89F051 (LQFP-64), default options are mounted on MB89F051	

*1: Includes one Q-pack for QFP-80 (model: TQPACK080RA: made by Tokyo Eletech Ltd.)

Note: Care is required in printed circuit board pattern design because the position of the board connector part (the flat section at the pin tips) of the Q-pack differs from the mass production product package (the Q-pack pins are shifted a few millimeters inwards).

8-bit Proprietary F²MC-8L Family Support Tools

- Includes one Q-socket for QFP-80 (model: TQSOCKET080RAG: made by Tokyo Eletech Ltd.)
- *2: Includes one Q-pack for QFP-64 (model: TQPACK064RZ: made by Tokyo Eletech Ltd.)
Note: Care is required in printed circuit board pattern design because the position of the board connector part (the flat section at the pin tips) of the Q-pack differs from the mass production product package (the Q-pack pins are shifted a few millimeters inwards).
Includes one Q-socket for QFP-64 (model: TQSOCKET064RZG: made by Tokyo Eletech Ltd.)
- *3: Includes one IC socket for SH-DIP-64 (model: IC83-64075-GS4: made by Yamaichi Electronics Inc.)
- *4: Includes one Q-pack for LQFP-64 (model: TQPACK064SD: made by Tokyo Eletech Ltd.)
Note: Care is required in printed circuit board pattern design because the size of the foot pattern of the Q-pack differs from the mass production product package (the Q-pack pins are shifted a few millimeters inwards).
Includes one Q-socket for LQFP-64 (model: TQSOCKET064SDW: made by Tokyo Eletech Ltd.)
- *5: Includes one HQ-pack for QFP-64 (model: TQPACK064SA: made by Tokyo Eletech Ltd.)
Includes one Q-socket for QFP-64 (model: TQSOCKET064SAW: made by Tokyo Eletech Ltd.)
Note: Care is required in printed circuit board pattern design because the size of the foot pattern of the Q-pack differs from the mass production product package (the Q-pack pins are shifted a few millimeters inwards).
- *6: Interchangeability to MB2114-505.
- *7: Includes one NQ-pack for LQFP-64 (model: NQPACK064SB: made by Tokyo Eletech Ltd.)
Includes one HQ-pack for LQFP-64 (model: HQPACK064SB140: made by Tokyo Eletech Ltd.)
Note: Care is required in printed circuit board pattern design because the size of the foot pattern of the Q-pack differs from the mass production product package (the Q-pack pins are shifted a few millimeters inwards).
- *8: Includes a pair of Q-pack and Q-socket for QFP-48 (model: TQPACK048SA, TQSOCKET048SAW: by Tokyo Eletech Ltd.)
Note: The dimension of foot patterns is somewhat different between Q-pack and mass production IC packages.
Be careful in designing patterns of print-circuit board.

Contact for details:

*1, *2, *4, *5, *7, *8

- USA: OESS Co. San Jose Office TEL(408)437-1582
- Europe Germany: OESS GmbH TEL(06106)2857890
- Tokyo Eletech Co, Ltd. TEL(81)3-3820-7141

*3

- USA: Yamaichi Electronics Inc. TEL(408)4520797
- Europe
 - Denmark: Elmatok A.S. TEL(65)351446
 - England: Radiatron Components Ltd. TEL(01)8911221
 - AB Connector Ltd. TEL(0604)712000
 - Finland: Dualtek Oy TEL(80)8019911
 - France: Manudax-France TEL(1)4342-2050
 - Germany: Macrotron AG TEL(089)4208148
 - Glyn GmbH TEL(49)61278077
 - Connector Service GmbH TEL(089)429277
 - Italy: Eurosab International s.r.l TEL(02)93169781
 - Spain: S.A Generalde Imporciones Electronicas TEL(1)416-92-61
 - Sweden: Bexab Electronics TEL(08)7680560
 - Switzerland: Sicovend AG TEL(01)8303161
- Asia
 - Singapore: Yamco Electronics Pt. Ltd. TEL(336)6522
 - Korea: Asia Yamaichi Electronics, Inc. TEL(02)482-7263
 - Taiwan: Sing Way Co. TEL(02)718-5971
 - Joung Lai Trading Co. Ltd. TEL(02)754-1022

- Select the probe cable to match the microcontroller being evaluated.
- Use this evaluation tool by connecting to the user system or to the evaluation device on the user system.
- When using a piggyback/evaluation (PV) device, obtain the piggyback/evaluation (PV) device separately.
- A one-time evaluation or EPROM evaluation type evaluation device is mounted in the one-time evaluation or EPROM evaluation probe cable.

8-bit Proprietary F²MC-8L Family Support Tools

Emulator specification for F²MC-8L

Emulator series		MB2140 series emulator	
Main unit		Main unit: MB2141B	
Pod		MB2144-508	MB2144-505
Target microcontroller		F ² MC-8L	F ² MC-8L
Operating power supply voltage of microcontroller *		2.7 to 5.5 V	
Operating frequency of microcontroller *		Internal: 32 kHz to 20 MHz External: 8 kHz to 5 MHz	Internal: 32 kHz to 16 MHz External: 8 kHz to 4 MHz
Debugger / OS		SOFTUNE V3 Workbench WindowsXP/2000	SOFTUNE V3 Workbench WindowsXP/2000
Simple target		Attachment (MB89T625)	No
Memory area		<ul style="list-style-type: none"> - User's memory area - Emulation memory area - Undefined area 	
User's memory area		<ul style="list-style-type: none"> - Max 20 area - Unrestricted of area size - READ, WRITE: an access attribute setup is possible. 	
Emulation area	Size	64 Kbyte	
	Mapping unit	1 byte unit, 20area	
	Access attribute	READ, WRITE, GUARD, NOGUARD	
Mirror area: It is used at on-the-fly.		It is 5 area in all about copy area of user's memory area and emulation memory area.	
Execution control		<ul style="list-style-type: none"> - Continuous execution- The automatic change by sauce display - Step execution- 1 step execution of a sub routine and a function - Machine language command unit- Permission/prohibition of interrupt - C language sauce line unit- Permission/prohibition of a watch dog reset function 	
Break		<ul style="list-style-type: none"> - Instruction execution break: 64 K point - Data access break: 64 K point - Sequential end break - Garded access break - Trace buffer full break - Performance buffer full break - Forced break 	
Trace capacity		<ul style="list-style-type: none"> - Single trace: 32 K cycles (ON/OFF of trace by the event trigger and the sequencer is possible.) - Multi trace: 2 K blocks (1 block is 8 cycles before and after an event trigger.) 	
Trace data		<ul style="list-style-type: none"> - Address - Data - Status Access status: READ, WRITE, CODE Inside status of a device: reset, a hold, and data are effective/invalid. - External probe data - The execution level of a sequencer 	
Display form of trace data		- Machine cycle - Instruction mnemonic - Sauce line	
Event trigger condition setup	The number of points	8	
	Trigger conditions	<ul style="list-style-type: none"> - The AND conditions of address, data, external probe and status. - All conditions can be specified of don't care per 1 bit. 	
	Sequential level	8	
	Trigger path	Max 16M time	

(Continued)

8-bit Proprietary F²MC-8L Family Support Tools

(Continued)

Emulator series		MB2140 series emulator	
Main unit		Main unit: MB2141B	
Pod		MB2144-508	MB2144-505
Target microcontroller		F²MC-8L	F²MC-8L
On-the-fly function (Command execution at the MCU operation)		Yes	
Execution time measurement		<ul style="list-style-type: none"> - Performance measurement function : 4 domains - Measurement domain : event trigger condition setting domain - Measurement of the minimum, the maximum, and average time is possible. - It is 1 μs unit (initial value) is a maximum of 70 minutes. - It is 100 ns unit and is a maximum of 7 minutes. 	
Co coverage (Rate measurement of program execution complete coverage)		The range of a debugging domain setup : A maximum of 32 domain An access attribute (R/W) setup is possible.	
Host computer		Personal computer	
Host interface		<ul style="list-style-type: none"> - RS-232C (115 Kbps) - LAN (10BASE-T) 	
Dimensions, weight (A projection part and a cable part remove.)	Main unit	W210 × D297 × H78 mm, 2.9 kg	
	Pod	W160 × D128 × H40 mm, 0.5 kg	
Power supply for emulator : MB2141B		AC 100-120 V and AC 200-220 V are switched automatically.	

*: The range (Max. and Min.) of Microcontroller operating voltage and operating frequency depend on each Microcontroller.
See the document including Data Sheet and check the range of Microcontroller operating voltage and operating frequency.

8-bit Proprietary F²MC-8L Family Support Tools

F²MC-8L Family Adaptors

(1) Programming Adaptors for F²MC-8L One-Time PROM Microcontrollers and EPROM Microcontrollers

OTPROM microcontrollers	Package (lead pitch, body size)	Package code	Adaptor socket
MB89F051	LQFP-64 (0.65 mm, □12×12 mm)	FPT-64P-M09	FLASH-64QF2-32DP-8LF3 *6
MB89P131PFM MB89P133APFM MB89P135APFM	QFP-48 (0.80 mm, □10×10 mm)	FPT-48P-M13(new) FPT-48P-M04	ROM-48QF2-28DP-8L *1
MB89P147-V1P-SH MB89P147-V2P-SH	SH-DIP-64 (1.778 mm, □58×17 mm)	DIP-64P-M01	ROM-64SD-28DP-8L4 *1
MB89P147-V1PF MB89P147-V2PF	QFP-64 (1.00 mm, □14×20 mm)	FPT-64P-M06	ROM-64QF-28DP-8L4 *1
MB89W147-V1C-SH MB89W147-V2C-SH	SH-DIP-64 (1.778 mm, □56.9×18.75 mm)	DIP-64C-A06	ROM-64SD-28DP-8L4 *1
MB89P155-10XPF MB89P155-20XPF	QFP-80 (0.80 mm, □14×20 mm)	FPT-80P-M06	ROM-80QF-28DP-8L3 *1
MB89P155-10XPFM MB89P155-20XPFM	LQFP-80 (0.65 mm, □14×14 mm)	FPT-80P-M11	ROM-80QF2-28DP-8L2 *1
MB89P155-10XPFV MB89P155-20XPFV	LQFP-80 (0.50 mm, □12×12 mm)	FPT-80P-M05	ROM-80SQF-28DP-8L *1
MB89P165-10XPF MB89P165-20XPF	QFP-80 (0.80 mm, □14×20 mm)	FPT-80P-M06	ROM-80QF-28DP-8L3 *1
MB89P165-10XPFM MB89P165-20XPFM	LQFP-80 (0.65 mm, □14×14 mm)	FPT-80P-M11	ROM-80QF2-28DP-8L2 *1
MB89P165-10XPFV MB89P165-20XPFV	LQFP-80 (0.50 mm, □12×12 mm)	FPT-80P-M05	ROM-80SQF-28DP-8L *1
MB89P185-xxxPF	QFP-64 (1.00 mm, □14×20 mm)	FPT-64P-M06	ROM-64QF-28DP-8L3 *1
MB89P185-xxxPFM	LQFP-64 (0.65 mm, □12×12 mm)	FPT-64P-M09	ROM-64QF2-28DP-8L2 *1
MB89P195-xxxPF	SOP-28 (1.27 mm, □17.75×8.6 mm)	FPT-28P-M17	ROM-28SOP-28DP-8L *3
MB89P195-xxxP	DIP-28 (2.54 mm, □35.73×13.8 mm)	DIP-28P-M05	ROM-28DP-28DP-8L *3
MB89P195A-xxxPF	SOP-28 (1.27 mm, □17.75×8.6 mm)	FPT-28P-M17	ROM-28SOP-28DP-8L *3
MB89P195A-xxxP	DIP-28 (2.54 mm, □35.73×13.8 mm)	DIP-28P-M05	ROM-28DP-28DP-8L *3
MB89F202P-SH	SH-DIP-32 (1.778 mm, □28×8.9 mm)	DIP-32P-M06	TEF110-89F202-PSH *7 (ROM3-DIP32P-M06-8L: for serial programmer)
MB89F202YPFV	SSOP-34 (0.65 mm, □11×6.1 mm)	FPT-34P-M03	TEF110-89F202-PFV *7 (ROM3-FPT34P-M03-8L: for serial programmer)
MB89P485P-SH MB89P485LPFM	LQFP-64 (0.65 mm, □12×12 mm)	FPT-64P-M09	ROM2-64QF2-32DP-8LA3 *6
MB89P485PFM MB89P485LP-SH	DH-DIP-64 (1.778 mm, □58×17 mm)	DIP-64P-M01	ROM2-64SD-32DP-8LA3 *6
MB89F499	QFP-100 (0.65 mm, □14×20 mm)	FPT-100P-M06	FLASH-100QF-32DP-8LF2 *6
MB89P538P-SH	SH-DIP-64 (1.778 mm, □58×17 mm)	DIP-64P-M01	ROM-64SD-32DP-8LA2* 2
MB89P538PF	QFP-64 (1.00 mm, □14×20 mm)	FPT-64P-M06	ROM-64QF-32DP-8LA2 *2
MB89P538PFM	LQFP-64 (0.65 mm, □12×12 mm)	FPT-64P-M09	ROM-64QF2-32DP-8LA *2
MB89F538P-SH	SH-DIP-64 (1.778 mm, □58×17 mm)	DIP-64P-M01	FLASH-64SD-32DP-8LF *6
MB89F538PF	QFP-64 (1.00 mm, □14×20 mm)	FPT-64P-M06	FLASH-64QF-32DP-8LF *6
MB89F538PFM	LQFP-64 (0.65 mm, □12×12 mm)	FPT-64P-M09	FLASH-64QF2-32DP-8LF2 *6
MB89P558APFV	LQFP-100 (0.5 mm, □14×14 mm)	FTP-100P-M05	ROM-100SQF-32DP-8LA2*2
MB89P558APFT	TQFP-100 (0.4 mm, □12 × 12 mm)	FTP-100-M18	ROM-100TQF-32DP-8LA*2
MB89P568PF	QFP-80 (0.8 mm, □14×20 mm)	FPT-80P-M06	ROM-80QF-32DP-8LA2 *2
MB89P568PFM	LQFP-80 (0.65 mm, □14×14 mm)	FPT-80P-M11	ROM-80QF2-32DP-8LA2
MB89P568PFV	LQFP-80 (0.5 mm, □12×12 mm)	FPT-80P-M05	ROM-80SQF-32DP-8LA *2
MB89P585B/BW	LQFP-64 (0.5 mm, □10×10 mm)	FPT-64P-M03	ROM-64LQF-32DP-8LA *4
MB89P589B	LQFP-64 (0.65 mm, □12×12 mm)	FPT-64P-M09	ROM-64QF2-32DP-8LA *4

(Continued)

8-bit Proprietary F²MC-8L Family Support Tools

(Continued)

OTPROM microcontrollers	Package (lead pitch, body size)	Package code	Adaptor socket
MB89W637C-ES-SH	SH-DIP-64 (1.778 mm, □57×18 mm)	DIP-64C-A06	ROM-64SD-28DP-8L *1
MB89P665P-SH	SH-DIP-64 (1.778 mm, □58×17 mm)	DIP-64P-M01	ROM-64SD-28DP-8L *1
MB89P665PF	QFP-64 (1.00 mm, □14×20 mm)	FPT-64P-M06	ROM-64QF-28DP-8L *1
MB89P677APF	QFP-80 (0.80 mm, □14×20 mm)	FPT-80P-M06	ROM-80QF-28DP-8L2 *1
MB89P677APFM	LQFP-80 (0.65 mm, □14×14 mm)	FPT-80P-M11	ROM-80QF2-28DP-8L *1
MB89P689PF	QFP-100 (0.65 mm, □14×20 mm)	FPT-100P-M06	ROM-100QF-32DP-8LA *2
MB89P689PFV	LQFP-100 (0.50 mm, □14×14 mm)	FPT-100P-M05	ROM-100SQF-32DP-8LA *2
MB89P808PF	QFP-100 (0.65 mm, □14×20 mm)	FPT-100P-M06	ROM-100QF-32DP-8LA2 *2
MB89P808PFV	LQFP-100 (0.50 mm, □14×14 mm)	FPT-100P-M05	ROM-100SQF-32DP-8LA3 *2
MB89P817APF	QFP-64 (1.00 mm, □14×20 mm)	FPT-64P-M06	ROM-64QF-28DP-8L*1
MB89P825PFM	LQFP-80 (0.65 mm, □14×14 mm)	FPT-80P-M11	ROM-80QF2-28DP-8L3*1
MB89P857P-G	SH-DIP-64 (1.778 mm, □58×17 mm)	DIP-64P-M01	ROM-64SD-28DP-8L*1
MB89P857PF	QFP-64 (1.00 mm, □14×20 mm)	FPT-64P-M06	ROM-64QF-28DP-8L*1
MB89W857	QFP-64 (1.00 mm, □14×20 mm)	FPT-64C-A02	ROM-64QF-28DP-8L5
MB89W857C-ES-SH	SH-DIP-64 (1.778 mm, □56.9×18.75 mm)	DIP-64C-A06	ROM-64SD-28DP-8L*1
MB89P867PF	QFP-80 (0.80 mm, □14×20 mm)	FPT-80P-M06	ROM-80QF-28DP-8L2*1
MB89W867CF-ES	QFP-80 (0.80 mm, □14×20 mm)	FPT-80C-A02	ROM-80QF-28DP-8L2*1
MB89P899PF	QFP-100 (0.65 mm, □14×20 mm)	FPT-100P-M06	ROM-100QF-32DP-8LA*2
MB89P928PF	QFP-80 (0.80 mm, □14×20 mm)	FPT-80P-M06	ROM-80QF-32DP-8LA*2
MB89P935BPFV	SSOP-30 (0.65 mm, □9.7×5.6 mm)	FPT-30P-M02	ROM3-FPT30M02-8L*5 (Only the Serial on the programmer corresponds.)
MB89P945PF	QFP-48 (0.80 mm, □12×12 mm)	FPT-48P-M16	ROM-48QF-28DP-8L3*1
MB89P979PFV	Under planning LQFP-80 (0.50 mm, □12×12 mm)	FPT-80P-M05	ROM-80SQF-32DP-8LA2*2
MB89P985PFM	LQFP-64 (0.65 mm, □12×12 mm)	FPT-64P-M09	ROM-64QF2-28DP-8L4*1
MB89P985PFV	LQFP-64 (0.50 mm, □10×10 mm)	FPT-64P-M03	ROM-64SQF-28DP-8L3*1

Contact for details: Tokyo Japan: Sunhayato Corp. TEL +81-3-3984-7791, FAX +81-3-3971-0535

Advanced Interconnectics: <http://www.advantest.co.jp/en-index.shtml>

Notes: Use a general-purpose EPROM programmer that is able to program a MBM27C256A or MBM27C1000.

A gang EPROM programmer is not recommended. Also, contact Fujitsu Microelectronics for programming mounted devices. The recommended screening practice before mounting is high-temperature aging (+150°C, 48H).

*1:MBM27C256A equivalent.

Recommended EPROM programmer: UNISITE, 3900, 2900 (Data I/O FAX (81) 3-3779-2203)
1890A, 1891 (Minato Electronics FAX (81) 45-591-6451)

*2:MBM27C1000 equivalent.

Recommended EPROM programmer: same as *1

*3:MODEL 1890A (Ver. 2.1) + MOS unit OU-910 (Ver. 4.07): Minato Electronics FAX (81) 45-591-6451
AF9708 (Ver. 1.40 or higher), AF9709 (Ver. 1.40 or higher), AF9723 (Ver 1.50 or higher): Flash Support Group, Inc.

*4:MODEL 1890A + MOS unit (Ver. 4.32r) + 3V board (ML01-781): Minato Electronics FAX (81) 45-591-6451
AF9708, AF9709/B, AF9723: Flash Support Group, Inc. <http://www.j-fsg.co.jp/e/top.html>

*5:Serial programming mode only: Yokogawa Digital Computer Co.
Interface

*6:MODEL 1890A + OU910 (Ver 4.32t1 or higher) , Conversion board : H910-1148 : Minato Electronics
AF9708, AF9709/B: Flash Support Group, Inc. <http://www.j-fsg.co.jp/e/top.html>

*7:Flash Support Group, Inc. <http://www.j-fsg.co.jp/e/top.html>

8-bit Proprietary F²MC-8L Family Support Tools

(2) IC Package Conversion Adaptors for the F²MC-8L Family

Target microcontroller	Package conversion (up → down)	IC package conversion adaptor model
MB89610 series MB89630R series	SH-DIP-64 → QFP-64 (1.00 mm pitch)	64SD-64QF-8L
	SH-DIP-64 → QFP-64 (0.65 mm pitch)	64SD-64QF2-8L
	SH-DIP-64 → SQFP-64 (0.5 mm pitch)	64SD-64SQF-8L
MB89120/A series MB89130/A series	QFP-48 (0.80 mm pitch) → SQFP-48 (0.50 mm pitch)	48QF-48SQF-8L-UP 48QF-48SQF-8L-DWN
MB89190/A series	QFP-48 (0.80 mm pitch) → SOP-28	48QF-28SOP-8L
	QFP-48 (0.80 mm pitch) → DIP-28 (2.54 mm pitch)	48QF-28DP-8L
	QFP-48 (0.80 mm pitch) → SHDIP-28 (1.778 mm pitch)	48QF-28SD-8L
MB89150/A series MB89160/A series MB89560A series	QFP-80 (0.80 mm pitch) → QFP-80 (0.65 mm pitch)	80QF-80QF2-8L-UP 80QF-80QF2-8L-DWN
MB89150/A series MB89160/A series MB89560A series	QFP-80 (0.80 mm pitch) → LQFP-80 (0.5 mm pitch)	80QF-80QF2-8L-UP 80QF-80SQF-8L-DWN
MB89550A series	LQFP-100 (0.50 mm pitch) → TQFP-100 (0.4 mm pitch)	100SQF-100TQF-8L
MB89650A series	LQFP-100 (0.50 mm pitch) → QFP-100 (0.65 mm pitch)	100SQF-100QF-8L
MB89863	SH-DIP-64 → QFP-48(0.80 mm pitch)	64SD-48QF-8L
MB89930 series	QFP-48 (0.8 mm pitch) → SSOP-30 (0.65 mm pitch)	48QF-30SOP-8L

Contact for details: Tokyo Japan: Sunhayato Corp. TEL +81-3-3984-7791, FAX +81-3-3971-0535
Advanced Interconnections Corp.: <http://www.advantest.co.jp/en-index.shtml>

■ Evaluation Board for USB

It is an evaluation board corresponding to microcontroller for USB. It contributes to the rise of that the simple evaluation of operation before including in a visitor's system is possible, and development efficiency.

It is constituted by evaluation board for USB, and a main board and a daughter board. A main board is common to each microcontroller products. By changing a daughter board, debugging by In Circuit Emulator combined with the emulator debugger for microcontroller can be performed.

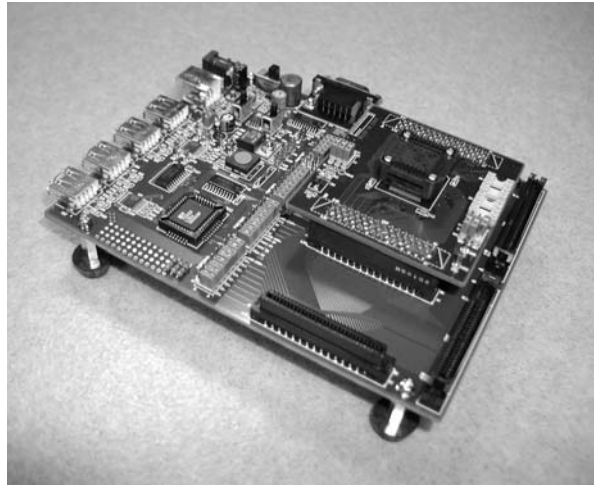

System configuration

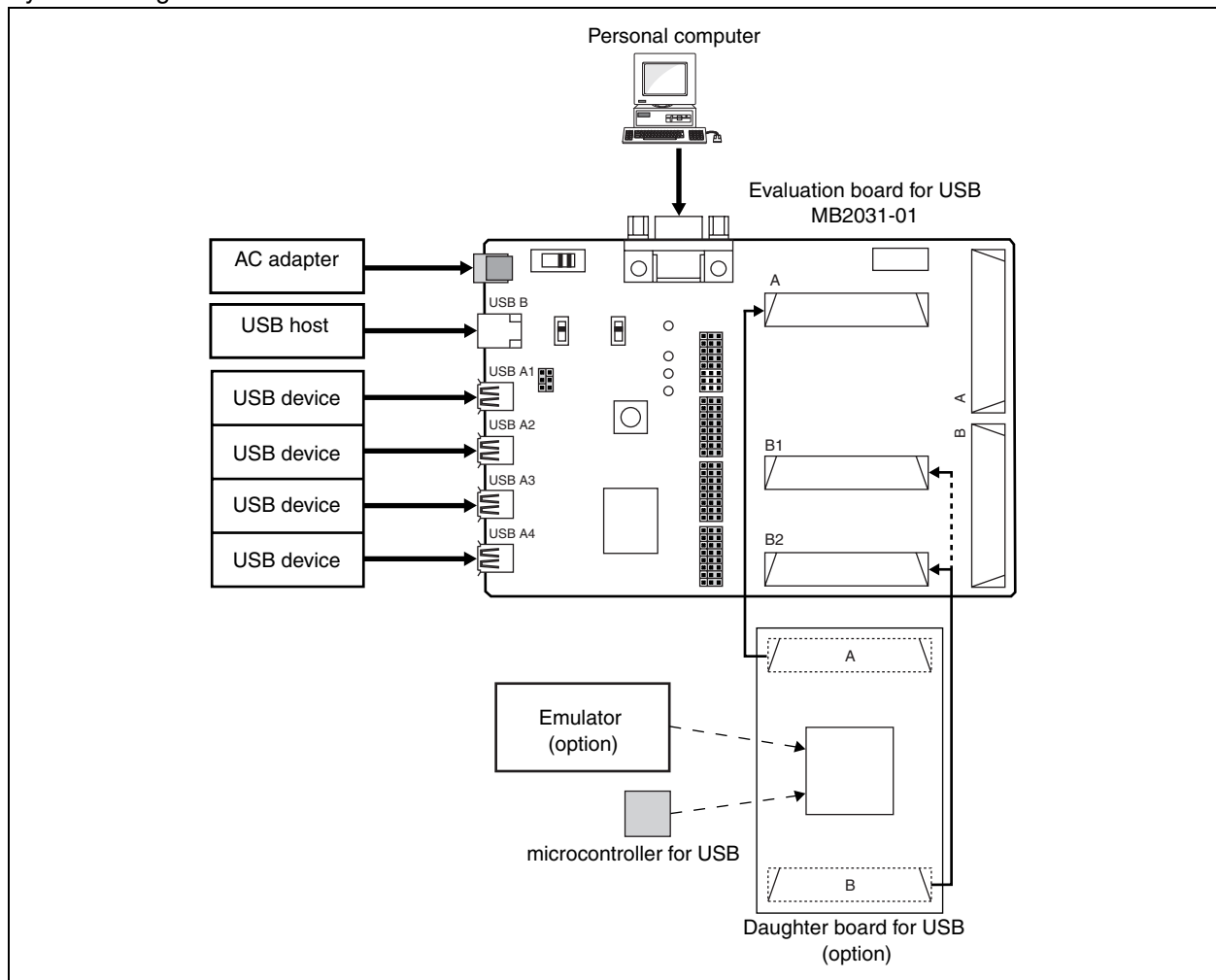

8-bit Proprietary F²MC-8L Family Support Tools

Evaluation board configuration

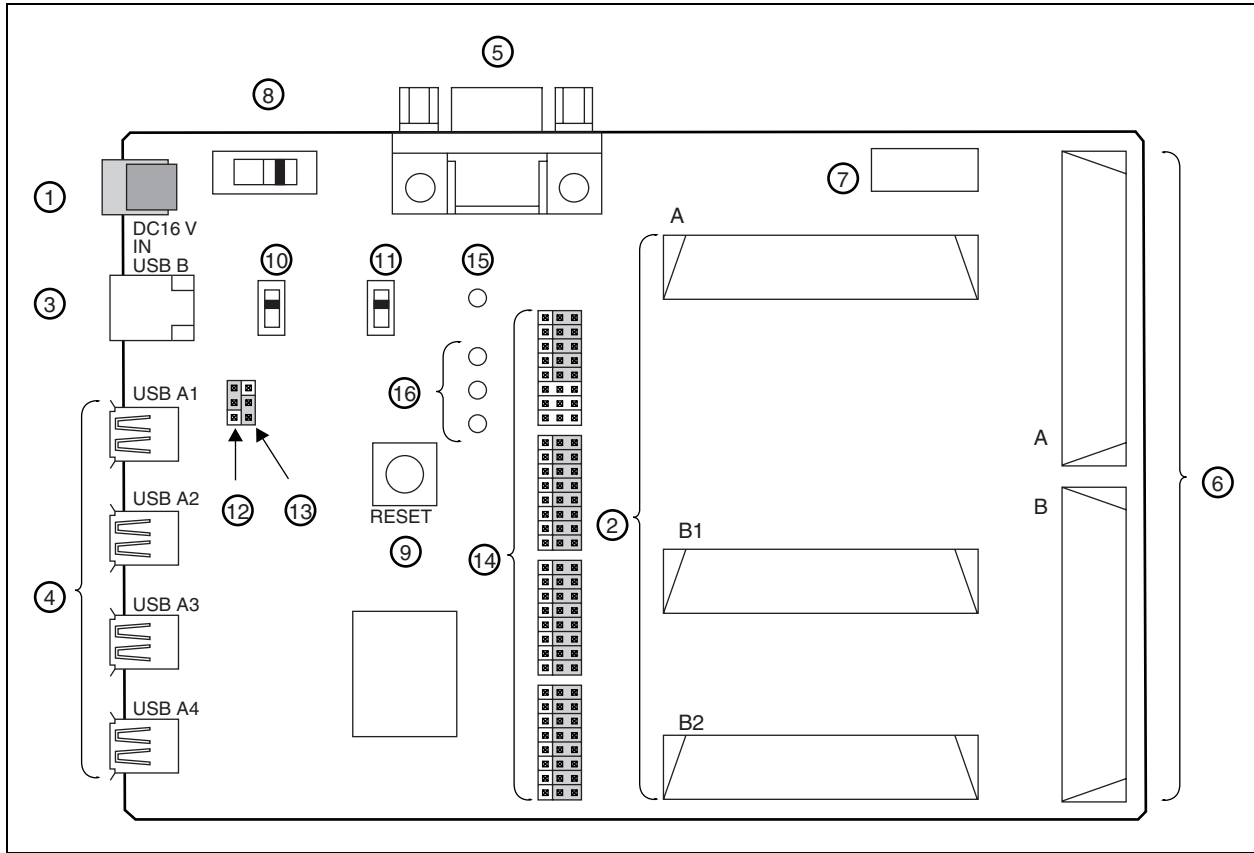

- ① Power connector
- ② Daughter I/F connector

Part number	Target microcontroller	Package
MB2031-10	MB89P585B/BW	LQFP-64 (0.5 mm, □10 mm × 10 mm)
MB2031-11	MB89P589B	LQFP-64 (0.65 mm, □12 mm × 12 mm)
MB2031-20	MB90F334A	LQFP-120 (0.4 mm, □14 mm × 14 mm)

- ③ USB-B connector
- ④ USB-A connector
- ⑤ RS-232C connector
- ⑥ General I/F connector
- ⑦ IC socket for clock mounting
- ⑧ Power switch
- ⑨ Reset switch
- ⑩ USB transmission speed setting switch
- ⑪ USB transmission speed control switch
- ⑫ Short plug for a Power Mode setup (selection of a self-power supply or bus power supply)
- ⑬ Short plug for a MCU Power setup (selection of 3.3 V or 5 V)
- ⑭ Short plug for a functional setup
- ⑮ MCU power LED
- ⑯ USB-LED

Serial on board programmer

The serial on board programming (Fujitsu Microelectronics standard) in Flash memory of the F²MC-16LX family or OTPROM of the F²MC-8L family is supported as the following programmer.

FLASH USB Programmer : Fujitsu Microelectronics

This is a FLASH USB Programmer which feature is the small size and low price, and it allows to program by using the microcontroller with Flash memory, personal computer and adaptor (MB2146-09A-E) at the Flash ROM of microcontroller.

(1) System configuration

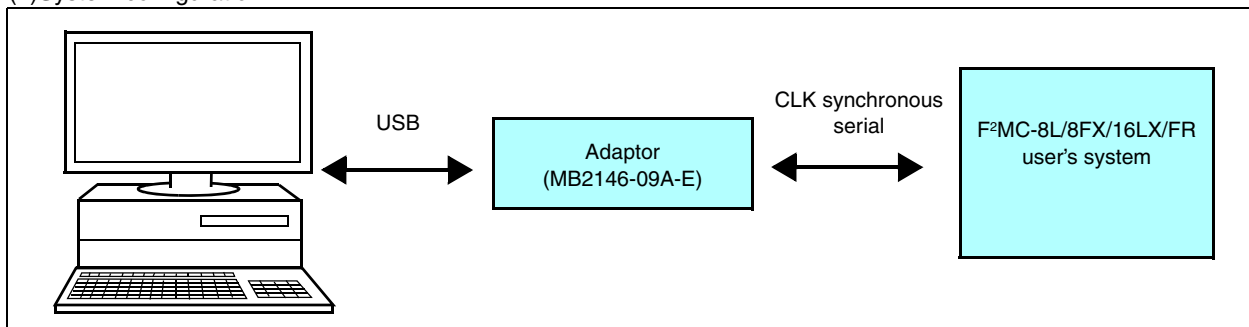

(2) Product configuration

Product name	Part number	Description
Adaptor (programmer)	MB2146-09A-E	F ² MC-8FX ICE and using combinedly (with USB cable)
FLASH USB Programmer	-	Software (download from Web(registration))

(3) Target microcontroller

Version	Target microcontroller
FLASH USB Programmer for 8L/8FX/16LX/FR	MB89F202, MB89F499, MB95F108, MB95F118, MB95F128, MB95F136 MB95F146, MB95F156/M, MB95F168/M

FLASH MCU Programmer : Fujitsu Microelectronics

This is a FLASH MCU Programmer which feature is the small size and low price, and it allows to program by connection the microcontroller with Flash memory and personal computer at the Flash ROM of microcontroller.

(1) System configuration

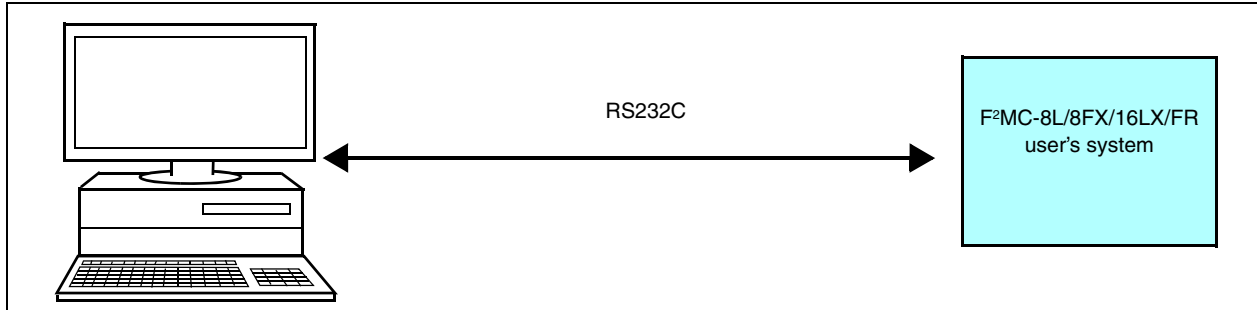

(2) Product configuration

Product name	Part number	Description
FLASH MCU Programmer	-	Software (download from Web(registration))

(3) Target microcontroller

Version	Target microcontroller
F2MC-8L family FLASH MCU Programmer (FLASH)	MB89F051, MB89F217, MB89F499, MB89F538/L
F2MC-8L family FLASH MCU Programmer (MB89F202)	MB89F202
F2MC-8L family OTP Programmer	MB89P215, MB89P935B
F2MC-8FX family FLASH MCU Programmer	MB95F108/H, MB95F118/H, MB95F128H, MB95F146, MB95F156/M, MB95F168/M

8-bit Proprietary F²MC-8FX Family Support Tools

AF220/AF210/AF120/AF110 (Flash microcontroller programmer): Yokogawa Digital Computer

(1) System configuration

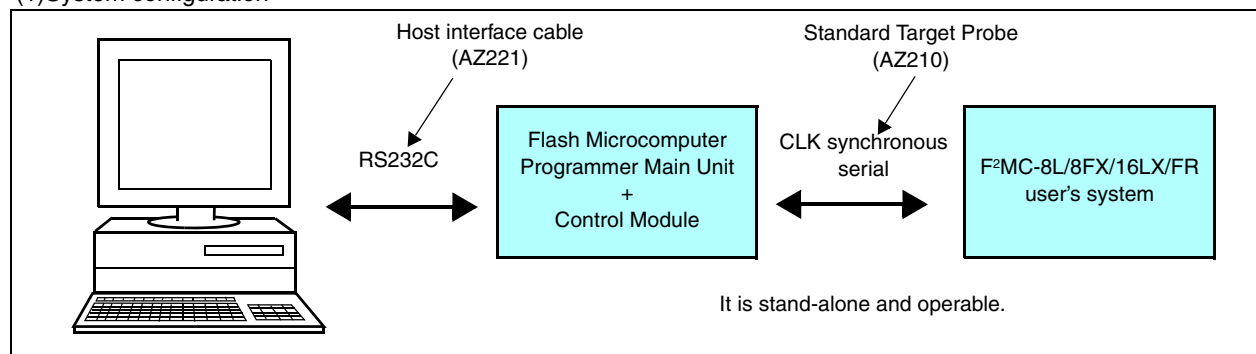

(2) Product configuration

Product name	Part number	Description
Flash Microcontroller Programmer Main Unit	AF220/AC4P	with Ethernet(10Base-T) Interface /100V to 220V Power supply adaptor
	AF210/AC4P	Basic Model /100V to 220V Power supply adaptor
	AF120/AC4P	Single Operation Model with Ethernet Interface /100V to 220V Power supply adaptor
	AF110/AC4P	Single Operation Model /100V to 220V Power supply adaptor
Host Interface Cable	AZ221	Writer exclusive use. RS232C cable for PC/AT
Standard Target Probe	AZ210	Standard Target Probe (a): 1 m
Control Modules	FF002 or FF004A	Control modules for F ² MC-8L OTP microcontroller made by Fujitsu Microelectronics.
Remote Controller	AZ290	Remote Controller
Memory card	/P2	2 MB PC Card
	/P4	4 MB PC Card

Contact for details: Yokogawa Digital Computer Corporation

Although AF200 (Yokogawa Digital Computer) has ceased, the conventional system configuration is also possible for serial onboard writing (a standard for Fujitsu Microelectronics) .

(3) OTPROM microcontroller for programming

OTPROM microcontroller (OTPROM size)	Control Module	Status
MB89F051 (32 KB)	FF201	Supported
MB89F499 (60 KB)	FF201	Supported
MB89F538/L (48 KB)	FF201	Supported
MB89P558A (48 KB)	FF002	Supported
MB89P585B/BW (16 KB)	FF004A	Supported *
MB89P935B (16 KB)	FF004A	Supported *

*: In control module FF004A, AF200 (cereal programmer of an old version) is available.

The AF2XX/AF1XX series will terminate the sales in the end of March, 2007 (The maintenance and repair service will be available for the next 5 years after the end of sale). We have the alternative version (AF400/300, AF600/500 series) which includes the enhanced functions of the AF2XX/AF1XX series. For more information, please contact Yokogawa Digital Computer Corporation. We will continuously provide you the technical support for the subsequent version of Fujitsu Microelectronics microcontrollers.

8-bit Proprietary F²MC-8FX Family Support Tools

AF420/AF620/AF320/AF520 (serial programmer) : Yokogawa Digital Computer

(1) System configuration

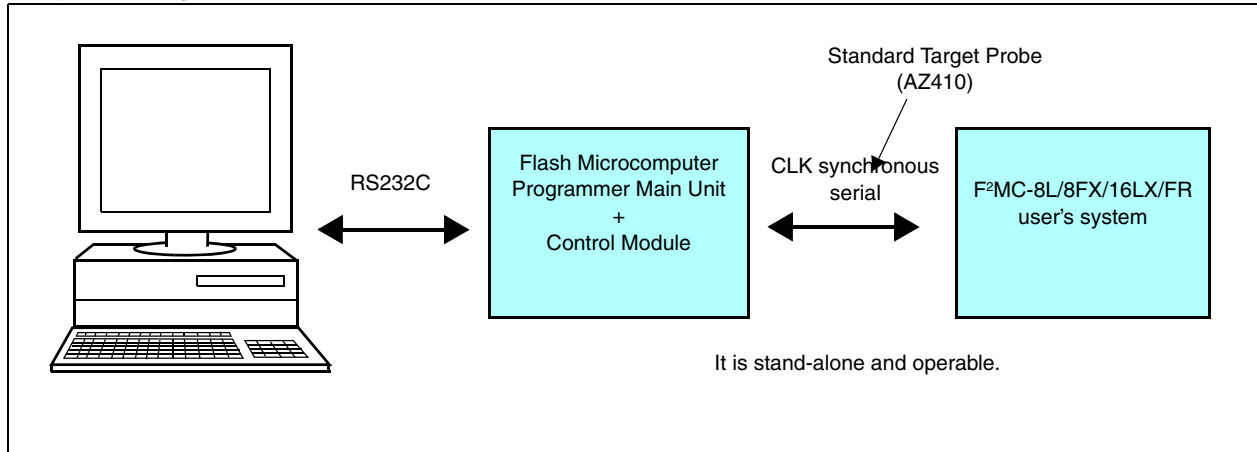

(2) Product configuration

Product name	Part number	Description
Flash Microcontroller Programmer Main Unit	AF420/AC4P	FULL KEY model 100BASE-TX host interface
	AF620/AC4P	FULL KEY model CAN interface 100BASE-TX host interface
	AF320/AC4P	Single KEY model 100BASE-TX host interface
	AF520/AC4P	Single KEY model CAN interface 100BASE-TX host interface
Standard Target Probe	AZ410	Standard Target Probe (a): 1 m
Compact Modules	FF801	Control modules for Fujitsu Microelectronics microcontroller
Remote Controller	AZ490	Remote Controller
Memory card	-	PC Card

Contact for details: Yokogawa Digital Computer Corporation

8-bit Proprietary F²MC-8FX Family Support Tools

ITF2000 (Serial Gang programmer): Interface

(1) System configuration

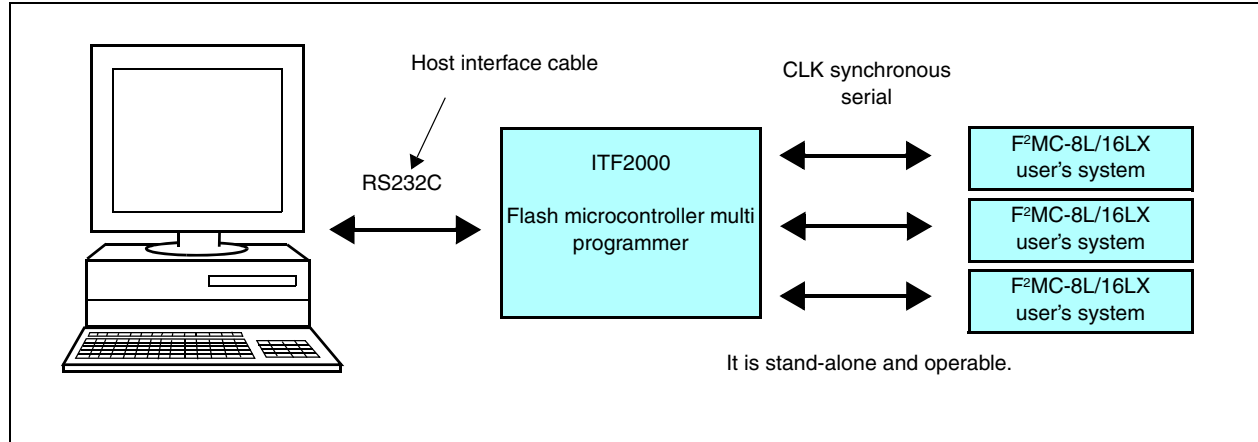

(2) Product configuration

Product	Function
ITF2000	Main unit of Flash microcontroller multi programmer (with remote software)
ISP2000	Adaptor for on board programming (with main cable)
CF002(for F ² MC-8L family)	Control software
WF001/F001(for MB89P935B)	Microcontroller module

(3) Programming adaptor

Part number	Package	Programming adaptor
MB89P935B	SSOP-30	TOP2000/SSOP30TP1/P1 (single) TOP2000/SSOP30TP1/P10 (10 sets)

■ Evaluation tool for F²MC-8FX Family (MB2146 Series)

Features







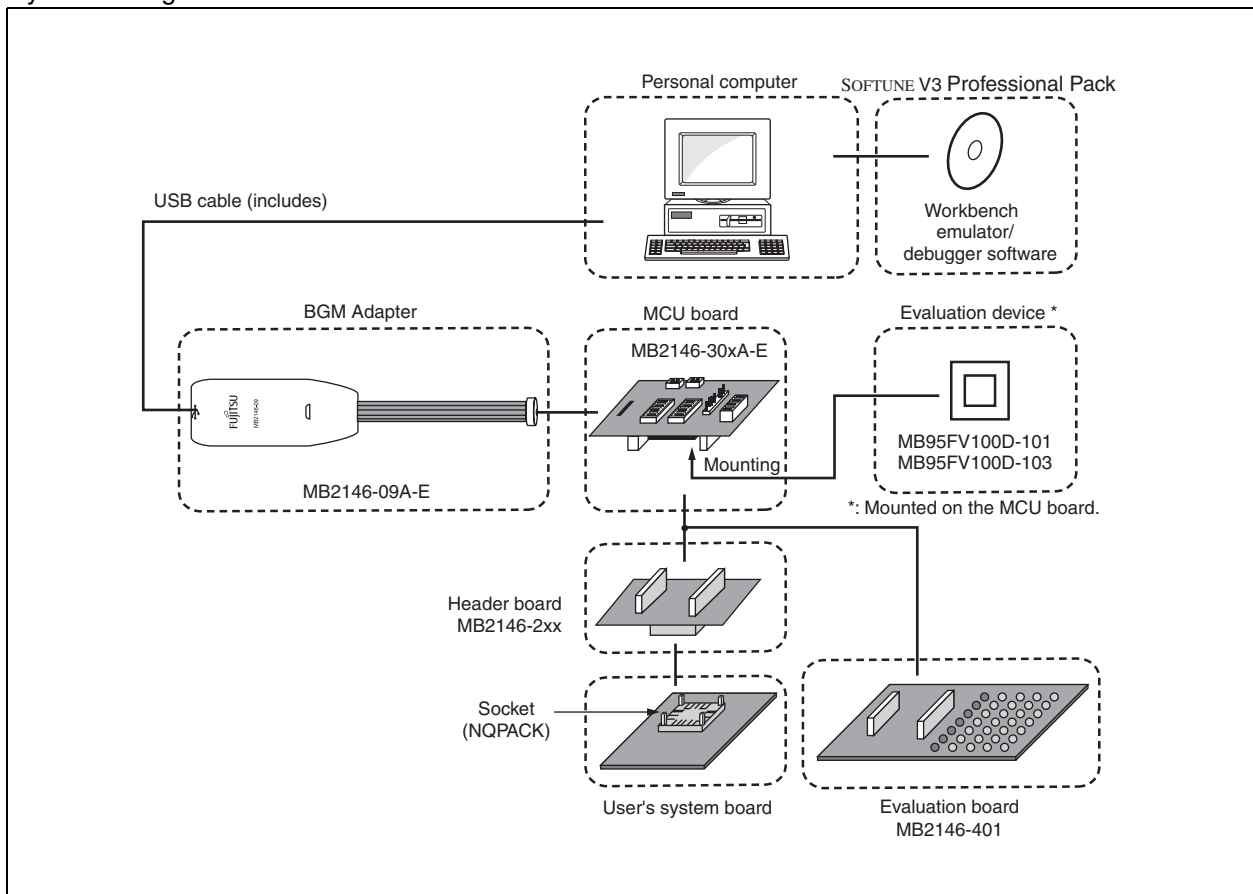



- Microcontroller operating voltage: +2.7 to +5.5 V
The range (Max. and Min.) of Microcontroller operating voltage and operating frequency depend on each Microcontroller.
See the document including Data Sheet and check the range of Microcontroller operating voltage and operating frequency.
- Compact development environment and a light and small BGM adapter
- Since a monitor program is performed in exclusive memory space, it does not consume user memory area.
- Continuation execution, Step execution, a command break, a data break, Sequential break
- Measurement at time
- RAM monitoring
- Instruction trace is possible. (max. 16 branches)
- Host I/F : USB

System Overview

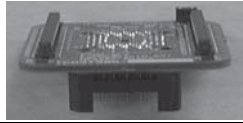
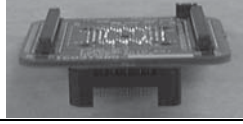
System configuration

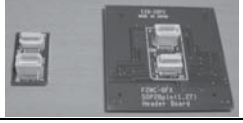

8-bit Proprietary F²MC-8FX Family Support Tools

Name	Part number	Remarks	Overview
BGM adapter	MB2146-09A-E	For F ² MC-8FX family USB connection (USB bus power) Includes : USB cable (1.8 m)	
MCU board	MB2146-301A-E	For 3 V products Built-in MB95FV100D-101 (3 V type) For the LCDC division resistance type	
	MB2146-303A-E	For 5 V products Built-in MB95FV100D-103 (5 V type)	
Header board LQFP-48P (0.5 mm pitch, □ 7 × 7 mm)	MB2146-210	Products : MB95110B series Package code: FPT-48P-M26 Includes : NQPACK048SD * × 1, HQPACK048SD * × 1	
Header board LQFP-64P (0.5 mm pitch, □ 10 × 10 mm)	MB2146-220	Products : MB95110B/AM series Package code: FPT-64P-M03 Includes : NQPACK064SD * × 1, HQPACK064SD * × 1	
Header board LQFP-64P (0.65 mm pitch, □ 12 × 12 mm)	MB2146-221	Products : MB95110B/AM series Package code: FPT-64P-M09 Includes : NQPACK064SB * × 1, HQPACK064SB140 * × 1	
Header board LQFP-100P (0.5 mm pitch, □ 14 × 14 mm)	MB2146-250	Products : MB95120/MB series Package code: FPT-100P-M05 FPT-100P-M24 Includes : NQPACK100SD * × 1, HQPACK100SD * × 1	
Header board QFP-100P (0.65 mm pitch, □ 14 × 20 mm)	MB2146-251	Products : MB95120/MB series Package code: FPT-100P-M06 FPT-100P-M23 Includes : NQPACK100RB179 * × 1, HQPACK100RB179 * × 1	
Header board LQFP-52P (0.65 mm pitch, □ 10 × 10 mm)	MB2146-260	Products : MB95110B/M series Package code: FPT-52P-M01 Includes : NQPACK052SB * × 1, HQPACK052SB * × 1	
Header board/conversion board SOP-28P (1.27 mm pitch, □ 8.6 × 17.75 mm)	MB2146-270	Products : MB95130M series Package code: FPT-28P-M17 Includes : SSA-28YR1-M17 (Tokyo Eletech)	
Header board LQFP-32P (0.8 mm pitch, □ 7 × 7 mm)	MB2146-200	Products : MB95140 series Package code: FPT-32P-M21 Includes : NQPACK032SA * × 1, HQPACK032SA * × 1	

(Continued)

8-bit Proprietary F²MC-8FX Family Support Tools

(Continued)

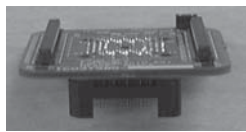
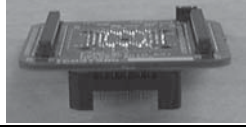
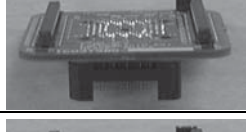
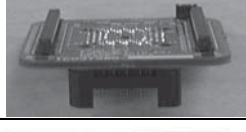
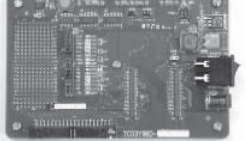
Name	Part number	Remarks	Overview
Header board LQFP-48P (0.5 mm pitch, □ 7 × 7 mm)	MB2146-213	Products : MB95150M series Package code: FPT-48P-M26 Includes : NQPACK048SD * × 1, HQPACK048SD * × 1	
Header board LQFP-52P (0.65 mm pitch, □ 10 × 10 mm)	MB2146-261	Products : MB95150M series Package code: FPT-52P-M01 Includes : NQPACK052SB * × 1, HQPACK052SB * × 1	
Header board LQFP-64P (0.5 mm pitch, □ 10 × 10 mm)	MB2146-222	Products : MB95160M series Package code: FPT-64P-M24 Includes : NQPACK064SD * × 1, HQPACK064SD * × 1	
Header board LQFP-64P (0.65 mm pitch, □ 12 × 12 mm)	MB2146-223	Products : MB95160M series Package code: FPT-64P-M23 Includes : NQPACK064SB * × 1, HQPACK064SB * × 1	
Evaluation board	MB2146-401	For F ² MC-8FX family - Operating power supply voltage: 5 V or 3.3 V (selectable) - Function of LED lightning for output port (16 LED) - Locating signal check pin to all terminals - Includes: AC adapter	

*: The header board requires NQPACK.

Contact for details:

- USA: OESS Co. San Jose Office TEL(408)437-1582
- Europe Germany: OESS GmbH TEL(06106)2857890
- Tokyo Eletech Co, Ltd. TEL(81)3-3820-7141

■ Emulator specification for F²MC-8FX

Emulator series	MB2146 series emulator
Main unit	MB2146-09A-E
Target microcontroller	F ² MC-8FX Family
Operating power supply voltage of micro-controller	2.7 V to 5.5 V
Operating frequency of microcontroller	External : 32 kHz to 21.0 MHz Internal : 16 kHz to 10.5 MHz
Dimensions, weight	W 40 × D 100 × H 25 mm (A projection part and a cable part remove.) Interface cable length : 100 mm 55 g
Host interface (download speed)	USB2.0 : 12 Mbps (125 Kbps@4 MHz or more)
Power supply	USB bus power
Execution control function	Continuous execution Step execution
Instruction execution break function	256 points
Data break function	2 points
Execution time measurement function	Yes
Internal ROM emulation memory function	Evaluation device Flash memory size (60 KB)
Trace function	Instruction trace (max. 16 branches)
Sequential Break function	2 levels (only code)
RAM monitoring function	Yes

■ F²MC-8FX starter kit

As the F²MC-8FX starter kit consists of a BGM adapter, an MCU board, an evaluation board, and SOFTUNE V3 (trial version), it is best suited for evaluating the performance and functions of microcontrollers and for verifying its operations before incorporating it into your system. By additionally purchasing a header board, you can use the existing BGM adapter and MCU board to evaluate your system.

System configuration

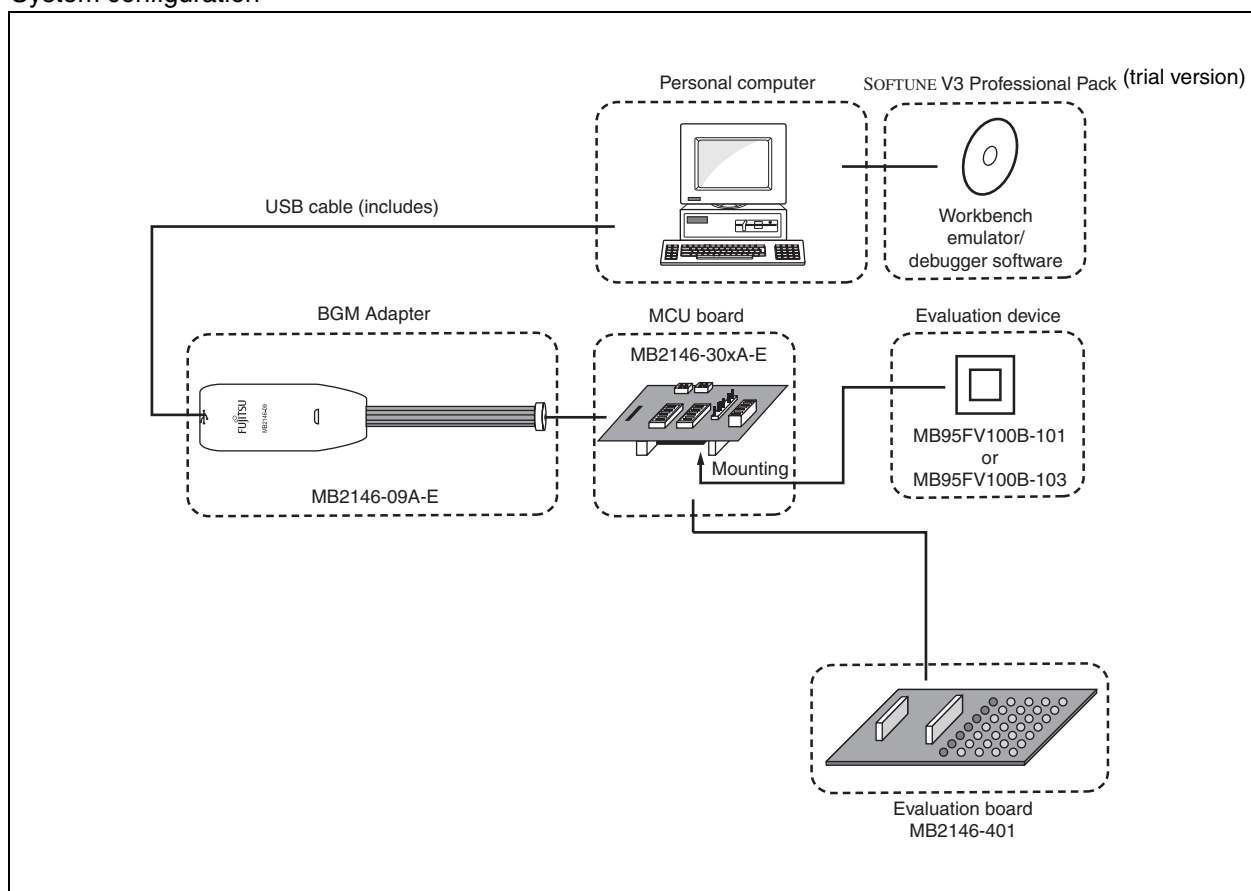

Product configuration

Product name	Part number	Product configuration
F ² MC-8FX starter kit (3 V)	MB2146-401-01A	BGM Adapter (MB2146-09A-E) 3 V edition MCU board (MB2146-301A-E) Evaluation board (MB2146-401) SOFTUNE V3 Professional Pack (trial version) Setup Guide
F ² MC-8FX starter kit (5 V)	MB2146-401-03A	BGM Adapter (MB2146-09A-E) 5 V edition MCU board (MB2146-303A-E) Evaluation board (MB2146-401) SOFTUNE V3 Professional Pack (trial version) Setup Guide

8-bit Proprietary F²MC-8L/8FX Family Support Tools

■ Adaptor Socket for Flash Microcomputer

5V-product

Flash Microcontrollers	Package (lead pitch, Body size) (mm)	Package code	Flash Support Group, Inc.
			AF9708 AF9709/B AF9710 AF9723
MB95F108AM *	LQFP-64P (0.5mm, 10mm × 10mm)	FPT-64P-M03	TEF110-108F35AP
	LQFP-64P (0.65mm, 12mm × 12mm)	FPT-64P-M09	TEF110-108F36AP
MB95F118M	LQFP-52P (0.65 mm, 10 mm × 10 mm)	FPT-52P-M01	TEF110-95118PMC
MB95F128MB	LQFP-100P (0.5 mm, 14 mm × 14 mm)	FPT-100P-M05	TEF110-95F128HSPFV
	QFP-100P (0.65 mm, 14 mm × 20 mm)	FPT-100P-M06	TEF110-95F128HSPF
MB95F136M	SOP-28P (1.27 mm, 8.6 mm × 17.75 mm)	FPT-28P-M17	TEF110-95F136HSPF
MB95F156M	LQFP-48P (0.5 mm, 7 mm × 7 mm)	FPT-48P-M26	TEF110-95F156HPFV
	LQFP-52P (0.65 mm, 10 mm × 10 mm)	FPT-52P-M01	TEF110-95F156HPMC
MB95F168M	LQFP-64P (0.5 mm, 10 mm × 10 mm)	FPT-64P-M24	TEF110-95F168HPMC1
	LQFP-64P (0.65 mm, 12 mm × 12 mm)	FPT-64P-M23	TEF110-95F168HPMC

*: Under development

3V-product

Flash Microcontrollers	Package (lead pitch, Body size) (mm)	Package code	Flash Support Group, Inc.
			AF9708 AF9709/B AF9710 AF9723
MB95F108B *	LQFP-64P (0.5mm, 10 mm × 10 mm)	FPT-64P-M03	TEF110-108F35AP
	LQFP-64P (0.65mm, 12 mm × 12 mm)	FPT-64P-M09	TEF110-108F36AP
MB95F118B *	LQFP-48P (0.5mm, 7 mm × 7 mm)	FPT-48P-M26	TEF110-118F37AP
	BCC-48P (0.5mm, 7 mm × 7 mm)	LCC-48P-M09	TEF110-118F41AP
MB95F128D	LQFP-100P (0.5mm, 14 mm × 14 mm)	FPT-100P-M24	TEF110-95F128HSPFV
	QFP-100P (0.65mm, 14 mm × 20 mm)	FPT-100P-M23	TEF110-95F128HSPF
MB95F146	LQFP-32P (0.8 mm, 7 mm × 7 mm)	FPT-32P-M21	TEF110-95F146

*: Under development

■ Parallel Programmer for Flash Microcontroller

The parallel programmer in Flash memory of the F²MC-8FX family is supported as the following programmer.

Flash Support Group, Inc.

URL: <http://www.j-fsg.co.jp/e/top.html>

- **Flash Programmer**

AF9708, AF9709/B: 3 V-products, 5 V-products.



AF9708



AF9709



AF9710

- **Gang programmer**

AF9723/AF9845: 3 V-products, 5 V-products

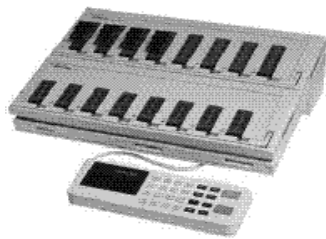

AF9723



AF9845

16-bit Proprietary F²MC-16LX Family Features

F²MC-16LX Family Features

- F²MC-16LX family is a high-performance 16-bit microcomputer having the upward compatibility with the F²MC-16L family.
- Supporting 16-Mbyte memory space.

Memory space

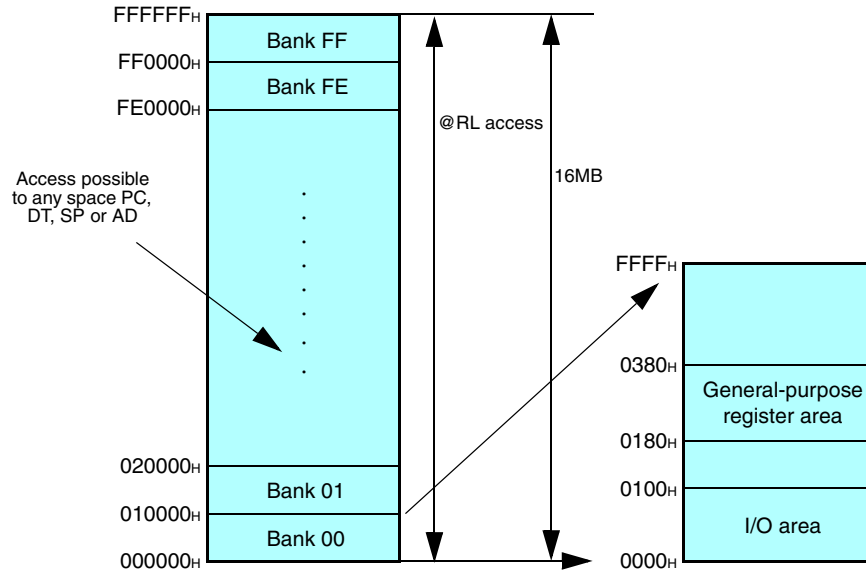

Registers

Dedicated registers

General-purpose registers: 10 × 16-bit per bank, 32 banks Max.

Dedicated registers

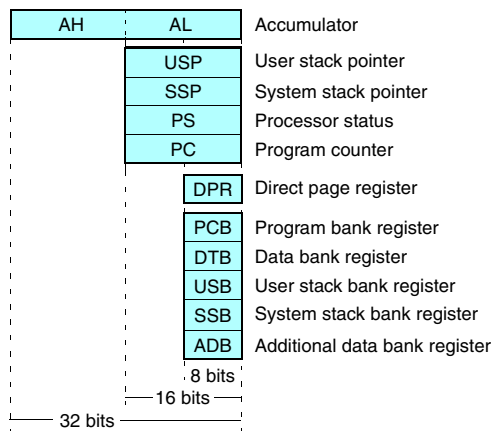

General-purpose registers

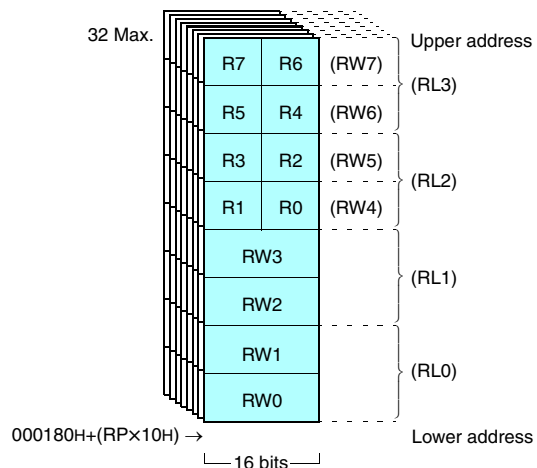

- Clock multiplier circuit (×1/2, ×2, ×3, and ×4) to protect your surrounding environment
Reducing the radiation interference
High-speed operation using the inexpensive low-speed oscillator (external 4 MHz; internal 16 MHz max.)
- Power management capabilities to contribute to the conservation of energy:
STOP, SLEEP, subclock, hardware standby
- AL 2 layers 0.5 μm (reducing the chip footprint)
- Low-voltage, low-power voltage dissipation
Supporting large memory (up to 256 Kbytes for ROM; up to 10 Kbytes for RAM)
- Power dissipation reduced by 60% as compared to the earlier product (5 V compatible product)

16-bit Proprietary F²MC-16LX Family Features

- **Reduced power dissipation (5 V compatible products)**

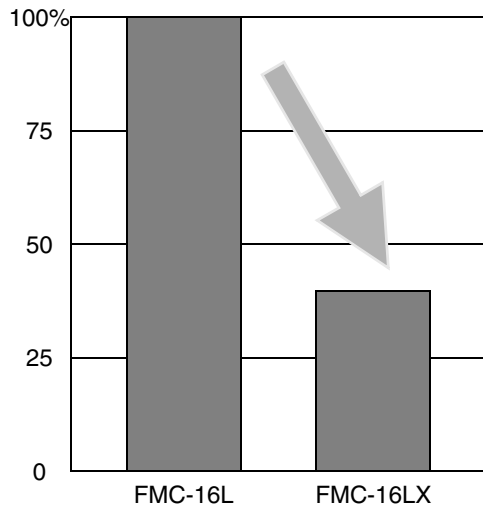

- Noise protection
 - Adoptation of multiplier circuit
 - Circuit optimization
 - Built-in noise filters for all pins
- Bus control
 - Bus sizing function: 8-bit or 16-bit bus width selectable
 - Software switching between non-multibus and multibus (device)
 - Supporting 8 ch. chip select (device)
- Built-in extended intelligent I/O service function (simple DMA function)
- Program patch processing function
 - Avoiding bugs by applying patches on a masked ROM
- Addition of signed multiplication and division instruction
- High-speed interrupt transition
 - High-speed transition achieved at the time of multiple interrupts
 - Expansion achieved to low-voltage and high-speed operation
 - 5.0 V: Minimum machine clock of 62.5 ns/16 MHz
 - 2.2 V: Minimum machine clock of 100 ns/10 MHz

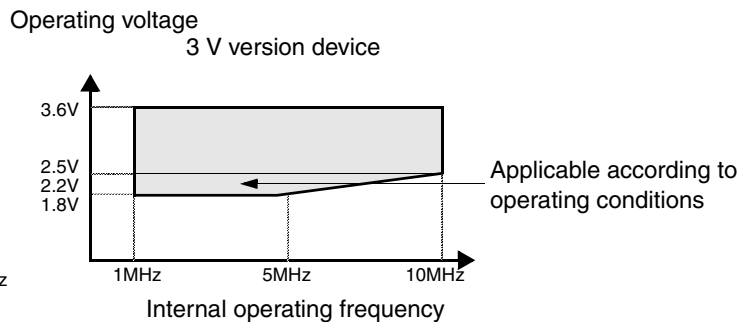
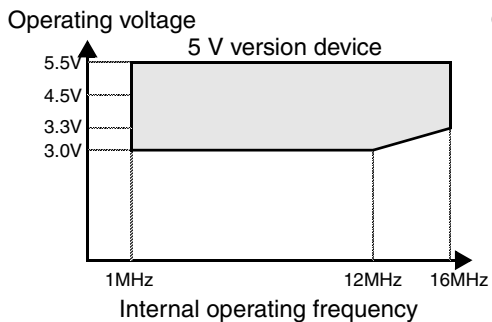

■ Main Addressing Modes (Can be used by transfer and arithmetic instructions)

- Bit addressing
Direct bit: I/O area (2Kbits) + area inside DPR page (2Kbits)
Any bit within 64 Kbytes may be specified.
- Indirect addressing
@RWi, @RWi+, @RWi+disp16, @RLi+disp8, @RWj+disp8 (i = 0 to 3), (j = 0 to 7)
@RW0+RW7
@RW1+RW7
@PC+disp16
@A
- Direct addressing
R0 to R7, RW0 to RW7, RL0 to RL3
dir, addr16, io

■ Super Accumulator

- 32-bit accumulator using AH:AL (16 bits:16 bits) as a pair.
- Data precision verification function

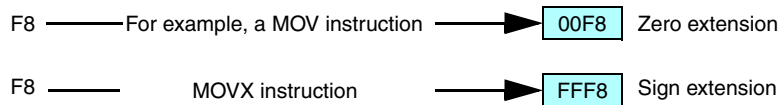

- Data keep function (available for data types of 16-bit word length and less)

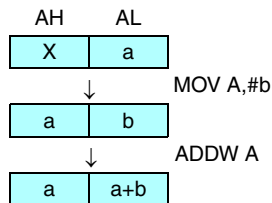

■ Fields for Product Expansion

Applicable to the following fields:

- Digital AV system→ (Serial communication enhancement, large size)
- Mobile equipment system→ (Low-power dissipation)
- File-related system→ (Signal processing enhancement)
- Network system→ (Telecommunication macro enhancement)

16-bit Proprietary F²MC-16LX/FX Family Product Range

F²MC-16LX Family Product Range

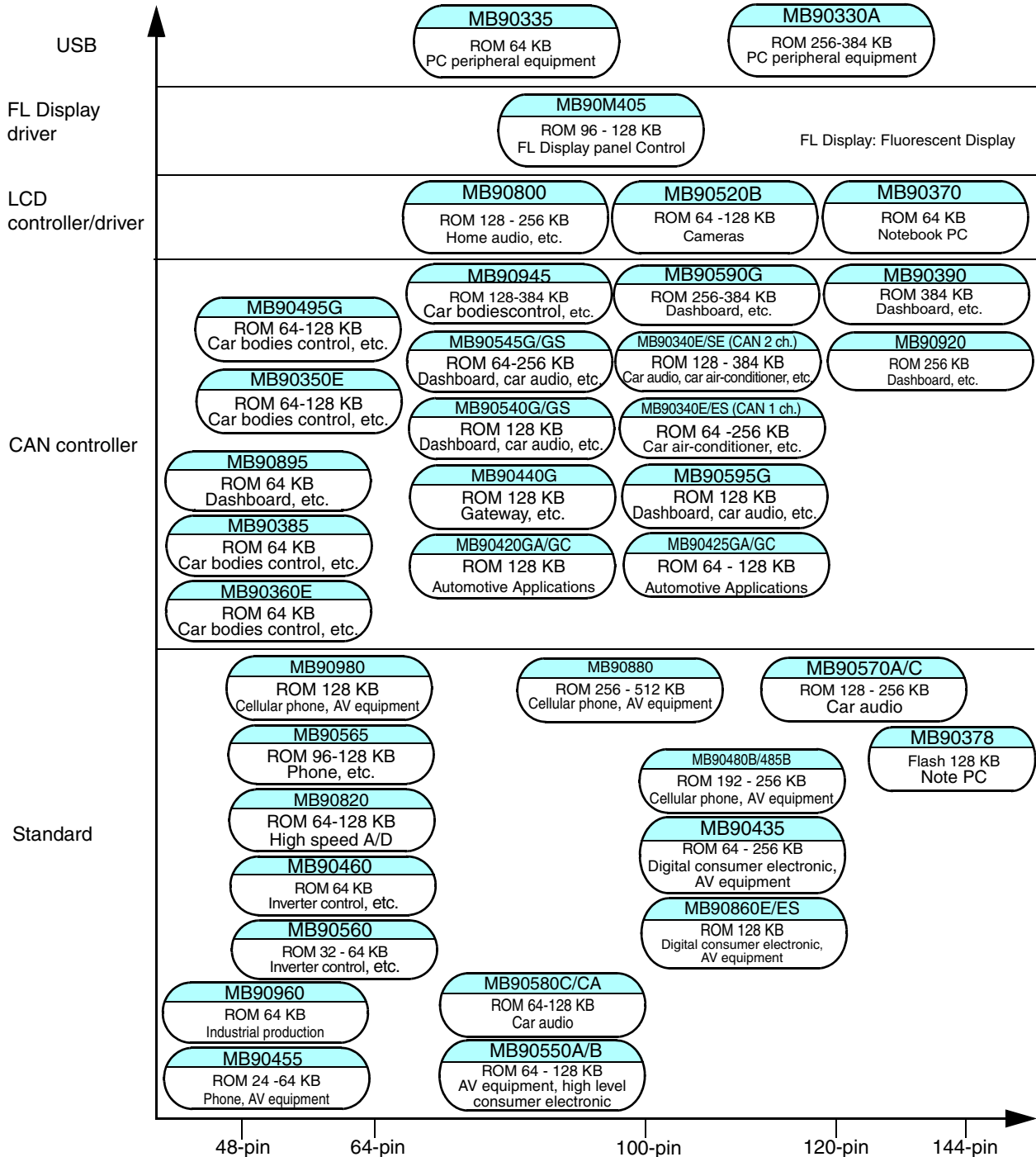

F²MC-16FX Family Product Range

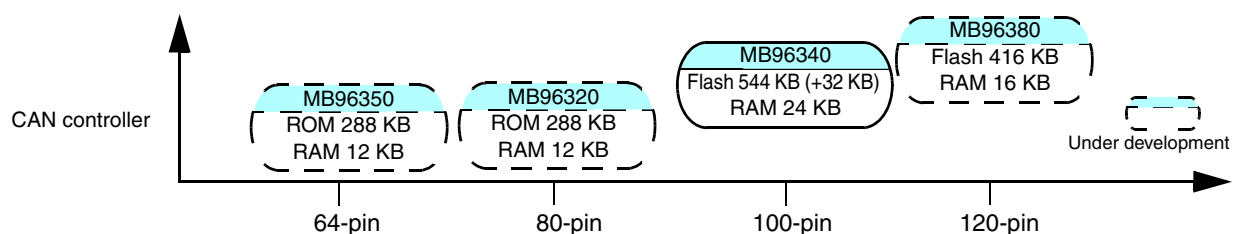

F²MC-16LX/FX
Family

16-bit Proprietary F²MC-16LX Family Standard Products

F²MC-16LX Family Standard Products

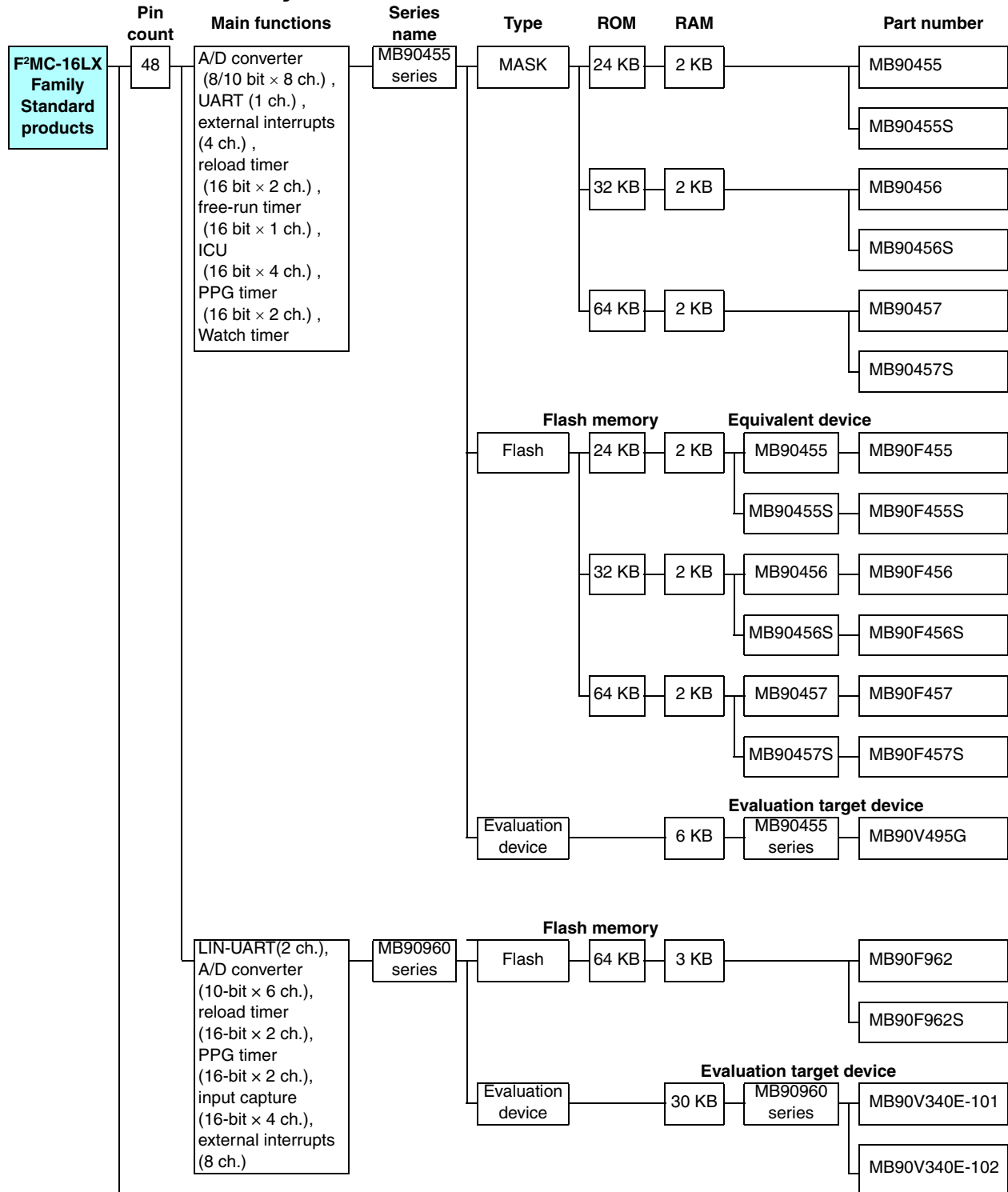

(Continued)

16-bit Proprietary F²MC-16LX Family Standard Products

■ MB90455 series

For AV equipment, high level consumer electronic, industrial applications, etc.

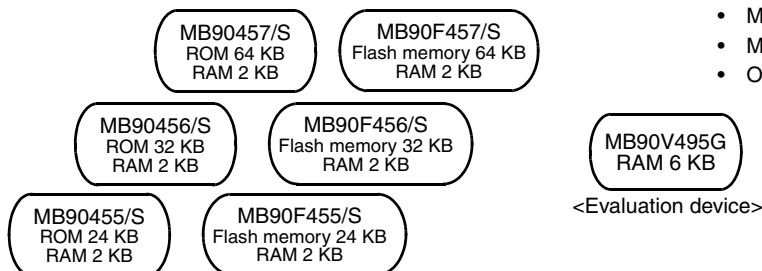

- Maximum clock frequency: 16 MHz (32.768 kHz)
- Minimum execution time: 62.5 ns (122.1 μs)
- Operating temperature range: -40°C to +105°C

Part number	Operating power supply voltage (V)	Package		Functions
		LQFP	PGA	
MB90455	+3.5 to +5.5	48P	-	I/O ports: 36 Max. (single clock) 34 Max. (dual clock) Timebase timer (WDT): 18-bit × 1 ch. Watch timer, PPG timer: 16-bit × 2 ch. (8-bit × 4 ch.) A/D converter: 8/10-bit × 8 ch. Real time I/O: 16-bit input capture unit (ICU) × 4 ch. 16-bit free-run timer × 1 ch. UART: 1 ch. For single clock: MB90455S/456S/457S/F455S/F456S/F457S For dual clock: MB90455/456/457/F455/F456/F457V495G External interrupts: 4 ch. Low-power consumption modes: Sleep, stop, time base timer, CPU intermittent operation, sub, watch mode
MB90455S		48P	-	
MB90456		48P	-	
MB90456S		48P	-	
MB90457		48P	-	
MB90457S		48P	-	
MB90F455		48P	-	
MB90F455S		48P	-	
MB90F456		48P	-	
MB90F456S		48P	-	
MB90F457		48P	-	
MB90F457S		48P	-	
MB90V495G		-	256C	

Packages: P - plastic, C - ceramic

■ MB90960 series

For industrial applications, etc.



- Maximum clock frequency: 24 MHz
- Minimum execution time: 62.5 ns
- Operating temperature range: -40°C to +105°C

Part number	Operating power supply voltage (V)	Package		Functions
		LQFP	PGA	
MB90F962 *2	+3.5 to +5.5	48P	-	I/O ports: 36 Max. (MB90F962S) 34 Max. (MB90F962) A/D converter: 8/10-bit × 16 ch. LIN-UART: 2 ch. Reload timer: 16-bit × 2 ch. PPG timer: 16-bit × 2 ch. Input capture unit (ICU) : 16-bit × 4 ch. Free-run timer: 16-bit × 1 ch. External interrupts: 8 ch. Low-power consumption modes: Sleep, stop, sub, sub sleep, watch, CPU intermittent operation, time base timer mode
MB90F962S *1		48P	-	
MB90V340E-101 *1	+4.5 to +5.5	-	299C	
MB90V340E-102 *2		-	299C	

Packages: P - plastic, C - ceramic

*1: Single clock, *2: Dual clock

16-bit Proprietary F²MC-16LX Family Standard Products

(Continued)

Pin count	Main functions	Series name	Type	ROM	RAM	Part number			
64	A/D converter (10-bit × 8ch.), UART(2ch.), external interrupts (8ch.), input capture (16-bit × 4ch.), output compare (16-bit × 6ch.), PPG timer (8-bit × 6ch.) reload timer (16-bit × 2ch.), free-run timer (16-bit × 1ch.), wave generator (1ch.)	MB90560 series	MASK	32 KB	1 KB	MB90561A			
				64 KB	2 KB	MB90562A			
			Flash memory	Flash	64 KB	2 KB	Equivalent device MB90560 series MB90F562B		
					Evaluation target device		Evaluation device 4 KB MB90560 series MB90V560		
			(Continued)	UART (2 ch.) , A/D converter (10-bit × 8ch.), external interrupts (8 ch.) , PWC timer (2 ch.) , PPG timer (16 bit × 3 ch.) , reload timer (16 bit × 2 ch.) , ICU (4 ch.) , OCU (6 ch.) , free-run timer (16 bit × 1 ch.) , multi-pulse generator	MB90460 series	MASK	64 KB	2 KB	MB90462
						Flash memory	Flash	64 KB	2 KB
Evaluation target device		Evaluation device 8 KB MB90460 series MB90V460							

(Continued)

(Continued)

16-bit Proprietary F²MC-16LX Family Standard Products

■ MB90560 series

For inverter control, etc.

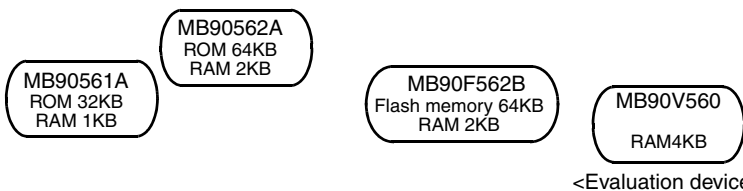

- Maximum internal clock frequency: 16 MHz
- Minimum execution time: 62.5 ns
- Operating temperature range: -40°C to +85°C

Part number	Operating power supply voltage (V)	Package				Functions
		QFP	LQFP	SH-DIP	PGA	
MB90561A	+3.0 to +5.5	64P (14 × 20 mm)	64P (12 × 12 mm)	64P	–	I/O ports: 51 Max. Timebase timer (WDT): 18-bit × 1 ch. UART: 2 ch. Analog section: 10-bit A/D converter × 8 ch. Real time I/O: 16-bit input capture unit (ICU) × 4 ch. 16-bit output compare unit (OCU) × 6 ch. 16-bit free-run timer × 1 ch. PPG timer: 8-bit × 6 ch. (16-bit × 3 ch.) Reload timer: 16bit × 2 ch. Wave generator: 1 ch. External interrupts: 8 ch. Low-power consumption modes: Sleep, stop, time base timer, CPU intermittent operation mode
MB90562A		64P (14 × 20 mm)	64P (12 × 12 mm)	64P	–	
MB90F562B	+4.5 to +5.5	64P (14 × 20 mm)	64P (12 × 12 mm)	64P	–	
MB90V560	+3.0 to +5.5	–	–	–	256C	

Packages: P - plastic, C - ceramic

■ MB90460 series

For inverter control, etc.

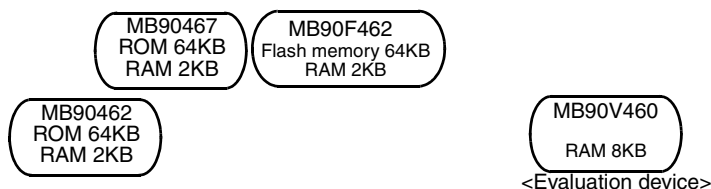

- Maximum internal clock frequency: 16 MHz
- Minimum execution time: 62.5 ns
- Operating temperature range: -40°C to +85°C

Part number	Operating power supply voltage (V)	Package				Functions
		QFP	LQFP	SH-DIP	PGA	
MB90462	+4.5 to +5.5	64P (14 × 20 mm)	64P (12 × 12 mm)	64P	–	I/O ports: 51 Max. Timebase timer (WDT): 18-bit × 1 ch. Analog section: 10-bit A/D converter × 8 ch. UART: 2 ch. PWC timer: 2 ch. (1 ch.: MB90467) Real time I/O: 16-bit input capture unit (ICU) × 4 ch. 16-bit output compare unit (OCU) × 6 ch. 16-bit free-run timer × 1 ch. PPG timer: 16 bit × 3 ch. (16 bit × 2 ch.: MB90467) Reload timer: 16 bit × 2 ch. Multi-pulse generator (not built in MB90467.) External interrupts: 8 ch. Low-power consumption modes: Sleep, stop, CPU intermittent operation mode, time base timer mode
MB90467		64P (14 × 20 mm)	64P (12 × 12 mm)	64P	–	
MB90F462		64P (14 × 20 mm)	64P (12 × 12 mm)	64P	–	
MB90V460		–	–	–	256C	

Packages: P - plastic, C - ceramic

16-bit Proprietary F²MC-16LX Family Standard Products

(Continued)	(Continued)								
Pin count	Main functions	Series name	Type	ROM	RAM		Part number		
64	UART(2 ch.), A/D converter (8/10-bit × 8 ch.), External interrupts (8 ch.), ICU (2 ch.), OCU (6 ch.), PPG timer (8-bit × 6 ch.) free-run timer (16 bit × 1 ch.), reload timer (16-bit × 2 ch.)	MB90565 series	MASK	96 KB	4 KB		MB90567		
				128 KB	4 KB		MB90568		
				Flash memory	128 KB	4 KB	Equivalent device	MB90565 series	MB90F568
				Evaluation device		4 KB	Evaluation target device	MB90565 series	MB90V560
	UART/SIO (1 ch.), SIO (2 ch.), A/D converter (8/10-bit × 8 ch.), external interrupts (8 ch.), ICU (16-bit × 2 ch.), OCU (16-bit × 4 ch.), PPG timer (8-bit × 4 ch.), U/D counter (8-bit × 2 ch.), reload timer (16-bit × 1 ch.), free-run timer (16 bit × 1 ch.), I ² C (1 ch.), PWC (2 ch.), μDMAC (16 ch.)	MB90980 series	MASK	128 KB	10 KB		MB90982		
				192 KB	12 KB	Equivalent device	MB90980 series	MB90F983	
				Flash memory	192 KB	12 KB	Equivalent device	MB90980 series	MB90F983
				Evaluation device		16 KB	Evaluation target device	MB90980 series	MB90V485B

(Continued)

16-bit Proprietary F²MC-16LX Family Standard Products

■ MB90565 series

For phone, etc.

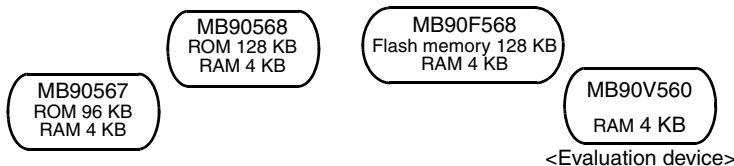

- Maximum internal clock frequency: 16 MHz
- Minimum execution time: 62.5 ns
- Operating temperature range: -40°C to +85°C

Part number	Operating power supply voltage (V)	Package			Functions
		QFP	LQFP	PGA	
MB90567	+2.7 to +3.6	64P (14 × 20 mm)	64P (12 × 12 mm)	–	I/O ports: 51 Max. Timebase timer (WDT): 18-bit × 1 ch. Reload timer: 16-bit × 2 ch. PPG timer: 8-bit × 6ch. (16-bit × 3ch.) Analog section: 8/10-bit A/D converter × 8ch. Real time I/O: 16-bit input capture unit (ICU) × 4ch. 16-bit output compare unit (OCU) × 4ch. 16-bit free-run timer × 1 ch. UART: 2 ch. External interrupts: 8 Low-power consumption modes: Sleep, hardware standby, time base timer mode, CPU intermittent operation
MB90568		64P (14 × 20 mm)	64P (12 × 12 mm)	–	
MB90F568		64P (14 × 20 mm)	64P (12 × 12 mm)	–	
MB90V560	+3.0 to +5.5	–	–	256C	

Packages: P - plastic, C - ceramic

■ MB90980 series

For Cellular phone, AV equipment, etc.



- Maximum internal clock frequency: 25 MHz
- Minimum execution time: 40 ns
- Operating temperature range: -40°C to +85°C

Part number	Operating power supply voltage (V)	Package		Functions
		LQFP (0.5 mm pitch)	PGA	
MB90982	+2.7 to +3.6	64P	–	I/O ports: 48 Max. Timebase timer (WDT): 18-bit × 1 ch. U/D counter: 8-bit × 2 ch. PPG timer: 8-bit × 4 ch. (16-bit × 2 ch.) SIO: 2 ch. Analog section: 8/10-bit A/D converter × 8ch. Real time I/O: 16-bit input capture unit (ICU) × 2 ch. 16-bit output compare unit (OCU) × 4 ch. 16-bit free-run timer × 1 ch. UART/SIO: 1 ch. I ² C bus interface: 1 ch. PWC: 2 ch. Reload timer: 16-bit × 1 ch. μDMAC: 16 ch. External interrupts: 8 ch. Low-power consumption modes: Sleep, stop, sub, watch, CPU intermittent operation, timebase timer mode
MB90F983		64P	–	
MB90V485B		–	299C	

Packages: P - plastic, C - ceramic

16-bit Proprietary F²MC-16LX Family Standard Products

(Continued)

Pin count	Main functions	Series name	Type	ROM	RAM	Part number				
80	A/D converter (8/10-bit × 16 ch.), D/A converter (8-bit × 2 ch.), Multifunction timer, UART(2 ch.), External interrupts (8 ch.), Reload timer (16-bit × 1 ch.), PWC timer (16-bit × 2 ch.), PPG timer (16-bit × 3 ch.)	MB90820 series	MASK	64 KB	4 KB	MB90822				
				128 KB	4 KB	MB90823				
			Flash memory	Equivalent device	Flash	64 KB	4 KB	MB90820 series	MB90F822A	
						128 KB	4 KB	MB90820 series	MB90F823A	
			Evaluation device	Evaluation target device	Evaluation device	16 KB	MB90820 series	MB90V820		
			100	A/D converter (10-bit × 8ch.), UART(1 ch.), I ² C bus interface (2ch.), external interrupts (8ch.), input capture (16-bit × 4ch.), output compare (16-bit × 4ch.), PPG timer (8-bit × 6ch.)	MB90550A/B series	MASK	64 KB	2 KB	MB90552A	
										MB90552B
							128 KB	4 KB	MB90553A	
									MB90553B	
						No ROM	2 KB	MB90T552A		
4 KB	MB90T553A									
OTPROM	Equivalent device	OTPROM				128 KB	4 KB	MB90550A/B series	MB90P553A	
Flash memory	Flash memory	Flash				128 KB	4 KB	MB90550A/B series	MB90F553A	
Evaluation device	Evaluation target device	Evaluation device				6 KB	MB90550A/B series	MB90V550A		

(Continued)

(Continued)

16-bit Proprietary F²MC-16LX Family Standard Products

■ MB90820 series

High speed A/D converter

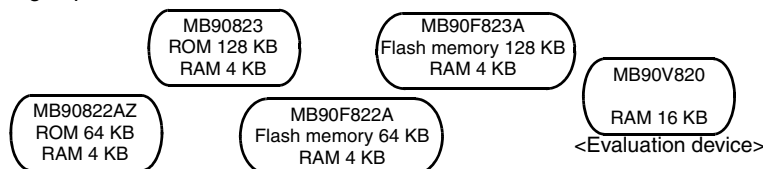

- Maximum internal clock frequency: 24 MHz
- Minimum execution time: 41.6 ns
- Operating temperature range: -40 °C to +85 °C

Part number	Operating power supply voltage (V)	Package				Functions
		LQFP (0.5 mm pitch)	LQFP (0.65 mm pitch)	QFP (0.8 mm pitch)	PGA	
MB90822	+3.5 to +5.5	80P	80P	80P	–	I/O ports: 66 Max. Analog section: 10-bit A/D converter × 16 ch. 8-bit D/A converter × 2 ch. Timebase timer (WDT): 18-bit × 1 ch. Multifunction timer: 16-bit input capture unit (ICU) × 4 ch. 16-bit output compare unit (OCU) × 6 ch. 16-bit free-run timer × 1 ch. 16-bit PPG timer × 1 ch. Waveform generation circuit PWC timer: 16-bit × 2 ch. PPG timer: 16-bit × 3 ch. UART: 2 ch. External interrupts: 8 ch. Low-power consumption modes: Sleep, stop, CPU intermittent operation, time base timer mode
MB90823		80P	80P	80P	–	
MB90F822A		80P	80P	80P	–	
MB90F823A		80P	80P	80P	–	
MB90V820	+4.5 to +5.5	–	–	–	299C	

Packages: P - plastic, C - ceramic

■ MB90550A/550B series

For AV equipment, high level consumer electronic, industrial applications, etc.

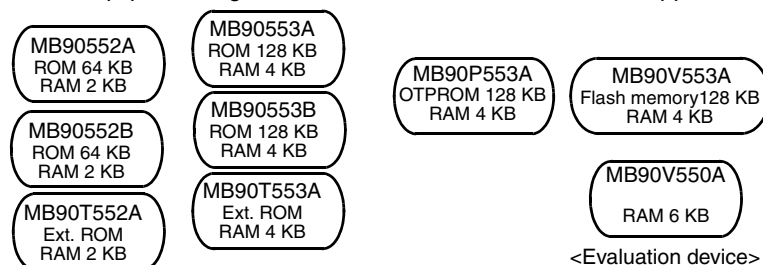

- Maximum internal clock frequency: 16 MHz
- Minimum execution time: 62.5 ns
- Operating temperature range: -40°C to +85°C

Part number	Operating power supply voltage (V)	Package			Functions
		QFP	LQFP	PGA	
MB90552A	+3.5 to +5.5	100P	100P	–	I/O ports: 83 Max. Timebase timer (WDT): 18-bit × 1 ch. UART: 1 ch. SIO: 1 ch. I ² C bus interface: 2 ch. Analog section: 10-bit A/D converter × 8 ch. Real time I/O: 16-bit input capture unit (ICU) × 4 ch. 16-bit output compare unit (OCU) × 4 ch. 16-bit free-run timer × 1 ch. PPG timer: 8-bit × 6 ch. (16-bit × 3 ch.) Reload timer : 16-bit × 2 ch. External interrupts: 8 Low-power consumption modes: Sleep, time base timer, stop, CPU intermittent operation
MB90552B		100P	100P	–	
MB90T552A		100P	100P	–	
MB90553A		100P	100P	–	
MB90553B		100P	100P	–	
MB90T553A		100P	100P	–	
MB90P553A	+4.5 to +5.5	100P	100P	–	
MB90F553A		100P	100P	–	
MB90V550A		–	–	256C	

Packages: P - plastic, C - ceramic

16-bit Proprietary F²MC-16LX Family Standard Products

(Continued)	(Continued)	(Continued)	(Continued)	(Continued)	(Continued)	(Continued)	(Continued)			
Pin count	Main functions	Series name	Type	ROM	RAM	Part number				
100	A/D converter (10-bit × 24 ch.), UART for LIN (4 ch.), OCU (16-bit × 8 ch.), ICU (16-bit × 8 ch.), reload timer (16-bit × 4 ch.), PPG timer (16-bit × 8 ch.), 16-bit × 1 ch), external interrupts (16 ch.), WDT	MB90860E/ ES series	MASK	128 KB	6 KB	MB90867E				
						MB90867ES				
			Flash memory		Equivalent device					
			Flash	128 KB	6 KB	MB90867E	MB90F867E			
					MB90867ES	MB90F867ES				
			Evaluation target device							
			Evaluation device		30 KB	MB90860E series	MB90V340E-102			
						MB90860ES series	MB90V340E-101			
				A/D converter (10-bit × 8ch.), D/A converter (8-bit × 2ch.), UART (5ch.), external interrupts (8ch.), input capture (16-bit × 4ch.), output compare (16-bit × 4ch.), PPG timer (8-bit × 2ch.), reload timer (16-bit × 3ch.), free-run timer (16-bit × 1ch.), PWC timer (16-bit × 1ch.), IE bus	MB90580C /CA series	MASK	64 KB	4 KB	MB90587C	
									MB90587CA	
	128 KB	6 KB				MB90583C				
						MB90583CA				
Flash memory		Equivalent device								
Flash	128 KB	6 KB				MB90583C	MB90F583C			
						MB90583CA	MB90F583CA			
	256 KB	6 KB				MB90F584C				
						MB90F584CA				
Evaluation target device										
Evaluation device		6 BK	MB90580 series	MB90V580B						

16-bit Proprietary F²MC-16LX Family Standard Products

■ MB90860E/860ES series

For Digital consumer electronic, AV equipment, etc.



- Maximum internal clock frequency: 24 MHz (32.768 kHz)
- Minimum execution time: 42.0 ns (122.1 μs)
- Operating temperature range: -40°C+105°C

Part number	Operating power supply voltage (V)	Package			Functions
		LQFP	QFP	PGA	
MB90867E	+3.5 to +5.5	100P	100P	–	I/O ports: 82 Max. (MB90867ES/F867ES: Single clock) 80 Max. (MB90867E/F867E: Dual clock) Timebase timer (WDT): 18-bit × 1 ch. PPG timer: 8-bit × 16 ch. (16-bit × 8 ch.) Analog section: 10-bit A/D converter × 24 ch. Real time I/O: 16-bit input capture unit (ICU) × 8 ch. 16-bit output compare unit (OCU) × 8 ch. 16-bit free-run timer × 2 ch. UART for LIN : 4 ch. I ² C: 2 ch. Reload timer: 116 bit × 4 ch External interrupts: 16 ch. Low-power consumption modes: Sleep, stop, watch, sub, time base timer, CPU intermittent operation mode
MB90867ES		100P	100P	–	
MB90F867E		100P	100P	–	
MB90F867ES		100P	100P	–	
MB90V340E-101	+4.5 to +5.5	–	–	299C	
MB90V340E-102		–	–	299C	

Packages: P - plastic

■ MB90580C/580CA series

For car audio, etc.

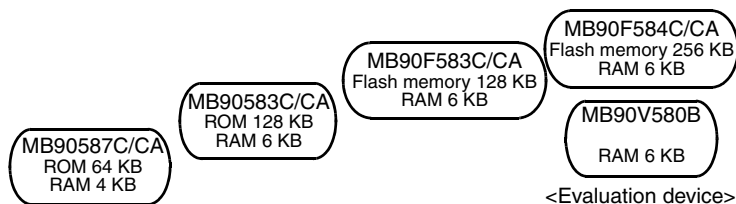

- Maximum internal clock frequency: 16 MHz (32.768 kHz)
- Minimum execution time: 62.5 ns (122.1 μs)
- Operating temperature range: -40°C to +85°C

Part number	Operating power supply voltage (V)	Package			Functions
		QFP	LQFP	PGA	
MB90583C	+3.0 to +5.5	100P	100P	–	I/O ports: 77 Max. Timebase timer (WDT): 18-bit × 1 ch. UART: 5 ch. Analog section: 10-bit A/D converter × 8 ch. 8-bit D/A converter × 2 ch. Real time I/O: 16-bit input capture unit (ICU) × 4 ch. 16-bit output compare unit (OCU) × 2 ch. 16-bit free-run timer × 1 ch. PPG timer: 8-bit × 2 ch. (16-bit × 1 ch.) PWC timer: 16-bit × 1 ch. Reload timer: 16-bit × 3 ch. IE bus (MB90583C/CA, MB90F583C/CA, MB90V580B) For single clock: MB90583C/587C/F583C/F584C/V580B For dual clock: MB90583CA/587CA/F583CA/F584CA/V580B External interrupts: 8 Low-power consumption modes: Sleep, stop, watch, sub, time base timer, CPU intermittent operation mode
MB90583CA		100P	100P	–	
MB90587C		100P	100P	–	
MB90587CA		100P	100P	–	
MB90F583C	+4.5 to +5.5	100P	100P	–	
MB90F583CA		100P	100P	–	
MB90F584C		100P	100P	–	
MB90F584CA		100P	100P	–	
MB90V580B	+3.0 to +5.5	–	–	256C	

Packages: P - plastic, C - ceramic

16-bit Proprietary F²MC-16LX Family Standard Products

(Continued)	(Continued)							
Pin count	Main functions	Series name	Type	ROM	RAM	Part number		
100	A/D converter (8/10 bit × 8 ch.), UART (2 ch.), SIO (1 ch.), external interrupts (8 ch.), reload timer (16 bit × 2 ch.), free-run timer (16 bit × 1 ch.), ICU (16 bit × 8 ch.), OCU (16 bit × 4 ch.), PPG timer (16 bit × 4 ch.)	MB90435 series	MASK	64 KB	2 KB	MB90437L		
						MB90437LS		
				128 KB	4 KB	MB90438L		
							MB90438LS	
			256 KB	6 KB	MB90439			
					MB90439S			
			Flash memory		Equivalent device			
		Flash	128 KB	4 KB	MB90437L MB90438L	MB90F438L		
					MB90437LS MB90438LS	MB90F438LS		
			256 KB	6 KB	MB90439	MB90F439		
					MB90439S	MB90F439S		
			Evaluation device	8 KB	MB90435 series	MB90V540G		
(Continued)	(Continued)							

16-bit Proprietary F²MC-16LX Family Standard Products

■ MB90435 series

For Digital consumer electronic, AV equipment, etc.

MB90439/S
ROM 256 KB
RAM 6 KB

MB90F439/S
Flash memory 256 KB
RAM 6 KB

MB90438L/S
ROM 128 KB
RAM 4 KB

MB90F438L/S
Flash memory 128 KB
RAM 4 KB

MB90V540G
RAM 8 KB

<Evaluation device>

MB90437L/S
ROM 64 KB
RAM 2 KB

- Maximum clock frequency: 16 MHz (32.768 kHz)
- Minimum execution time: 62.5 ns (122.1 μs)
- Operating temperature range: -40°C to +105°C

Part number	Operating power supply voltage (V)	Package			Functions
		LQFP	QFP	PGA	
MB90437L *2	+3.5 to +5.5	100P	100P	–	I/O ports: 80 Max. Timebase timer (WDT): 18-bit × 1 ch. 8/16 bit PPG timer: 4 ch. SIO : 1 ch A/D converter: 8/10-bit × 8 ch. Real time I/O: 16-bit input capture unit (ICU) × 8 ch. 16-bit output compare (OCU) × 4 ch. 16-bit free-run timer × 1 ch. UART: 2 ch. Reload timer : 16-bit × 2 ch. For Single clock: MB90437LS/438LS/439S/F438LS/F439S For Dual clocks: MB90437L/438L/439/F438L/F439/V540G External interrupts: 8 ch. Low-power consumption modes: Sleep, stop, time base timer, CPU intermittent operation , sub, watch mode
MB90437LS *1		100P	100P	–	
MB90438L *2		100P	100P	–	
MB90438LS *1		100P	100P	–	
MB90439 *2	+4.5 to +5.5	100P	100P	–	
MB90439S *1		100P	100P	–	
MB90F438L *2	+3.5 to +5.5	100P	100P	–	
MB90F438LS *1		100P	100P	–	
MB90F439 *2	+4.5 to +5.5	100P	100P	–	
MB90F439S *1		100P	100P	–	
MB90V540G *2		–	–	256C	

Packages: P - plastic, C - ceramic

*1: Single clock

*2: Dual clock

16-bit Proprietary F²MC-16LX Family Standard Products

(Continued)	(Continued)										
Pin count	Main functions	Series name	Type	ROM	RAM	Part number					
100	UART (1 ch.), SIO (2 ch.), A/D converter (8/10-bit × 8 ch.), μDMAC (16 ch.), external interrupts (8 ch.), input capture (16-bit × 2 ch.), output compare (16-bit × 6 ch.), PPG timer (8-bit × 6 ch.), up/down counter (8-bit × 2 ch.), reload timer (16-bit × 1 ch.), free-run timer (16-bit × 1 ch.)	MB90480B series	Flash	192 KB	4 KB	MB90F481B					
				256 KB	6 KB	MB90F482B					
			Evaluation device	16 KB	MB90480B series	MB90V480B					
					Evaluation target device						
			UART (1 ch.), SIO(2 ch.), A/D converter (8/10-bit × 8 ch.), μDMAC (16 ch.), external interrupts (8 ch.), input capture (16-bit × 2 ch.), output compare (16-bit × 6 ch.), PPG timer (8-bit × 6 ch.), up/down counter (8-bit × 2 ch.), reload timer (16-bit × 1 ch.), free-run timer (1 ch.), I ² C bus interface (1 ch.), PWC (3 ch.), μPG (1 ch.)	MB90485B series	MASK	192 KB	10 KB	MB90487B			
						256 KB	10 KB	MB90488B			
						16 KB		MB90483C			
							Flash memory				
				Flash	256 KB	10 KB	MB90F488B				
					384 KB	24 KB	MB90F489B				
				Evaluation target device							
Evaluation device	16 KB			MB90485B series	MB90V485B						

16-bit Proprietary F²MC-16LX Family Standard Products

■ MB90480B series

For AV equipment, high level consumer electronic, industrial applications, etc.

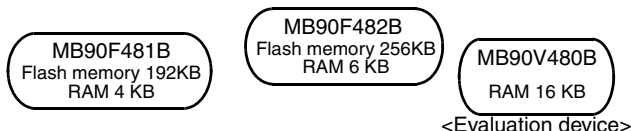

- Maximum internal clock frequency: 25 MHz(32.768 kHz)
- Minimum execution time: 40 ns(125 μs)
- Operating temperature range: -40°C to +85°C

Part number	Operating power supply voltage (V)	Package			Functions
		QFP	LQFP	PGA	
MB90F481B	+2.7 to +3.6	100P	100P	-	I/O ports: 84 Max. Timebase timer (WDT): 18 bit × 1 ch. Up/down counter: 8 bit × 2 ch. (16bit × 1 ch.) PPG timer: 8 bit × 6 ch. (16bit × 3 ch.) SIO: 2 ch. Analog section: 8/10bit A / D converter × 8 ch. Real time I/O: 16-bit input capture unit (ICU) × 2 ch 16-bit output compare unit (OCU) × 6 ch 16-bit free-run timer × 1 ch. UART: 1 ch. Reload timer: 16 bit × 1 ch. μDMAC : 16 ch. External interrupts: 8 ch. Low-power consumption modes: Sleep, stop (hardware), watch sub, CPU intermittent operation, time base timer mode
MB90F482B		100P	100P	-	
MB90V480B		-	-	299C	

Packages: P - plastic, C - ceramic

■ MB90485B series

For AV equipment, high level consumer electronic, industrial applications, etc.

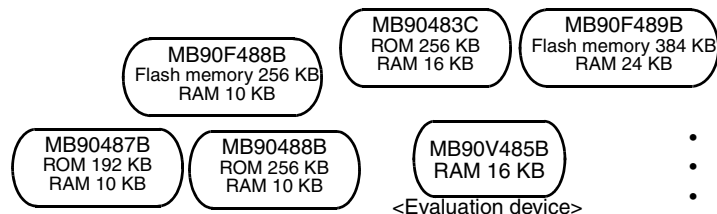

- Maximum internal clock frequency: 25 MHz (32.768 kHz)
- Minimum execution time: 40 ns (125 μs)
- Operating temperature range: -40°C to +85°C

Part number	Operating power supply voltage (V)	Package			Functions
		QFP	LQFP	PGA	
MB90483C	+2.7 to +3.6	100P	100P	-	I/O ports: 84 Max. Timebase timer (WDT): 18-bit × 1 ch. Up/down counter: 8-bit × 2ch. PPG timer: 8-bit × 6 ch. (16-bit × 3 ch.) SIO: 2 ch. Analog section: 8/10-bit A/D converter × 8 ch. Real time I/O: 16-bit input capture unit (ICU) × 2 ch. 16-bit output compare unit (OCU) × 6 ch. 16-bit free-run timer × 1 ch. UART: 1 ch. I ² C bus interface: 1 ch. μPG: 1 ch. PWC: 3 ch. Reload timer μDMAC: 16 ch. External interrupts: 8 Low-power consumption modes: Sleep, stop, sub, time base timer, watch, CPU intermittent operation mode
MB90487B		100P	100P	-	
MB90488B		100P	100P	-	
MB90F488B		100P	100P	-	
MB90F489B		100P	100P	-	
MB90V485B		-	-	299C	

Packages: P - plastic, C - ceramic

16-bit Proprietary F²MC-16LX Family Standard Products

(Continued)	(Continued)								
Pin count	Main functions	Series name	Type	ROM	RAM	Part number			
100	Multi function serial (UART/SIO/I ² C mode can be switched. 7 ch.) , A/D converter (8/10-bit × 20 ch.) , external interrupts (24 ch.) , input capture (16-bit × 2 ch.) , output compare (16-bit × 6 ch.) , free-run timer (16-bit × 1 ch.) PPG timer (16-bit × 8 ch.) , up/down counter (8-bit × 2 ch.) , base timer (reload timer/ PWC/PPG/PWM mode can be switched. 4 ch.) , μ DMAC (16 ch.)	MB90880 series	MASK	256 KB	16 KB	MB90882 **			
				384 KB	24 KB	MB90883 **			
				512 KB	30 KB	MB90884 **			
						Flash memory			
			Flash	256 KB	16 KB	MB90F882		MB90F882S	
				384 KB	24 KB	MB90F883A		MB90F883AS	
				512 KB	30 KB	MB90F884A		MB90F884AS	
						Evaluation target device			
			Evaluation device	30 KB	MB90880 series	MB90V880A-101		MB90V880A-102	

*: Under development
 **: Under planning

(Continued)

16-bit Proprietary F²MC-16LX Family Standard Products

■ MB90880 series

For AV equipment, high level consumer electronic, industrial applications, etc.

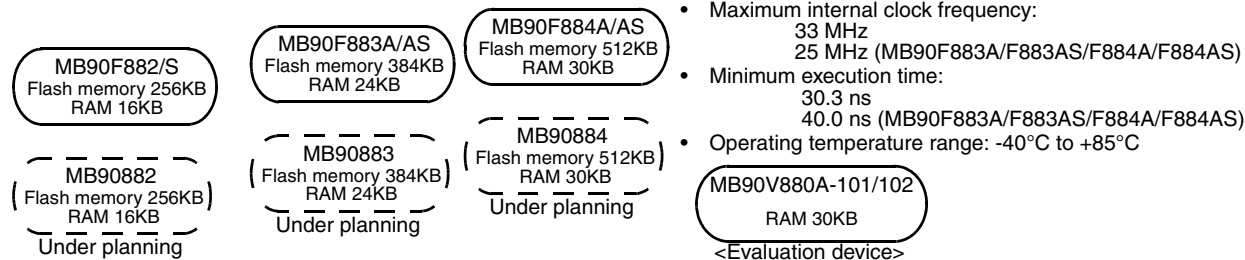

Part number	Operating power supply voltage (V)	Package		Functions
		QFP (0.65 mm pitch)	LQFP (0.5 mm pitch)	
○ MB90882	+2.7 to +3.6	100P	100P	I/O ports: 83 Max. (single clock) 81 Max. (dual clock) Timebase timer (WDT): 18 bit × 1 ch. Up/down counter: 8 bit × 2 ch. PPG timer: 16-bit × 8 ch. Multi function serial: 7 ch. (UART/SIO/I2C mode can be switched.) A/D converter: 8/10-bit × 20 ch. Real time I/O: 16-bit input capture unit (ICU) × 2 ch. 16-bit output compare unit (OCU) × 6 ch. 16-bit free-run timer × 1 ch. Base timer: 4 ch. (16-bit reroad timer/PWC/PPG/PWM mode can be switched.) External interrupts: 24 ch. μDMAC : 16 ch. Flash security (MB90F882/F882S) Mis-writing prevention function (MB90F882/F882S) Low-power consumption modes: Sleep, stop, sub, watch, CPU intermittent operation, time base timer mode
○ MB90883		100P	100P	
○ MB90884		100P	100P	
MB90F882 *2		100P	100P	
MB90F882S *1		100P	100P	
MB90F883A *2		100P	100P	
MB90F883AS *1		100P	100P	
MB90F884A *2		100P	100P	
MB90F884AS *1		100P	100P	
MB90V880A-101 *1		-	-	
MB90V880A-102 *2		-	-	

Packages: P - plastic, C - ceramic

○: Under planning

*1: Single clock

*2: Dual clock

16-bit Proprietary F²MC-16LX Family Standard Products

(Continued)

Pin count	Main functions	Series name	Type	ROM	RAM	Part number	
120	A/D converter (10-bit × 8ch.), D/A converter (8-bit × 2ch.), UART (2ch.), SIO(3ch.), external interrupts (8ch.), input capture (16-bit × 2ch.), output compare (16-bit × 4ch.), I ² C bus interface, PPG timer (8-bit × 2ch.), up/down counter (8-bit × 2ch.), free-run timer, timer (1ch.)	MB90570A/C series	MASK	128 KB	6 KB	MB90573	
				256 KB	10 KB	MB90574C	
			Flash memory		Equivalent device		
			Flash	256 KB	10 KB	MB90573/ 574C	MB90F574A
			Evaluation target device		Evaluation target device		
		Evaluation device		10 KB	MB90570A/C series	MB90V570A	
144	A/D converter (8/10-bit × 12 ch.) , D/A converter (8-bit × 2 ch.) , LCDC (9 seg × 4 com) , LPC interface, PS/2 interface, UART/SIO (3 ch.) , I2C (1 ch.) , multi address I ² C (1 ch.) , bridge circuit, external interrupts (24 ch.) , key on wake up (8 ch.) , 8/16-bit PPG timer (8-bit × 4 ch. or 16-bit × 2 ch.) , 16-bit PPG timer (16-bit × 3 ch.) , reload timer (16-bit × 6 ch.)	MB90378 series	Flash memory				
			Dual Flash	128 KB	6 KB	MB90F378	
			Evaluation target device		Evaluation target device		
		Evaluation device		16 KB	MB90378 series	MB90V378	

16-bit Proprietary F²MC-16LX Family Standard Products

■ MB90570A/570C series

For car audio

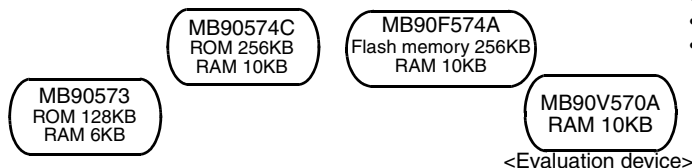

- Maximum internal clock frequency: 16 MHz (32.768 kHz)
- Minimum execution time: 62.5 ns (122.1 μs)
- Operating temperature range: -40°C to +85°C

Part number	Operating power supply voltage (V)	Package			Functions
		QFP	LQFP	PGA	
MB90573	+3.0 to +5.5	120P (14 × 14 mm)	120P	-	I/O ports: 97 Max. Timebase timer (WDT): 18-bit × 1 ch. UART: 2ch. Analog section: 10-bit A/D converter × 8 ch. 8-bit D/A converter × 2 ch. Real time I/O: 16-bit input capture unit (ICU) × 2 ch. 16-bit output compare unit (OCU) × 4 ch. 16-bit free-run timer × 1 ch. PPG timer: 8-bit × 2 ch. (16-bit × 1 ch.) I ² C bus interface Up/down counter: 8-bit × 2ch.(16-bit × 1 ch.) SIO: 3 ch. External interrupts: 8 Clock timer: 1 ch. Low-power consumption modes: Sleep, stop, sub, time base timer, watch, CPU intermittent operation mode
MB90574C		120P (14 × 14 mm)	120P (20 × 20 mm)	-	
MB90F574A	+4.5 to +5.5	120P (14 × 14 mm) (16 × 16 mm)	120P (20 × 20 mm)	-	
MB90V570A	+3.0 to +5.5	-	-	256C	

Packages: P - plastic, C - ceramic

■ MB90378 series

For note PC



- Maximum internal clock frequency: 16 MHz
- Minimum execution time: 62.5 ns
- Operating temperature range: -40 °C to +85 °C

Part number	Operating power supply voltage (V)	Package		Functions
		LQFP (0.4 mm pitch)	PGA	
MB90F378	+3.0 to +3.6	144P	-	I/O ports: 125 Max. LPC interface PS/2 interface I ² C bus interface : 1 ch. Multi address I ² C bus interface : 1 ch. Bridge circuit LCD controller/driver : 9 SEG × 4 COM Watch timer 8/16-bit PPG timer : 8-bit × 4 ch. or 16-bit × 2 ch. 16-bit PPG timer : 3 ch. 16-bit reload timer : 6 ch. Analog section : 8/10-bit A/D converter × 12 ch. 8-bit D/A converter × 2 ch. UART/SIO : 3 ch. External interrupts : 24 ch. Key on wake up : 8 ch. Timebase timer (WDT) : 18-bit × 1 ch. Low-power consumption modes : Sleep, stop, sub, watch, CPU intermittent operation, time base timer mode
MB90V378		-	256C	

Packages: P - plastic, C - ceramic

16-bit Proprietary F²MC-16LX Family CAN Controller Products

F²MC-16LX Family CAN Controller Products

	Pin count	Main functions	Series name	Type	ROM	RAM	Part number							
F ² MC-16LX Family CAN Controller Products	48	CAN interface (1 ch.), UART for LIN (2 ch), A/D converter (10 bit × 8 ch), Reload timer (16 bit × 2 ch), PPG timer (16 bit × 2 ch), ICU (16 bit × 4 ch), external interrupts (8 ch)	MB90360E series	MASK	64 KB	3 KB	MB90362E							
							MB90362TE							
							MB90362ES							
							MB90362TES							
							MB90367E							
							MB90367TE							
							MB90367ES							
							MB90367TES							
											Flash memory		Equivalent device	
										Flash	64 KB	3 KB	MB90360E series	MB90F362E
														MB90F362TE
														MB90F362ES
														MB90F362TES
														MB90F367E
														MB90F367TE
							MB90F367ES							
							MB90F367TES							
				Evaluation device		Evaluation target device								
			Evaluation device		30 KB	MB90360E series	MB90V340E-101							
							MB90V340E-102							
							MB90V340E-103							
							MB90V340E-104							

(Continued)

(Continued)

16-bit Proprietary F²MC-16LX Family CAN Controller Products

■ MB90360E series

For car bodies control, etc.

MB90362E/TE
MB90362ES/TES
ROM 64 KB
RAM 3 KB

MB90F362E/TE
MB90F362ES/TES
Flash memory 64 KB
RAM 3 KB

MB90367E/TE
MB90367ES/TES
ROM 64 KB
RAM 3 KB

MB90F367E/TE
MB90F367ES/TES
Flash memory 64 KB
RAM 3 KB

MB90V340E
RAM 30 KB
<Evaluation device>

- Maximum clock frequency: 24 MHz
- Minimum execution time : 41.6 ns
- Operating temperature range : -40 to +105 °C

Part number	Operating power supply voltage (V)	Package		Functions
		LQFP (0.5 mm pitch)	PGA	
MB90362E *2	+3.5 to +5.5	48P	–	I/O ports: 36 Max. (single clock) 34 Max. (dual clock) CAN interface : 1ch Timebase timer (WDT) : 18bit × 1ch Reload timer : 16bit × 2ch PPG timer : 8bit × 2ch or 16bit × 2ch 16bit input/output timer : input capture unit (ICU) × 4ch free-run timer × 1ch UART for LIN : 2ch A/D converter : 8/10bit × 16ch External interrupt : 8ch Clock monitoring function Low voltage/CPU operation detection reset (MB90362TE/362TES/367TE/367TES/F362TE/F362TES/F367TE/F367TES) Low-power consumption modes : Sleep, stop, sub, sub sleep, watch, CPU intermittent operation, time base timer mode
MB90362TE *2		48P	–	
MB90362ES *1		48P	–	
MB90362TES *1		48P	–	
MB90367E *2		48P	–	
MB90367TE *2		48P	–	
MB90367ES *1		48P	–	
MB90367TES *1		48P	–	
MB90F362E *2		48P	–	
MB90F362TE *2		48P	–	
MB90F362ES *1		48P	–	
MB90F362TES *1		48P	–	
MB90F367E *2		48P	–	
MB90F367TE *2		48P	–	
MB90F367ES *1		48P	–	
MB90F367TES *1	48P	–		
MB90V340E-101 *1	+4.5 to +5.5	–	299C	
MB90V340E-102 *2		–	299C	
MB90V340E-103 *1		–	299C	
MB90V340E-104 *2		–	299C	

Packages: P - plastic, C - ceramic

*1 : single clock, *2 : dual clock

16-bit Proprietary F²MC-16LX Family CAN Controller Products

(Continued)	Pin count	(Continued) Main functions	Series name	Type	ROM	RAM	Part number		
(Continued)	48	CAN interface (1ch.), UART (1 ch.), A/D converter (8/10-bit × 8ch.), external interrupts (4 ch.), free-run timer (16-bit × 1ch.), input capture (16-bit × 4ch.), 8/16-bit PPG timer (2 ch.), Watch timer, Reload timer (16-bit × 2ch.)	MB90385 series	MASK	64 KB	2 KB	MB90387		
								MB90387S	
				Flash memory		Equivalent device			
				Flash	64 KB	2 KB	MB90387	MB90F387	
								MB90F387S	
				Evaluation target device					
				Evaluation device		6 KB	MB90385 series	MB90V495G	
				Flash memory		Evaluation target device			
				Flash	64 KB	2 KB		MB90F897	
								MB90F897S	
			Evaluation target device						
			Evaluation device	6 KB	MB90890 series	MB90V495G			
		A/D converter (8/10-bit × 8 ch.), UART/SIO (2 ch.), CAN interface (1 ch.), external interrupts (4 ch.), ICU (16 bit × 4 ch.), PPG timer (8/16-bit × 2 ch.), Reload timer (16-bit × 2 ch.), WDT	MB90895 series	Flash	64 KB	2 KB	MB90F897		
							MB90F897S		
			Evaluation target device						
			Evaluation device	6 KB	MB90890 series	MB90V495G			

16-bit Proprietary F²MC-16LX Family CAN Controller Products

■ MB90385 series

For car bodies control, etc.



- Maximum clock frequency: 16 MHz (32.768 kHz)
- Minimum execution time: 62.5 ns (122.1 μs)
- Operating temperature range: -40°C to +105°C

Part number	Operating power supply voltage (V)	Package		Functions
		LQFP	PGA	
MB90387	+3.5 to +5.5	48P	-	I/O ports: 36 Max. (MB90387S/F387S) 34 Max. (MB90387/F387/V495G) CAN interface: 1ch. Timebase timer (WDT): 18-bit × 1 ch. Watch timer PPG timer: 16-bit × 2 ch. (8-bit × 4 ch.) A/D converter: 8/10-bit × 8 ch. Real time I/O: 16-bit input capture unit (ICU) × 4 ch. 16-bit free-run timer × 1 ch. UART: 1 ch. Reload timer: 16-bit × 2 ch. For single clock: MB90387S/F387S For dualclock: MB90387/F387/V495G External interrupts: 4ch. Low-power consumption modes: Sleep, stop, sub, watch, time base timer, CPU intermittent operation mode
MB90387S		48P	-	
MB90F387		48P	-	
MB90F387S		48P	-	
MB90V495G		-	256C	

Packages: P - plastic, C - ceramic

■ MB90895 series

Built-in dual operation Flash memory



- Maximum clock frequency: 16 MHz(32.768 kHz)
- Minimum execution time: 62.5 ns(122.1 μs)
- Operating temperature range: -40 °C to +105 °C

Part number	Operating power supply voltage (V)	Package		Functions
		LQFP	PGA	
MB90F897	+3.5 to +5.5	48P	-	I/O ports: 34 Max. (MB90F897: Dual clock) , 36 Max. (MB90F897S: Single clock) CAN interface: 1ch. Timebase timer (WDT): 18-bit × 1 ch. Watch timer PPG timer: 16-bit × 2 ch. (8-bit × 4 ch.) A/D converter: 8/10-bit × 8 ch. Real time I/O: 16-bit input capture unit (ICU) × 4 ch. UART : 2 ch. Reload timer: 16-bit × 2 ch. External interrupts: 4ch. Low-power consumption modes: Sleep, stop, sub, watch, time base timer, CPU intermittent operation mode
MB90F897S		48P	-	
MB90V495G	+4.5 to +5.5	-	256C	

Packages: P - plastic, C - ceramic

16-bit Proprietary F²MC-16LX Family CAN Controller Products

(Continued)

Pin count	Main functions	Series name	Type	ROM	RAM	Part number					
64	CAN interface (1 ch), UART for LIN (2 ch), I ² C (1 ch), A/D converter (10 bit × 15 ch), reload timer (16 bit × 4 ch), PPG timer (16 bit × 6 ch), ICU (16 bit × 6 ch), IOU (16 bit × 4 ch), external interrupts (8 ch)	MB90350E series	MASK	64 KB	4 KB	MB90351E					
						MB90351ES					
						MB90351TE					
						MB90351TES					
				128 KB	4 KB	MB90352E					
						MB90352ES					
			Flash memory	Flash	128 KB	4 KB	Equivalent device MB90350E series	MB90F351E			
								MB90F351ES			
								MB90F351TE			
								MB90F351TES			
								128 KB	4 KB	Equivalent device MB90350E series	MB90F352E
											MB90F352ES
MB90F352TE											
MB90F352TES											
Evaluation device	Evaluation device	30 KB	Evaluation target device MB90350E series	MB90V340E-101							
				MB90V340E-102							

(Continued)

(Continued)

16-bit Proprietary F²MC-16LX Family CAN Controller Products

■ MB90350E series

For car bodies control, etc.

MB90352E/ES/TE/TES
ROM 128 KB
RAM 4 KB

MB90F352E/ES/TE/TES
Flash memory 128 KB
RAM 4 KB

- Maximum clock frequency : 24 MHz
- Minimum execution time : 41.6 ns
- Operating temperature range : -40 to +125 °C

MB90351E/ES/TE/TES
ROM 64 KB
RAM 4 KB

MB90F351E/ES/TE/TES
Flash memory 64 KB
RAM 4 KB

MB90V340E
RAM 30 KB

<Evaluation device>

Part number	Operating power supply voltage (V)	Package		Functions
		LQFP (0.65 mm pitch)	PGA	
MB90351E *2	+3.5 to +5.5	64P	–	I/O ports: 51 Max. (single clock) 49 Max. (dual clock) Flash memory : Dual operation Flash (MB90F351E/ES/TE/TES are excluded.) CAN interface : 1 ch. Timebase timer (WDT): 18-bit × 1 ch. Reload timer: 16-bit × 4 ch. PPG timer : 16-bit × 6 ch. (8-bit × 10 ch.) 16 bit input/output timer : input capture unit (ICU) × 6 ch output compare unit (OCU) × 4 ch free-run timer × 2 ch UART for LIN : 2 ch. A/D converter : 8/10-bit × 15 ch. I ² C: 1 ch External interrupt : 8 ch Low voltage/CPU operation detection reset (MB90351TE/351TES/352TE/352TES/F351TE/F351TES/F352TE/ F352TES) Low-power consumption modes: Sleep, stop, sub, sub sleep, watch, CPU intermittent operation, time base timer mode
MB90351ES *1		64P	–	
MB90351TE *2		64P	–	
MB90351TES *1		64P	–	
MB90352E *2		64P	–	
MB90352ES *1		64P	–	
MB90352TE *2		64P	–	
MB90352TES *1		64P	–	
MB90F351E *2		64P	–	
MB90F351ES *1		64P	–	
MB90F351TE *2		64P	–	
MB90F351TES *1		64P	–	
MB90F352E *2		64P	–	
MB90F352ES *1		64P	–	
MB90F352TE *2		64P	–	
MB90F352TES *1		64P	–	
MB90V340E-101 *1	+4.5 to +5.5	–	299C	
MB90V340E-102 *2		–	299C	

Packages: P - plastic, C - ceramic

*1 : single clock, *2 : dual clock

16-bit Proprietary F²MC-16LX Family CAN Controller Products

(Continued)

Pin count	Main functions	Series name	Type	ROM	RAM	Part number					
64	CAN interface (1 ch), UART for LIN (2 ch), I ² C (1 ch), A/D converter (10 bit × 15 ch), reload timer (16 bit × 4 ch), PPG timer (16 bit × 6 ch), ICU (16 bit × 6 ch), IOU (16 bit × 4 ch), external interrupts (8 ch)	MB90350E series	MASK	64 KB	4 KB	MB90356E					
						MB90356ES					
						MB90356TE					
						MB90356TES					
				128 KB	4 KB	MB90357E					
						MB90357ES					
			Flash memory	Flash	128 KB	4 KB	Equivalent device MB90350E series	MB90F356E			
								MB90F356ES			
								MB90F356TE			
								MB90F356TES			
								128 KB	4 KB	Equivalent device MB90350E series	MB90F357E
											MB90F357ES
MB90F357TE											
MB90F357TES											
Evaluation device	Evaluation target device	30 KB	Evaluation target device MB90350E series	MB90V340E-103							
				MB90V340E-104							

(Continued)

(Continued)

16-bit Proprietary F²MC-16LX Family CAN Controller Products

MB90350E series

For car bodies control, etc.

MB90357E/ES/TE/TES
ROM 128 KB
RAM 4 KB

MB90F357E/ES/TE/TES
Flash memory 128 KB
RAM 4 KB

- Maximum clock frequency : 24 MHz
- Minimum execution time : 41.6 ns
- Operating temperature range : -40 to +125 °C

MB90356E/ES/TE/TES
ROM 64 KB
RAM 4 KB

MB90F356E/ES/TE/TES
Flash memory 64 KB
RAM 4 KB

MB90V340E
RAM 30 KB

<Evaluation device>

Part number	Operating power supply voltage (V)	Package		Functions
		LQFP (0.65 mm pitch)	PGA	
MB90356E *2	+3.5 to +5.5	64P	–	I/O ports: 51 Max. (single clock) 49 Max. (dual clock) Flash memory : Dual operation Flash (MB90F356E/ES/TE/TES are excluded.) CAN interface : 1 ch. Timebase timer (WDT): 18-bit × 1 ch. Reload timer: 16-bit × 4 ch. PPG timer : 16-bit × 6 ch. (8-bit × 10 ch.) 16 bit input/output timer : input capture unit (ICU) × 6 ch output compare unit (OCU) × 4 ch free-run timer × 2 ch UART for LIN : 2 ch. A/D converter : 8/10-bit × 15 ch. I ² C: 1 ch External interrupt : 8 ch Low voltage/CPU operation detection reset (MB90356TE/356TES/357TE/357TES/F356TE/F356TES/F357TE/ F357TES) Low-power consumption modes: Sleep, stop, sub, sub sleep, watch, CPU intermittent operation, time base timer mode
MB90356ES *1		64P	–	
MB90356TE *2		64P	–	
MB90356TES *1		64P	–	
MB90357E *2		64P	–	
MB90357ES *1		64P	–	
MB90357TE *2		64P	–	
MB90357TES *1		64P	–	
MB90F356E *2		64P	–	
MB90F356ES *1		64P	–	
MB90F356TE *2		64P	–	
MB90F356TES *1		64P	–	
MB90F357E *2		64P	–	
MB90F357ES *1		64P	–	
MB90F357TE *2		64P	–	
MB90F357TES *1	64P	–		
MB90V340E-103 *1	+4.5 to +5.5	–	299C	
MB90V340E-104 *2		–	299C	

Packages: P - plastic, C - ceramic

*1 : single clock, *2 : dual clock

16-bit Proprietary F²MC-16LX Family CAN Controller Products

(Continued)	(Continued)								
Pin count	Main functions	Series name	Type	ROM	RAM	Part number			
64	UART/SIO (2 ch.) A/D converter (8/10-bit × 8 ch.), external interrupts (8 ch.), input capture (16-bit × 4 ch.), 8/16-bit PPG timer (2 ch.), reload timer (16-bit × 2 ch.), free-run timer (16-bit × 1 ch.), CAN interface (1 ch.)	MB90495G series	MASK	64 KB	2 KB	MB90497G			
			Flash memory		Equivalent device				
			Flash	64 KB	2 KB	MB90497G	MB90F497G		
				128 KB	2 KB		MB90F498G		
		Evaluation device		2 KB	MB90495G series	MB90V495G			
100	CAN interface (2 ch.), UART (2 ch.), A/D converter (8/10-bit × 8 ch.), SMC (4 ch.), external interrupts (8 ch.), input capture (16-bit × 4 ch.), PPG timer (16-bit × 3 ch.), watch timer, reload timer (16-bit × 2 ch.), free-run timer (16-bit × 1 ch.), Sound generator, LCD controller/driver	MB90420 GA/GC series	MASK	128 KB	6 KB	MB90423GA			
						MB90423GC			
			Flash memory		Equivalent device				
			Flash	128 KB	6 KB	MB90423GA	MB90F423GA		
					MB90423GC	MB90F423GC			
		Evaluation device		6 KB	MB90420GA/GC series	MB90V420G			

16-bit Proprietary F²MC-16LX Family CAN Controller Products

■ MB90495G series

For car bodies control, etc.

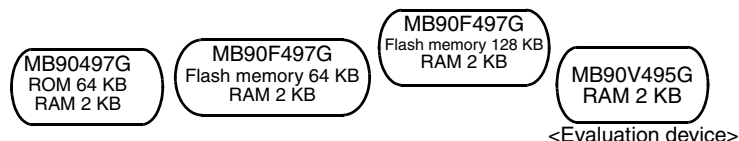

- Maximum clock frequency: 16 MHz(32.768 kHz)
- Minimum execution time: 62.5 ns(122.1 μs)
- Operating temperature range: -40°C to +105°C

Part number	Operating power supply voltage (V)	Package			Functions
		QFP	LQFP	PGA	
MB90497G	+4.5 to +5.5	64P	64P	-	I/O ports: 49 Max. Timebase timer (WDT): 18-bit × 1 ch. PPG timer: 16-bit × 2 ch. (8-bit × 4 ch.) UART/SIO: 1ch. Analog section: 8/10-bit A/D converter × 8 ch. Real time I/O: 16-bit input capture unit (ICU) × 4 ch. 16-bit free-run timer × 1 ch. Reload timer: 16-bit × 2 ch. CAN interface: 1 ch. Watch timer External interrupt: 8ch. Low-power consumption modes: Sleep, stop, sub, watch, CPU intermittent operation, time base timer mode
MB90F497G		64P	64P	-	
MB90F498G		64P	64P	-	
MB90V495G		-	-	256C	

Packages: P - plastic, C - ceramic
SMC: Stepper motor controller

■ MB90420GA/420GC series

Automotive applications, etc.

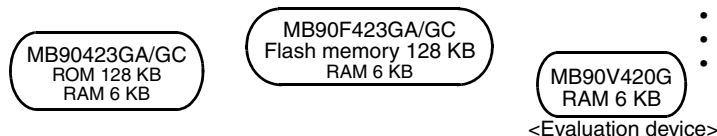

- Maximum clock frequency: 16 MHz (32.768 kHz)
- Minimum execution time: 62.5 ns (122.1 μs)
- Operating temperature range: -40°C to +105°C

Part number	Operating power supply voltage (V)	Package			Functions
		QFP	LQFP	PGA	
MB90423GA	+4.5 to +5.5	100P	100P	-	I/O ports: 58 Max. CAN interface: 2ch. Timebase timer (WDT): 18-bit × 1 ch. Watch timer, Sound generator PPG timer: (16-bit × 3 ch.) Analog section: 8/10-bit A/D converter × 8 ch. Real time I/O: 16-bit input capture unit (ICU) × 4 ch. 16-bit free-run timer × 1 ch. UART: 2 ch., Reload timer: 16-bit × 2 ch. Stepper motor controller: 4 ch. LCD controller/driver: 96 elements, 2 to 4 common, 12 to 24 segments, 16 × 8-bit LCD display RAM For single clock : MB90423GA/F423GA For dual clock : MB90423GC/F423GC/V420G External interrupts: 8ch. Low-voltage detection reset (MB90423GA/F423GA) Low-power consumption modes: Sleep, stop, sub, watch, time base timer, CPU intermittent operation mode
MB90423GC		100P	100P	-	
MB90F423GA		100P	100P	-	
MB90F423GC		100P	100P	-	
MB90V420G		-	-	256C	

Packages: P - plastic, C - ceramic

16-bit Proprietary F²MC-16LX Family CAN Controller Products

(Continued)	Pin count	(Continued) Main functions	Series name	Type	ROM	RAM	Part number
(Continued)	100	CAN interface (1ch.), UART (2 ch.), A/D converter (8/10-bit × 8ch.), SMC (4 ch.), external interrupts (8 ch.), input capture (16-bit × 4 ch.), PPG timer (16-bit × 3 ch.), watch timer, reload timer (16-bit × 2 ch.), free-run timer (16-bit × 1 ch.), Sound generator, LCD controller/ driver	MB90425 GA/GC series	MASK	64 KB	4 KB	MB90427GA MB90427GC
				MASK	128 KB	6 KB	MB90428GA MB90428GC
				Flash	128 KB	6 KB	Flash memory MB90425GA → MB90F428GA MB90425GC → MB90F428GC Equivalent device
				Evaluation device		6 KB	Evaluation target device MB90425GA/GC series → MB90V420G
			MB90440G series	MASK	128 KB	6 KB	MB90443G **
				Flash	128 KB	6 KB	Flash memory MB90443G → MB90F443G Equivalent device
				Evaluation device		14 KB	Evaluation target device MB90440G series → MB90V440G

** : Under planning

16-bit Proprietary F²MC-16LX Family CAN Controller Products

■ MB90425GA/425GC series

Automotive applications, etc.



- Maximum clock frequency: 16 MHz(32.768 kHz)
- Minimum execution time: 62.5 ns(122.1 μs)
- Operating temperature range: -40°C to +105°C

Part number	Operating power supply voltage (V)	Package			Functions
		QFP	LQFP	PGA	
MB90427GA	+4.5 to +5.5	100P	100P	-	I/O ports: 58 Max. CAN interface: 1ch. (2ch.: MB90V420) Timebase timer (WDT): 18-bit × 1ch. Watch timer (main clock) Sound generator PPG timer: 16-bit × 3 ch. Analog section: 8/10-bit A/D converter × 8ch. Real time I/O: 16-bit input capture unit (ICU) × 4 ch. 16-bit free-run timer × 1ch. UART: 2 ch. Reload timer: 16-bit × 2 ch. Stepper motor controller: 4 ch. LCD controller/driver: 96 elements, 2 to 4 common, 12 to 24 segments, 16 × 8-bit LCD display RAM For single clock : MB90427GA/428GA/F428GA For dual clock : MB90427GC/428GC/F428GC/V420G External interrupts: 8 ch. Low-voltage detection reset (MB90427GA/428GA/F428GA) Low-power consumption modes: Sleep, stop, sub, watch, time base timer, CPU intermittent operation mode
MB90427GC		100P	100P	-	
MB90428GA		100P	100P	-	
MB90428GC		100P	100P	-	
MB90F428GA		100P	100P	-	
MB90F428GC		100P	100P	-	
MB90V420G		-	-	256C	

Packages: P - plastic, C - ceramic

■ MB90440G series

For gateway, etc.

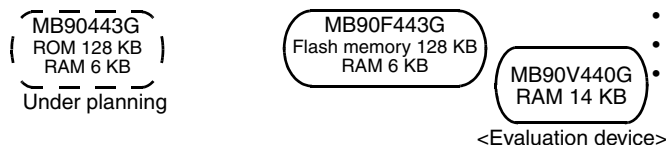

- Maximum clock frequency: 16 MHz (32.768 kHz)
- Minimum execution time: 62.5 ns (125 μs)
- Operating temperature range: -40°C to +105°C

Part number	Operating power supply voltage (V)	Package		Functions
		QFP	PGA	
○ MB90443G	+4.5 to +5.5	100P	-	I/O ports: 81 CAN interface: 3 ch. Timebase timer (WDT): 18-bit × 1 ch. 8/16-bit PPG timer: 4 ch. Analog section: 8/10-bit A/D converter × 8 ch. Real time I/O: 16-bit input capture unit (ICU) × 8 ch. 16-bit output compare unit (OCU) × 4 ch. 16-bit free-run timer × 1 ch. UART: 2 ch. SIO: 1 ch. Reload timer: 16-bit × 2 ch. External interrupts: 8 ch. external bus interface Low-power consumption modes: Sleep, stop, sub, watch, CPU inter- mittent operation, time base timer mode
MB90F443G		100P	-	
MB90V440G		-	256C	

Packages: P - plastic, C - ceramic

○: Under planning

16-bit Proprietary F²MC-16LX Family CAN Controller Products

(Continued)	(Continued)	(Continued)	(Continued)	(Continued)	(Continued)	(Continued)	(Continued)	
Pin count	Main functions	Series name	Type	ROM	RAM	Part number		
100	A/D converter (10-bit × 8 ch.), UART (2 ch.) SIO (1 ch.), CAN interface (1 ch.), SMC (4ch.), external interrupts (8 ch.), input capture (16-bit × 6 ch.), output compare (16-bit × 4 ch.), 8/16-bit PPG timer (6 ch.), Reload timer (16-bit × 2 ch.), free-run timer (16-bit × 1 ch.), watch timer (1 ch.)	MB90595G series	MASK	128 KB	4 KB	MB90598G		
			Flash memory		Equivalent device			
			Flash	128 KB	4 KB	MB90598G	MB90F598G	
			Evaluation device		6 KB	Evaluation target device		
						MB90595G series	MB90V595G	
	A/D converter (8/10 bit × 8 ch.) , CAN controller (2 ch.) , UART (2 ch.) , SIO(1 ch.) external interrupts (8 ch.) , input capture unit (16-bit × 8 ch.) , output compare unit (16-bit × 4 ch.) , 8/16-bit PPG timer (4 ch.) , reload timer (16-bit × 2 ch.) , free-run timer (16-bit × 1 ch.)	MB90540G/ GS series	MASK	128 KB	6 KB	MB90543G		
						MB90543GS		
Flash memory			Equivalent device					
			Flash	128 KB	6 KB	MB90540G series	MB90F543G	
						MB90540GS series	MB90F543G S	
			Evaluation device		8 KB	Evaluation target device		
						MB90540G/ GS series	MB90V540G	

16-bit Proprietary F²MC-16LX Family CAN Controller Products

■ MB90595G series

For dashboard, car audio, etc.

MB90598G
ROM 128KB
RAM 4 KB

MB90F598G
Flash memory 128KB
RAM 4 KB

MB90V595G
RAM 6 KB

<Evaluation device>

- Maximum clock frequency: 16 MHz
- Minimum execution time: 62.5 ns
- Operating temperature range: -40°C to +85°C

Part number	Operating power supply voltage (V)	Package		Functions
		QFP	PGA	
MB90598G	+4.5 to +5.5	100P	–	I/O ports: 78 Timebase timer (WDT): 18-bit × 1 ch. UART: 2 ch. Analog section: 10-bit A/D converter × 8ch. Real time I/O: 16-bit input capture unit (ICU) × 4 ch. 16-bit output compare unit (OCU) × 4 ch. 16-bit free-run timer × 1 ch. 8/16-bit PPG timer: 6 ch. SIO: 1 ch. Reload timer: 16-bit × 2 ch. CAN interface: 1 ch. SMC: 4 ch. External interrupts: 8 ch. Low-power consumption modes: Sleep, stop, time base timer, CPU intermittent operation mode
MB90F598G		100P	–	
MB90V595G		–	256C	

Packages: P - plastic, C - ceramic
SMC: Stepper motor controller

■ MB90540G/540GS series

For dashboard, car audio, etc.

MB90543G/GS
ROM 128 KB
RAM 6 KB

MB90F543G/GS
Flash memory 128KB
RAM 6 KB

MB90V540G
RAM 8 KB

<Evaluation device>

- Maximum internal clock frequency: 16 MHz (32.768 kHz)
- Minimum execution time: 62.5 ns (122.1 μs)
- Operating temperature range: -40°C to +105°C

Part number	Operating power supply voltage (V)	Package			Functions
		QFP	LQFP	PGA	
MB90543G	+3.5 to +5.5	100P	100P	–	I/O ports : 81 Max. Timebase timer (WDT) : 18-bit × 1 ch. CAN controller : 2 ch. 8/16-bit PPG timer : 4 ch. SIO : 1 ch. Analog section : 8/10-bit A/D converter × 8 ch. Real time I/O : 16-bit input capture unit (ICU) × 8 ch. 16-bit output compare unit (OCU) × 4 ch. 16-bit free-run timer × 1 ch. UART : 2 ch. Reload timer : 16-bit × 2 ch. For single clock : MB90543GS/F543GS For dual clock : MB90543G/F543G/V540G External interrupts : 8 ch. Low-power consumption modes : Sleep, stop, sub, CPU intermittent operation, watch, time base timer mode
MB90F543G	+4.5 to +5.5	100P	100P	–	
MB90543GS	+3.5 to +5.5	100P	100P	–	
MB90F543GS	+4.5 to +5.5	100P	100P	–	
MB90V540G		–	–	256C	

Packages: P - plastic, C - ceramic

16-bit Proprietary F²MC-16LX Family CAN Controller Products

(Continued)	(Continued)	(Continued)	(Continued)	(Continued)	(Continued)	(Continued)	(Continued)	
Pin count	Main functions	Series name	Type	ROM	RAM		Part number	
100	CAN controller (2 ch), UART for LIN (4 ch.), A/D converter (10-bit × 16/24 ch.), external interrupts (16 ch.), ICU (16 bit × 8 ch), OCU (16 bit × 8 ch), 8 / 16-bit PPG timer (8 ch.), reload timer (16-bit × 4 ch.)	MB90340E/ES series (CAN 1 ch.)	MASK	64 KB	2 KB		MB90346E	
							MB90346ES	
							MB90346CE	
							MB90346CES	
				128 KB	6 KB		MB90347E	
							MB90347ES	
							MB90347CE	
							MB90347CES	
				128 KB	16 KB		MB90348E **	
							MB90348ES **	
							MB90348CE **	
							MB90348CES **	
				256 KB	16 KB		MB90349E	
							MB90349ES	
							MB90349CE	
							MB90349CES	
			Flash memory					
			Flash			Equivalent device		
				64 KB	2 KB	MB90340E/ES series (CAN 1 ch.)	MB90F346E	
								MB90F346ES
								MB90F346CE
								MB90F346CES
				128 KB	6 KB	MB90340E/ES series (CAN 1 ch.)	MB90F347E	
								MB90F347ES
								MB90F347CE
								MB90F347CES
				256 KB	16 KB	MB90340E/ES series (CAN 1 ch.)	MB90F349E	
								MB90F349ES
								MB90F349CE
								MB90F349CES
			Evaluation device			Evaluation target device		
			Evaluation device		30 KB	MB90340E/ES series (CAN 1 ch.)	MB90V340E-102	
					MB90340E/ES series (CAN 1 ch.)		MB90V340E-101	

** : Under planning

16-bit Proprietary F²MC-16LX Family CAN Controller Products

■ MB90340E/340ES series (CAN 1 ch.)

For car air-conditioner, etc.

- Maximum internal clock frequency: 24 MHz (32.768 kHz)
- Minimum execution time: 42.0 ns
- Operating temperature range: -40°C to +105 °C

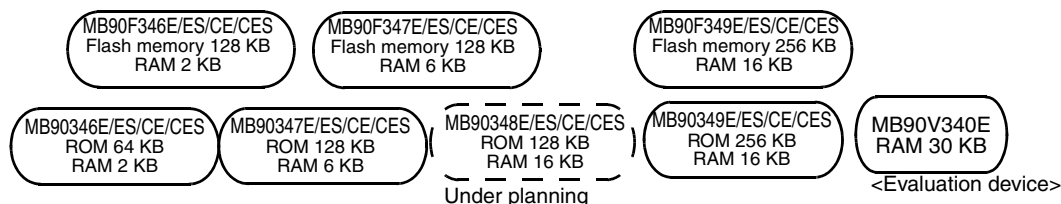

Part number	Operating power supply voltage (V)	Package			Functions	
		LQFP	QFP	PGA		
MB90346E	+3.5 to +5.5	100P	100P	–	I/O ports : 80 (MB90346E/346CE/F346E/F346CE/347E/347CE/ F347E/F347CE/348E/348CE/349E/349CE/F349E/ F349CE/V340E-102: Dual clock) 82 (MB90346ES/346CES/F346ES/F346CES/347ES/ 347CES/F347ES/F347CES/348ES/348CES/349ES/ 349CES/F349ES/F349CES/V340E-101: Single clock) Timebase timer (WDT) : 18-bit × 1 ch. CAN controller : 1 ch. (MB90V340E-101/102: 3 ch.) 8/16-bit PPG timer : 16 bit × 8 ch. (16 bit × 16 ch.) Analog section : 8/10-bit A/D converter × 16 ch. (MB90346E/346ES/F346E/F346ES/347E/ 347ES/F347E/F347ES/348E/348ES/349E/ 349ES/F349E/F349ES) 8/10-bit A/D converter × 24 ch. (MB90346CE/346CES/F346CE/F346CES/ 347CE/347CES/F347CE/F347CES/348CE/ 348CES/349CE/349CES/F349CE/F349CES/ V340E-101/V340E-102) Real time I/O : 16-bit input capture unit (ICU) × 8 ch. 16-bit output compare unit (OCU) × 8 ch. UART for LIN × 4 ch. (MB90V340E-101/102: 5 ch.) Reload timer : 16 bit × 4 ch. I ² C bus interface: 2 ch. (MB90346CE/346CES/F346CE/F346CES/ 347CE/347CES/348CE/348CES/349CE/ 349CES/F349CE/F349CES/V340E-101/V340E- 102) External interrupts : 16 ch. Low-power consumption modes : Sleep, stop, sub, CPU intermittent operation, watch, time base timer mode	
MB90346ES		100P	100P	–		
MB90346CE		100P	100P	–		
MB90346CES		100P	100P	–		
MB90F346E		100P	100P	–		
MB90F346ES		100P	100P	–		
MB90F346CE		100P	100P	–		
MB90F346CES		100P	100P	–		
MB90347E		100P	100P	–		
MB90347ES		100P	100P	–		
MB90347CE		100P	100P	–		
MB90347CES		100P	100P	–		
MB90F347E		100P	100P	–		
MB90F347ES		100P	100P	–		
MB90F347CE		100P	100P	–		
MB90F347CES		100P	100P	–		
○ MB90348E		100P	100P	–		
○ MB90348ES		100P	100P	–		
○ MB90348CE		100P	100P	–		
○ MB90348CES		100P	100P	–		
MB90349E		100P	100P	–		
MB90349ES		100P	100P	–		
MB90349CE		100P	100P	–		
MB90349CES		100P	100P	–		
MB90F349E		100P	100P	–		
MB90F349ES		100P	100P	–		
MB90F349CE		100P	100P	–		
MB90F349CES		100P	100P	–		
MB90V340E-101		+4.5 to +5.5	–	–		299C
MB90V340E-102			–	–		299C

Packages: P - plastic, C - ceramic

○: Under planning

16-bit Proprietary F²MC-16LX Family CAN Controller Products

(Continued)	Pin count	(Continued)	Main functions	Series name	Type	ROM	RAM	Part number			
	100		CAN controller (1 ch.), UART for LIN (4 ch.), converter (10-bit × 16/24 ch.), external interrupts (16 ch.), ICU (16-bit × 8 ch.), OCU (16-bit × 8 ch.), 8 / 16-bit PPGtimer (8 ch.), reload timer (16-bit × 4 ch.)	MB90340E/ES series (CAN 2 ch.)	MASK	128 KB	16 KB	MB90341E **			
										MB90341ES **	
										MB90341CE **	
										MB90341CES **	
									256 KB	16 KB	MB90342E
											MB90342ES
											MB90342CE
											MB90342CES
							Flash	Flash memory		Equivalent device	
								256 KB	16 KB	MB90340E/ES series (2 ch.)	MB90F342E
											MB90F342ES
											MB90F342CE
											MB90F342CES
								384 KB	20 KB	MB90340E/ES series (2 ch.)	MB90F343E **
									MB90F343ES **		
									MB90F343CE **		
									MB90F343CES **		
					512 KB	20 KB		MB90340E series	MB90F345E		
									MB90F345ES		
									MB90F345CE		
								MB90F345CES			
					Evaluation device	Evaluation target device					
							30 KB	MB90340E series (2 ch.)	MB90V340E-102		
							MB90340ES series (2 ch.)	MB90V340E-101			

** : Under planning

16-bit Proprietary F²MC-16LX Family CAN Controller Products

■ MB90340E/340ES series (CAN 2 ch.)

For car audio, etc.

- Maximum clock frequency: 16 MHz (32.768 kHz)
- Minimum execution time: 42.0 ns
- Operating temperature range: -40 °C to +105 °C

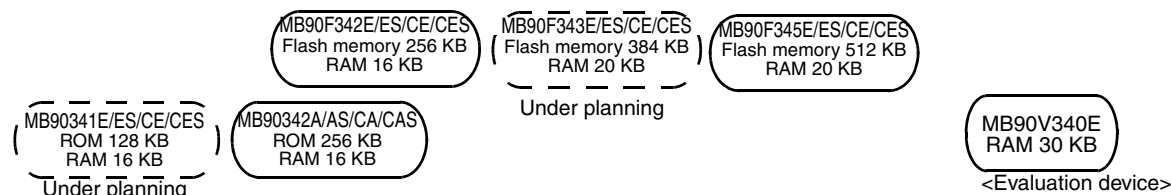

Part number	Operating power supply voltage (V)	Package			Functions
		LQFP	QFP	PGA	
○ MB90341E	+3.5 to +5.5	100P	100P	–	I/O ports: 80 (MB90341E/341CE/342E/342CE/F342E/F342CE/ F343E/F343CE/F345E/F345CE/V340E-102: Dual clock) 82 (MB90341ES/341CES/342ES/342CES/F342ES/ F342CES/F343ES/F343CES/F345ES/F345CES/ V340E-101: Single clock) Timebase timer (WDT): 18-bit × 1 ch. CAN controller : 2 ch. (MB90V340E-101/102: 3 ch.) PPG timer: 16-bit × 8 ch. (8-bit × 16 ch.) Analog section: 8/10-bit A/D converter × 16 ch (MB90341E/341ES/342E/342ES/F342E/ F342ES/F343E/F343ES/F345E/F345ES) 8/10-bit A/D converter × 24 ch (MB90341CE/341CES/342CE/342CES/ F342CE/F342CES/F343CE/F343CES/F345CE/ F345CES/V340E-101/V340E-102) Real time I/O: 16-bit input capture unit (ICU) × 8 ch. 16-bit output compare unit (OCU) × 8 ch. UART for LIN × 4 ch. (MB90V340E-101/102: 5 ch.) Reload timer: 16-bit × 4 ch. I ² C bus interface: 2 ch. (MB90341CE/341CES/342CE/342CES/ F342CE/F342CES/F343CE/F343CES/F345CE/ F345CES/V340E-101/V340E-102) External interrupts: 16 ch. Low-power consumption modes: Sleep, stop, sub, watch, time base timer, CPU intermittent operation mode
○ MB90341ES		100P	100P	–	
○ MB90341CE		100P	100P	–	
○ MB90341CES		100P	100P	–	
MB90342E		100P	100P	–	
MB90342ES		100P	100P	–	
MB90342CE		100P	100P	–	
MB90342CES		100P	100P	–	
MB90F342E		100P	100P	–	
MB90F342ES		100P	100P	–	
MB90F342CE		100P	100P	–	
MB90F342CES		100P	100P	–	
○ MB90F343E		100P	100P	–	
○ MB90F343ES		100P	100P	–	
○ MB90F343CE		100P	100P	–	
○ MB90F343CES		100P	100P	–	
MB90F345E		100P	100P	–	
MB90F345ES		100P	100P	–	
MB90F345CE		100P	100P	–	
MB90F345CES		100P	100P	–	
MB90V340E-101	+4.5 to +5.5	–	–	299C	
MB90V340E-102		–	–	299C	

Packages: P - plastic, C - ceramic

○: Under planning

16-bit Proprietary F²MC-16LX Family CAN Controller Products

(Continued)	(Continued)	(Continued)	(Continued)	(Continued)	(Continued)	(Continued)	(Continued)			
Pin count	Main functions	Series name	Type	ROM	RAM	Part number				
100	UART (2 ch.), SIO (1ch.), A/D converter (8/10-bit × 8ch.), external interrupts (8 ch.), input capture (16-bit × 8ch.), output compare (16-bit × 4ch.), 8/16-bit PPG timer (4 ch.), Reload timer (16-bit × 2ch.), free-run timer (16-bit × 1ch.), CAN controller (1ch.)	MB90545G/ GS series	MASK	64 KB	2 KB	MB90547G				
						MB90547GS				
				128 KB	4 KB	MB90548G				
					MB90548GS					
			256 KB	6 KB	MB90549G					
					MB90549GS					
			Flash				128 KB	4 KB	Equivalent device	
									MB90549G	MB90F548GL
									MB90F548G	
									MB90549GS	MB90F548GLS
MB90F548GS										
256 KB	6 KB	MB90549G							MB90F549G	
		MB90549GS							MB90F549GS	
		8 KB							MB90549G	MB90F546G
									MB90549GS	MB90F546GS
Evaluation device	8 KB	MB90545G/ GS series							Evaluation target device MB90V540G	

16-bit Proprietary F²MC-16LX Family CAN Controller Products

■ MB90545G/545GS series

For dashboard, car audio, etc.

- Maximum clock frequency: 16 MHz(32.768 kHz)
- Minimum execution time: 62.5 ns(122.1 μs)
- Operating temperature range: -40°C to +105°C

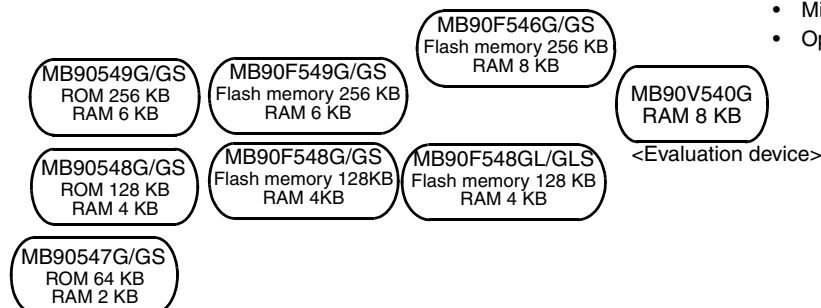

Part number	Operating power supply voltage (V)	Package			Functions
		QFP	LQFP	PGA	
MB90547G	+3.5 to +5.5	100P	100P	–	I/O ports: 80 Max. Timebase timer (WDT): 18-bit × 1 ch. CAN controller: 1 ch. 8/16-bit PPG timer: 4 ch. SIO: 1ch. Analog section: 8/10-bit A/D converter × 8 ch. Real time I/O: 16-bit input capture unit (ICU) × 8 ch. 16-bit output compare unit (OCU) × 4 ch. 16-bit free-run timer × 1 ch. UART: 2 ch. Reload timer: 16-bit × 2 ch. For single clock : MB90549GS/F546GS/F548GS/F548GLS/ 547GS/548GS/F549GS For dual clock : MB90549G/F546G/F548G/F548GL/F549G/ 547G/548G/V540G External interrupts: 8 ch. Low-power consumption modes: Sleep, stop, sub, CPU intermittent operation, watch, time base timer mode
MB90547GS		100P	100P	–	
MB90548G		100P	100P	–	
MB90548GS		100P	100P	–	
MB90549G	+4.5 to +5.5	100P	100P	–	
MB90549GS		100P	100P	–	
MB90F546G		100P	100P	–	
MB90F546GS		100P	100P	–	
MB90F548G	+3.5 to +5.5	100P	100P	–	
MB90F548GS		100P	100P	–	
MB90F548GL		100P	100P	–	
MB90F548GLS		100P	100P	–	
MB90F549G	+4.5 to +5.5	100P	100P	–	
MB90F549GS		100P	100P	–	
MB90V540G		–	–	256C	

Packages: P - plastic, C - ceramic

16-bit Proprietary F²MC-16LX Family CAN Controller Products

(Continued)	(Continued)						
Pin count	Main functions	Series name	Type	ROM	RAM	Part number	
100	UART for LIN (1 ch.) (MB90F946A: 2 ch.) , UART (1 ch.) , SIO (1 ch.) , I ² C (1 ch.) , CAN interface (1 ch.) , A/D converter (8/10-bit × 15 ch.) , external interrupts (8 ch.) , ICU (16-bit × 6 ch.) , OCU (16-bit × 4 ch.) , PPG timer (8/16-bit × 6 ch.) , Reload timer (16-bit × 1 ch.) , free-run timer (16-bit × 2 ch.) , μDMA (16 ch.) , clock modulation	MB90945 series	MASK	128 KB	6 KB	MB90947A	
			Flash	128 KB	6 KB	MB90F947A	
				256 KB	12 KB	MB90F949A	
				384 KB	16 KB	MB90F946A	
			Evaluation device		30 KB	MB90945 series	MB90V390HB
						Evaluation target device	

(Continued) (Continued)

16-bit Proprietary F²MC-16LX Family CAN Controller Products

■ MB90945 series

For car body control, etc.

MB90F947A
Flash memory 128 KB
RAM 6 KB

MB90F949A
Flash memory 256 KB
RAM 12 KB

MB90F946A
Flash memory 384 KB
RAM 16 KB

MB90947A
ROM 128 KB
RAM 6 KB

MB90V390HB
RAM 30 KB

<Evaluation device>

- Maximum clock frequency: 24 MHz
- Minimum execution time: 42 ns
- Operating temperature range: -40 to +105 °C

Part number	Operating power supply voltage (V)	Package		Functions
		QFP (0.65 mm pitch)	PGA	
MB90947A	+3.5 to +5.5	100P	–	I/O ports: 82 Max. Timebase timer (WDT): 18-bit × 1 ch. UART for LIN : 1 ch. (only MB90F946A) Analog section: 8/10-bit A/D converter × 15 ch. Real time I/O: 16-bit input capture unit (ICU) × 6 ch. 16-bit output compare unit (OCU) × 4 ch. 16-bit free-run timer × 2 ch. PPG timer: 8/16-bit × 6 ch. UART : 1 ch SIO : 1 ch Reload timer: 16-bit × 1 ch. CAN interface: 1 ch. External interrupts: 8 ch. μDMA : 16 ch Clock modulation : 1 ch Low-power consumption modes: Sleep, stop, sub, watch, CPU intermittent operation, time base timer mode
MB90F947A		100P	–	
MB90F949A		100P	–	
MB90F946A		100P	–	
MB90V390HB		–	299C	

Packages: P - plastic, C - ceramic

16-bit Proprietary F²MC-16LX Family CAN Controller Products

(Continued)	Pin count	Main functions	Series name	Type	ROM	RAM	Part number		
(Continued)	100	A/D converter (10-bit × 8 ch.), UART (3 ch.) SIO (1 ch.), CAN interface (2ch.), SMC (4 ch.), sound generator (1 ch.), external interrupts (8 ch.), input capture (16-bit × 6 ch.), output compare (16-bit × 6 ch.), 8/16-bit PPG timer (6 ch.), Reload timer (16-bit × 2 ch.), free-run timer (16-bit × 1 ch.), watch timer (1 ch.)	MB90590G series	MASK	256 KB	6 KB	MB90594G		
					384 KB	8 KB	MB90591G		
				Flash	Flash memory		Equivalent device		
					256 KB	6 KB	MB90594G	MB90F594G	
				384 KB	8 KB	MB90591G	MB90F591G		
				Evaluation device	Evaluation target device		8 KB	MB90590G series	MB90V590G
				(Continued)	120	CAN interface (2ch.), UART (3 ch.) SIO (1 ch.), A/D converter (8/10-bit × 15 ch.), SMC (6 ch.), external interrupts (8 ch.), input capture (16-bit × 6ch.), output compare (16-bit × 8 ch.), free-run timer (16-bit × 2 ch.), 8/16-bit PPG timer (6 ch.), Reload timer (16-bit × 2 ch.), sound generator (1 ch.)	MB90390 series	MASK	384 KB
Flash memory		Equivalent device							
Flash	384 KB	10 KB	MB90394HA					MB90F394HA	
Evaluation device	Evaluation target device		30 KB					MB90390 series	MB90V390HB

16-bit Proprietary F²MC-16LX Family CAN Controller Products

■ MB90590G series

For dashboard, etc.

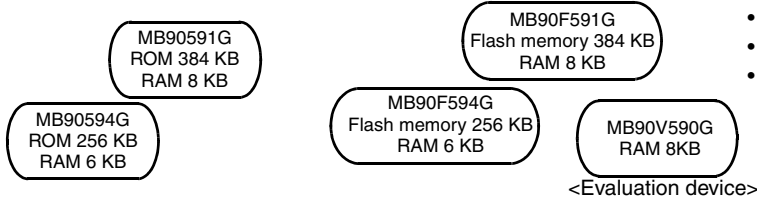

- Maximum clock frequency: 16 MHz
- Minimum execution time: 62.5 ns
- Operating temperature range: -40°C to +85°C

Part number	Operating power supply voltage (V)	Package		Functions
		QFP	PGA	
MB90591G	+4.75 to +5.25	100P	–	I/O ports: 78 Max. Timebase timer (WDT): 18-bit × 1 ch. UART: 3ch. Analog section: 10-bit A/D converter × 8 ch. Real time I/O: 16-bit input capture unit (ICU) × 6 ch. 16-bit output compare unit (OCU) × 6 ch. 16-bit free-run timer × 1 ch. 8/16-bit PPG timer: 6 ch. SIO: 1 ch. Reload timer: 16-bit × 2 ch. CAN interface: 2 ch. SMC: 4ch Sound generator: 1 ch. Watch timer: 1 ch. External interrupts: 8 ch. Low-power consumption modes: Sleep, stop, time base timer, CPU intermittent operation mode
MB90594G	+4.5 to +5.5	100P	–	
MB90F591G	+4.75 to +5.25	100P	–	
MB90F594G	+4.5 to +5.5	100P	–	
MB90V590G		–	256C	

Packages: P - plastic, C - ceramic
SMC: Stepper motor controller

■ MB90390 series

For dashboard, etc.



- Maximum clock frequency: 24 MHz
- Minimum execution time: 50 ns
- Operating temperature range: -40°C to +85°C

Part number	Operating power supply voltage (V)	Package		Functions
		QFP	PGA	
MB90394HA	+3.5 to +5.5	120P	–	I/O ports: 96 Max. CAN interface: 2 ch. Timebase timer (WDT): 18-bit × 1 ch. Real time watch timer: 1 ch. Sound generator: 1 ch. 8/16-bit PPG timer: 6 ch. Analog section: 8/10-bit A/D converter × 15 ch. Real time I/O: 16-bit input capture unit (ICU) × 6 ch. 16-bit output compare unit (OCU) × 8 ch. 16-bit free-run timer × 2 ch. UART: 3 ch. I ² C bus interface × 1 ch. (MB90394HA) Reload timer: 16-bit × 2 ch. SIO: 1 ch. SMC: 6 ch. External interrupts: 8 ch. Low-power consumption modes: Sleep, stop, time base timer, CPU intermittent operation mode
MB90F394HA		120P	–	
MB90V390HB	+4.5 to +5.5	–	299C	

Packages: P - plastic, C - ceramic
SMC: Stepper motor controller

16-bit Proprietary F²MC-16LX Family CAN Controller Products

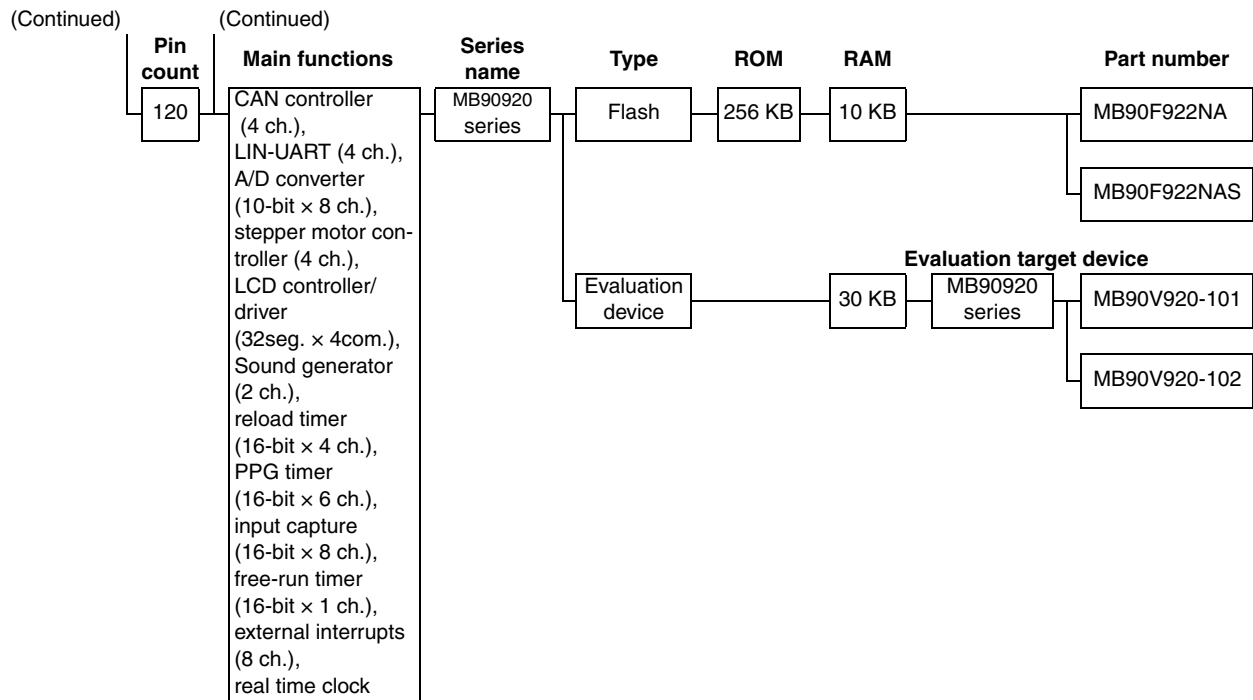

16-bit Proprietary F²MC-16LX Family CAN Controller Products

■ MB90920 series

For mobile products, etc.

MB90F922NA
Flash memory 256 KB
RAM 10 KB

MB90F922NAS
Flash memory 256 KB
RAM 10 KB

MB90V920-101/102
RAM 30 KB

<Evaluation device>

- Maximum clock frequency: 32 MHz
- Minimum execution time: 62.5 ns
- Operating temperature range: -40°C to +105°C

Part number	Operating power supply voltage (V)	Package		Functions
		LQFP	PGA	
MB90F922NA *1	+4.0 to +5.5	120P	–	I/O ports: 93 Max. (MB90F922NAS) 91 Max. (MB90F922NA) Analog section: 10-bit A/D converter × 8 ch. CAN interface (16 message buffer): 4 ch. LIN-UART: 4 ch. (LIN/SCI) Stepper motor controller: 4 ch. LCD controller: 32 segments, 4 common Sound generator: 2 ch. Reload timer: 16-bit × 4 ch. PPG timer: 16-bit × 6 ch. External interrupts: 8 ch. Input capture unit (ICU): 16-bit × 6 ch. Free-run timer: 16-bit × 1 ch. Real time clock
MB90F922NAS *2		120P	–	
MB90V920-101 *1	+4.5 to +5.5	–	256C	
MB90V920-102 *2		–	256C	

Packages: P - plastic, C - ceramic
 *1 : single clock, *2 : dual clock

16-bit Proprietary F²MC-16LX Family LCD Controller/Driver Products

F²MC-16LX Family LCD Controller/Driver Products

	Pin count	Main functions	Series name	Type	ROM	RAM	Part number				
F ² MC-16LX Family LCD Controller/Driver Product	100	LCD controller (48 seg × 4 com.), A/D converter (10 bit × 12 ch.), I ² C interface (1 ch.), UART (2 ch.), SIO (2 ch.), external interrupts (4 ch.), PPG timer (16-bit × 2 ch.), reload timer (16-bit × 3 ch.), WDT	MB90800 series	MASK	128 KB	4 KB	MB90803				
					256 KB	16 KB	MB90804 **				
				Flash memory	Flash	128 KB	4 KB	MB90800 series	MB90F803		
						192KB	10 KB	MB90800 series	MB90F809 *		
						256 KB	16 KB	MB90800 series	MB90F804		
				Evaluation target device	Evaluation device	28 KB	MB90800 series	MB90V800			
					120	A/D converter (10-bit × 8ch.), D/A converter (8-bit × 2ch.), UART (1ch.) SIO (2ch.), external interrupts (8ch.), input capture (16-bit × 2ch.), output compare (16-bit × 8ch.), PPG timer (8-bit × 2ch.), up/down counter (8-bit × 2ch.), reload timer (16-bit × 2ch.), free-run timer (16-bit × 2ch.), LCD controller/driver (32seg. × 4com.), timer (1ch.)	MB90520B series	MASK	64 KB	4 KB	MB90522B
									128 KB	4 KB	MB90523B
								Flash memory	Flash	128 KB	4 KB
Evaluation target device	Evaluation device	6 KB	MB90520B series					MB90V520A			

** : Under planning
* : Under development

(Continued)

16-bit Proprietary F²MC-16LX Family LCD Controller/Driver Products

■ MB90800 series

For home audio, electric power meter, compact camera, phone, etc.

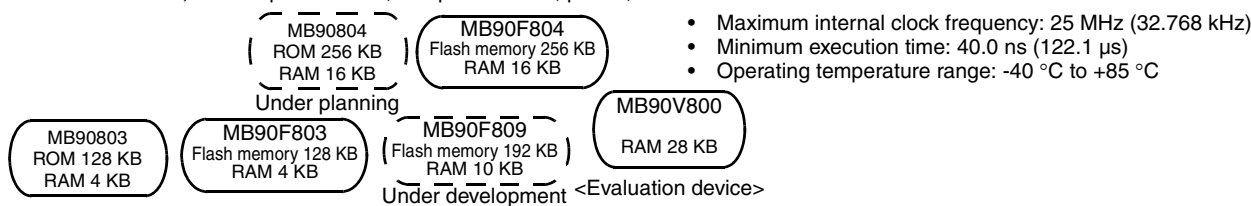

Part number	Operating power supply voltage (V)	Package		Functions
		QFP	PGA	
MB90803	+3.0 to +3.6	100P	-	I/O ports: 70 Max. (sub clock : 68 Max.) Timebase timer (WDT) : 18-bit × 1 ch. UART : 2 ch. I ² C bus interface× 1 ch. Analog section: 10-bit A/D converter × 12 ch. Real time I/O: 16-bit input capture unit (ICU) × 2 ch. 16-bit output compare unit (OCU) × 2 ch. 16-bit free-run timer × 1 ch. PPG timer: 16-bit × 2 ch. SIO : 2 ch. Reload timer:16-bit × 3 ch. LCD controller: 192 elements, 2 to 4 common, 12 to 48 segments, 24 × 8-bit LCD display RAM External interrupts: 4ch. Low-power consumption modes: Sleep, stop, watch, time base timer, sub, CPU intermittent operation mode
○ MB90804		100P	-	
MB90F803		100P	-	
MB90F804		100P	-	
◎ MB90F809		100P	-	
MB90V800		-	299C	

Packages: P - plastic
 ○: Under planning
 ◎: Under development

■ MB90520B series

For cameras

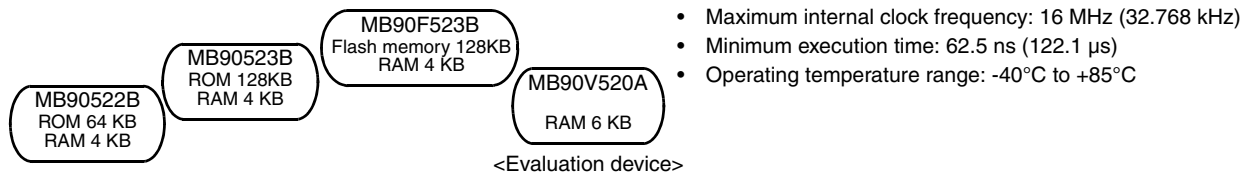

Part number	Operating power supply voltage (V)	Package			Functions
		QFP	LQFP	PGA	
MB90522B	+3.0 to +5.5	120P	120P	-	I/O ports: 85 Max. Timebase timer (WDT): 18-bit × 1 ch. UART: 1ch. Analog section: 10-bit A/D converter × 8 ch. 8-bit D/A converter × 2ch. Real time I/O: 16-bit input capture unit (ICU) × 2 ch. 16-bit output compare unit (OCU) × 8 ch. 16-bit free-run timer × 2 ch. Up/down counter: 8-bit × 2ch. (16-bit × 1 ch.) PPG timer: 8-bit × 2ch. (16-bit × 1 ch.) SIO: 2 ch. Reload timer:16-bit × 2 ch. LCD controller/driver: 128 elements, 2 to 4 common, 8 to 32 segments, 16 × 8-bit LCD display RAM Timer: 1 ch. External interrupts: 8 Low-power consumption modes: Sleep, stop, watch, time base timer, sub, CPU intermittent operation mode
MB90523B		120P	120P	-	
MB90F523B		120P	120P	-	
MB90V520A		-	-	256C	

Packages: P - plastic, C - ceramic

16-bit Proprietary F²MC-16LX Family LCD Controller/Driver Products

(Continued)

Pin count	Main functions	Series name	Type	ROM	RAM	Part number
144	A/D converter (8/10-bit × 12ch.), D/A converter (8-bit × 2ch.) Comparator, LCDC (9 seg. × 4 com.), LPC interface, PS/2 interface (3ch) , UART (3ch.) , I ² C interface (1ch.) , multi address I ² C interface (1ch.) , bridge oscillation, external interrupts (6ch.), key on wake up (8ch.), reload timer (16-bit × 4ch.), PPG timer (16-bit × 3ch.), watch clock timer	MB90370 series	MASK	64 KB	6 KB	MB90372
			Flash memory		Equivalent device	
			Flash	64 KB	6 KB	MB90370 series MB90F372
			Evaluation target device			
			Evaluation device		15.7 KB	MB90370 series MB90V370

16-bit Proprietary F²MC-16LX Family LCD Controller/Driver Products

■ MB90370 series

For Notebook personal computer

- Maximum internal clock frequency: 16 MHz (32.768 kHz)
- Minimum execution time: 62.5 ns (122.1 μs)
- Operating temperature range: -40°C to +85°C

MB90372
ROM 64KB
RAM 6KB

MB90F372
Flash memory 64KB
RAM 6KB

MB90V370
RAM 15.7KB

<Evaluation device>

F²MC-16LX Family

Part number	Operating power supply voltage (V)	Package		Functions
		LQFP	PGA	
MB90372	+3.0 to +3.6	144P	–	I/O ports: 120 Max. LPC interface PS/2 interface I ² C bus interface: 1 ch. Multi address I ² C bus interface: 1 ch. bridge oscillation LCD controller/driver: 9 segments × 4 common Watch clock timer PPG timer: 16-bit × 3 ch. Reload timer: 16-bit × 4 ch. Analog section: 8/10-bit A/D converter × 12 ch. 8-bit D/A converter × 2 ch. UART: 3ch. External interrupts: 4 ch. Key on wake up: 8 ch. Timebase timer (WDT): 18-bit × 1 ch. Low-power consumption modes: Sleep, stop, time base timer, CPU intermittent operation, sub, watch, mode
MB90F372		144P	–	
MB90V370		–	256C	

Packages: P - plastic, C - ceramic

16-bit Proprietary F²MC-16LX Family FL Controller Products

■ F²MC-16LX Family FL (Fluorescent) Display Controller Products

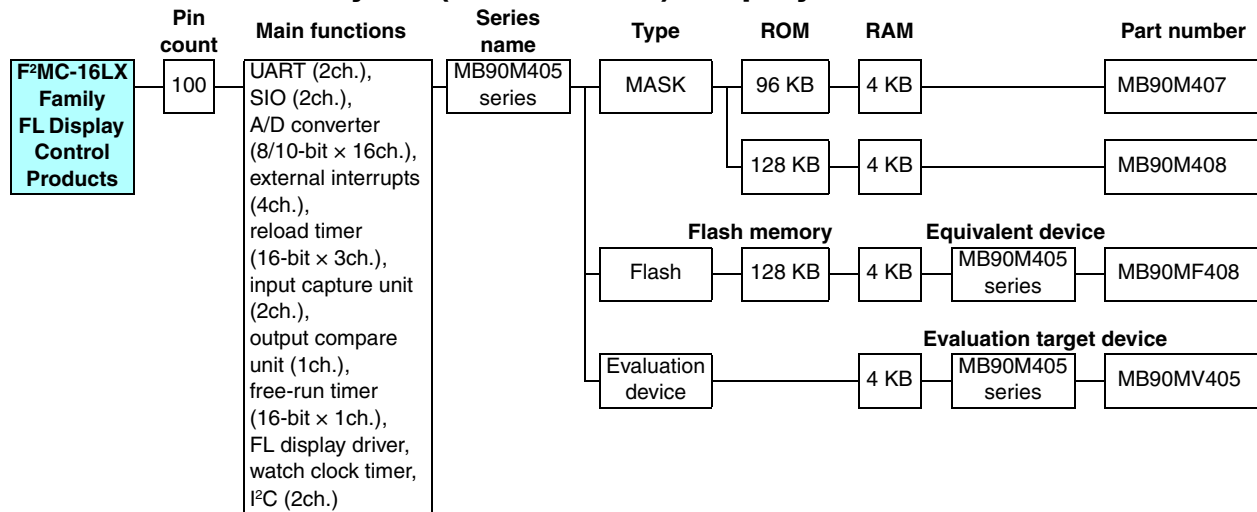

16-bit Proprietary F²MC-16LX Family FL Controller Products

■ MB90M405 series

FL display panel control

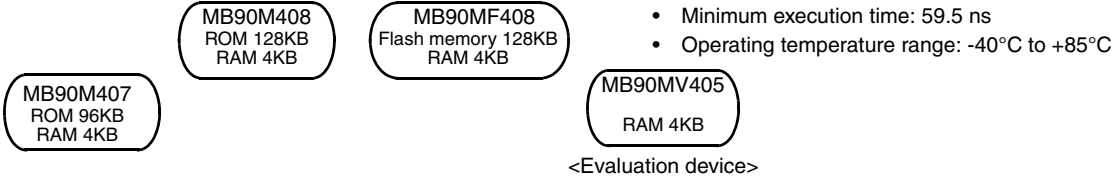

- Maximum internal clock frequency: 16.8 MHz
- Minimum execution time: 59.5 ns
- Operating temperature range: -40°C to +85°C

Part number	Operating power supply voltage (V)	Package		Functions
		QFP	PGA	
MB90M407	+3.0 to +3.6	100P	–	I/O ports: 26 Max. Timebase timer (WDT): 18-bit × 1 ch. UART: 2 ch. Analog section: 8/10-bit A/D converter × 16 ch.
MB90M408	+3.0 to +3.6	100P	–	Real time I/O: 16-bit input capture unit (ICU) × 2 ch. 16-bit output compare unit (OCU) × 1 ch. 16-bit free-run timer × 1 ch.
MB90MF408	+3.0 to +3.6	100P	–	SIO: 2 ch. I ² C interface: 1 ch. FL display driver controller Reload timer: 16-bit × 3 ch.
MB90MV405	+3.0 to +3.6	–	256C	Watch clock timer External interrupts: 4 Low-power consumption modes: Sleep, stop, time base timer, CPU intermittent operation mode

Packages: P - plastic, C - ceramic

16-bit Proprietary F²MC-16LX Family USB function Products

F²MC-16LX Family USB function

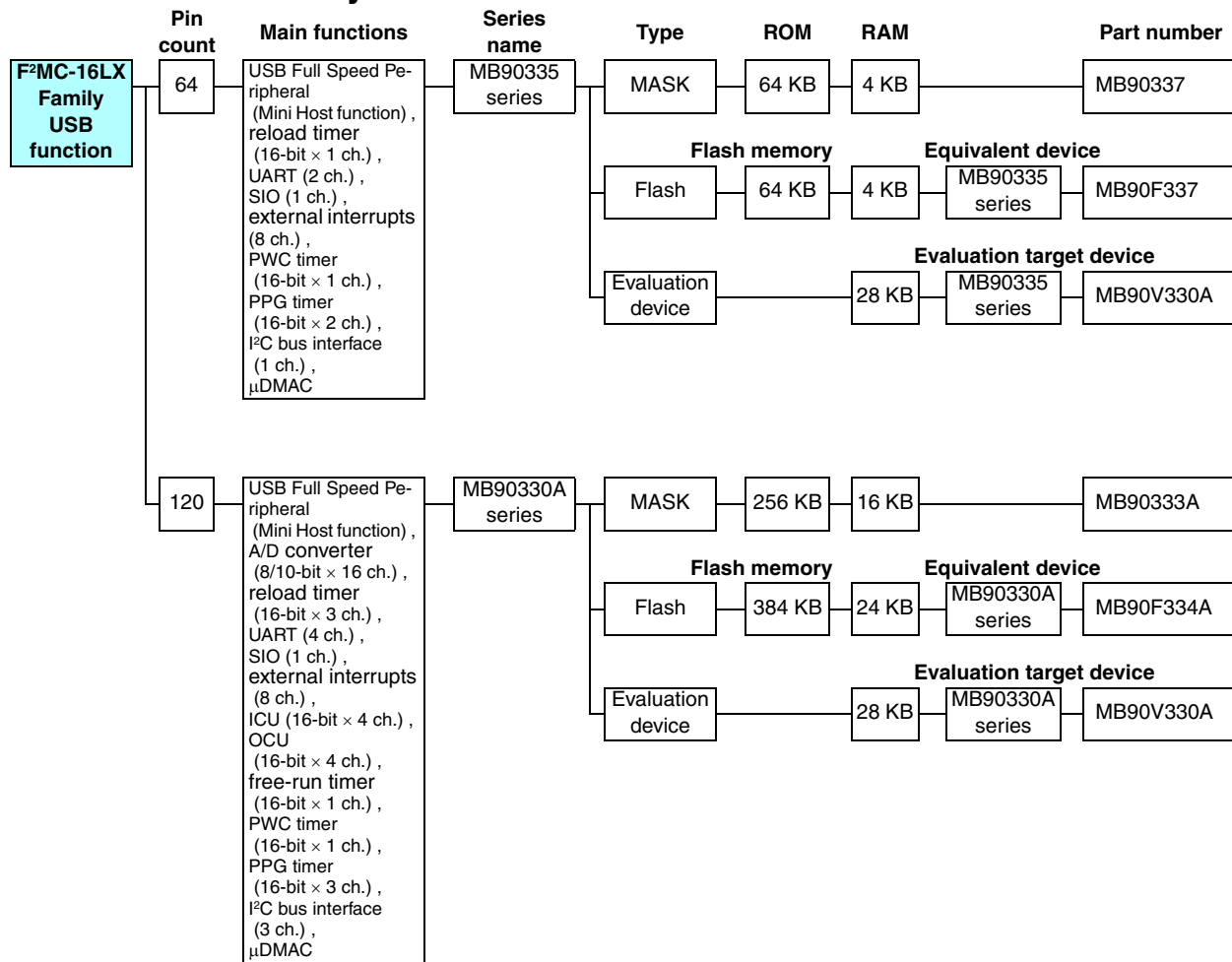

16-bit Proprietary F²MC-16LX Family USB function Products

■ MB90335 series

USB Full Speed Peripheral (Mini Host function)

MB90337
ROM 64KB
RAM 4KB

MB90F337
Flash memory 64KB
RAM 4KB

MB90V330A
RAM 28KB
Evaluation device

- Maximum internal clock frequency: 24 MHz
- Minimum execution time: 41.6 ns
- Operating temperature range: -40 °C to +85 °C (USB function : 0 °C to +70 °C)

Part number	Operating power supply voltage (V)	Package		Functions
		LQFP (0.65 mm pitch)	PGA	
MB90337	+3.0 to +3.6	64P	-	I/O ports: 45 Max. USB Full Speed Peripheral : Mini Host function (Hub not supported) Endpoint: 6 Max. μDMAC : 16 ch. Timebase timer (WDT): 18-bit × 1ch. PWC timer : 16-bit × 1 ch. PPG timer : 8-bit × 4 ch. (16-bit × 2 ch.) Reload timer: 16-bit × 2 ch. UART : 2 ch. SIO : 1 ch. I ² C bus interface : 1 ch. External interrupts: 8 Low-power consumption modes: Sleep, stop, CPU intermittent operation, time base timer, mode
MB90F337		64P	-	
MB90V330A		-	299C	

Packages: P - plastic, C - ceramic

■ MB90330A series

USB Full Speed Peripheral (Mini Host function)

MB90333A
ROM 256KB
RAM 16KB

MB90F334A
Flash memory 384KB
RAM 24KB

MB90V330A
RAM 28KB
Evaluation device

- Maximum internal clock frequency: 24 MHz (32.768 kHz)
- Minimum execution time: 41.6 ns (122.1 μs)
- Operating temperature range: -40 °C to +85 °C (USBfunction : 0 °C to +70 °C)

Part number	Operating power supply voltage (V)	Package			Functions
		LQFP (0.4 mm pitch)	LQFP (0.5 mm pitch)	PGA	
MB90333A	+3.0 to +3.6	120P	120P	-	I/O ports: 94 Max. USB Full Speed Peripheral : Mini Host function (Hub not supported) Endpoint: 6 Max. μDMAC : 16 ch. Analog section: 8/10-bit × 16 ch. Timebase timer (WDT): 18-bit × 1ch. Real time I/O: 16-bit input capture unit (ICU) × 4 ch. 16-bit output compare unit (OCU) × 4 ch. 16-bit free-run timer × 1 ch. PWC timer : 16-bit × 1 ch. PPG timer : 8-bit × 6 ch. (16-bit × 3 ch.) Reload timer: 16-bit × 3 ch. UART : 4 ch. SIO : 1 ch. I ² C bus interface : 3 ch. External interrupts: 8 ch. Watch timer Low-power consumption modes: Sleep, stop, watch, sub, CPU intermittent operation, time base timer mode
MB90F334A		120P	120P	-	
MB90V330A		-	-	299C	

Packages: P - plastic, C - ceramic

16-bit Proprietary F²MC-16FX Family

F²MC-16FX Family

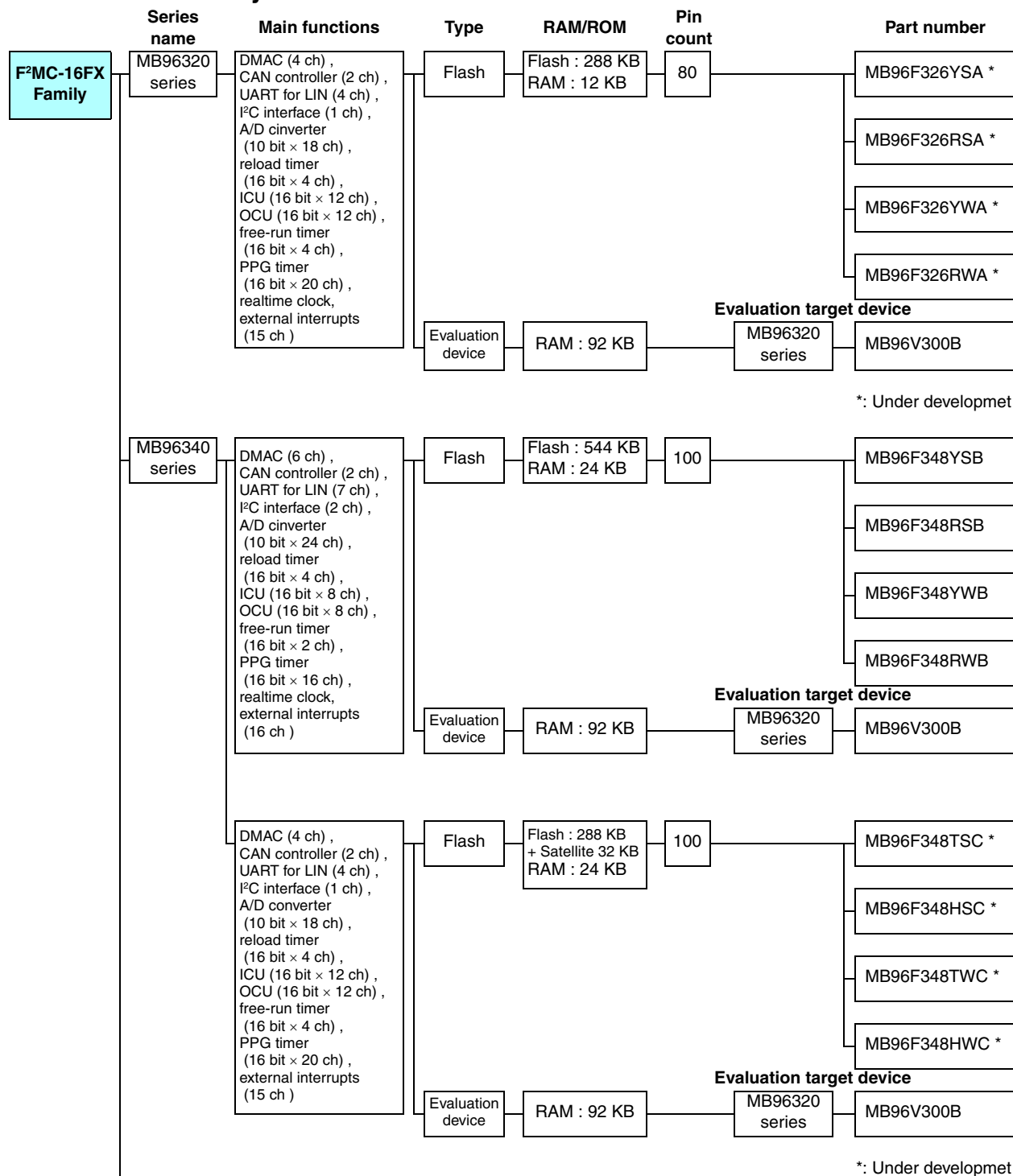

(Continued)

16-bit Proprietary F²MC-16FX Family

■ MB96320 series

For mobile body control, air-conditioner, car audio, etc

MB96F326YSA/RSA/YWA/RWA
Flash : 288 KB
RAM : 12 KB
Under development

MB96V300B
RAM : 92 KB
<Evaluation device>

- Maximum clock frequency: 56 MHz
- Minimum execution time: 17.8 ns
- Operating temperature range: -40 °C to +125 °C

Part number	Operating power supply voltage (V)	Package		Functions
		LQFP (0.5 mm)	BGA	
◎ MB96F326YSA	+3.0 to +5.5	80P	-	I/O ports: 64 Max. (MB96F326YWA/F326RWA: Single clock, "W" suffix) 66 Max. (MB96F326YSA/F326RSA: Dual clock, "S" suffix) DMAC : 4 ch. CAN : 2 ch. UART for LIN : 4 ch. I ² C bus interface : 1 ch. A/D converter : 8/10-bit × 18 ch. Reload timer : 16-bit × 4 ch. 16-bit I/O timer : ICU × 12 ch., OCU × 6 ch., free-run timer × 4 ch. PPG timer : 16-bit × 20 ch. External interrupts : 15 ch. Real time clock (MB96F326YWA/F326RWA) Low voltage detection reset (MB96F326YSA/F326YWA)
◎ MB96F326RSA		80P	-	
◎ MB96F326YWA		80P	-	
◎ MB96F326RWA		80P	-	
MB96V300B		-	416C	

Packages: P - plastic, C - ceramic

◎ : Under development

■ MB96340 series

For mobile body control, air-conditioner, car audio, etc.

MB96F348YSB/RSB/YWB/RWB
Flash : 544 KB
RAM : 24 KB
Under development

MB96F348TSC/HSC/TWC/HWC
Flash : 544 KB + 32 KB
RAM : 24 KB
Under development

MB96V300B
RAM : 92 KB
<Evaluation device>

- Maximum clock frequency: 56 MHz
- Minimum execution time: 17.8 ns
- Operating temperature range: -40 °C to +125 °C (MB96F348H/F348T : -40 °C to +105 °C)

Part number	Operating power supply voltage (V)	Package			Functions
		LQFP (0.5 mm)	QFP (0.65 mm)	BGA	
MB96F348YSB	+3.0 to +5.5	100P	100P	-	I/O ports: 80 Max. (MB96F348YWB/F348RWB/F348TWC/F348HWC : Dual clock) 82 Max. (MB96F348YSB/F348RSB/F348TSC/F348HSC : Single clock) Satellite Flash : 32 KB (MB96F348TSC/F348HSC/TWC/F348HWC) DMAC : 6 ch. CAN : 2 ch. Reload timer : 16-bit × 4 ch. PPG timer : 8-bit × 10 ch. or 16-bit × 16 ch. 16-bit I/O timer : ICU × 8 ch., OCU × 8 ch., free-run timer × 2 ch. UART for LIN : 7 ch. A/D converter : 8/10-bit × 24 ch. I ² C bus interface : 2 ch. External interrupts : 16 ch. Real time clock (MB96F348YWB/F348RWB) Low voltage detection reset (MB96F348YSB/F348YWB/F348TSC/F348TWC)
MB96F348RSB		100P	100P	-	
MB96F348YWB		100P	100P	-	
MB96F348RWB		100P	100P	-	
◎ MB96F348TSC		100P	100P	-	
◎ MB96F348HSC		100P	100P	-	
◎ MB96F348TWC		100P	100P	-	
◎ MB96F348HWC		100P	100P	-	
MB96V300B		-	-	416C	

Packages: P - plastic, C - ceramic

◎ : Under development

16-bit Proprietary F²MC-16FX Family

(Continued)

Series name	Main functions	Type	RAM/ROM	Pin count	Part number
MB96350 series	DMAC (4 ch.) , CAN controller (2 ch.) , UART for LIN (4 ch.) , I ² C interface (1 ch.) , A/D cinverter (10-bit × 15 ch.) , reload timer (16-bit × 4 ch.) , ICU (16-bit × 6 ch.) , OCU (16-bit × 4 ch.) , free-run timer (16-bit × 2 ch.) , PPG timer (16-bit × 20 ch.) , realtime clock, external interrupts (13 ch.)	Flash	Flash : 288 KB RAM : 12 KB	64	MB96F356YSA *
					MB96F356RSA *
					MB96F356YWA *
					MB96F356RWA *
		Evaluation device	RAM : 92 KB	MB96350 series	MB96V300B
					Evaluation target device
*: Under developmet					
MB96380 series	DMAC (7 ch.) , CAN controller (2 ch.) , UART for LIN (5 ch.) , I ² C interface (1 ch.) , A/D cinverter (10-bit × 16 ch.) , reload timer (16-bit × 4 ch.) , ICU (16-bit × 8 ch.) , OCU (16-bit × 4 ch.) , free-run timer (16-bit × 2 ch.) , PPG timer (16-bit × 8 ch.) , realtime clock, external interrupts (16 ch.) , stepping motor controller (5 ch.) , sound generator (2 ch.) , LCD controller (4 com × 65 seg)	Flash	Flash : 416 KB RAM : 16 KB	120	MB96F387YSB *
					MB96F387RSB *
					MB96F387YWB *
					MB96F387RWB *
		Evaluation device	RAM : 92 KB	MB96380 series	MB96V300B
					Evaluation target device
*: Under developmet					

16-bit Proprietary F²MC-16FX Family

■ MB96350 series

For mobile body control, air-conditioner, car audio, etc.

MB96F356Y_{SB}/R_{SB}/Y_{WB}/R_{WB}
Flash : 288 KB
RAM : 12 KB
Under development

MB96V300B
RAM : 92 KB
<Evaluation device>

- Maximum clock frequency : 56 MHz
- Minimum execution time : 17.8 ns
- Operating temperature range : -40 °C to +125 °C

Part number	Operating power supply voltage (V)	Package			Functions
		LQFP (0.5 mm)	LQFP (0.65 mm)	BGA	
◎ MB96F356Y _{SB}	+3.0 to +5.5	64P	64P	-	I/O ports : 49 Max. (MB96F356Y _{WB} /F356R _{WB} : Dual clock) 51 Max. (MB96F356Y _{SB} /F356R _{SB} : Single clock) DMAC : 4 ch. CAN : 2 ch. Reload timer : 16-bit × 4 ch. PPG timer : 16-bit × 20 ch. 16-bit I/O timer : ICU × 6 ch., OCU × 4 ch., free-run timer × 2 ch. UART for LIN : 4 ch. A/D converter : 8/10-bit × 15 ch. I ² C bus interface : 1 ch. External interrupts : 13 ch. Real time clock (MB96F356Y _{WB} /F356R _{WB}) Low voltage detection reset (MB96F356Y _{SB} /F356Y _{WB})
◎ MB96F356R _{SB}		64P	64P	-	
◎ MB96F356Y _{WB}		64P	64P	-	
◎ MB96F356R _{WB}		64P	64P	-	
MB96V300B		-	-	416C	

Packages: P - plastic, C - ceramic

◎ : Under development

■ MB96380 series

For mobile body control, air-conditioner, car audio, etc.

MB96F387Y_{SA}/R_{SA}/Y_{WA}/R_{WA}
Flash : 416 KB
RAM : 16 KB
Under development

MB96V300B
RAM : 92 KB
<Evaluation device>

- Maximum clock frequency : 56 MHz
- Minimum execution time : 17.8 ns
- Operating temperature range : -40 °C to +125 °C

Part number	Operating power supply voltage (V)	Package		Functions
		LQFP (0.5 mm)	BGA	
◎ MB96F387Y _{SA}	+3.0 to +5.5	120P	-	I/O ports : 94 Max. (MB96F387Y _{WA} /F387R _{WA} : Dual clock) 82 Max. (MB96F387Y _{SA} /F387R _{SA} : Single clock) DMAC : 7 ch. CAN : 2 ch. Reload timer : 16-bit × 4 ch. PPG timer : 8-bit × 10 ch. or 16-bit × 6 ch. 16-bit I/O timer : ICU × 8 ch., OCU × 4 ch., free-run timer × 2 ch. UART for LIN : 5 ch. A/D converter : 8/10-bit × 16 ch. I ² C bus interface : 1 ch. External interrupts : 8 ch. Real time clock (MB96F387Y _{WA} /F387R _{WA}) Low voltage detection reset (MB96F387Y _{SA} /F387Y _{WA}) Stepping motor controller : 5 ch. Sound generator : 2 ch. LCD controller : 4 com × 65 seg
◎ MB96F387R _{SA}		120P	-	
◎ MB96F387Y _{WA}		120P	-	
◎ MB96F387R _{WA}		120P	-	
MB96V300B		-	-	

Packages: P - plastic, C - ceramic

◎ : Under development

■ F²MC-16LX Family Support Tools

Development Environment Features

(1) Enhancement of development efficiency

- Provides integrated total environment
SOFTUNE V3 Workbench (Manager + Debugger)
SOFTUNE V3 Workbench (Manager + Debugger) integrates programming language and debugging tools to improve the efficiency of the code-compile-debug cycle.
- High programming efficiency
C compiler support
SOFTUNE C checker and C analyzer support
Structured assembly language support
- High programming development efficiency
Provides real time OS (SOFTUNE REALOS/907)
Provides C library
Support C language and assembly source debugging function
- Easy operation by multi windows
SOFTUNE V3 Workbench (manager + debugger)
SOFTUNE C checker
SOFTUNE C analyzer
SOFTUNE REALOS configurator
SOFTUNE REALOS analyzer
SOFTUNE OSEK analyzer

(2) Efficient system development tools

- Provides real time debugging using real target board
Evaluation tool + SOFTUNE V3 Workbench emulator debugger
- Provides software debugging without target board
SOFTUNE V3 Workbench simulator debugger

(3) Total development environment

- Personal computer (IBM-PC)
- In Circuit Emulator tool (MB2140A series)

(4) Conformity with standards

- Improves versatility and portability of software resource
- C language: conforms to ANSI standard
 - C library: conforms to ANSI standard
 - Real time OS: conforms to μ ITRON specification

SOFTUNE V3

1. The SOFTUNE Integrated Development Environment

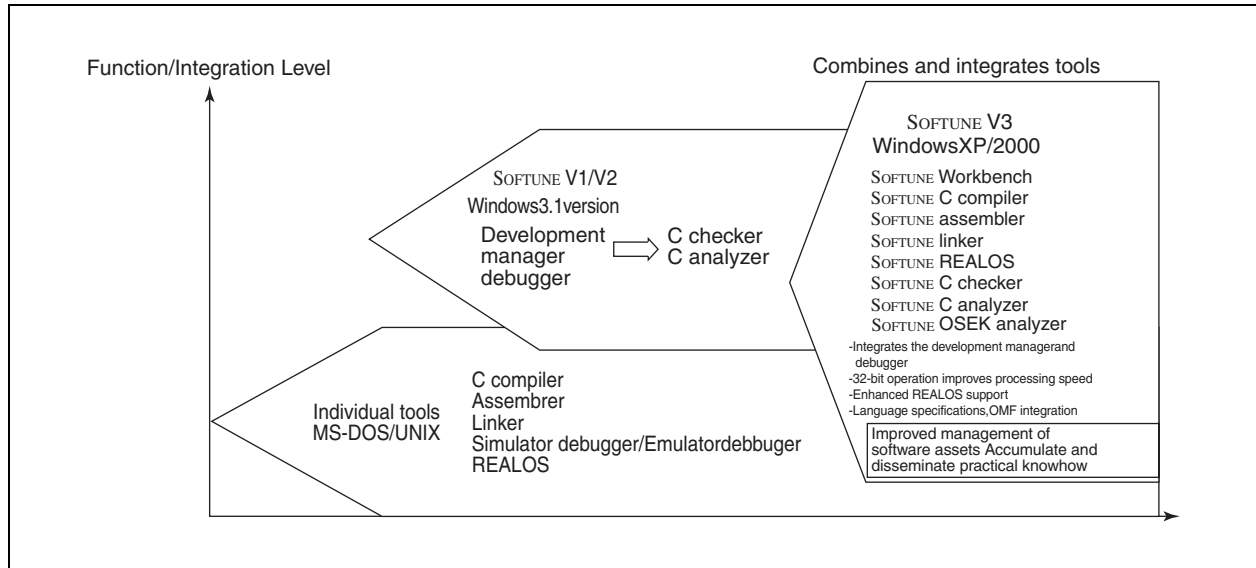

2. SOFTUNE V3 Structure and Features

Workbench Integrated project manager and debugger modules

Errors can be corrected on the fly, as they are discovered, and the resulting code can be debugged on the spot.

A variety of tools to support C-language coding

“C Checker” confirms code operation and “C Analyzer” analyzes the code’s structure.

Includes such tools as Configurator and Analyzer to facilitate the use of REALOS, which conforms to the μ ITRON specifications (Analyzer: under development).

The tool that supports development using OSEK/VDX specification OS is prepared (OSEK analyzer).

(1) Removing the Annoying Settings which are Part of Program Development

Developing programs for different systems requires the programmer to edit source code, perform actual builds and confirm program operation (debug). Finally, the programmer returns to the editing process to incorporate necessary changes, as indicated by debugging results.

SOFTUNE V3 is an integrated developing environment which is designed to perform such repetitive processes smoothly and efficiently. It is the third generation of SOFTUNE, which has evolved to meet various needs of our customers.

(2) Program Flow

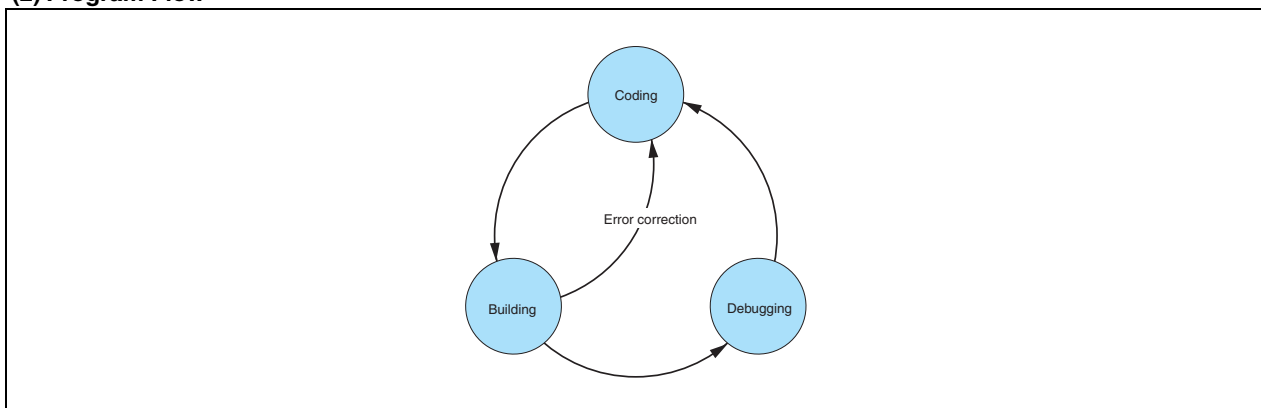

(3) Structure of SOFTUNE V3

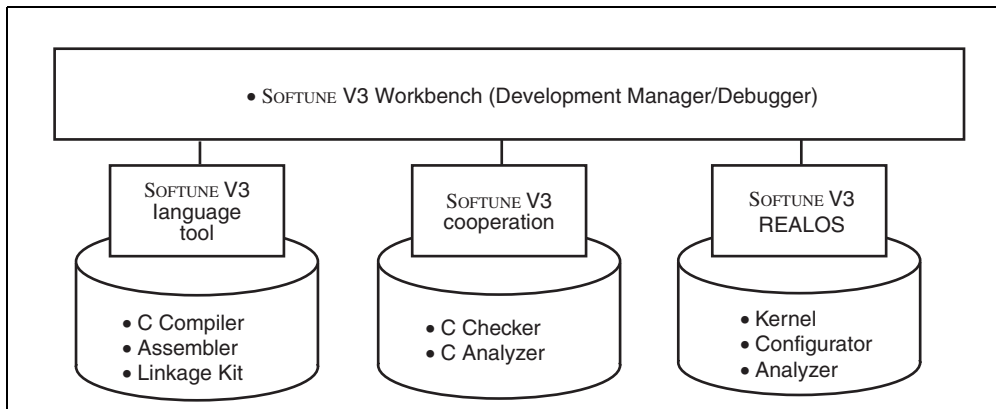

(4) Environment with SOFTUNE V3

The Efficient and Easy-to-Use Integrated Developing Environment

Program development requires repeated editing, make/build, and debugging operations. Performing these functions smoothly and effectively contributes to improved efficiency.

The SOFTUNE V3 integrated developing system is designed to meet program developers' numerous demands, while ensuring ease of use.

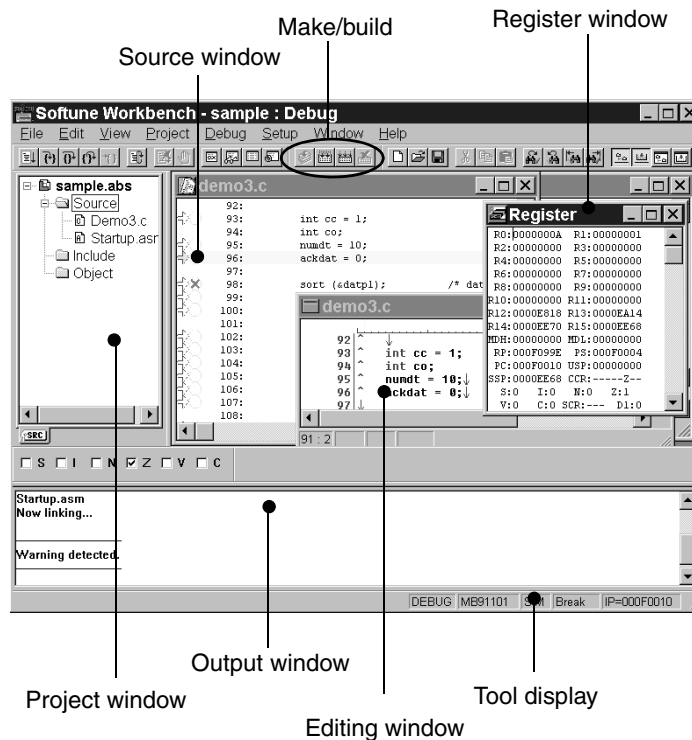

3. Manager Functions

Software programming proceeds according to the “project file,” which contains all the information needed for program development.

Workspace can manage two or more projects.

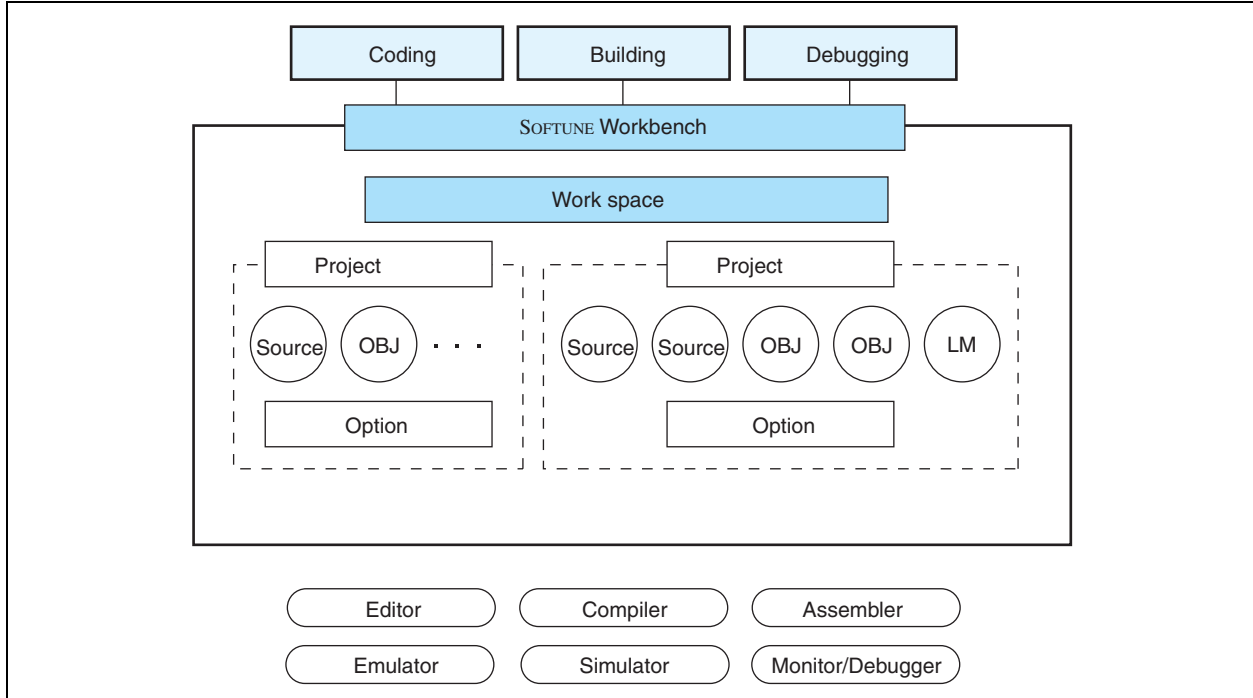

(1) Effective Project Usage

Whether working alone on several projects simultaneously or developing a project as a group, project files can be used to create a simple developing environment.

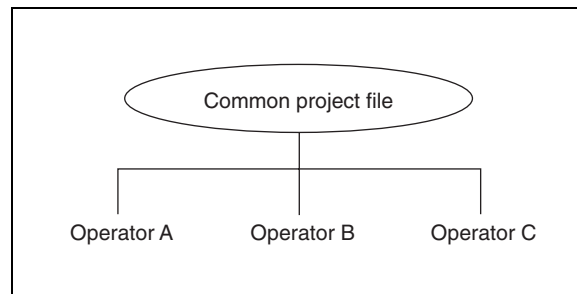

(2) Extremely Easy to Use

- Built-in Editor**
 The built-in editor comes complete with many useful functions, such as visual keyword emphasis and auto-indent.
- Error Jump and On-line Help**
 Errors that occur during builds are displayed in the output window at the bottom of the screen. To make a “Tag-jump” Double-click Mouse. Once on the error press “F1 key” for a more detailed error display.
- Cooperation with Commercially Available Editors**
 To meet developers’ requests to use editors to which they are accustomed, SOFTUNE can be configured to use the following commercially available editors: (Codewright32, TextPAD32 and others)

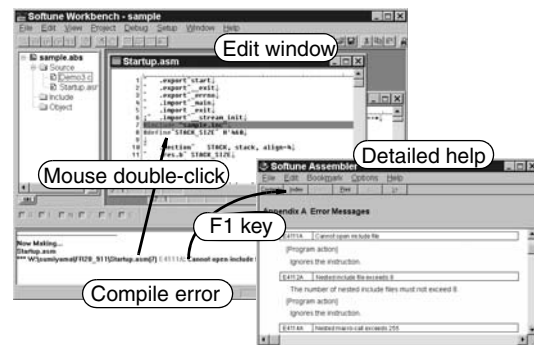

(3) Customizable Environment

When sharing files, cooperation with source generation management tools is assured, and file type conversion tools are called up, so that each person can operate in his or her own customized developing environment.

4. Debugger Function

SOFTUNE Workbench supports three debuggers that are needed at various stages of development. The appropriate debugger environment can be selected to match the situation.

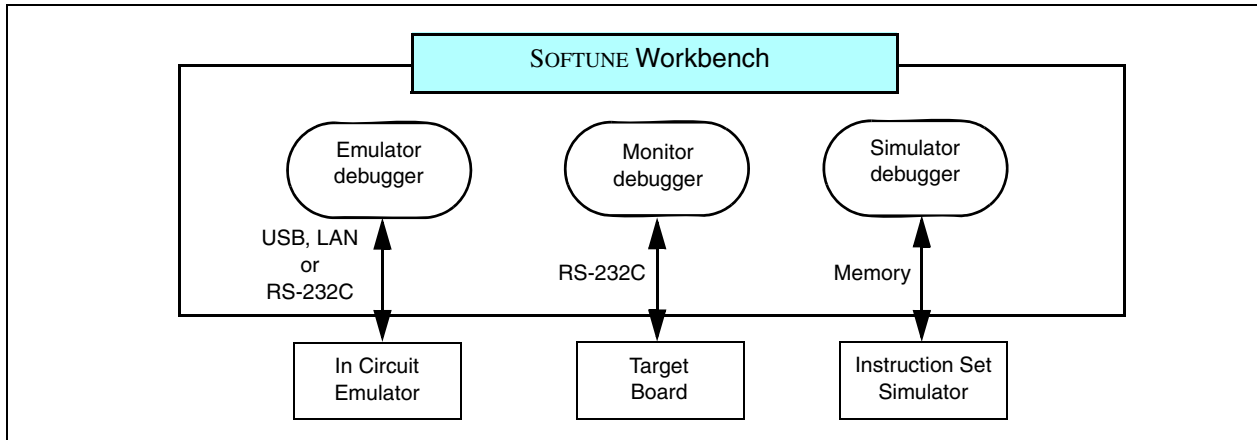

(1) Easy-to see Screen Information

The user can freely change the screen layout by selecting the necessary windows. In addition, the displayed information can be selected to provide only the information that is necessary.

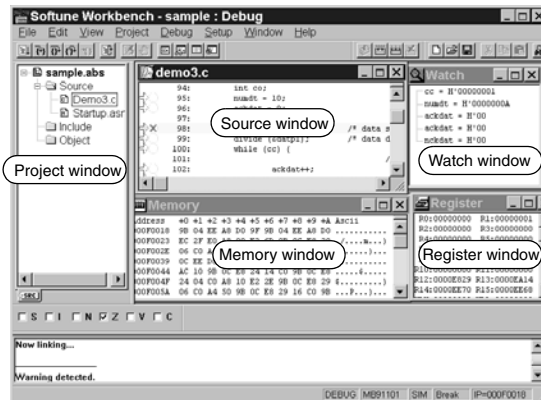

(2) Simple Environment Setting

- Debugging Environment: Setup Wizard
The setup wizard supports the selection of communication lines with emulator and boards, as well as window settings.
- MCU Operating Environment
The so-called "CPU information file," which contains the information required to support all MCUs, is provided as standard. Necessary information such as I/O port locations, ROM/RAM capacity and initial addresses can be set automatically.
- Saving and Restoring the Debugging Environment
Previous debugging environment specifications, such as window locations, breakpoint settings, and memory mapping information, are saved, so that these settings are restored the next time the program is initiated.

5. Cooperation

In cooperation with SOFTUNE Workbench, the following SOFTUNE components help improve the quality of C-language programming, which greatly increases reviewing and documentation efficiency.

1) SOFTUNE C Checker

Designed to meet the following requests from beginners through advanced users:

- Eliminate all coding mistakes.
- Review programs quickly and efficiently.
- Enable even C-language beginners to create quality code.
- Maximize coding skills.
- Use software assets on Fujitsu Microelectronics CPUs.

The SOFTUNE C Checker checks code for maintainability, methods of expanding specifications and transportability; indicates areas where quality and performance could be improved; and reports these results to the user. The user can then review the C-language code.

(1) Outline

Recent software for embedded microcontrollers has been developed in the C language. However, it is difficult to understand messages output from a compiler unless the language specifications are well known.

This development support tool checks C-source programs to display and print advice for better quality and performance. It also has a facility for selecting necessary advice carefully.

(2) Features

- Outputs advice suitable for objectives: Portability, coding error, performance, porting to Fujitsu Microelectronics CPU
- Allows customization to a programmer level.
- Works with C compilers for Fujitsu microcontrollers.
- Provides easy operation and simple display over a GUI.

(3) Advising Function

The following pieces of advice are given. “Reason of check”, “Example of program”, “Suggestion of correction”, and “One-point advice” are displayed and explained for each check item.

- Portability

This tool makes a close check on the items “processing-defined operation” and “undefined operation” which can be a problem in portability in the ANSI standard.

It also gives an explanation of the operation of C compilers (Fcc911, Fcc907 and Fcc896) for Fujitsu microcontrollers.

For example, the tool gives the user proper advice on many problems (such as a data type acceptable to a structure, code, and its arrangement at the time of porting).

- Coding error

This tool indicates the items which are not wrong in the language specifications but may cause an error and the items which are logically inconsistent.

For example, the equivalent expression “`if (a==0)`” in the if statement is likely to be typed as the assignment expression “`if (a=0)`” by mistake. Most compilers cannot detect such an error.

- Performance

This tool indicates the items which generally provide better performance and the items which are essential and effective for the FR family and F²MC-16 family.

Stress is especially, put on the detection of object size reduction which can be a problem in software for embedded microcontrollers.

For example, if a function return value is a structure of the double type, an area is reserved for the return value and an object to be transferred to the area is output.

This tool advises the user to transfer the function return value by a pointer and largely reduce the objects size.

- Porting to Fujitsu Microelectronics CUP's

This tool advises the user what to consider in porting existing software from other makers' CPU to Fujitsu Microelectronics CPU in the FR family and F²MC-16 family.

For example, in porting software resources created for the F²MC-16 family to the FR family, this tool advises the user to delete the expansion specifications (`__far`, `__near`, and `__direct` etc.) inherent to the F²MC-16 family.

- Indicated messages output

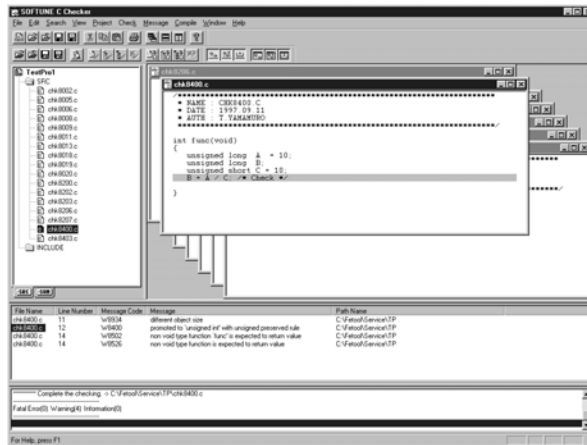

- Coding error indicated and advice displayed

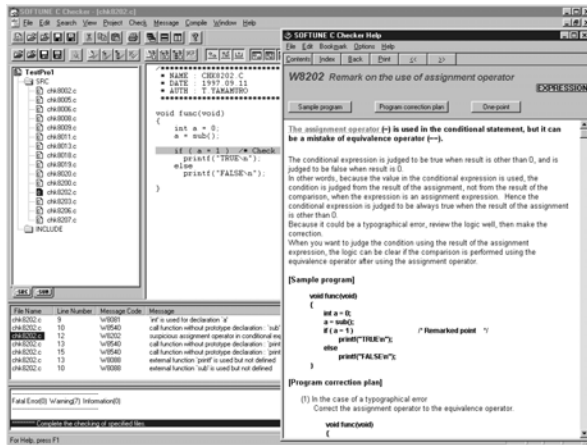

- Advice for porting to Fujitsu C compilers displayed

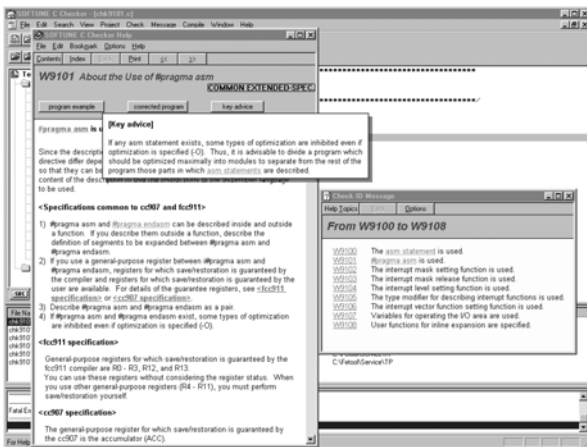

- Quality-related messages listed

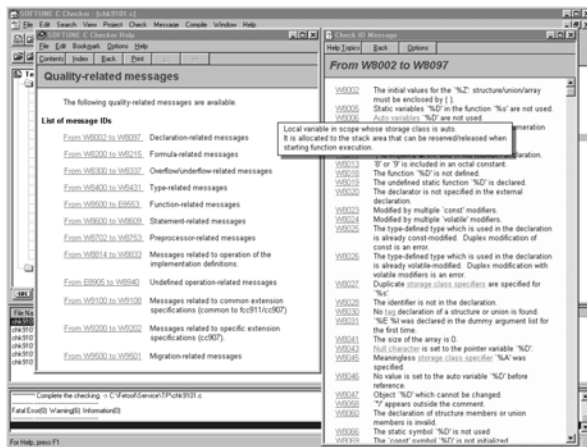

2) SOFTUNE C Analyzer

Designed to meet the following user situations:

- One wishes to examine a program's structure or processing, but the programmer is absent or documentation is unavailable.
- During program development, one wishes to create a structural program while taking into account structure and processing.
- One wishes to examine the range of effects caused by program modification.
- One wishes to create a program's internal documentation.
- One wishes to explore the possibilities of a more efficient program.

The structure and usage of data in a C-language source program are displayed visually, and the internal data structure, functional tree, stack usage and other information can be acquired and stored in a file.

(1) Outline

Recent software (ROM) for embedded microcontrollers is increasingly extending its development scale. This situation is created from development by many programmers, diversion of existing resources, and use of package programs.

This development support tool statically analyzes the C-source program to visually display and print the function-to-function structure, reference data, and statistical data. This tool creates data necessary for design and maintenance, as well as having a feature peculiar to C compilers for Fujitsu microcontrollers (a feature of calculating the maximum amount of stacks used), considering its embedded feature.

(2) Features

- Displays and prints the function-to-function structure, reference data, and statistical data.
- Supports the embedded capability of C compilers for Fujitsu microcontrollers.
- Provides easy operation and simple display over a GUI.

(3) Explanation of Features

The following data is enabled for development, maintenance, and higher porting efficiency.

- Graphic flow
This feature displays the "call" function in the block structure way. It also allows the display of the entire function and calls from any function and the retrieval of functions.
- Logic flow
This feature visually displays the internal structure of the C-source program. For example, it shapes the control structure of `for` and `switch` statements and structure declarations. A jump feature for retrieval by functions, variable, tag, and macro names is also provided.
- Displaying statistical data
This feature displays the complexity and line count of a program's every function, the source of destination function name, and the count of appearances of `if`, `for` and `asm` statements, etc.
- Displaying argument data
This feature displays data about the function-called file name and line number, the return value of the declared function, and the type of argument. It also checks the adjustability of dummy arguments with actual arguments.
- Displaying cross-reference data
This feature displays functions, variables, tag and macro declarations in its function and its line number.
- Displaying global data
This feature displays the function using global variables. It also detects unused global variables.
- Program checking
This feature checks and displays the adjustability of dummy arguments with actual arguments.
- Calculating the maximum amount of stacks used
This feature calculates and displays the amount of stacks used in the entire function, as well as in any function. This calculation is made on the basis of the output of C compilers (Fcc911s, Fcc907s and Fcc896s) for Fujitsu microcontrollers (FR family, F²MC-16 family and F²MC-8L family).

16-bit Proprietary F²MC-16LX Family Support Tools

- Displaying graphic flow

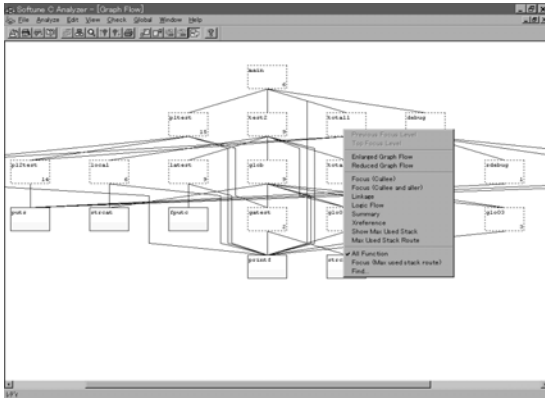

- Displaying logic flow, statistical and cross-reference data

Line	Column	Row	Column	Type	Line	Column	Row	Column
00130	void glob()	00130	0	function definition	glob	00130	0	0
00131	{	00131	1	block start		00131	1	1
00132	int i;	00132	1	variable	i	00132	1	1
00133	{	00133	1	block start		00133	1	1
00134	strcpy(s,a);	00134	1	function call	strcpy	00134	1	1
00135	strcpy(s,a);	00135	1	function call	strcpy	00135	1	1
00136	while (s[i]!='\0')	00136	1	while loop		00136	1	1
00137	printf("%s\n",s);	00137	1	function call	printf	00137	1	1
00138	++i;	00138	1	increment		00138	1	1
00139	printf("xxxx %d\n",s[i]);	00139	1	function call	printf	00139	1	1
00140	return s;	00140	1	return statement		00140	1	1
00141	}	00141	1	block end		00141	1	1
00142	glob1();	00142	1	function call	glob1	00142	1	1
00143	glob2();	00143	1	function call	glob2	00143	1	1
00144	glob3();	00144	1	function call	glob3	00144	1	1
00145	}	00145	1	block end		00145	1	1
00146	}	00146	1	function end		00146	1	1
00147		00147	1			00147	1	1
00148	void sdbuu1(outs"sdbuu\n");	00148	0	function definition	sdbuu1	00148	0	0
00149	{	00149	1	block start		00149	1	1
00150	void sdbuu1(outs"sdbuu\n");	00150	1	function call	sdbuu1	00150	1	1
00151	}	00151	1	block end		00151	1	1
00152		00152	1			00152	1	1
00153	void sdbuu2(s)	00153	0	function definition	sdbuu2	00153	0	0
00154	{	00154	1	block start		00154	1	1
00155	printf("xxxx %d\n",s);	00155	1	function call	printf	00155	1	1
00156	}	00156	1	block end		00156	1	1
00157		00157	1			00157	1	1
00158		00158	1			00158	1	1
00159	}	00159	1	function end		00159	1	1

- Displaying logic flow (focus), argument and global data

Name	Type	Function name
i	char [255]	test2
s	char *	test2
sdb_u1	char *	test2
sdb_u2	char *	test2
sdb_u3	char *	test2

- Displays stack use volume (green numbers) and largest stack configuration (orange numbers)

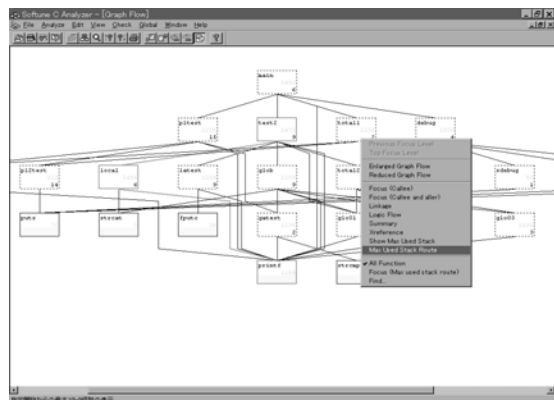

6. μ ITRON-Compliant Real Time OS for F²MC-16LX Family (SOFTUNE REALOS/907)

(1) Overview

REALOS/907 is the real time OS for the F²MC-16LX family of Fujitsu Microelectronics proprietary 16-bit MCUs, conforming to the μ ITRON 2.01 specifications.

• Features

- μ ITRON Ver.2.01 Specifications
- System design customized for 16-bit MCUs for control purposes
- In-line expansion of system call functions
- High-speed interrupt processing
- Providing a sample program
- Support for REALOS configurator
- Support for REALOS analyzer

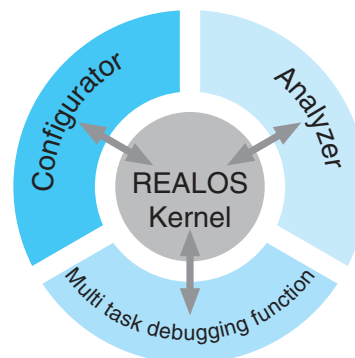

• REALOS/907 specifications

Name	Description
Target CPU	F ² MC-16LX family
Maximum number of task	255
Maximum number of priority levels	16
Scheduling method	Priority-base, event-driven type
Number of system calls	46
Complying specifications	μ ITRON 2.01 specifications
Kernel coding	Assembly language
Application coding	C and assembly languages
Kernel size	About 0.8 KB (resident) to about 5.9 KB (maximum configuration)

16-bit Proprietary F²MC-16LX Family Support Tools

(2) Configuration

• Kernel

The kernel of the real time OS provides its basic functions. It is an event-driven, multitasking real time OS. The functions to be used by application programs can be selected as system calls.

• System calls

Function	Instruction	Description
Task management functions	sta_tsk ext_tsk ter_tsk chg_pri rot_rdq get_tid tsk_sts	Start task Exit local task successfully Terminate remote task forcibly Change task priority Rotate task ready queue Get local task ID Reference task status
Task-supplied synchronization functions	sus_tsk rsm_tsk frsm_tsk slp_tsk wai_tsk wup_tsk can_wup	Move the task to the suspended state Resume the task in the suspended state Forcibly resume the task in the suspended state Move the task into the wait state Move the task into the wait state for a given time Wake up the task in the wait state Cancel the walk-up request of the task
Synchronization/transmission functions	set_flg set_flg clr_flg clr_flg wai_flg wai_flg cwai_flg pol_flg pol_flg cpol_flg flg_sts sig_sem wai_sem preq_sem sem_sts snd_msg rcv_msg prcv_msg mbx_sts	Set a single-bit event flag Set a single-word event flag Clear a single-bit event flag Clear a single-word event flag Wait for a single-bit event flag (no clear) Wait for a single-word event flag Wait for a single-bit event flag (clear) Poll a single-bit event flag (no clear) Poll a single-word event flag Poll a single-bit event flag (clear) Reference event flag status Signal operation to the semaphore (V instruction) Wait operation to the semaphore (P instruction) Poll and request the semaphore resources Reference the semaphore status Send data to the mailbox Wait for the receive from the mailbox Poll and receive message from the mailbox Reference the mailbox status
Interrupt management function	ret_int ret_wup chg_ilv ilv_sts	Return from interrupt handler Return to the interrupt processing for task walk-up Change the interrupt level Reference the interrupt level status
Memory pool management functions	get_blk pget_blk rel_blk mpl_sts	Wait for the receiving of the fixed length memory block Poll and get fixed length memory block Release the fixed length memory block Reference the memory pool status
Time management functions	set_tim get_tim def_cyc act_cyc cyh_sts def_alm alh_sts ret_tmr	Set system clock Reference system clock Define cyclic handler Activate/control cyclic handler Reference cyclic handler status Define alarm handler Reference alarm handler status Return from timer handler
System management function	get_ver	Get version number

• REALOS Configurator

The configurator helps when setting conditions for creating the REALOS kernel, Necessary settings are made according to the display on the configurator screen, simplifying kernel configuration.



• REALOS Analyzer

The performance of the system by which REALOS is built in and the state transition of the task are analyzed and displayed by Graphic.

- Displaying object conditions
- OS break (execution break, access break, dispatcher break, service call/system call break)
- Issuing a service call/system call
- Task transition flow
- Stack status
- Task context watch

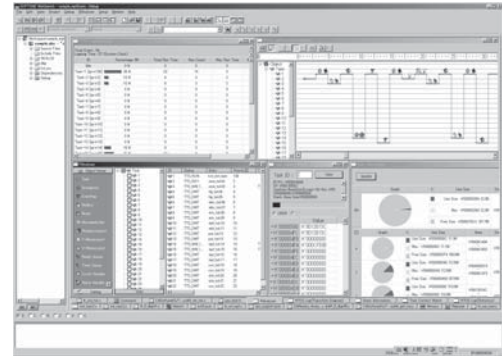

SOFTUNE V3 Support Software Product List

Software		Part number *1 (Maintenance number)	Remarks
Pack Products	SOFTUNE V3 Professional Pack	SP3607Z008-P01 (SP3607Z008-P01-M)	SOFTUNE V3 workbench SOFTUNE V3 C compiler SOFTUNE V3 assembler pack SOFTUNE V3 analyzer set SOFTUNE V3 checker
Individual Products	SOFTUNE V3 OSEK analyzer	SP360831918QAC (—)	Analysis tool for OSEK Vector Japan Co., Ltd and Elektrobit Corporation.
	Real time OS SOFTUNE V3 REALOS/907 basic	SP3607M008BA (SP3607M008BA-M)	μITRON Ver.2.01 Specifications Kernel (source code provided) Configurator, analyzer Licence free
	Real time OS SOFTUNE V3 REALOS/907 evaluation	SP3607M008EV (—)	μITRON Ver.2.01 Specifications Kernel (no source code) Configurator, analyzer For evaluation
Compatible emulator hardware		MB2147 series - MB2147-01 - MB2147-10/20	—
Personal computers	Operating machine	FMV and similar IBM compatibles	—
	Operating OS *3	WindowsXP Windows2000	—
	Media	CD-ROM *2	—

*1: The product code suffix (Pxx) indicates the number of licenses. Licensing of each product is available in a number of forms (3, 5 or 1 0copies).

The part number is an ordered number of the newest version.

Please contact us if purchasing the previous version as a different part is used.

*2: An electronic manual (PDF format) is provided with each product (Japanese and English). Printed manuals are sold separately.

*3: Operating OS corresponds to Japanese and English.

F²MC-16LX Family Evaluation Tools (MB2147-01 High speed version)

Features

- Microcontroller operating frequency: max 33 MHz
- Microcontroller operating voltage: +2.7V to +5.5V
The range (Max. and Min.) of Microcontroller operating voltage and operating frequency depend on each Microcontroller. See the document including Data Sheet and check the range of Microcontroller operating voltage and operating frequency.
- Emulation memory: 1 M × 4 area
- Supports debugging of source level (assembly and C languages, a mixed indication)
- Simplified graphic interface operation execution using pull-down menu and buttons
- On-The-Fly function (commands can be run during microcontroller execution)
- Powerful real time trace function
- Displays source codes, variables, register, memory and trace on multi windows
- Event trigger allows a wide range of conditions to be specified (code × 8 / data × 8)
- Sequential control in 4 conditions and 3 levels
- Performance measurement function (measurement of execution speed between two points, iteration count measurement)
- C₀ coverage measurement function (program execution coverage rate measurement)
- Host I/F (standard accessories) : RS-232C (max 115 Kbps) , LAN (10BASE-T, 100BASE-TX) , USB 1.1

System Overview



System configuration

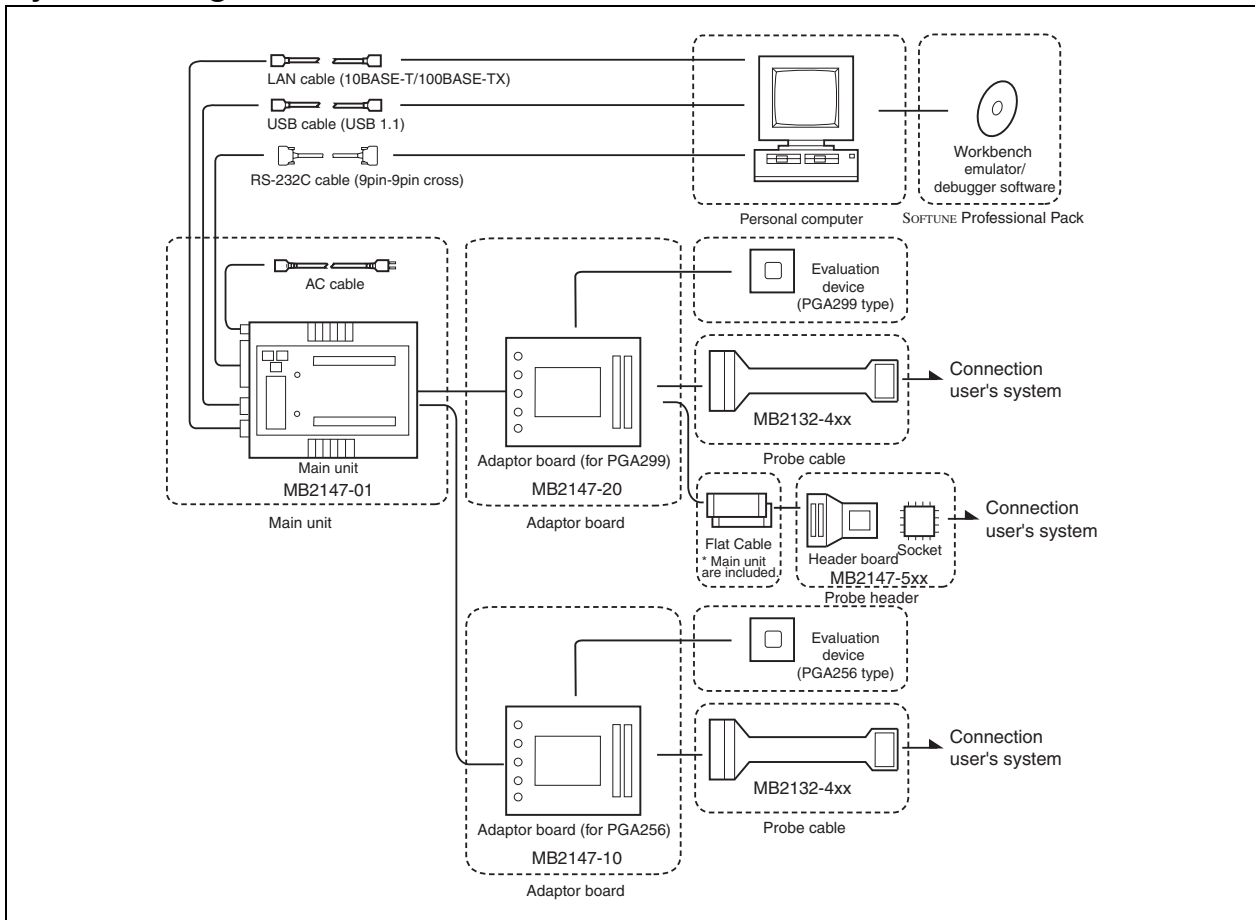

16-bit Proprietary F²MC-16LX Family Support Tools

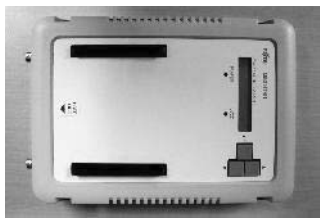
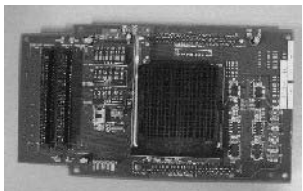
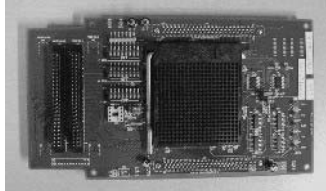
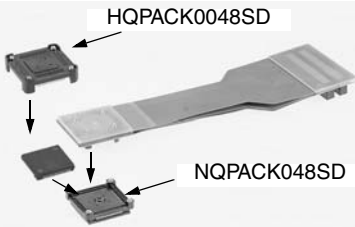
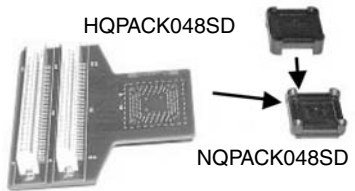
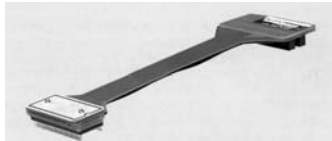
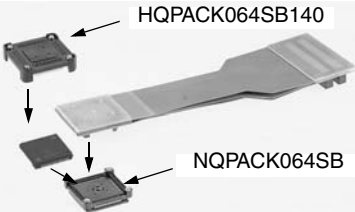
Name	Part number	Remarks	Overview
High speed version main unit	MB2147-01	For all F ² MC-16LX family. (evaluation device: PGA256, PGA299) Power supply voltage: AC100V or AC200V Host I/F: RS-232C, LAN (10BASE-T, 100BASE-TX), USB 1.1 Dimensions: W150 × D210 × H46 mm Weight: 1.0 kg Includes: manual, AC cable × 1, flat cable(10/20cm) × 2	
Adaptor board (evaluation device : for PGA256)	MB2147-10	For F ² MC-16LX family (evaluation device: for PGA256) Dimensions: W110 × D199 × H20 mm Weight: 0.2 kg	
High speed version adaptor board (evaluation device : for PGA299)	MB2147-20	For F ² MC-16LXfamily high speed type (evaluation device: for PGA299) For MB90340E/350E/390/480/800/820/860E/880 series Dimensions: W110 × D199 × H20 mm Weight: 0.2 kg Includes: manual	
Probe cable	For LQFP-48 0.5mm pitch □7 × 7 mm	For MB90385 series. Package code: FPT-48P-M26 Includes: - NQPACK048SD, HQPACK048SD *3 NQPACK048SD enables probe cable connection and mounted IC evaluation. - manual	
	For SH-DIP-64	For MB90360E series, MB90960 series Package code: FPT-48P-M26 Includes: - NQPACK048SD, HQPACK048SD *3 NQPACK048SD enables probe cable connection and mounted IC evaluation. - manual	
	For SH-DIP-64	For MB90460/560 series Package code: DIP-64P-M01 Includes: manual	
	For LQFP-64 0.65 mm pitch □12 × 12 mm	For MB90460/495/560/565 series Package code: FPT-64P-M09 Includes: - NQPACK064SB, HQPACK064SB140 *3 NQPACK064SB enables probe cable connection and mounted IC evaluation. - manual	

(Continued)

16-bit Proprietary F²MC-16LX Family Support Tools

(Continued)

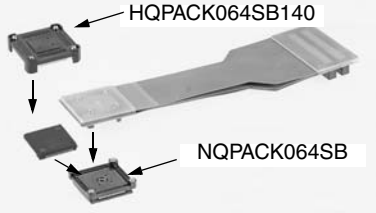
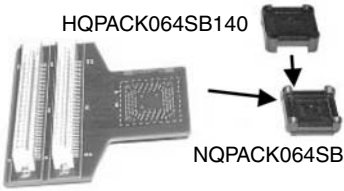
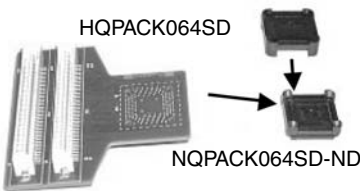
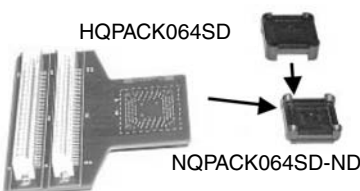
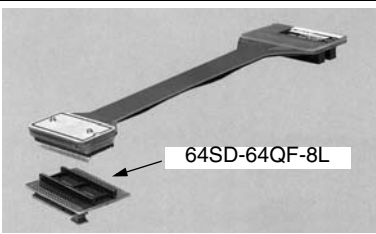
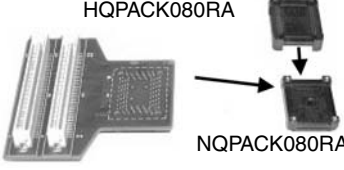
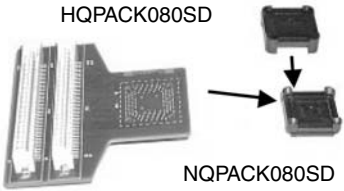
Name	Part number	Remarks	Overview	
Probe cable	For LQFP-64 0.65 mm pitch □12 × 12 mm	MB2132-493	For MB90335 series Package code: FPT-64P-M09 Includes: - NQPACK064SB, HQPACK064SB140 *3 NQPACK064SB enables probe cable connection and mounted IC evaluation. - manual	
		MB2147-540	For MB90350E series Package code: FPT-64P-M09 Includes: - NQPACK064SB, HQPACK064SB140 *3 NQPACK064SB enables probe cable connection and mounted IC evaluation. - manual	
	For LQFP-64 0.5 mm pitch □10 × 10mm	MB2147-541	For MB90980 series Package code: FPT-64P-M03 Includes: - NQPACK064SD-ND, HQPACK064SD NQPACK064SD-ND enables probe cable connection and mounted IC evaluation. - manual	
		MB2147-542	For MB90350E series Package code: FPT-64P-M24 Includes: - NQPACK064SD-ND, HQPACK064SD NQPACK064SD-ND enables probe cable connection and mounted IC evaluation. - manual	
	For QFP-64 1.0 mm pitch □14 × 20mm	MB2132-434	For MB90460/495G/560/565 series Package code: FPT-64P-M06 Conversion adapter (64SD-64QF-8L) is separately required. *2 Made by Sunhayato Corp. Includes: manual	
	For QFP-80 0.8 mm pitch □14 × 20 mm	MB2147-560	For MB90820 series Package code: FPT-80P-M06 Includes: - NQPACK080RA, HQPACK080RA *3 NQPACK080RA enables probe cable connection and mounted IC evaluation. - manual	
	For LQFP-80 0.5 mm pitch □12 × 12 mm	MB2147-561	For MB90820 series Package code: FPT-80P-M05 Includes: - NQPACK080SD, HQPACK080SD *3 NQPACK080SD enables probe cable connection and mounted IC evaluation. - manual	

(Continued)

16-bit Proprietary F²MC-16LX Family Support Tools

(Continued)

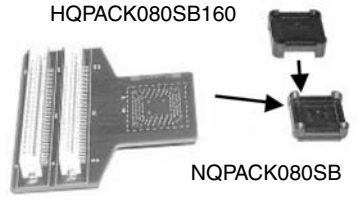
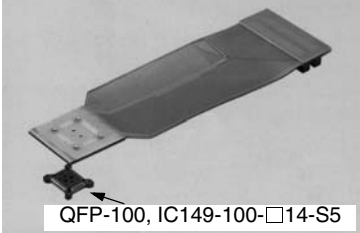
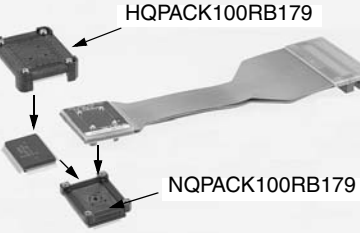
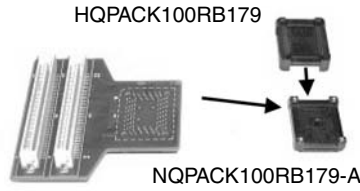
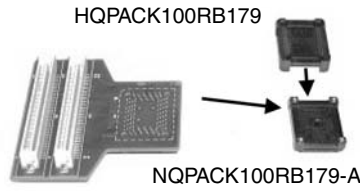
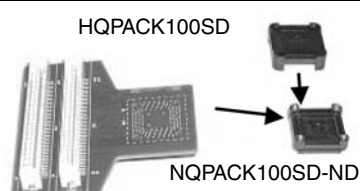
		Name	Part number	Remarks	Overview
Probe cable	For LQFP-80 0.65 mm pitch □14 × 14 mm		MB2147-562	For MB90820 series Package code: FPT-80P-M11 Includes: - NQPACK080SB, HQPACK080SB160 *3 NQPACK080SB enables probe cable connection and mounted IC evaluation. - manual	 HQPACK080SB160 NQPACK080SB
	For QFP-100 0.65 mm pitch □14 × 20 mm		MB2132-457	For MB904xx/5xx/6xx series Package code: FPT-100P-M06 IC149-100-□14-B5 is separately required. *1 Support power supply one system. Not support power supply two systems. Made by Yamaichi Electronics Inc. Includes: manual	 QFP-100, IC149-100-□14-S5
			MB2132-464	For MB904xx/5xx/6xx series Package code: FPT-100P-M06 Includes: - NQPACK100RB179-A, HQPACK100RB 179 *3 NQPACK100RB179 enables probe cable connection and mounted IC evaluation. Support power supply one system and two systems. - manual	 HQPACK100RB179 NQPACK100RB179
			MB2147-582	For MB90340E/800/880 series Package code: FPT-100P-M06 Includes: - NQPACK100RB179-A, HQPACK100RB 179 *3 NQPACK100RB179 enables probe cable connection and mounted IC evaluation. - manual	 HQPACK100RB179 NQPACK100RB179-A
			MB2147-583	For MB90945 series Package code: FPT-100P-M06 Includes: - NQPACK100RB179-A, HQPACK100RB 179 *3 NQPACK100RB179 enables probe cable connection and mounted IC evaluation. - manual	 HQPACK100RB179 NQPACK100RB179-A
		For LQFP-100 0.5 mm pitch □14 × 14 mm		MB2147-581	For MB90340E/880 series Package code: FPT-100P-M05 Includes: - NQPACK100SD-ND, HQPACK100SD *3 NQPACK100SD-ND enables probe cable connection and mounted IC evaluation. - manual
			MB2147-584	For MB90945 series Package code: FPT-100P-M05 Includes: - NQPACK100SD-ND, HQPACK100SD *3 NQPACK100SD-ND enables probe cable connection and mounted IC evaluation. - manual	 HQPACK100SD NQPACK100SD-ND

(Continued)

16-bit Proprietary F²MC-16LX Family Support Tools

(Continued)

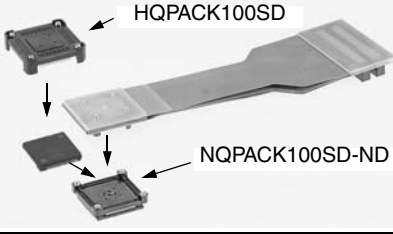
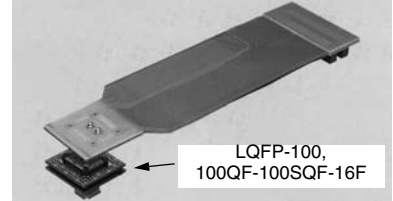
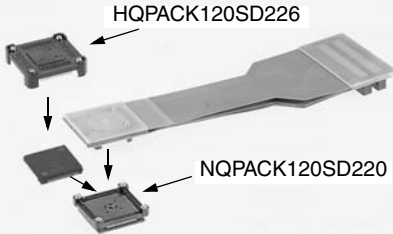
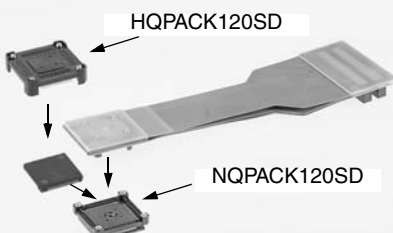
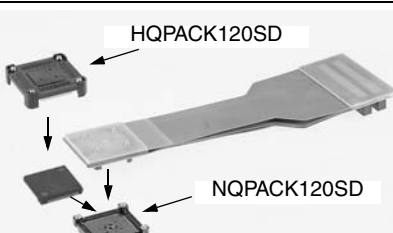
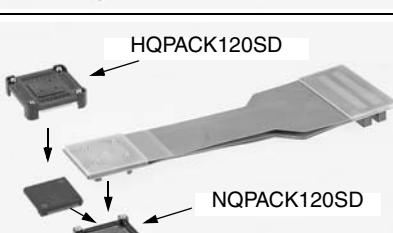
Name	Part number	Remarks	Overview
Probe cable	For LQFP-100 0.5 mm pitch □14 × 14 mm	MB2132-496 For MB904xx/5xx/6xx series Package code: FPT-100P-M05 Includes: - NQPACK100SD-ND, HQPACK100SD * ³ NQPACK100SD-ND enables probe cable connection and mounted IC evaluation. - manual	
	For LQFP-100 0.5 mm pitch □14 × 14 mm	MB2132-457 For MB904xx/5xx/6xx series Package code: FPT-100P-M05 Conversion adapter (100QF-100SQF-16F) is separately required.* ² Made by Sunhayato Corp. Support power supply one system. Not support power supply two systems. Includes: manual	
	For QFP-120 0.5 mm pitch □20 × 20 mm	MB2132-468 For MB90520/570 series Package code: FPT-120P-M13 Includes: - NQPACK120SD220 and HQPACK120SD226 are included. * ³ NQPACK120SD220 enables probe cable connection and mounted IC evaluation. - manual	
	For QFP-120 0.5 mm pitch □16 × 16 mm	MB2132-497 For MB90570 series Package code: FPT-120P-M21 Includes: - NQPACK120SD, HQPACK120SD * ³ NQPACK120SD enables probe cable connection and mounted IC evaluation. - manual	
	For QFP-120 0.5 mm pitch □16 × 16 mm	MB2132-469 For MB90390 series, MB90920 series Package code: FPT-120P-M21 Includes: - NQPACK120SD, HQPACK120SD * ³ NQPACK120SD enables probe cable connection and mounted IC evaluation. - manual	
		MB2132-492 For MB90330A series Package code: FPT-120P-M21 Includes: - NQPACK120SD, HQPACK120SD * ³ NQPACK120SD enables probe cable connection and mounted IC evaluation. - manual	

(Continued)

16-bit Proprietary F²MC-16LX Family Support Tools

(Continued)

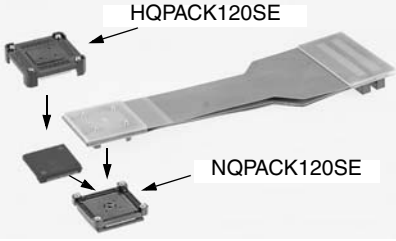
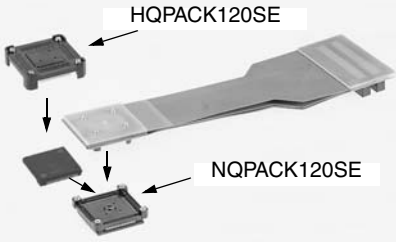
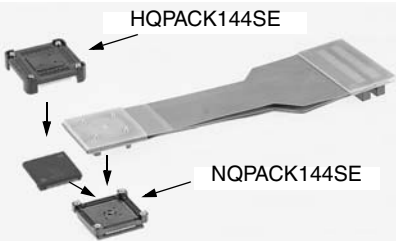
Name		Part number	Remarks	Overview
Probe cable	For LQFP-120 0.4 mm pitch □14 × 14 mm	MB2132-498	For MB90520/570 series Package code: FPT-120P-M05 Includes: - NQPACK120SE, HQPACK120SE *3 NQPACK120SE enables probe cable connection and mounted IC evaluation. - manual	
	For LQFP-120 0.4 mm pitch □14 × 14 mm	MB2132-491	For MB90330A series Package code: FPT-120P-M05 Includes: - NQPACK120SE, HQPACK120SE *3 NQPACK120SE enables probe cable connection and mounted IC evaluation. - manual	
	For LQFP-144 0.4 mm pitch □16 × 16 mm	MB2132-471	For MB90370/375/378 series Package code: FPT-144P-M12 Includes: - NQPACK144SE, HQPACK144SE *3 NQPACK144SE enables probe cable connection and mounted IC evaluation. - manual	

*1: The probe cable requires an IC socket from Yamaichi Electronics Inc.

For QFP-100 (lead pitch: 0.65 mm, body size: 14 × 20 mm): IC149-100-□14-B5 (□ = "0": No positioning post, □ = "1": positioning post provided)
Contact for details:

•USA:	Denmark:	Yamaichi Electronics Inc. TEL(408)4520797
•Europe	England:	Elmatok A.S. TEL(65)351446
		Radiatron Components Ltd. TEL(01)8911221
		AB Connector Ltd. TEL(0604)712000
	Finland:	Dualtek Oy TEL(80)8019911
	France:	Manudax-France TEL(1)4342-2050
	Germany:	Macrotran AG TEL(089)4208148
		Glyn GmbH TEL(49)61278077
		Connector Service GmbH TEL(089)429277
	Italy:	Eurosab International s.r.l TEL(02)93169781
	Spain:	S.A Generalde Imporciones Electronicas TEL(1)416-92-61
	Sweden:	Bexab Electronics TEL(08)7680560
	Switzerland:	Slcovend AG TEL(01)8303161
•Asia	Singapore:	Yamco Electronics Pte Ltd. TEL(336)6522
	Korea:	Asia Yamaichi Electronics, Inc. TEL(02)482-7263
	Taiwan:	Sing Way Co. TEL(02)718-5971
		Joung Lai Trading Co. Ltd. TEL(02)754-1022

*2: The probe cable requires a conversion adapter from Sunhayato Corp.

Conversion adapter for LQFP-100: QFP-100 (0.65 mm, 14 × 20 mm) → LQFP-100 (0.5 mm, 14 × 14 mm, product no. 100QF-100SQF-16F)

Conversion adapter for LQFP-64: SH-DIP-64 → LQFP-64 (0.65 mm, 12 × 12 mm, product no. 64SD-64QF2-8L)

Conversion adapter for QFP-64 (lead pitch: 1.0 mm): SH-DIP-64 → QFP-64 (1.0 mm, 14 × 20 mm, product no. 64SD-64QF-8L)

Contact for details: Tokyo Japan: Sunhayato Corp. TEL +81-3-3984-7791, FAX +81-3-3971-0535

*3: The probe cable requires TQ-pack or NQ-pack.

Note: Care is required in printed circuit board pattern design because the position of the board connector part (the flat section at the pin tips) of the TQ-pack differs from the mass production product package (the NQ-pack pins are shifted a few millimeters inwards).

Contact for details:

•USA:		OESS Co. San Jose Office TEL(408)437-1582
•Europe	Germany:	OESS GmbH TEL(06106)2857890
	Tokyo Eletech Co, Ltd.	TEL(81)3-3820-7141

16-bit Proprietary F²MC-16LX Family Support Tools

Evaluation Tools

MB90330A series

[Hardware]

Name	Part number	Description	Remarks
Main unit	MB2147-01	High speed version In Circuit Emulator	-
Adapter board	MB2147-20	High speed version For PGA299	-
Evaluation Device	MB90V330ACR-ES	PGA-299C	-
Probe cable	MB2132-491	For LQFP-120 (0.4 mm, 14 × 14 mm) FPT-120P-M05	Selectable
	MB2132-492	For LQFP-120 (0.5 mm, 16 × 16 mm) FPT-120P-M21	
PC cable	LAN cable	10BASE-T/100BASE-TX	Selectable
	USB cable	USB1.1	
	RS-232C cable	9pin-9pin cross cable	
Evaluation board for USB	MB2031-01	Evaluation board	Option
	MB2031-20	Daughter board For LQFP-120 (0.4 mm, 14 × 14 mm)	

[Software]

Software	Part number	Operating System
SOFTUNE V3 Professional Pack	SP3607Z008-P01	WindowsXP/2000

[Flash microcontroller for programming]

Flash microcontroller	Package	Parallel programmer	Serial on board programmer
		Flash Support Group, Inc. AF9708/AF9709/AF9723	Yokogawa Digital Computer Corporation
MB90F334A	LQFP-120 (0.4 mm, 14 × 14 mm) FPT-120P-M05	(Under development)	AF220/AF210 AF120/AF110
	LQFP-120 (0.5 mm, 16 × 16 mm) FPT-120P-M21	(Under development)	

16-bit Proprietary F²MC-16LX Family Support Tools

MB90335 series

[Hardware]

Name	Part number	Description	Remarks
Main unit	MB2147-01	High speed version In Circuit Emulator	-
Adapter board	MB2147-20	High speed version For PGA299	-
Evaluation Device	MB90V330ACR-ES	PGA-299C	-
Probe cable	MB2132-493	For LQFP-64 (0.65 mm, 12 × 12 mm) FPT-64P-M09	-
PC cable	LAN cable	10BASE-T/100BASE-TX	Selectable
	USB cable	USB1.1	
	RS-232C cable	9pin-9pin cross cable	

[Software]

Software	Part number	Operating System
SOFTUNE V3 Professional Pack	SP3607Z008-P01	WindowsXP/2000

[Flash microcontroller for programming]

Flash microcontroller	Package	Parallel programmer	Serial on board programmer
		Flash Support Group, Inc. AF9708/AF9709/AF9723	Yokogawa Digital Computer Corporation
MB90F337	LQFP-64 (0.65 mm, 12 × 12 mm) FPT-64P-M09	TEF110-337F31AP	AF220/AF210 AF120/AF110

16-bit Proprietary F²MC-16LX Family Support Tools

MB90340E series

[Hardware]

Name	Part number	Description	Remarks
Main unit	MB2147-01	High speed version In Circuit Emulator	-
Adapter board	MB2147-20	High speed version For PGA299	-
Evaluation Device	MB90V340E-101CR-ES	Single clock, PGA-299C	Selectable
	MB90V340E-102CR-ES	Dual clock, PGA-299C	
Probe cable	MB2147-581	For LQFP-100 (0.5 mm, 14 × 14 mm) FPT-100P-M05	Selectable
	MB2147-582	For QFP-100 (0.65 mm, 14 × 20 mm) FPT-100P-M06	
PC cable	LAN cable	10BASE-T/100BASE-TX	Selectable
	USB cable	USB1.1	
	RS-232C cable	9pin-9pin cross cable	
Evaluation board	BBF2004-MB	Main board Sunhayato	Option
	BBF2001-100CL2-NB	Daughter board Sunhayato For QFP-100	

[Software]

Software	Part number	Operating System
SOFTUNE V3 Professional Pack	SP3607Z008-P01	WindowsXP/2000

[Flash microcontroller for programming]

Flash microcontroller		Package	Parallel programmer	Serial on board programmer	
			Flash Support Group, Inc. AF9708/AF9709/ AF9723	Yokogawa Digital Computer Corporation	Flash Support Group, Inc.
MB90F342EPFV MB90F342ESPFV MB90F342CEPFV MB90F342CESPFV MB90F343EPFV MB90F343ESPFV MB90F343CEPFV MB90F343CESPFV MB90F345EPFV MB90F345ESPFV MB90F345CEPFV MB90F345CESPFV	MB90F346EPFV MB90F346ESPFV MB90F346CEPFV MB90F346CESPFV MB90F347EPFV MB90F347ESPFV MB90F347CEPFV MB90F347CESPFV MB90F349EPFV MB90F349ESPFV MB90F349CEPFV MB90F349CESPFV	LQFP-100 (0.5mm, 14 × 14mm) FPT-100P-M05	TEF110-328F13AP-2	AF220/AF210 AF120/AF110	AF9101 (Under planning excluding MB90F347)
MB90F342EPF MB90F342ESPF MB90F342CEPF MB90F342CESPF MB90F343EPF MB90F343ESPF MB90F343CEPF MB90F343CESPF MB90F345EPF MB90F345ESPF MB90F345CEPF MB90F345CESPF	MB90F346EPF MB90F346ESPF MB90F346CEPF MB90F346CESPF MB90F347EPF MB90F347ESPF MB90F347CEPF MB90F347CESPF MB90F349EPF MB90F349ESPF MB90F349CEPF MB90F349CESPF	QFP-100 (0.65mm, 14 × 20mm) FPT-100P-M06	TEF110-328F12AP-2		

16-bit Proprietary F²MC-16LX Family Support Tools

MB90350E series

[Hardware]

Name	Part number	Description	Remarks
Main unit	MB2147-01	High speed version In Circuit Emulator	-
Adapter board	MB2147-20	High speed version For PGA299	-
Evaluation Device	MB90V340E-101CR-ES	Single clock, PGA-299C(90351/352)	Selectable
	MB90V340E-102CR-ES	Dual clock, PGA-299C(90351/352)	
	MB90V340E-103CR-ES	Single clock, PGA-299C(90356/357)	
	MB90V340E-104CR-ES	Dual clock, PGA-299C(90356/357)	
Probe cable	MB2147-540	For LQFP-64 (0.65 mm, 12 × 12 mm) FPT-64P-M09	Selectable
	MB2147-542	For LQFP-64 (0.5 mm, 10 × 10 mm) FPT-64P-M24	
PC cable	LAN cable	10BASE-T/100BASE-TX	Selectable
	USB cable	USB1.1	
	RS-232C cable	9pin-9pin cross cable	
Evaluation board	BBF2004-MB	Main board Sunhayato	Option
	BBF2004-64CL-NB	For LQFP-64 Daughter board Sunhayato	

[Software]

Software	Part number	Operating System
SOFTUNE V3 Professional Pack	SP3607Z008-P01	WindowsXP/2000

[Flash microcontroller for programming]

Flash microcontroller	Package	Parallel programmer	Serial on board programmer
		Flash Support Group, Inc. AF9708/AF9709/AF9723	Yokogawa Digital Computer Corporation
MB90F351E MB90F351ES MB90F351TE MB90F351TES MB90F352E MB90F352ES MB90F352TE MB90F352TES MB90F356E MB90F356ES MB90F356TE MB90F356TES MB90F357E MB90F357ES MB90F357TE MB90F357TES	LQFP-64 (0.65 mm, 12 × 12 mm) FPT-64P-M23	TEF110-352F30AP	AF220/AF210 AF120/AF110
	LQFP-64 (0.5 mm, 10 × 10 mm) FPT-64P-M24	TEF110-90F352A	

16-bit Proprietary F²MC-16LX Family Support Tools

MB90360E series

[Hardware]

Name	Part number	Description	Remarks
Main unit	MB2147-01	High speed version In Circuit Emulator	-
Adapter board	MB2147-20	High speed version For PGA299	-
Evaluation Device	MB90V340E-101CR-ES	Single clock, PGA-299C(MB90362)	Selectable
	MB90V340E-102CR-ES	Dual clock, PGA-299C(MB90362)	
	MB90V340E-103CR-ES	Single clock, PGA-299C(MB90367)	
	MB90V340E-104CR-ES	Dual clock, PGA-299C(MB90367)	
Probe cable	MB2147-521	For LQFP-48 (0.5 mm, 7 × 7 mm) FPT-48P-M26	-
PC cable	LAN cable	10BASE-T/100BASE-TX	Selectable
	USB cable	USB1.1	
	RS-232C cable	9pin-9pin cross cable	

[Software]

Software	Part number	Operating System
SOFTUNE V3 Professional Pack	SP3607Z008-P01	WindowsXP/2000

[Flash microcontroller for programming]

Flash microcontroller	Package	Parallel programmer	Serial on board programmer	
		Flash Support Group, Inc. AF9708/AF9709/AF9723	Yokogawa Digital Computer Corporation	Flash Support Group, Inc.
MB90F362EPMT MB90F362TEPMT MB90F362ESPMT MB90F362TESPMT MB90F367EPMT MB90F367TEPMT MB90F367ESPMT MB90F367TESPMT	LQFP-48 (0.5 mm, 7 × 7 mm) FPT-48P-M26	TEF110-387F15AP-2	AF220/AF210 AF120/AF110	AF9101

16-bit Proprietary F²MC-16LX Family Support Tools

MB90370/375 series

[Hardware]

Name	Part number	Description	Remarks
Main unit	MB2147-01	High speed version In Circuit Emulator	-
Adapter board	MB2147-10	For PGA256	-
Evaluation Device	MB90V370CR-ES	PGA-256C	-
Probe cable	MB2132-471	For LQFP-144 (0.4 mm, 16 × 16 mm) FPT-144P-M12	-
PC cable	LAN cable	10BASE-T/100BASE-TX	Selectable
	USB cable	USB1.1	
	RS-232C cable	9pin-9pin cross cable	
Evaluation board	(Not supported)	Main board	Option
	(Not supported)	Daughter board	

[Software]

Software	Part number	Operating System
SOFTUNE V3 Professional Pack	SP3607Z008-P01	WindowsXP/2000

[Flash microcontroller for programming]

Flash microcontroller	Package	Parallel programmer	Serial on board programmer
		Flash Support Group, Inc. AF9708/AF9709/AF9723	Yokogawa Digital Computer Corporation
MB90F372 MB90F377	LQFP-144 (0.4 mm, 16 × 16 mm) FPT-144P-M12	TE110-372F17AP	(Not supported)

MB90378 series

[Hardware]

Name	Part number	Description	Remarks
Main unit	MB2147-01	High speed version In Circuit Emulator	-
Adapter board	MB2147-20	For PGA299	-
Evaluation Device	MB90V378CR-ES	PGA-299C	-
Probe cable	MB2132-471	For LQFP-144 (0.4 mm, 16 × 16 mm) FPT-144P-M12	-
PC cable	LAN cable	10BASE-T/100BASE-TX	Selectable
	USB cable	USB1.1	
	RS-232C cable	9pin-9pin cross cable	
Evaluation board	(Not supported)	Main board	Option
	(Not supported)	Daughter board	

[Software]

Software	Part number	Operating System
SOFTUNE V3 Professional Pack	SP3607Z008-P01	WindowsXP/2000

[Flash microcontroller for programming]

Flash microcontroller	Package	Parallel programmer	Serial on board programmer
		Flash Support Group, Inc. AF9708/AF9709/AF9723	Yokogawa Digital Computer Corporation
MB90F378	LQFP-144 (0.4 mm, 16 × 16 mm) FPT-144P-M12	TE110-372F17AP-2	(Not supported)

16-bit Proprietary F²MC-16LX Family Support Tools

MB90385 series

[Hardware]

Name	Part number	Description	Remarks
Main unit	MB2147-01	High speed version In Circuit Emulator	-
Adapter board	MB2147-10	For PGA256	-
Evaluation Device	MB90V495GCR-ES	PGA-256C	-
Probe cable	MB2132-466	For LQFP-48 (0.5 mm, 7 × 7 mm) FPT-48P-M26	-
PC cable	LAN cable	10BASE-T/100BASE-TX	Selectable
	USB cable	USB1.1	
	RS-232C cable	9pin-9pin cross cable	

[Software]

Software	Part number	Operating System
SOFTUNE V3 Professional Pack	SP3607Z008-P01	WindowsXP/2000

[Flash microcontroller for programming]

Flash microcontroller	Package	Parallel programmer	Serial on board programmer
		Flash Support Group, Inc. AF9708/AF9709/AF9723	Yokogawa Digital Computer Corporation
MB90F387 MB90F387S	LQFP-48 (0.5 mm, 7 × 7 mm) FPT-48P-M26	TEF110-387F15AP-2	AF220/AF210 AF120/AF110

MB90390 series

[Hardware]

Name	Part number	Description	Remarks
Main unit	MB2147-01	High speed version In Circuit Emulator	-
Adapter board	MB2147-20	High speed version For PGA299	-
Evaluation Device	MB90V390HBCR-ES	PGA-299C	-
Probe cable	MB2132-469	For LQFP-120 (0.5 mm, 16 × 16 mm) FPT-120P-M21	-
PC cable	LAN cable	10BASE-T/100BASE-TX	Selectable
	USB cable	USB1.1	
	RS-232C cable	9pin-9pin cross cable	

[Software]

Software	Part number	Operating System
SOFTUNE V3 Professional Pack	SP3607Z008-P01	WindowsXP/2000

[Flash microcontroller for programming]

Flash microcontroller	Package	Parallel programmer	Serial on board programmer
		Flash Support Group, Inc. AF9708/AF9709/AF9723	Yokogawa Digital Computer Corporation
MB90F394HA	LQFP-120 (0.5 mm, 16 × 16 mm) FPT-120P-M21	TEF110-394F16AP	AF220/AF210 AF120/AF110

16-bit Proprietary F²MC-16LX Family Support Tools

MB90M405 series

[Hardware]

Name	Part number	Description	Remarks
Main unit	MB2147-01	High speed version In Circuit Emulator	-
Adapter board	MB2147-10	For PGA256	-
Evaluation Device	MB90MV405CR-ES	PGA-256C	-
Probe cable	MB2132-464	For QFP-100 (0.65 mm, 14 × 20 mm) FPT-100P-M06	-
PC cable	LAN cable	10BASE-T/100BASE-TX	Selectable
	USB cable	USB1.1	
	RS-232C cable	9pin-9pin cross cable	
Evaluation board	BBF2004-MB *	Main board Sunhayato	Option
	BBF2001-100QF2-NB *	Daughter board Sunhayato For QFP-100	

*: To purchase the appropriate product for this model, please contact Sunhayato Corp.

[Software]

Software	Part number	Operating System
SOFTUNE V3 Professional Pack	SP3607Z008-P01	WindowsXP/2000

[Flash microcontroller for programming]

Flash microcontroller	Package	Parallel programmer	Serial on board programmer
		Flash Support Group, Inc. AF9708/AF9709/AF9723	Yokogawa Digital Computer Corporation
MB90MF408	QFP-100 (0.65 mm, 14 × 20 mm) FPT-100P-M06	(Not supported)	AF220/AF210 AF120/AF110

16-bit Proprietary F²MC-16LX Family Support Tools

MB90420G series

[Hardware]

Name	Part number	Description	Remarks
Main unit	MB2147-01	High speed version In Circuit Emulator	-
Adapter board	MB2147-10	For PGA256	-
Evaluation Device	MB90V420GCR-ES	PGA-256C	-
Probe cable	MB2132-496	For LQFP-100 (0.5 mm, 14 × 14 mm) FPT-100P-M05	Selectable
	MB2132-464	For QFP-100 (0.65 mm, 14 × 20 mm) FPT-100P-M06	
PC cable	LAN cable	10BASE-T/100BASE-TX	Selectable
	USB cable	USB1.1	
	RS-232C cable	9pin-9pin cross cable	
Evaluation board	BBF2004-MB	Main board Sunhayato	Option
	BBF2001-100QF2-NB	Daughter board Sunhayato For QFP-100	

[Software]

Software	Part number	Operating System
SOFTUNE V3 Professional Pack	SP3607Z008-P01	WindowsXP/2000

[Flash microcontroller for programming]

Flash microcontroller	Package	Parallel programmer				Serial on board programmer
		Flash Support Group, Inc.	MINATO ELECTRONICS INC.		Data I/O Corporation	Yokogawa Digital Computer Corporation
		AF9708/AF9709/ AF9723	MODEL1890A /1930/1931/ 1893	MODEL1940	OPTIMA Dual-Package OCTAL FlashPAK	
MB90F423GAPFV MB90F423GCPFV	LQFP-100 (0.5 mm, 14 × 14 mm) FPT-100P-M05	TEF110-580F03AP-2	MF00-709A	MF05-709B	(Not supported)	AF220/AF210 AF120/AF110
MB90F423GAPF MB90F423GCPF	QFP-100 (0.65 mm, 14 × 20 mm) FPT-100P-M06	TEF110-553F01AP-2	MF00-989B	MF05-989A	S5023	

16-bit Proprietary F²MC-16LX Family Support Tools

MB90425G series

[Hardware]

Name	Part number	Description	Remarks
Main unit	MB2147-01	High speed version In Circuit Emulator	-
Adapter board	MB2147-10	For PGA256	-
Evaluation Device	MB90V420GCR-ES	PGA-256C	-
Probe cable	MB2132-496	For LQFP-100 (0.5 mm, 14 × 14 mm) FPT-100P-M05	Selectable
	MB2132-464	For QFP-100 (0.65 mm, 14 × 20 mm) FPT-100P-M06	
PC cable	LAN cable	10BASE-T/100BASE-TX	Selectable
	USB cable	USB1.1	
	RS-232C cable	9pin-9pin cross cable	
Evaluation board	BBF2004-MB	Main board Sunhayato	Option
	BBF2001-100QF2-NB	Daughter board Sunhayato For QFP-100	

[Software]

Software	Part number	Operating System
SOFTUNE V3 Professional Pack	SP3607Z008-P01	WindowsXP/2000

[Flash microcontroller for programming]

Flash microcontroller	Package	Parallel programmer				Serial on board programmer
		Flash Support Group, Inc.	MINATO ELECTRONICS INC.		Data I/O Corporation	Yokogawa Digital Computer Corporation
		AF9708/AF9709/ AF9723	MODEL1890A /1930/1931/ 1893	MODEL1940	OPTIMA Dual-Package OCTAL FlashPAK	
MB90F428GAPFV MB90F428GCPFV	LQFP-100 (0.5 mm, 14 × 14 mm) FPT-100P-M05	TEF110-580F03AP-2	MF00-709B	MF05-709B	(Not supported)	AF220/AF210 AF120/AF110
MB90F428GAPF MB90F428GCPF	QFP-100 (0.65 mm, 14 × 20 mm) FPT-100P-M06	TEF110-553F01AP-2	MF00-989B	MF05-989A	S5023	

16-bit Proprietary F²MC-16LX Family Support Tools

MB90435 series

[Hardware]

Name	Part number	Description	Remarks
Main unit	MB2147-01	High speed version In Circuit Emulator	-
Adapter board	MB2147-10	For PGA256	-
Evaluation Device	MB90V540GCR-ES	PGA-256C	-
Probe cable	MB2132-496	For LQFP-100 (0.5 mm, 14 × 14 mm) FPT-100P-M05	Selectable
	MB2132-464	For QFP-100 (0.65 mm, 14 × 20 mm) FPT-100P-M06	
PC cable	LAN cable	10BASE-T/100BASE-TX	Selectable
	USB cable	USB1.1	
	RS-232C cable	9pin-9pin cross cable	
Evaluation board	BBF2004-MB	Main board Sunhayato	Option
	BBF2001-100QF2-NB	Daughter board Sunhayato For QFP-100	

[Software]

Software	Part number	Operating System
SOFTUNE V3 Professional Pack	SP3607Z008-P01	WindowsXP/2000

[Flash microcontroller for programming]

Flash microcontroller	Package	Parallel programmer				Serial on board programmer
		Flash Support Group, Inc. AF9708/AF9709/AF9723	MINATO ELECTRONICS INC.		Data I/O Corporation	Yokogawa Digital Computer Corporation
			MODEL1890A /1930/1931/ 1893	MODEL1940	OPTIMA Dual-Package OCTAL FlashPAK	
MB90F438LPFV MB90F438LSPFV MB90F439PFV MB90F439SPFV	LQFP-100 (0.5 mm, 14 × 14 mm) FPT-100P-M05	TEF110-580F03AP-2	MF00-709A	MF05-709B	(Not supported)	AF220/AF210 AF120/AF110
MB90F438LPPF MB90F438LSPF MB90F439PF MB90F439SPF	QFP-100 (0.65 mm, 14 × 20 mm) FPT-100P-M06	TEF110-553F01AP-2	MF00-989B	MF05-989A	S5023	

16-bit Proprietary F²MC-16LX Family Support Tools

MB90440G series

[Hardware]

Name	Part number	Description	Remarks
Main unit	MB2147-01	High speed version In Circuit Emulator	-
Adapter board	MB2147-10	For PGA256	-
Evaluation Device	MB90V440GCR-ES	PGA-256C	-
Probe cable	MB2132-464	For QFP-100 (0.65 mm, 14 × 20 mm) FPT-100P-M06	-
PC cable	LAN cable	10BASE-T/100BASE-TX	Selectable
	USB cable	USB1.1	
	RS-232C cable	9pin-9pin cross cable	

[Software]

Software	Part number	Operating System
SOFTUNE V3 Professional Pack	SP3607Z008-P01	WindowsXP/2000

[Flash microcontroller for programming]

Flash microcontroller	Package	Parallel programmer				Serial on board programmer
		Flash Support Group, Inc.	MINATO ELECTRONICS INC.		Data I/O Corporation	Yokogawa Digital Computer Corporation
		AF9708/AF9709/ AF9723	MODEL1890A/ 1930/1931/ 1893	MODEL1940	OPTIMA Dual-Package OCTAL FlashPAK	
MB90F443GPF	QFP-100 (0.65 mm, 14 × 20 mm) FPT-100P-M06	TEF110-553F01AP-2	MF00-989B	MF05-989A	S5023	AF220/AF210 AF120/AF110

16-bit Proprietary F²MC-16LX Family Support Tools

MB90455 series

[Hardware]

Name	Part number	Description	Remarks
Main unit	MB2147-01	High speed version In Circuit Emulator	-
Adapter board	MB2147-10	For PGA256	-
Evaluation Device	MB90V495GCR-ES	PGA-256C	-
Probe cable	MB2132-466	For LQFP-48 (0.5 mm, 7 × 7 mm) FPT-48P-M26	-
PC cable	LAN cable	10BASE-T/100BASE-TX	Selectable
	USB cable	USB1.1	
	RS-232C cable	9pin-9pin cross cable	

[Software]

Software	Part number	Operating System
SOFTUNE V3 Professional Pack	SP3607Z008-P01	WindowsXP/2000

[Flash microcontroller for programming]

Flash microcontroller	Package	Parallel programmer	Serial on board programmer
		Flash Support Group, Inc. AF9708/AF9709/AF9723	Yokogawa Digital Computer Corporation
MB90F455 MB90F455S MB90F456 MB90F456S MB90F457 MB90F457S	LQFP-48 (0.5 mm, 7 × 7 mm) FPT-48P-M26	TEF110-387F15AP-2	AF220/AF210 AF120/AF110

16-bit Proprietary F²MC-16LX Family Support Tools

MB90460 series

[Hardware]

Name	Part number	Description	Remarks
Main unit	MB2147-01	High speed version In Circuit Emulator	-
Adapter board	MB2147-10	For PGA256	-
Evaluation Device	MB90V460CR-ES	PGA-256C	-
Probe cable	MB2132-434	For SH-DIP-64 DIP-64P-M01	Selectable
	MB2132-434 + 64SD-64QF-8L	For QFP-64 (1.0 mm, 14 × 20 mm) FPT-64P-M06	
	MB2132-461	For LQFP-64 (0.65 mm, 12 × 12 mm) FPT-64P-M09	
PC cable	LAN cable	10BASE-T/100BASE-TX	Selectable
	USB cable	USB1.1	
	RS-232C cable	9pin-9pin cross cable	

[Software]

Software	Part number	Operating System
SOFTUNE V3 Professional Pack	SP3607Z008-P01	WindowsXP/2000

[Flash microcontroller for programming]

Flash microcontroller	Package	Parallel programmer				Serial on board programmer
		Flash Support Group, Inc.	MINATO ELECTRONICS INC.		Data I/O Corporation	Yokogawa Digital Computer Corporation
		AF9708/AF9709/ AF9723	MODEL1890A/ 1930/1931/ 1893	MODEL1940	OPTIMA Dual-Package OCTAL FlashPAK	
MB90F462P	SH-DIP-64 DIP-64P-M01	TEF110-562F05AP-2	MF13-787B	(Under planning)	(Not supported)	AF220/AF210 AF120/AF110
MB90F462PF	QFP-64 (1.0 mm, 14 × 20 mm) FPT-64P-M06	TEF110-562F06AP-2	MF13-785B	(Under planning)	(Not supported)	
MB90F462PFM	LQFP-64 (0.65 mm, 12 × 12 mm) FPT-64P-M09	TEF110-562F07AP-2	MF13-786B	(Under planning)	(Not supported)	

16-bit Proprietary F²MC-16LX Family Support Tools

MB90480B/485B series

[Hardware]

Name	Part number	Description	Remarks
Main unit	MB2147-01	High speed version In Circuit Emulator	-
Adapter board	MB2147-20	High speed version For PGA299	-
Evaluation Device	MB90V480BCR-ES	PGA-299C, for MB90480B series	Selectable
	MB90V485BCR-ES	PGA-299C, for MB90485B series	
Probe cable	MB2132-496	For LQFP-100 (0.5 mm, 14 × 14 mm) FPT-100P-M05	Selectable
	MB2132-464	For QFP-100 (0.65 mm, 14 × 20 mm) FPT-100P-M06	
PC cable	LAN cable	10BASE-T/100BASE-TX	Selectable
	USB cable	USB1.1	
	RS-232C cable	9pin-9pin cross cable	
Evaluation board	BBF2004-MB *	Main board Sunhayato	Option
	BBF2001-100QF2-NB *	Daughter board Sunhayato For QFP-100	

*: To purchase the appropriate product for this model, please contact Sunhayato Corp.

[Software]

Software	Part number	Operating System
SOFTUNE V3 Professional Pack	SP3607Z008-P01	WindowsXP/2000

[Flash microcontroller for programming]

Flash microcontroller	Package	Parallel programmer				Serial on board programmer
		Flash Support Group, Inc.	MINATO ELECTRONICS INC.		Data I/O Corporation	Yokogawa Digital Computer Corporation
		AF9708/AF9709/ AF9723	MODEL1890A /1930/1931/ 1893	MODEL1940	OPTIMA Dual-Package OCTAL FlashPAK	
MB90F481BPFV MB90F482BPFV MB90F488BPFV MB90F489BPFV	LQFP-100 (0.5 mm, 14 × 14 mm) FPT-100P-M05	TEF110-580F03AP-2	MF00-709A	MF05-709B	(Not supported)	AF220/AF210 AF120/AF110
MB90F481BPF MB90F482BPF MB90F488BPF MB90F489BPF	QFP-100 (0.65 mm, 14 × 20 mm) FPT-100P-M06	TEF110-553F01AP-2	MF00-989B	MF05-989A	S5023	

16-bit Proprietary F²MC-16LX Family Support Tools

MB90495G series

[Hardware]

Name	Part number	Description	Remarks
Main unit	MB2147-01	High speed version In Circuit Emulator	-
Adapter board	MB2147-10	For PGA256	-
Evaluation Device	MB90V495GCR-ES	PGA-256C	-
Probe cable	MB2132-461	For LQFP-64 (0.65 mm, 12 × 12 mm) FPT-64P-M09	Selectable
	MB2132-434 + 64SD-64QF-8L	For QFP-64 (1.0 mm, 14 × 20 mm) FPT-64P-M06	
PC cable	LAN cable	10BASE-T/100BASE-TX	Selectable
	USB cable	USB1.1	
	RS-232C cable	9pin-9pin cross cable	

[Software]

Software	Part number	Operating System
SOFTUNE V3 Professional Pack	SP3607Z008-P01	WindowsXP/2000

[Flash microcontroller for programming]

Flash microcontroller	Package	Parallel programmer				Serial on board programmer
		Flash Support Group, Inc.	MINATO ELECTRONICS INC.		Data I/O Corporation	Yokogawa Digital Computer Corporation
		AF9708/AF9709/ AF9723	MODEL1890A/ 1930/1931/ 1893	MODEL1940	OPTIMA Dual-Package OCTAL FlashPAK	
MB90F497GPF MB90F498GPF	QFP-64 (1.0 mm, 14 × 20 mm) FPT-64P-M06	TEF110-562F06AP-2	MF13-785B	MF05-785B	(Not supported)	AF220/AF210 AF120/AF110
MB90F497GPFM MB90F498GPFM	LQFP-64 (0.65 mm, 12 × 12 mm) FPT-64P-M09	TEF110-562F07AP-2	MF13-786B	MF05-786B	(Not supported)	

16-bit Proprietary F²MC-16LX Family Support Tools

MB90520B series

[Hardware]

Name	Part number	Description	Remarks
Main unit	MB2147-01	High speed version In Circuit Emulator	-
Adapter board	MB2147-10	For PGA256	-
Evaluation Device	MB90V520ACR-ES	PGA-256C	-
Probe cable	MB2132-498	For LQFP-120 (0.4 mm, 14 × 14 mm) FPT-120P-M05	Selectable
	MB2132-468	For QFP-120 (0.5 mm, 20 × 20 mm) FPT-120P-M13	
PC cable	LAN cable	10BASE-T/100BASE-TX	Selectable
	USB cable	USB1.1	
	RS-232C cable	9pin-9pin cross cable	

[Software]

Software	Part number	Operating System
SOFTUNE V3 Professional Pack	SP3607Z008-P01	WindowsXP/2000

[Flash microcontroller for programming]

Flash microcontroller	Package	Parallel programmer				Serial on board programmer
		Flash Support Group, Inc.	MINATO ELECTRONICS INC.		Data I/O Corporation	Yokogawa Digital Computer Corporation
		AF9708/AF9709/ AF9723	MODEL1890A/ 1930/1931/ 1893	MODEL1940	OPTIMA Dual-Package OCTAL FlashPAK	
MB90F523BPFF	LQFP-120 (0.4 mm, 14 × 14 mm) FPT-120P-M05	TEF110-523F08AP-2	MF00-22B	MF05-22B	(Not supported)	AF220/AF210 AF120/AF110
MB90F523BPFV	QFP-120 (0.5 mm, 20 × 20 mm) FPT-120P-M13	TEF110-574F02AP-2	MF00-23B	MF05-23B	S5024	

16-bit Proprietary F²MC-16LX Family Support Tools

MB90540G series

[Hardware]

Name	Part number	Description	Remarks
Main unit	MB2147-01	High speed version In Circuit Emulator	-
Adapter board	MB2147-10	For PGA256	-
Evaluation Device	MB90V540GCR-ES	PGA-256C	-
Probe cable	MB2132-496	For LQFP-100 (0.5 mm, 14 × 14 mm) FPT-100P-M05	Selectable
	MB2132-464	For QFP-100 (0.65 mm, 14 × 20 mm) FPT-100P-M06	
PC cable	LAN cable	10BASE-T/100BASE-TX	Selectable
	USB cable	USB1.1	
	RS-232C cable	9pin-9pin cross cable	
Evaluation board	BBF2004-MB	Main board Sunhayato	Option
	BBF2001-100QF2-NB	Daughter board Sunhayato For QFP-100	

[Software]

Software	Part number	Operating System
SOFTUNE V3 Professional Pack	SP3607Z008-P01	WindowsXP/2000

[Flash microcontroller for programming]

Flash microcontroller	Package	Parallel programmer				Serial on board programmer
		Flash Support Group, Inc.	MINATO ELECTRONICS INC.		Data I/O Corporation	Yokogawa Digital Computer Corporation
		AF9708/AF9709/ AF9723	MODEL1890A /1930/1931/ 1893	MODEL1940	OPTIMA Dual-Package OCTAL FlashPAK	
MB90F543GPFV MB90F543GSPFV	LQFP-100 (0.5 mm, 14 × 14 mm) FPT-100P-M05	TEF110-580F03AP-2	MF00-709A	MF05-709B	(Not supported)	AF220/AF210 AF120/AF110
MB90F543GPF MB90F543GSPF	QFP-100 (0.65 mm, 14 × 20 mm) FPT-100P-M06	TEF110-553F01AP-2	MF00-989B	MF05-989A	S5023	

16-bit Proprietary F²MC-16LX Family Support Tools

MB90545G series

[Hardware]

Name	Part number	Description	Remarks
Main unit	MB2147-01	High speed version In Circuit Emulator	-
Adapter board	MB2147-10	For PGA256	-
Evaluation Device	MB90V540GCR-ES	PGA-256C	-
Probe cable	MB2132-496	For LQFP-100 (0.5 mm, 14 × 14 mm) FPT-100P-M05	Selectable
	MB2132-464	For QFP-100 (0.65 mm, 14 × 20 mm) FPT-100P-M06	
PC cable	LAN cable	10BASE-T/100BASE-TX	Selectable
	USB cable	USB1.1	
	RS-232C cable	9pin-9pin cross cable	
Evaluation board	BBF2004-MB	Main board Sunhayato	Option
	BBF2001-100QF2-NB	Daughter board Sunhayato For QFP-100	

[Software]

Software	Part number	Operating System
SOFTUNE V3 Professional Pack	SP3607Z008-P01	WindowsXP/2000

[Flash microcontroller for programming]

Flash microcontroller	Package	Parallel programmer				Serial on board programmer
		Flash Support Group, Inc.	MINATO ELECTRONICS INC.		Data I/O Corporation	Yokogawa Digital Computer Corporation
			AF9708/AF9709/ AF9723	MODEL1890A /1930/1931/ 1893	MODEL1940	
MB90F546GPFV MB90F546GSPFV MB90F548GPFV MB90F548GSPFV MB90F548GLPFV MB90F548GLSPFV MB90F549GPFV MB90F549GSPFV	LQFP-100 (0.5 mm, 14 × 14 mm) FPT-100P-M05	TEF110-580F03AP-2	MF00-709A	MF05-709B	(Not supported)	AF220/AF210 AF120/AF110
MB90F546GPF MB90F546GSPF MB90F548GPF MB90F548GSPF MB90F548GLPF MB90F548GLSPF MB90F549GPF MB90F549GSPF	QFP-100 (0.65 mm, 14 × 20 mm) FPT-100P-M06	TEF110-553F01AP-2	MF00-989B	MF05-989A	S5023	

16-bit Proprietary F²MC-16LX Family Support Tools

MB90550A/550B series

[Hardware]

Name	Part number	Description	Remarks
Main unit	MB2147-01	High speed version In Circuit Emulator	-
Adapter board	MB2147-10	For PGA256	-
Evaluation Device	MB90V550ACR-ES	PGA-256C	-
Probe cable	MB2132-496	For LQFP-100 (0.5 mm, 14 × 14 mm) FPT-100P-M05	Selectable
	MB2132-464	For QFP-100 (0.65 mm, 14 × 20 mm) FPT-100P-M06	
PC cable	LAN cable	10BASE-T/100BASE-TX	Selectable
	USB cable	USB1.1	
	RS-232C cable	9pin-9pin cross cable	
Evaluation board	BBF2004-MB	Main board Sunhayato	Option
	BBF2001-100QF2-NB	Daughter board Sunhayato For QFP-100	

[Software]

Software	Part number	Operating System
SOFTUNE V3 Professional Pack	SP3607Z008-P01	WindowsXP/2000

[Flash microcontroller for programming]

Flash microcontroller	Package	Parallel programmer				Serial on board programmer
		Flash Support Group, Inc.	MINATO ELECTRONICS INC.		Data I/O Corporation	Yokogawa Digital Computer Corporation
		AF9708/AF9709/ AF9723	MODEL1890A /1930/1931/ 1893	MODEL1940	OPTIMA Dual-Package OCTAL FlashPAK	
MB90F553APFV	LQFP-100 (0.5 mm, 14 × 14 mm) FPT-100P-M05	TEF110-580F03AP-2	MF00-709A	MF05-709B	(Not supported)	AF220/AF210 AF120/AF110
MB90F553APF	QFP-100 (0.65 mm, 14 × 20 mm) FPT-100P-M06	TEF110-553F01AP-2	MF00-989B	MF05-989A	S5023	

16-bit Proprietary F²MC-16LX Family Support Tools

MB90560 series

[Hardware]

Name	Part number	Description	Remarks
Main unit	MB2147-01	High speed version In Circuit Emulator	-
Adapter board	MB2147-10	For PGA256	-
Evaluation Device	MB90V560CR-ES	PGA-256C	-
Probe cable	MB2132-434	For SH-DIP-64 DIP-64P-M01	Selectable
	MB2132-434 + 64SD-64QF-8L	For QFP-64 (1.0 mm, 14 × 20 mm) FPT-64P-M06	
	MB2132-461	For LQFP-64 (0.65 mm, 12 × 12 mm) FPT-64P-M09	
PC cable	LAN cable	10BASE-T/100BASE-TX	Selectable
	USB cable	USB1.1	
	RS-232C cable	9pin-9pin cross cable	

[Software]

Software	Part number	Operating System
SOFTUNE V3 Professional Pack	SP3607Z008-P01	WindowsXP/2000

[Flash microcontroller for programming]

Flash microcontroller	Package	Parallel programmer				Serial on board programmer
		Flash Support Group, Inc.	MINATO ELECTRONICS INC.		Data I/O Corporation	Yokogawa Digital Computer Corporation
		AF9708/AF9709/ AF9723	MODEL1890A /1930/1931/ 1893	MODEL1940	OPTIMA Dual-Package OCTAL FlashPAK	
MB90F562BP	SH-DIP-64 DIP-64P-M01	TEF110-562F05AP-2	MF13-787B	MF05-787B	(Not supported)	AF220/AF210 AF120/AF110
MB90F562BPF	QFP-64 (1.0 mm, 14 × 20 mm) FPT-64P-M06	TEF110-562F06AP-2	MF13-785B	(Under planning)	(Not supported)	
MB90F562BPFM	LQFP-64 (0.65 mm, 12 × 12 mm) FPT-64P-M09	TEF110-562F07AP-2	MF13-786B	MF05-786B	(Not supported)	

16-bit Proprietary F²MC-16LX Family Support Tools

MB90565 series

[Hardware]

Name	Part number	Description	Remarks
Main unit	MB2147-01	High speed version In Circuit Emulator	-
Adapter board	MB2147-10	For PGA256	-
Evaluation Device	MB90V560CR-ES	PGA-256C	-
Probe cable	MB2132-461	For LQFP-64 (0.65 mm, 12 × 12 mm) FPT-64P-M09	Selectable
	MB2132-434 + 64SD-64QF-8L	For QFP-64 (1.0 mm, 14 × 20 mm) FPT-64P-M06	
PC cable	LAN cable	10BASE-T/100BASE-TX	Selectable
	USB cable	USB1.1	
	RS-232C cable	9pin-9pin cross cable	

[Software]

Software	Part number	Operating System
SOFTUNE V3 Professional Pack	SP3607Z008-P01	WindowsXP/2000

[Flash microcontroller for programming]

Flash microcontroller	Package	Parallel programmer				Serial on board programmer
		Flash Support Group, Inc.	MINATO ELECTRONICS INC.		Data I/O Corporation	Yokogawa Digital Computer Corporation
		AF9708/AF9709/AF9723	MODEL1890A /1930/1931/1893	MODEL1940	OPTIMA Dual-Package OCTAL FlashPAK	
MB90F568PF	QFP-64 (1.0 mm, 14 × 20 mm) FPT-64P-M06	TEF110-562F06AP-2	MF13-785B	MF05-785B	(Not supported)	AF220/AF210 AF120/AF110
MB90F568PFM	QFP-64 (0.65 mm, 12 × 12 mm) FPT-64P-M09	TEF110-562F07AP-2	MF13-786B	MF05-786B	(Not supported)	

16-bit Proprietary F²MC-16LX Family Support Tools

MB90570A/570C series

[Hardware]

Name	Part number	Description	Remarks
Main unit	MB2147-01	High speed version In Circuit Emulator	-
Adapter board	MB2147-10	For PGA256	-
Evaluation Device	MB90V570ACR-ES	PGA-256C	-
Probe cable	MB2132-497	For LQFP-120 (0.5 mm, 16 × 16 mm) FPT-120P-M21	Selectable
	MB2132-498	For LQFP-120 (0.4 mm, 14 × 14 mm) FPT-120P-M05	
	MB2132-468	For QFP-120 (0.5 mm, 20 × 20 mm) FPT-120P-M13	
PC cable	LAN cable	10BASE-T/100BASE-TX	Selectable
	USB cable	USB1.1	
	RS-232C cable	9pin-9pin cross cable	

[Software]

Software	Part number	Operating System
SOFTUNE V3 Professional Pack	SP3607Z008-P01	WindowsXP/2000

[Flash microcontroller for programming]

Flash microcontroller	Package	Parallel programmer				Serial on board programmer
		Flash Support Group, Inc.	MINATO ELECTRONICS INC.		Data I/O Corporation	Yokogawa Digital Computer Corporation
		AF9708/AF9709/ AF9723	MODEL1890A /1930/1931/ 1893	MODEL1940	OPTIMA Dual-Package OCTAL FlashPAK	
MB90F574APMT	LQFP-120 (0.5 mm, 16 × 16 mm) FPT-120P-M21	TEF110-574F02AP-2	MF00-729B	MF05-729B	S5024	AF220/AF210 AF120/AF110
MB90F574APFF	LQFP-120 (0.4 mm, 14 × 14 mm) FPT-120P-M05	TEF110-523F08AP-2	MF00-22B	(Under planning)	(Not supported)	
MB90F574APFV	QFP-120 (0.5 mm, 20 × 20 mm) FPT-120P-M13	TEF110-574F04AP-2	MF00-23B	MF05-23B	(Not supported)	

16-bit Proprietary F²MC-16LX Family Support Tools

MB90580C/580CA series

[Hardware]

Name	Part number	Description	Remarks
Main unit	MB2147-01	High speed version In Circuit Emulator	-
Adapter board	MB2147-10	For PGA256	-
Evaluation Device	MB90V580BCR-ES	PGA-256C	-
Probe cable	MB2132-496	For LQFP-100 (0.5 mm, 14 × 14 mm) FPT-100P-M05	Selectable
	MB2132-464	For QFP-100 (0.65 mm, 14 × 20 mm) FPT-100P-M06	
PC cable	LAN cable	10BASE-T/100BASE-TX	Selectable
	USB cable	USB1.1	
	RS-232C cable	9pin-9pin cross cable	
Evaluation board	BBF2004-MB	Main board Sunhayato	Option
	BBF2001-100QF2-NB	Daughter board Sunhayato For QFP-100	

[Software]

Software	Part number	Operating System
SOFTUNE V3 Professional Pack	SP3607Z008-P01	WindowsXP/2000

[Flash microcontroller for programming]

Flash microcontroller	Package	Parallel programmer				Serial on board programmer
		Flash Support Group, Inc.	MINATO ELECTRONICS INC.		Data I/O Corporation	
		AF9708/AF9709/ AF9723	MODEL1890A /1930/1931/ 1893	MODEL1940	OPTIMA Dual-Package OCTAL FlashPAK	Yokogawa Digital Computer Corporation
MB90F583CPFV MB90F583CAPFV MB90F584CPFV MB90F584CAPFV	LQFP-100 (0.5 mm, 14 × 14 mm) FPT-100P-M05	TEF110-580F03AP-2	MF00-709A	MF05-709B	(Not supported)	AF220/AF210 AF120/AF110
MB90F583CPF MB90F583CAPF MB90F584CPF MB90F584CAPF	QFP-100 (0.65 mm, 14 × 20 mm) FPT-100P-M06	TEF110-553F01AP-2	MF00-989B	MF05-989A	S5023	

16-bit Proprietary F²MC-16LX Family Support Tools

MB90590G series

[Hardware]

Name	Part number	Description	Remarks
Main unit	MB2147-01	High speed version In Circuit Emulator	-
Adapter board	MB2147-10	For PGA256	-
Evaluation Device	MB90V590GCR-ES	PGA-256C	-
Probe cable	MB2132-464	For QFP-100 (0.65 mm, 14 × 20 mm) FPT-100P-M06	-
PC cable	LAN cable	10BASE-T/100BASE-TX	Selectable
	USB cable	USB1.1	
	RS-232C cable	9pin-9pin cross cable	
Evaluation board	BBF2004-MB	Main board Sunhayato	Option
	BBF2001-100QF2-NB	Daughter board Sunhayato For QFP-100	

[Software]

Software	Part number	Operating System
SOFTUNE V3 Professional Pack	SP3607Z008-P01	WindowsXP/2000

[Flash microcontroller for programming]

Flash microcontroller	Package	Parallel programmer				Serial on board programmer
		Flash Support Group, Inc.	MINATO ELECTRONICS INC.		Data I/O Corporation	
		AF9708/AF9709/ AF9723	MODEL1890A /1930/1931/ 1893	MODEL1940	OPTIMA Dual-Package OCTAL FlashPAK	Yokogawa Digital Computer Corporation
MB90F591GPF MB90F594GPF	QFP-100 (0.65 mm, 14 × 20 mm) FPT-100P-M06	TEF110-553F01AP-2	MF00-989B	MF05-989A	S5023	AF220/AF210 AF120/AF110

16-bit Proprietary F²MC-16LX Family Support Tools

MB90595G series

[Hardware]

Name	Part number	Description	Remarks
Main unit	MB2147-01	High speed version In Circuit Emulator	-
Adapter board	MB2147-10	For PGA256	-
Evaluation Device	MB90V595GCR-ES	PGA-256C	-
Probe cable	MB2132-464	For QFP-100 (0.65 mm, 14 × 20 mm) FPT-100P-M06	-
PC cable	LAN cable	10BASE-T/100BASE-TX	Selectable
	USB cable	USB1.1	
	RS-232C cable	9pin-9pin cross cable	
Evaluation board	BBF2004-MB	Main board Sunhayato	Option
	BBF2001-100QF2-NB	Daughter board Sunhayato For QFP-100	

[Software]

Software	Part number	Operating System
SOFTUNE V3 Professional Pack	SP3607Z008-P01	WindowsXP/2000

[Flash microcontroller for programming]

Flash microcontroller	Package	Parallel programmer				Serial on board programmer
		Flash Support Group, Inc.	MINATO ELECTRONICS INC.		Data I/O Corporation	Yokogawa Digital Computer Corporation
		AF9708/AF9709/ AF9723	MODEL1890A/ 1930/1931/ 1893	MODEL1940	OPTIMA Dual-Package OCTAL FlashPAK	
MB90F598GPF	QFP-100 (0.65 mm, 14 × 20 mm) FPT-100P-M06	TEF110-553F01AP-2	MF00-989B	MF05-989A	S5023	AF220/AF210 AF120/AF110

16-bit Proprietary F²MC-16LX Family Support Tools

MB90800 series

[Hardware]

Name	Part number	Description	Remarks
Main unit	MB2147-01	High speed version In Circuit Emulator	-
Adapter board	MB2147-20	High speed version For PGA299	-
Evaluation Device	MB90V800-101CR-ES	Single clock, PGA-299C	Selectable
	MB90V800-201CR-ES	Dual clock, PGA-299C	
Probe cable	MB2147-582	For QFP-100 (0.65 mm, 14 × 20 mm) FPT-100P-M06	-
PC cable	LAN cable	10BASE-T/100BASE-TX	Selectable
	USB cable	USB1.1	
	RS-232C cable	9pin-9pin cross cable	
Evaluation board	BBF2004-MB	Main board Sunhayato	Option
	BBF2001-100CL2-NB	Daughter board Sunhayato For QFP-100	

[Software]

Software	Part number	Operating System
SOFTUNE V3 Professional Pack	SP3607Z008-P01	WindowsXP/2000

[Flash microcontroller for programming]

Flash microcontroller	Package	Parallel programmer	Serial on board programmer
		Flash Support Group, Inc. AF9708/AF9709/AF9723	Yokogawa Digital Computer Corporation
MB90F804-101PF-G MB90F804-201PF-G	QFP-100 (0.65 mm, 14 × 20 mm) FPT-100P-M06	TEF110-328F12AP-2	AF220/AF210 AF120/AF110

16-bit Proprietary F²MC-16LX Family Support Tools

MB90820 series

[Hardware]

Name	Part number	Description	Remarks
Main unit	MB2147-01	High speed version In Circuit Emulator	-
Adapter board	MB2147-20	High speed version For PGA299	-
Evaluation Device	MB90V820CR-ES	PGA-299C	-
Probe cable	MB2147-560	For QFP-80 (0.8 mm, 14 × 20 mm) FPT-80P-M06	Selectable
	MB2147-561	For LQFP-80 (0.5 mm, 12 × 12 mm) FPT-80P-M05	
	MB2147-562	For LQFP-80 (0.65 mm, 14 × 14 mm) FPT-80P-M11	
PC cable	LAN cable	10BASE-T/100BASE-TX	Selectable
	USB cable	USB1.1	
	RS-232C cable	9pin-9pin cross cable	
Evaluation board	(Not supported)	Main board	Option
	(Not supported)	Daughter board	

[Software]

Software	Part number	Operating System
SOFTUNE V3 Professional Pack	SP3607Z008-P01	WindowsXP/2000

[Flash microcontroller for programming]

Flash microcontroller	Package	Parallel programmer	Serial on board programmer
		Flash Support Group, Inc. AF9708/AF9709/AF9723	Yokogawa Digital Computer Corporation
MB90F822APF MB90F823APF	QFP-80 (0.8 mm, 14 × 20 mm) FPT-80P-M06	TEF110-822F27AP	AF220/AF210 AF120/AF110
MB90F822APFV MB90F823APFV	LQFP-80 (0.5 mm, 12 × 12 mm) FPT-80P-M05	TEF110-822F28AP	
MB90F822APFM MB90F823APFM	LQFP-80 (0.65 mm, 14 × 14 mm) FPT-80P-M11	TEF110-822F32AP	

16-bit Proprietary F²MC-16LX Family Support Tools

MB90860E series

[Hardware]

Name	Part number	Description	Remarks
Main unit	MB2147-01	High speed version In Circuit Emulator	-
Adapter board	MB2147-20	High speed version For PGA299	-
Evaluation Device	MB90V340E-101CR-ES	Single clock PGA-299C	Selectable
	MB90V340E-102CR-ES	Dual clock, PGA-299C	
Probe cable	MB2147-581	For LQFP-100 (0.5 mm, 14 × 14 mm) FPT-100P-M05	Selectable
	MB2147-582	For QFP-100 (0.65 mm, 14 × 20 mm) FPT-100P-M06	
PC cable	LAN cable	10BASE-T/100BASE-TX	Selectable
	USB cable	USB1.1	
	RS-232C cable	9pin-9pin cross cable	
Evaluation board	BBF2004-MB	Main board Sunhayato	Option
	BBF2001-100CL2-NB	Daughter board Sunhayato For QFP-100	

[Software]

Software	Part number	Operating System
SOFTUNE V3 Professional Pack	SP3607Z008-P01	WindowsXP/2000

[Flash microcontroller for programming]

Flash microcontroller	Package	Parallel programmer	Serial on board programmer
		Flash Support Group, Inc. AF9708/AF9709/AF9723	Yokogawa Digital Computer Corporation
MB90F867EPFV MB90F867ESPFV	LQFP-100 (0.5 mm, 14 × 14 mm) FPT-100P-M05	TEF110-328F13AP-2	AF220/AF210 AF120/AF110
MB90F867EPF MB90F867ESPF	QFP-100 (0.65 mm, 14 × 20 mm) FPT-100P-M06	TEF110-328F12AP-2	

16-bit Proprietary F²MC-16LX Family Support Tools

MB90880 series

[Hardware]

Name	Part number	Description	Remarks
Main unit	MB2147-01	High speed version In Circuit Emulator	-
Adapter board	MB2147-20	High speed version For PGA299	-
Evaluation Device	MB90V880A-101CR-ES	Single clock, PGA-299C	Selectable
	MB90V880A-102CR-ES	Dual clock, PGA-299C	
Probe cable	MB2147-581	For LQFP-100 (0.5 mm, 14 × 14 mm) FPT-100P-M05	Selectable
	MB2147-582	For QFP-100 (0.65 mm, 14 × 20 mm) FPT-100P-M06	
PC cable	LAN cable	10BASE-T/100BASE-TX	Selectable
	USB cable	USB1.1	
	RS-232C cable	9pin-9pin cross cable	
Evaluation board	BBF2004-MB	Main board Sunhayato	Option
	BBF2001-100CL2-NB	Daughter board Sunhayato For QFP-100	

[Software]

Software	Part number	Operating System
SOFTUNE V3 Professional Pack	SP3607Z008-P01	WindowsXP/2000

[Flash microcontroller for programming]

Flash microcontroller	Package	Parallel programmer	Serial on board programmer	
		Flash Support Group, Inc. AF9708/AF9709/AF9723	Yokogawa Digital Computer Corporation	Flash Support Group, Inc.
MB90F882(S)PMC MB90F883A(S)PMC MB90F884A(S)PMC	LQFP-100 (0.5mm, 14 × 14mm) FPT-100P-M20	TEF110-328F13AP-2	AF220/AF210 AF120/AF110	-
MB90F882(S)PF MB90F883A(S)PF MB90F884A(S)PF	QFP-100 (0.65mm, 14 × 20mm) FPT-100P-M06	TEF110-328F12AP-2		

16-bit Proprietary F²MC-16LX Family Support Tools

MB90895 series

[Hardware]

Name	Part number	Description	Remarks
Main unit	MB2147-01	High speed version In Circuit Emulator	-
Adapter board	MB2147-10	For PGA256	-
Evaluation Device	MB90V495GCR-ES	PGA-256C	-
Probe cable	MB2132-466	For LQFP-48 (0.5 mm, 7 × 7 mm) FPT-48P-M26	-
PC cable	LAN cable	10BASE-T/100BASE-TX	Selectable
	USB cable	USB1.1	
	RS-232C cable	9pin-9pin cross cable	

[Software]

Software	Part number	Operating System
SOFTUNE V3 Professional Pack	SP3607Z008-P01	WindowsXP/2000

[Flash microcontroller for programming]

Flash microcontroller	Package	Parallel programmer	Serial on board programmer
		Flash Support Group, Inc. AF9708/AF9709/AF9723	Yokogawa Digital Computer Corporation
MB90F897 MB90F897S	LQFP-48 (0.5 mm, 7 × 7 mm) FPT-48P-M26	TEF110-387F15AP	AF220/AF210 AF120/AF110

MB90920 series

[Hardware]

Name	Part number	Description	Remarks
Main unit	MB2147-01	High speed version In Circuit Emulator	-
Adapter board	MB2147-20	High speed version For PGA299	-
Evaluation Device	MB90V920-101CR-ES	Single clock, PGA-299C	Selectable
	MB90V920-102CR-ES	Dual clock, PGA-299C	
Probe cable/Header board	MB2132-469	For LQFP-120 (0.5mm, 16 × 16mm) FPT-120P-M21	-
PC cable	LAN cable	10BASE-T/100BASE-TX	Selectable
	USB cable	USB1.1	
	RS-232C cable	9pin-9pin cross cable	

[Software]

Software	Part number	Operating System
SOFTUNE V3 Professional Pack	SP3607Z008-P01	WindowsXP/2000

[Flash microcontroller for programming]

Flash microcontroller	Package	Parallel programmer	Serial on board programmer
		Flash Support Group, Inc. AF9708/AF9709/AF9723	Yokogawa Digital Computer Corporation
MB90F922 MB90F922S	LQFP-120 (0.5mm, 16 × 16mm) FPT-120P-M21	TEF110-394F16AP	AF220/AF210 AF120/AF110

16-bit Proprietary F²MC-16LX Family Support Tools

MB90945 series

[Hardware]

Name	Part number	Description	Remarks
Main unit	MB2147-01	High speed version In Circuit Emulator	-
Adapter board	MB2147-20	High speed version For PGA299	-
Evaluation Device	MB90V390HBCR-ES	PGA-299C	-
Probe cable/Header board	MB2147-583	For QFP-100 (0.65mm, 14 × 20 mm) FPT-100P-M06	Selectable
	MB2147-584	For LQFP-100 (0.5mm, 14 × 14 mm) FPT-100P-M05	
PC cable	LAN cable	10BASE-T/100BASE-TX	Selectable
	USB cable	USB1.1	
	RS-232C cable	9pin-9pin cross cable	
Evaluation board	BBF2004-MB	Main board Sunhayato	Option
	BBF2001-100CL2-NB	Daughter board Sunhayato For QFP-100	

[Software]

Software	Part number	Operating System
SOFTUNE V3 Professional Pack	SP3607Z008-P01	WindowsXP/2000

[Flash microcontroller for programming]

Flash microcontroller	Package	Parallel programmer	Serial on board programmer
		Flash Support Group, Inc. AF9708/AF9709/AF9723	Yokogawa Digital Computer Corporation
MB90F946A MB90F947A MB90F949A	For QFP-100 (0.65mm, 14 × 20 mm) FPT-100P-M06	TEF110-328F12AP-2	AF220/AF210 AF120/AF110
	For LQFP-100 (0.5mm, 14 × 14 mm) FPT-100P-M05	TEF110-328F13AP-2	

16-bit Proprietary F²MC-16LX Family Support Tools

MB90960 series

[Hardware]

Name	Part number	Description	Remarks
Main unit	MB2147-01	High speed version In Circuit Emulator	-
Adapter board	MB2147-20	High speed version For PGA299	-
Evaluation Device	MB90V340E-101CR-ES	Single clock, PGA-299C	Selectable
	MB90V340E-102CR-ES	Dual clock, PGA-299C	
Probe cable/Header board	MB2147-521	For LQFP-120 (0.5mm, 16 × 16mm) FPT-120P-M21	-
PC cable	LAN cable	10BASE-T/100BASE-TX	Selectable
	USB cable	USB1.1	
	RS-232C cable	9pin-9pin cross cable	
Evaluation board	BBF2004-MB	Main board Sunhayato	Option
	BBF2001-100CL2-NB	Daughter board Sunhayato For QFP-100	

[Software]

Software	Part number	Operating System
SOFTUNE V3 Professional Pack	SP3607Z008-P01	WindowsXP/2000

[Flash microcontroller for programming]

Flash microcontroller	Package	Parallel programmer	Serial on board programmer
		Flash Support Group, Inc. AF9708/AF9709/AF9723	Yokogawa Digital Computer Corporation
MB90F962 MB90F962S	LQFP-48 (0.5mm, 7 × 7mm) FPT-48P-M26	-	-

MB90980 series

[Hardware]

Name	Part number	Description	Remarks
Main unit	MB2147-01	High speed version In Circuit Emulator	-
Adapter board	MB2147-20	High speed version For PGA299	-
Evaluation Device	MB90V485BCR-ES	PGA-299C	-
Probe cable	MB2147-541	For LQFP-64 (0.5 mm, 10 × 10 mm) FPT-64P-M03	-
PC cable	LAN cable	10BASE-T/100BASE-TX	Selectable
	USB cable	USB1.1	
	RS-232C cable	9pin-9pin cross cable	

[Software]

Software	Part number	Operating System
SOFTUNE V3 Professional Pack	SP3607Z008-P01	WindowsXP/2000

[Flash microcontroller for programming]

Flash microcontroller	Package	Parallel programmer
		Flash Support Group, Inc. AF9708/AF9709/AF9723
MB90F983	LQFP-64 (0.5 mm, 10 × 10 mm) FPT-64P-M03	TEF110-90F983

RAM Monitor Board for F²MC-16LX Family (MB2147-80)

The MB2147-80 is a development support tool for evaluation purposes to output RAM data to an external device as digital data. (Development support option.)

When used in combination with the F²MC-16L/LX emulator (MB2147-01) and adapter board (MB2147-10 or MB2147-20), the MB2147-80 can digitally output data from specified addresses.

Digitally output data is measured or recorded with a measuring instrument such as an oscilloscope or plotter.

- Measurement target: 4 addresses (Lower 16 bits are set.)
Of four channels, two are fixed for bank 00 and the other two can be specified with a measurement bank (same one).
- Access attribute selectable: R, W, R/W
- Dimensions : W170 mm × D150 mm × H22 mm
- Weight : 146 g

MB 2147-80



When MB 2147-80 is combined with MB 2147-01 and MB 2147-10

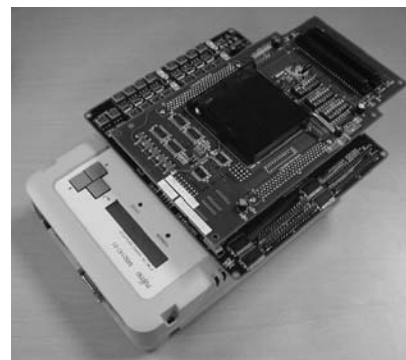

System configuration

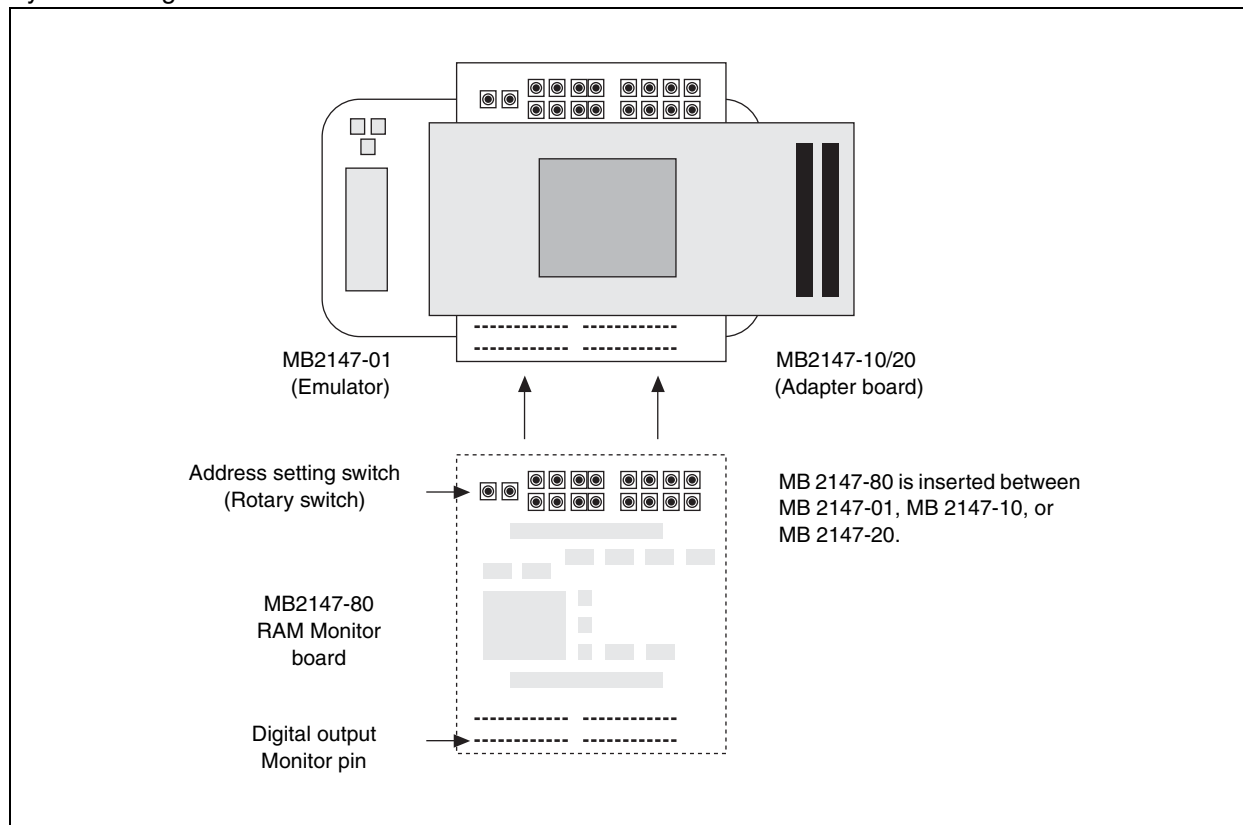

■ MB2000: CAN Flash EVALUATION BOARD

The Flash/CAN100 board was developed, in order to allow a fast software design start for customers wishing to use Fujitsu Flash and / or CAN MCUs in the 100-pin QFP package. Since Fujitsu Microelectronics in-circuit emulators require a target system that provides Vcc and GND, as well as an oscillation circuit, that enables customers to start development or evaluation work straight away without having to wait for their own target hardware.

Features

- 100-pin socket adaptor for device or emulator connection
- On-board regulator allows for a 7-14V unstabilised external DC power supply
- 5V and 3.7V internal power supply available for emulator
- Two high-speed CAN drivers
- RS232 interface
- All MCU pins brought out twice to external connectors
- Optional sub-clock
- RST, HST push-button
- 8 test LEDs
- External reset via RS232

The Flash/CAN100 is supplied with the MB90F598 single-CAN and 128 KByte flash microcontroller. It is capable of supporting all of the following device types:

- MB90540 = MB90V540, MB90F543, MB90543
- MB90545 = MB90V540, MB90F549, MB90F548, MB90548
- MB90550A = MB90V550A, MB90F553A, MB90553A
- MB90580 = MB90V580, MB90F583B, MB90583B
- MB90590 = MB90V590, MB90F594A, MB90594, MB90F591, MB90591
- MB90595 = MB90V595, MB90F598, MB90598

The order code for the kit is FLASH-CAN2-100P-M06 and it is delivered with:

- The Flash/CAN100 board itself
- Two 50-pin socket connectors
- Power supply connector
- MB90F598 - 128kB Flash microcontrollers
- 11 Jumpers
- 1 socket adapter cover
- English documentation

F²MC-16LX Family Adaptors

- Programming adaptors for one-time PROM microcontrollers and EPROM microcontrollers

OTPROM/Flash microcontrollers	Package (lead pitch, body size) (mm)	Package code	Adaptor socket
MB90P553APF	QFP-100 (0.65 mm, □14 × 20 mm)	FPT-100P-M06	ROM-100QF-32DP-16L *1

*: Use a general-purpose EPROM programmer that is able to program a MBM27C1000.

The above adaptor sockets can be purchased from Sunhayato Corp.

Contact for details: Tokyo Japan: Sunhayato Corp. TEL +81-3-3984-7791, FAX +81-3-3971-0535

Notes:

A signal-socket ROM programmer is recommended. Also, contact Fujitsu Microelectronics for programming mounted devices.

Take care to avoid bending the leads when programming QFP packages.

The recommended screening practice before mounting is high temperature aging (+150°C, 48H).

Evaluation Board for USB

It is an evaluation board corresponding to microcontroller for USB. It contributes to the rise of that the simple evaluation of operation before including in a visitor's system is possible, and development efficiency. It is constituted by evaluation board for USB, and a main board and a daughter board. A main board is common to each microcontroller products. By changing a daughter board, debugging by In Circuit Emulator combined with the emulator debugger for microcontroller can be performed.



System configuration

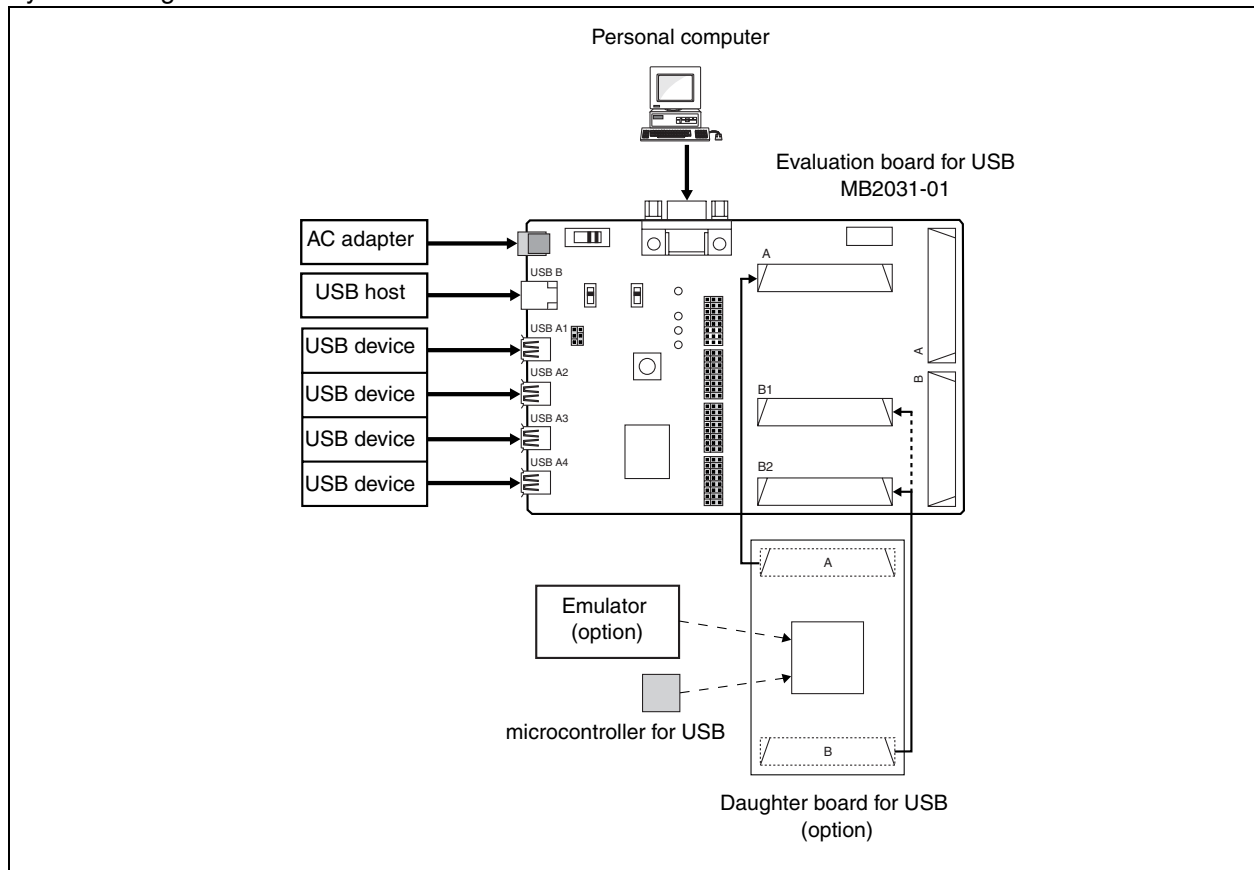

Evaluation board configuration

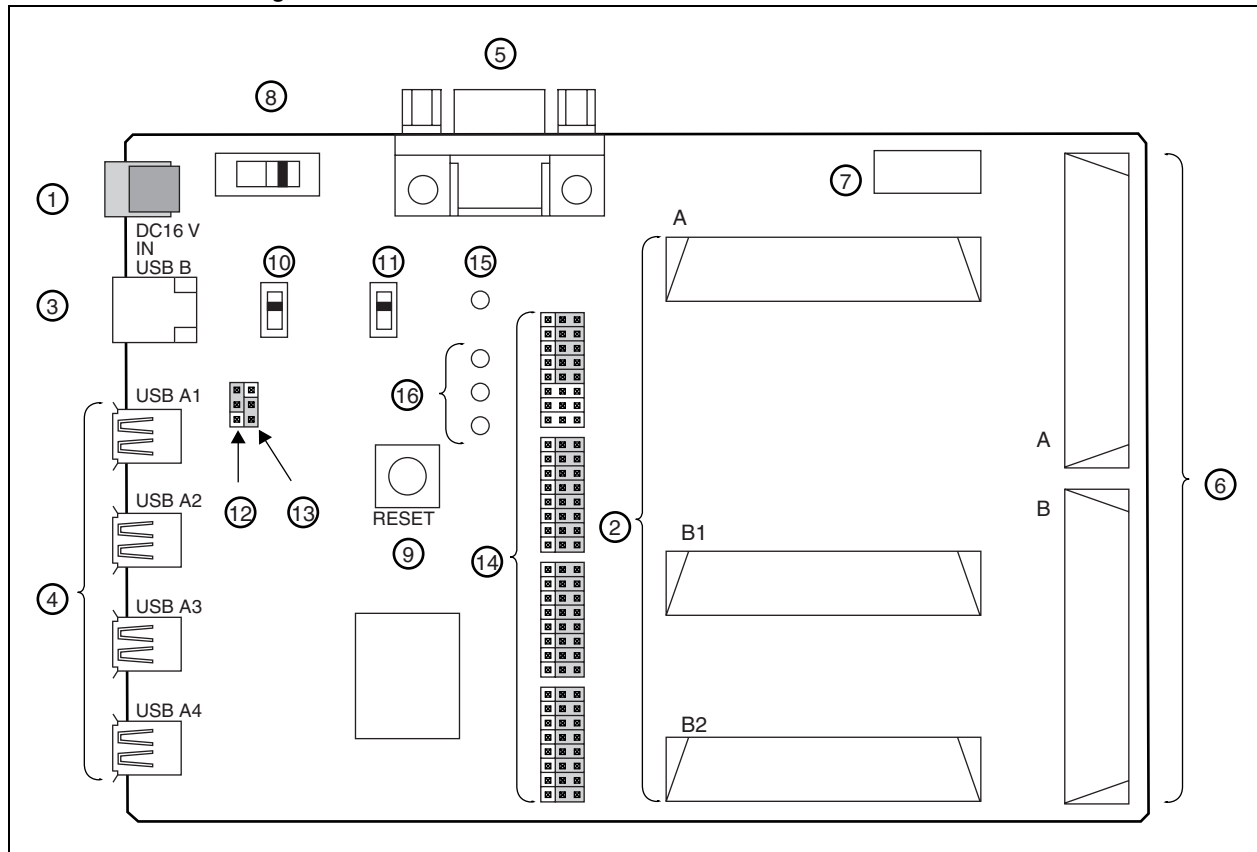

- ① Power connector
- ② Daughter I/F connector

Part number	Target microcontroller	Package
MB2031-10	MB89P585B/BW	LQFP-64 (0.5 mm, □10 mm × 10 mm)
MB2031-11	MB89P589B	LQFP-64 (0.65 mm, □12 mm × 12 mm)
MB2031-20	MB90F334A	LQFP-120 (0.4 mm, □14 mm × 14 mm)

- ③ USB-B connector
- ④ USB-A connector
- ⑤ RS-232C connector
- ⑥ General I/F connector
- ⑦ IC socket for clock mounting
- ⑧ Power switch
- ⑨ Reset switch
- ⑩ USB transmission speed setting switch
- ⑪ USB transmission speed control switch
- ⑫ Short plug for a Power Mode setup (selection of a self-power supply or bus power supply)
- ⑬ Short plug for a MCU Power setup (selection of 3.3 V or 5 V)
- ⑭ Short plug for a functional setup
- ⑮ MCU power LED
- ⑯ USB-LED

■ F²MC-16LX Family Evaluation Board (BBF2004) : Sunhayato

This is an evaluation board made by Sunhayato corp. in correspondence with Fujitsu Microelectronics F²MC-16LX families. It can be used to verify the operating status of F²MC-16LX families before they are actually embedded into a customer's system. As a consequence, development efficiency is accelerated. This board consists of a main board and a daughter board. By changing the daughter board, it can be used for debugging with the (In Circuit Emulator) tool combined with the emulator debugger, evaluating a microcomputer with built-in flash memory and a serial programming. The board is adaptable to various series by changing the daughter board, while the main board is common to each part.

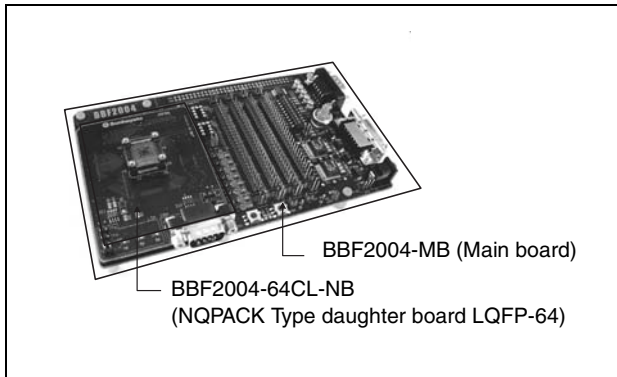

• Evaluation board configuration

Main board (BBF2004-MB)

Daughter board (BBF2004-64CL-NB)

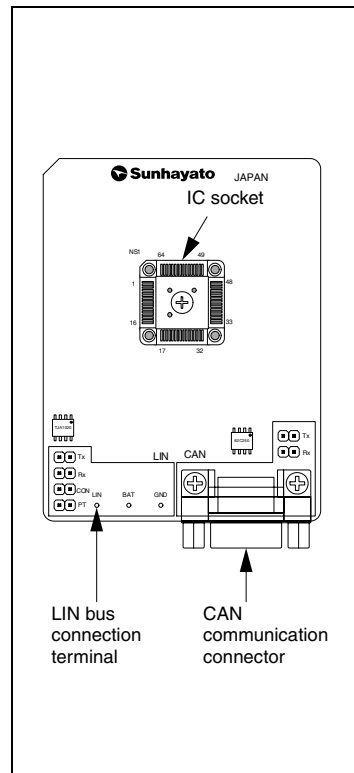
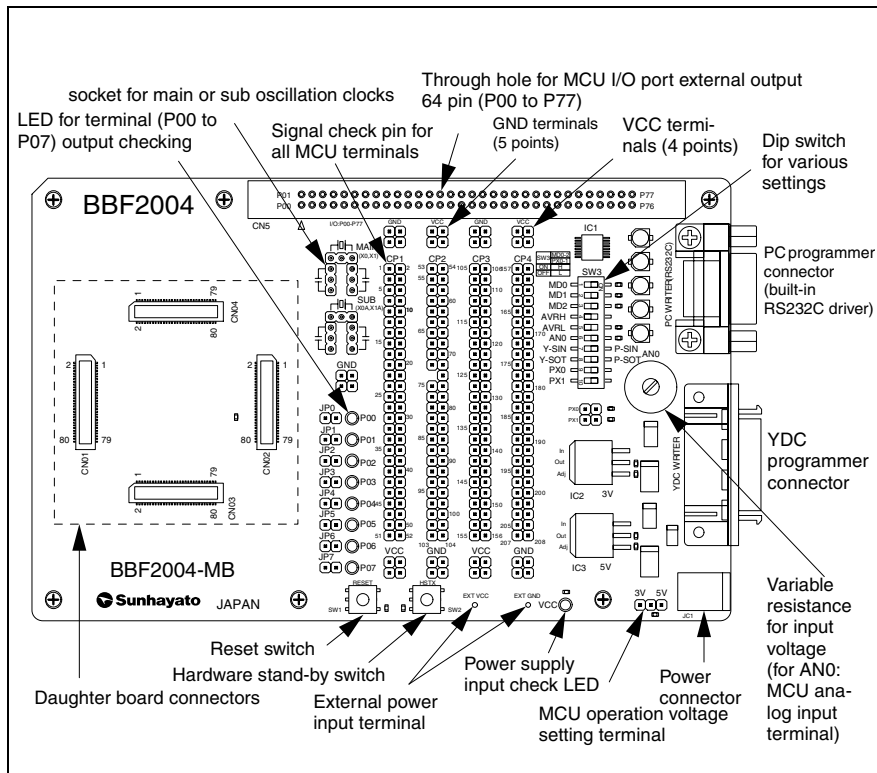

16-bit Proprietary F²MC-16LX Family Support Tools

• Product configuration

Main board

Part number	Description
BBF2004-MB	<ul style="list-style-type: none"> - Locating signal check pin to all terminals - Capability of changing input voltage to analog input terminal AN0 (by variable resistor) - Function of LED lightning for output port (P00 to P17) - Evaluate the capability of communication between PC and microcomputer with UART (mounted DSUB 9pin is possible.) - Can be use the serial programmer made by Fujitsu Microelectronics - Can be use the serial programmer made by Yokogawa Digital Computer corp.

Daughter board

Part number	Description	Target microcontroller	Usage
BBF2004-64CL-NB *	NQPACK type (0.65 mm pitch, □12mm × 12 mm)	MB90350E series	Evaluation board connectable with (In Circuit Emulator) tool. Board for writing and evaluating a microcomputer with a built-in flash memory.

*: Includes CAN transceiver and LIN transceiver

Main board + Daughter board

Part number	Description	Target microcontroller	Usage
BBF2004-64CL-NS *	Main board + NQPACK type (0.65 mm pitch, □12mm × 12 mm)	MB90350E series	Evaluation board connectable with (In Circuit Emulator) tool. Board for writing and evaluating a microcomputer with a built-in flash memory.

*: The daughter board includes CAN transceiver and LIN transceiver.

Target microcontroller

Series name	Package (lead pitch, body size) (mm)
MB90350E series *	LQFP-64(0.65 mm pitch, □12 mm × 12 mm)

Contact for details: Sunhayato Corp.

Serial on Board Programmer

The serial on board programming in Flash memory of the F²MC-16LX family is supported as the following programmer.

FLASH USB Programmer : Fujitsu Microelectronics

This is a FLASH USB Programmer which feature is the small size and low price, and it allows to program by using the microcontroller with Flash memory, personal computer and adaptor (MB2146-09A-E) at the Flash ROM of microcontroller.

(1) System configuration

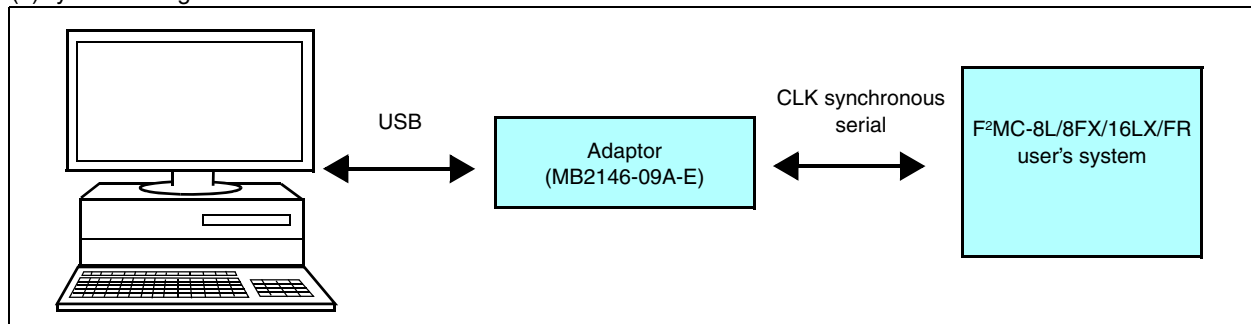

(2) Product configuration

Product name	Part number	Description
Adaptor (programmer)	MB2146-09A-E	F ² MC-8FX ICE and using combinedly (with USB cable)
FLASH USB Programmer	-	Software (download from Web(registration))

(3) Target microcontroller

Version	Target microcontroller
FLASH USB Programmer for 8L/8FX/16LX/FR	MB90F352/C/S/CS, MB90F334, MB90F347 MB90F349, MB90F394, MB90F867 MB90MF408, MB90F423G, MB90F462 MB90F482, MB90F488, MB90F489B MB90F497G, MB90F498G, MB90F543G MB90F548G, MB90F598G, MB90F804 MB90F822, MB90F823, MB90F867 MB90F983 MB90F387, MB90F438L, MB90F548GL MB90F583C, MB90F882, MB90F884 MB90F946A, MB90F947A, MB90F949A

16-bit Proprietary F²MC-16LX Family Support Tools

FLASH MCU Programmer : Fujitsu Microelectronics

This is a FLASH MCU Programmer which feature is the small size and low price, and it allows to program by connection the microcontroller with Flash memory and personal computer at the Flash ROM of microcontroller.

(1) System configuration

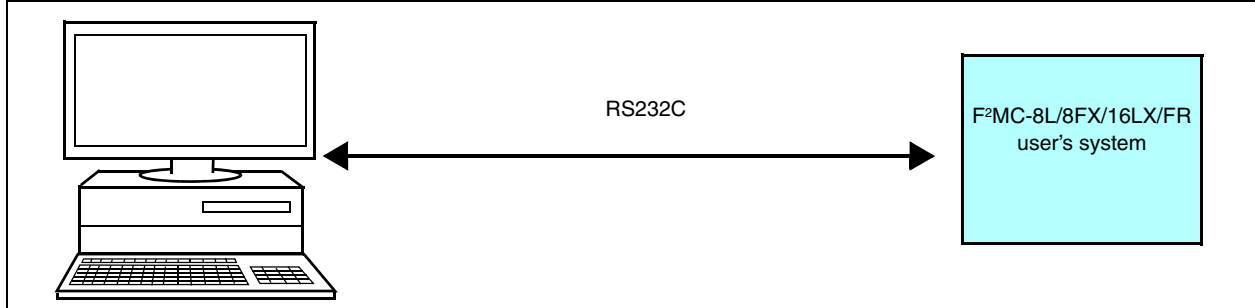

(2) Product configuration

Product name	Part number	Description
FLASH MCU Programmer	-	Software (download from Web(registration))

(3) Target microcontroller

Version	Target microcontroller
LASH MCU Programmer for F ² MC-16LX	MB90F334, MB90F337, MB90F342A/CA/AS/CAS, MB90F342E/CE/ES/CES, MB90F345 A/CA/AS/CAS, MB90F345E/CE/ES/CES, MB90F346A/CA/AS/CAS, MB90F346E/CE/ES/CES, MB90F347A/CA/AS/CAS, MB90F347E/CE/ES/CES, MB90F349 A/CA/AS/CAS, MB90F349E/CE/ES/CES, MB90F351/S, MB90F351A/AS/TA/TAS, MB90F351E/ES/TE/TES, MB90F351B/BS, MB90F352/S, MB90F352A/TAS/TA/AS, MB90F352B/BS, MB90F362E/ES/TE/TES, MB90F372, MB90F378, MB90F387/S, MB90F394/H, MB90F395H, MB90MF408, MB90F423GA/GC, MB90F428GA/GC, MB90F438L/LS, MB90F439/S, MB90F443G, MB90F455/S, MB90F456/S, MB90F457/S, MB90F462, MB90F481, MB90F482, MB90F488, MB90F489, MB90F497/G, MB90F498G, MB90F523B, MB90F543/G/GS, MB90F546G/GS, MB90F548G/GS, MB90F549/G/GS, MB90F553A, MB90F562/B, MB90F568, MB90F574/A, MB90F583B/C/CA, MB90F584C/CA, MB90F591A/G, MB90F594A/G, MB90F598/G, MB90F654A, MB90F804, MB90F822, MB90F823, MB90F867A/AS, MB90F883, MB90F884, MB90F897E/ES, MB90F897/S, MB90F983, MB90F922, MB90F946A, MB90F947A, MB90F949A, MB90F882

16-bit Proprietary F²MC-16LX Family Support Tools

AF220/AF210/AF120/AF110 (Flash microcontroller programmer) Yokogawa Digital Computer Corporation

• System configuration

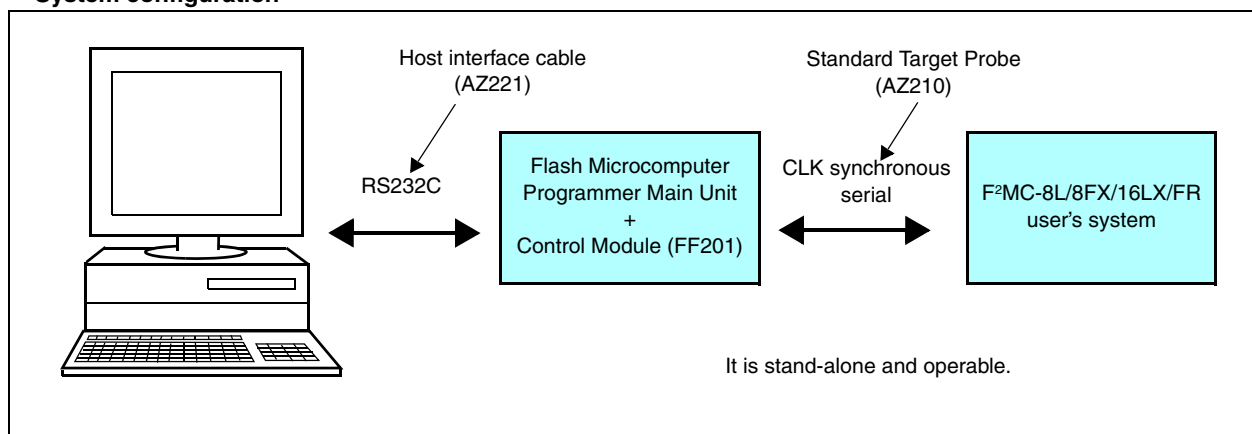

• Product configuration

Product name	Part number	Description
Flash Microcontroller Programmer Main Unit	AF220/AC4P	with Ethernet(10Base-T) Interface /100V to 220V Power supply adaptor
	AF210/AC4P	Basic Model /100V to 220V Power supply adaptor
	AF120/AC4P	Single Operation Model with Ethernet(10Base-T) Interface /100V to 220V Power supply adaptor
	AF110/AC4P	Single Operation Model /100V to 220V Power supply adaptor
Host Interface Cable	AZ221	Writer exclusive use. RS232C cable for PC/AT
Standard Target Probe	AZ210	Standard Target Probe (a): 1 m
Control Modules	FF201	Control modules for F ² MC-16LX OTP or Flash microcontroller made by Fujitsu Microelectronics (High-speed version).
Remote Controller	AZ290	Remote Controller
Memory card	/P2	2MB PC Card
	/P4	4MB PC Card

Contact for details: Yokogawa Digital Computer Corporation

The AF2XX/AF1XX series will terminate the sales in the end of March, 2007 (The maintenance and repair service will be available for the next 5 years after the end of sale). We have the alternative version (AF400/300, AF600/500 series) which includes the enhanced functions of the AF2XX/AF1XX series. For more information, please contact Yokogawa Digital Computer Corporation.
We will continuously provide you the technical support for the subsequent version of Fujitsu microcontrollers.

16-bit Proprietary F²MC-16LX Family Support Tools

AF420/AF620/AF320/AF520 (serial programmer) : Yokogawa Digital Computer

(1) System configuration

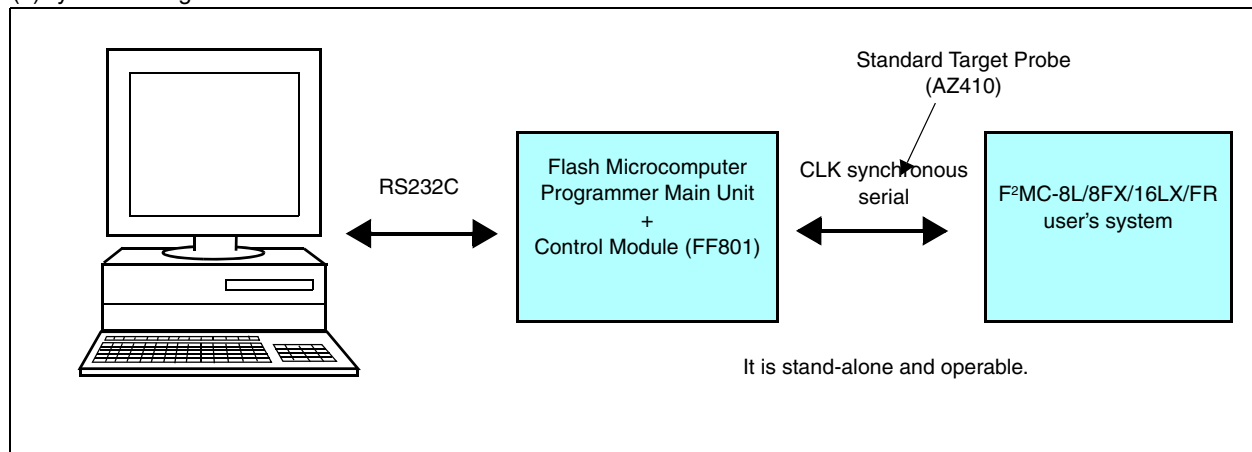

F²MC-16LX Family Support tools

(2) Product configuration

Product name	Part number	Description
Flash Microcontroller Programmer Main Unit	AF420/AC4P	FULL KEY model 100BASE-TX host interface
	AF620/AC4P	FULL KEY model CAN interface 100BASE-TX host interface
	AF320/AC4P	Single KEY model 100BASE-TX host interface
	AF520/AC4P	Single KEY model CAN interface 100BASE-TX host interface
Standard Target Probe	AZ410	Standard Target Probe (a): 1 m
Compact Modules	FF801	Control modules for Fujitsu microcontroller
Remote Controller	AZ490	Remote Controller
Memory card	-	PC Card

Contact for details: Yokogawa Digital Computer Corporation

ITF2000 (Serial Gang programmer): Interface

• System configuration

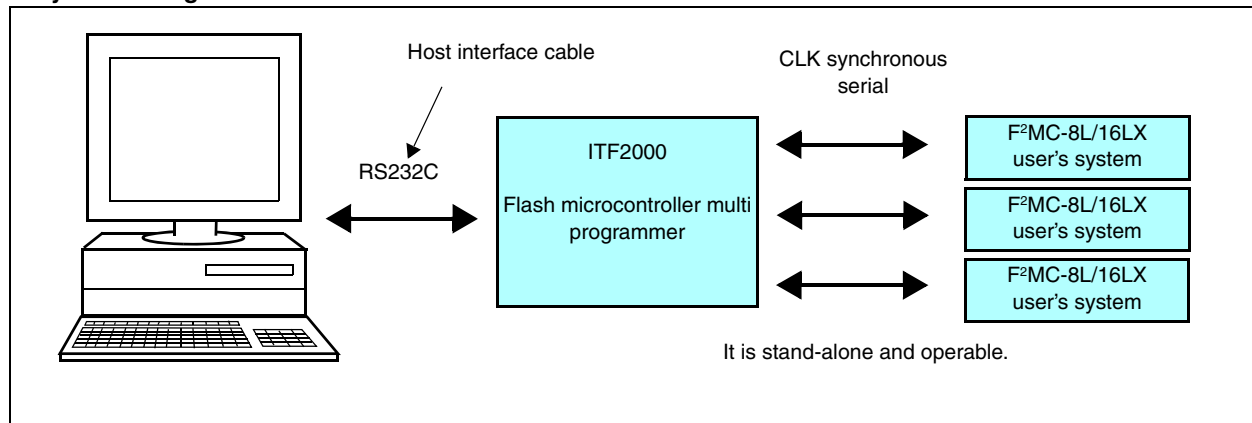

• Product configuration

Product name	Function
ITF2000	Main unit of Flash microcontroller multi programmer (with remote software)
ISP2000	Adaptor for on board programming (with main cable)
CF001 (for F ² MC-16LX family)	Control software
WF001/F001 (for MB90P553A)	Microcontroller module

• Programming adaptor

Part number	Package	Programming adaptor
MB90F553A	QFP-100	TOP2000/QFP100TP1/P1 (single) TOP2000/QFP100TP1/P10 (10 sets)
	LQFP-100	TOP2000/LQFP100TP1/P1 (single) TOP2000/LQFP100TP1/P10 (10 sets)

16-bit Proprietary F²MC-16LX Family Support Tools

AF9101 (Serial programmer): Flash Support Group, Inc.

This is a general-purpose programmer which feature is the small size and low price, and it allows to program on board by using the clock synchronous serial at the Flash ROM of F²MC-16LX family.



F²MC-16LX Family Support tools

• System configuration

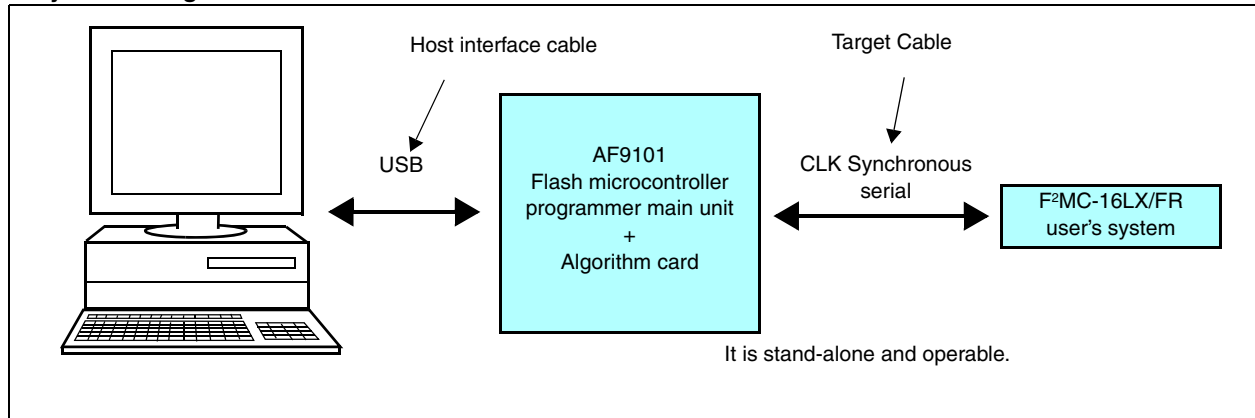

• Product configuration

Product name	Description
AF9101 serial programmer	100V to 220V power supply adaptor
TECFM-256-20	Algorithm card for AF9101
USB cable	—
Target cabl(one of terminals are processed)	—
PC control software	—

• Target microcontroller

Product name	Part number	Target microcontroller
Flash microcontroller programmer main unit	AF9101	MB90F347
		MB90F362

Contact: Flash Support Group, Inc.
 TEL(053)428-8383 FAX(053)428-8377

■ Parallel Programmer for Flash Microcontroller

The parallel programmer in Flash memory of the F²MC-16LX family is supported as the following programmer.

Flash Support Group, Inc.

- **Flash Programmer**

AF9708, AF9709/B: 3 V-products, 5 V-products.



AF9708

AF9709

- **Gang programmer**

Main unit: AF9723

Option unit: AF9833, AF9834, AF9845



The main unit, the option unit, and the program adaptor are combined.

Refer to the device list shown in following URL for the main unit, option unit and the program adaptor corresponding to each microcomputer.

URL <http://www.j-fsg.co.jp/e/top.html>

MINATO ELECTRONICS INC.

- **Universal Programmer**

MODEL 1890A + OU910 (Ver. 4.32b or more)



Notes:

This programmer ended in September, 2000. It is a schedule of correspondence with MODEL1881 (The current state uncorresponds) for the future. Please confirm to MINATO ELECTRONICS INC. when you buy.

MODEL1890A is scheduled to be done in the future to support.

URL http://www.minato.co.jp/index_e.asp

- **Gang Programmer**

MODEL 1893 (Ver. 1.10L or more) , MODEL 1931 (Ver 1.10L or more)

MODEL 1930 + SU3000LX (Ver. 4.10L or more)

MODEL 1895 (Ver. 1.11d or more)



MODEL 1893

- **Gang programmer**

MODEL1940 (Ver. 1.32C or more)



MODEL 1940

16-bit Proprietary F²MC-16LX Family Support Tools

Data I/O Corporation

(Agency) TOYO Corporation

- **Universal Programmer**

OPTIMA, Dual-Package

- **Gang Programmer**

OCTAL, FlashPAK



OPTIMA



Dual-Package



OCTAL

- **Flash MEMORY/Microcomputer Programmer**

FlashPAK



16-bit Proprietary F²MC-16LX Family Support Tools

■ Fujitsu Microcontroller Development Starter Kit

The Fujitsu microcontroller development starter kit allows you to experience a Fujitsu microcontroller development environment using the ACCEMIC MDE monitor debugger.

- Starter kit configuration

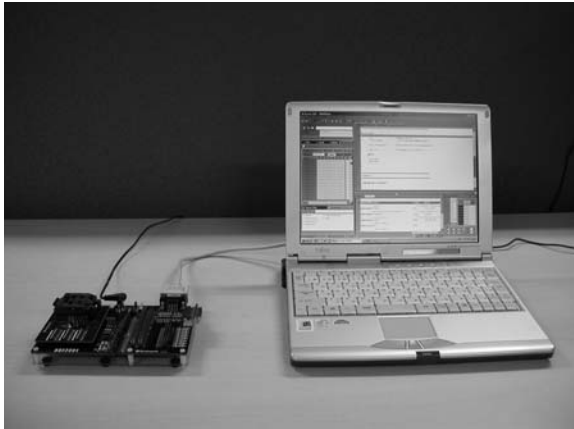

- Monitor debugger software (ACCEMIC MDE screen)

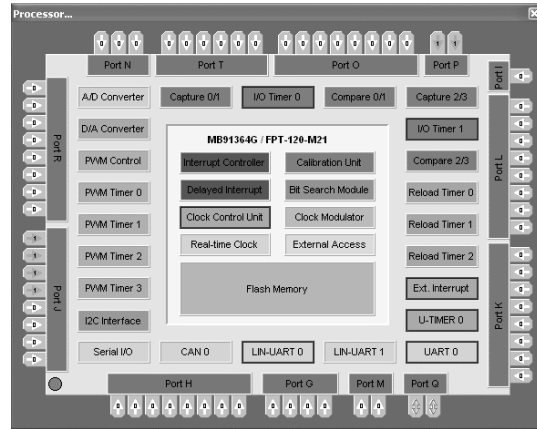

• Fujitsu microcontroller development starter kit enclosure article

Sunhayato evaluation board	It signal-check-pin-arranges for all terminals. Light Emitting Diode lighting control in the port of one part is possible. FLASH memory integrated microcontroller built-in is possible. DSUB 9 pin Connector, RS232C driver IC built-in It corresponds to FLASH memory onboard writing.
ACCEMIC MDE monitor debugger (trial version, program size is to 4KB)	The monitor debugger can construct a development environment only by being connected to the UART communications lines (two lines) in a FLASH memory integrated microcontroller.
Fujitsu Microelectronics SOFTUNE Integrated Development Environment (trial version, 45-day limited)	The development environment for the Fujitsu Microelectronics F ² MC-16LX series of microcontrollers is an integrated suite of programs such as a C compiler, assembler, linker, and debugger.
Others	FLASH memory integrated microcontroller, sample program

• Fujitsu microcontroller development starter kit product lineup

Starter kit product name	Correspondence microcontroller	The feature of a microcontroller
BBF2004-MB90F352-10	MB90F352	CAN:1ch, UART:2ch, A/D:15ch, PKG:64pin, 5V

Contact
Sunhayato Corp. TEL +81-3-3984-7791, FAX +81-3-3971-0535

■ Monitor Debugger ACCEMIC MDE (Accemic GmbH & Co. KG)

Even if development tools are not used, ACCEMIC *1 MDE *2 enables debugging with the flash microcontroller by embedding a debug monitor program and communicating with a host computer during the target program's execution.

*1: ACCEMIC : ACCElerate MICRocontroller designs
*2: MDE : Monitor Debugger Environment

Feature

- Debugging with PC and Flash microcontroller
- Less stress for the microcontroller resources because of the UART function for writing serial data
- Breaking and stepping
- Monitoring memory
- Verify register values on the operating screen
- Setting ports and changing register values without changing programs

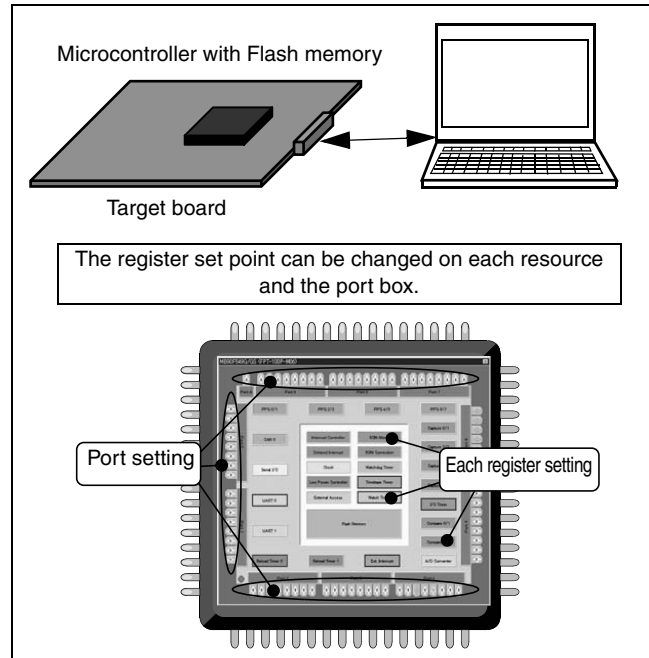

Debugging operation screen

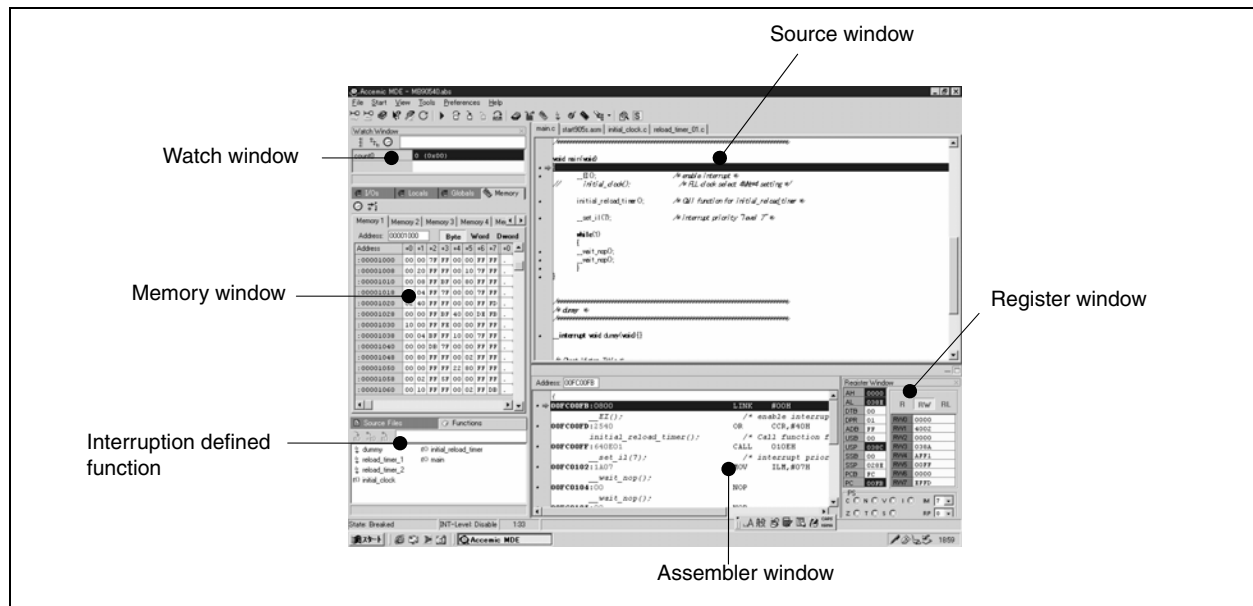

Support MCU

MB90F334A, MB90F337, MB90F342/S/C/CS, MB90F343/S/C/CS, MB90F345/S/C/CS, MB90F347/S/C/CS, MB90F349/S/C/CS, MB90F351B/S/C/CS, MB90F352B/S/C/CS, MB90F362, MB90F367, MB90F387/S, MB90F394H, MB90F395H, MB90F423GA/GB/GC, MB90F428GA/GB/GC, MB90F438L/LS, MB90F439/S, MB90F443G, MB90F455/S, MB90F456/S, MB90F457/S, MB90F462, MB90F481, MB90F482, MB90F488B, MB90F497G, MB90F523B, MB90F543/G/GS, MB90F546G/GS, MB90F548G/GS, MB90F549, MB90F553A, MB90F562/B, MB90F568, MB90F574/A, MB90F583B, MB90F591G, MB90F594G, MB90F598/G, MB90F804, MB90F822, MB90F823, MB90F867/S, MB90F897/S, MB90F946, MB90F947, MB90F962

Contact: FUJITSU ELECTRONICS INC. TEL : 03-3490-6681
Accemic GmbH & Co. KG <http://www.accemic.com/>

Evaluation Tools for Support Hardware F²MC-16FX families (MB2198 emulator)

Features

- DSU support: DSU4
- Linear power supply voltage support from +2.7V to +5.5V
- Supports debugging of source level (assembly and C languages, a mixed indication)
- Simplified graphic interface operation execution using pull-down menu and buttons
- Real time trace function
- Displays source codes, variables, register, memory and trace on multi windows
- Hardware break × 5, software break × 4096, code event × 2, data event × 2
- Operation cycle measurement function
- Host I/F (standard accessories) : RS-232C (max 115 Kbps) , LAN (10BASE-T, 100BASE-TX) , USB 1.1

System Overview

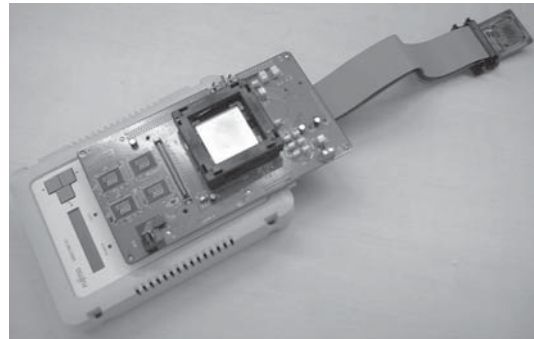

System configuration

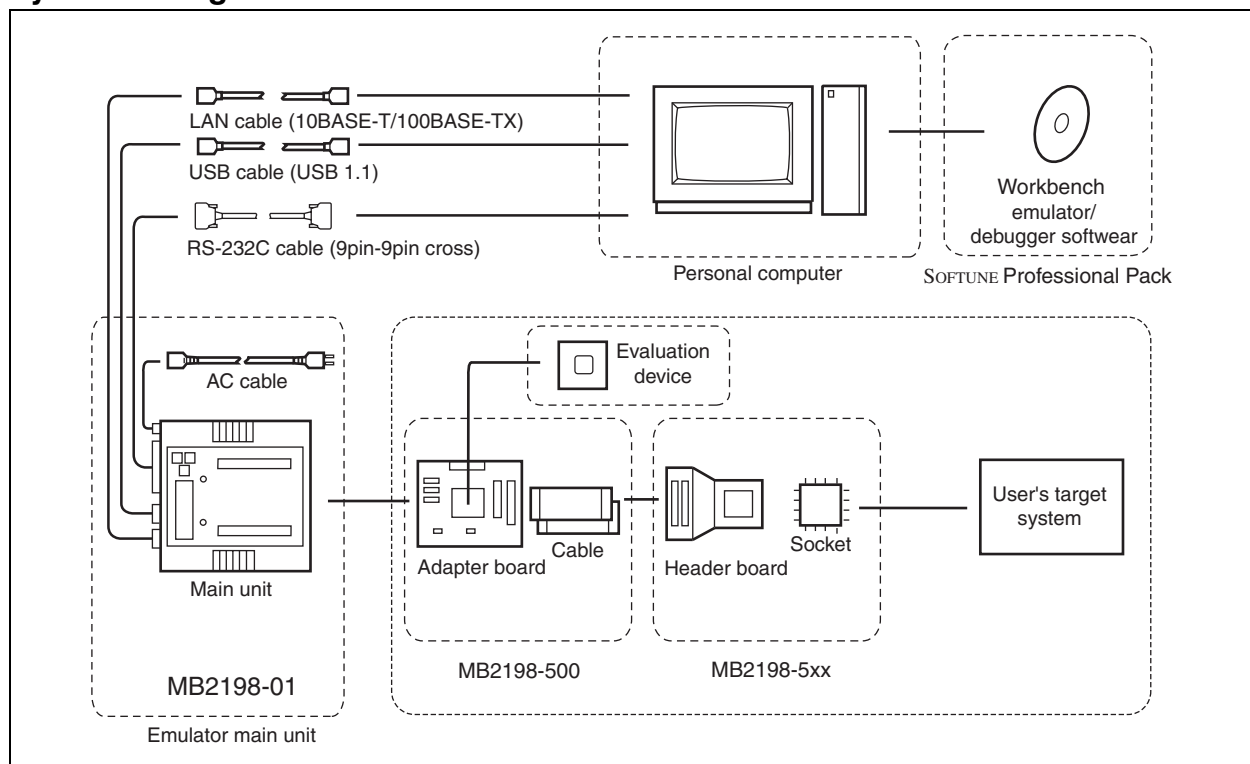

• System configuration for MB96300 series

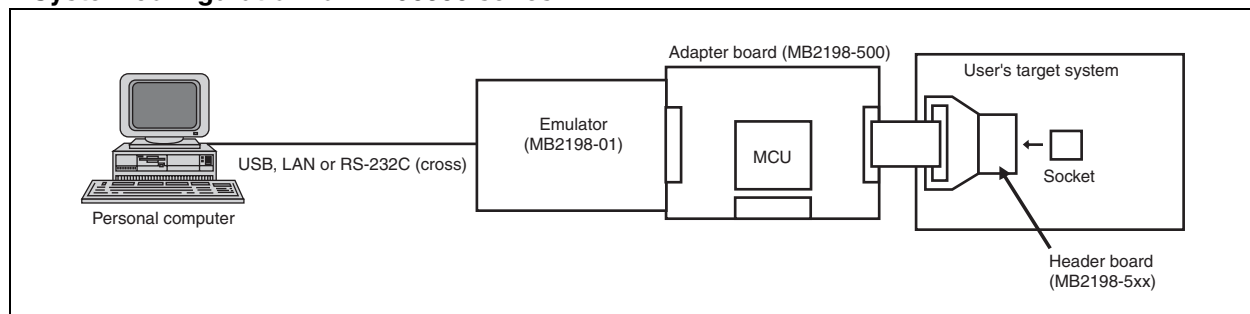

16-bit Proprietary F²MC-16FX Family Support Tools

F²MC-16FX Emulator







• F²MC-16FX emulator main unit

Name	Part number	Remarks	Overview
F ² MC-16FX Emulator main unit	MB2198-01	<ul style="list-style-type: none"> The systems development support tool which used MCU for evaluating F²MC-16FX and builds in DSU interface. Power supply voltage: AC100V or AC200 V Dimensions: 150 mm (width) × 210 mm (depth) × 46 mm (height) Weight: 2.7 kg 	

• Adaptor board

Name	Part number	Remarks	Overview
F ² MC-16FX Adaptor board	MB2198-500	<ul style="list-style-type: none"> For F²MC-16FX (Evaluation device package : BGA-416) Dimensions: 109 mm (width) × 204 mm (depth) × 33 mm (height) Weight: 0.2 kg Includes: Flat cable (standard, long) × each 2 manual 	

• Header board

Name	Part number	Remarks	Overview
QFP-100 0.65mm pitch □ 14 × 20 mm	MB2198-501	<ul style="list-style-type: none"> For MB96340 series Package code: FPT-100P-M22 Includes: NQPACK100RB179-A, HQPACK100RB179 * NQPACK100RB179-A enables probe cable connection and mounted IC evaluation. manual 	
LQFP-100 0.5mm pitch □ 14 × 14 mm	MB2198-502	<ul style="list-style-type: none"> For MB96340 series Package code: FPT-100P-M20 Includes: NQPACK100SD-ND, HQPACK100SD, YQPACK100SD * NQPACK100SD-ND enables probe cable connection and mounted IC evaluation. manual 	
LQFP-64 0.5mm pitch □ 10 × 10 mm	MB2198-503	<ul style="list-style-type: none"> For MB96350 series Package code: FPT-64P-M24 Includes: NQPACK064SD-ND, HQPACK064SD * NQPACK064SD-ND enables probe cable connection and mounted IC evaluation. manual 	
LQFP-64 0.65mm pitch □ 12 × 12 mm	MB2198-504	<ul style="list-style-type: none"> For MB96350 series Package code: FPT-64P-M23 Includes: NQPACK064SB, YQPACK064SB, HQPACK064SB14 * NQPACK064SB enables probe cable connection and mounted IC evaluation. manual 	
LQFP-80 0.5mm pitch □ 12 × 12 mm	MB2198-505	<ul style="list-style-type: none"> For MB96320 series Package code: FPT-80P-M21 Includes: NQPACK080SD-ND, HQPACK080SD * NQPACK080SD-ND enables probe cable connection and mounted IC evaluation. manual 	
LQFP-120 0.65mm pitch □ 16 × 16 mm	MB2198-16FX-120P-M21	<ul style="list-style-type: none"> For MB96380 series Package code: FPT-120P-M21 Includes: NQPACK120SD, HQPACK120SD, YQPACK120SD * NQPACK120SD enables probe cable connection and mounted IC evaluation. manual 	

* :The header board requires NQPACK.

Note: Care is required in printed circuit board pattern design because the position of the board connector part (the flat section at the pin tips) of the NQPACK differs from the mass production product package.

Contact for details: Tokyo Eletech Co, Ltd. TEL(81)3-5295-1661

16-bit Proprietary F²MC-16FX Family Support Tools

Evaluation Tools

MB96320 series

[Hardware]

Name	Part number	Description	Remarks
Main unit	MB2198-01	ICE	-
Adaptor board	MB2198-500	With header cable	-
Header board	MB2198-505	LQFP-80 (0.5 mm, 12 × 12 mm) FPT-80P-M21	-
Evaluation device	MB96V300BRB-ES	BGA416	-
PC cable	LAN cable	10BASE-T/100BASE-TX	Selectable
	USB cable	USB1.1	
	RS-232C cable	9pin-9pin cross cable	

[Software]

Software	Part number	Operating System
SOFTUNE V3 Professional Pack	Under development	WindowsXP/2000

[Flash microcontroller for programming]

Flash microcontroller	Package	Parallel programmer	Serial on board programmer
		Flash Support Group, Inc. AF9708/AF9709/AF9723	Yokogawa Digital Computer Corporation
MB96F326	LQFP-80(0.5 mm, 12 × 12 mm) FPT-80P-M21	(Not supported)	(Not supported)

[Fujitsu Microelectronics PC serial programmer for Flash MCU]

Name	Flash microcontroller	Remarks
FUJITSU FLASH MCU Programmer	Under development	Fujitsu Microelectronics PC serial programmer

MB96340 series

[Hardware]

Name	Part number	Description	Remarks
Main unit	MB2198-01	ICE	-
Adaptor board	MB2198-500	With header cable	-
Header board	MB2198-501	QFP-100 (0.65 mm, 16 × 20 mm) FPT-100P-M22	Selectable
	MB2198-502	LQFP-100 (0.5 mm, 14 × 14 mm) FPT-100P-M20	
Evaluation device	MB96V300BRB-ES	BGA416	-
PC cable	LAN cable	10BASE-T/100BASE-TX	Selectable
	USB cable	USB1.1	
	RS-232C cable	9pin-9pin cross cable	
Evaluation board	BBF2004-MB	Sunhayato Main board	Option
	BBF2001-100CL2-NB	Sunhayato Daughter board for QFP-100	

[Software]

Software	Part number	Operating System
SOFTUNE V3 Professional Pack	Under development	WindowsXP/2000

16-bit Proprietary F²MC-16FX Family Support Tools

[Flash microcontroller for programming]

Flash microcontroller	Package	Parallel programmer	Serial on board programmer
		Flash Support Group, Inc. AF9708/AF9709/AF9723	Yokogawa Digital Computer Corporation
MB96F346/347/348	QFP-100 (0.65 mm, 16 × 20 mm) FPT-100P-M22	TEF110-96F348_QFP	(Not supported)
	LQFP-100 (0.5 mm, 14 × 14 mm) FPT-100P-M20	TEF110-96F348_LQFP	(Not supported)

[Fujitsu Microelectronics PC serial programmer for Flash MCU]

Name	Flash microcontroller	Remarks
FUJITSU FLASH MCU Programmer	MB96F346R/Y MB96F347R/Y MB96F348H/T/R/Y	Fujitsu Microelectronics PC serial programmer

MB96350 series

[Hardware]

Name	Part number	Description	Remarks
Main unit	MB2198-01	ICE	-
Adaptor board	MB2198-500	With header cable	-
Header board	MB2198-503	LQFP-64 (0.5 mm, 10 × 10 mm) FPT-64P-M24	Selectable
	MB2198-504	LQFP-64 (0.65 mm, 12 × 12 mm) FPT-64P-M23	
Evaluation device	MB96V300BRB-ES	BGA416	-
PC cable	LAN cable	10BASE-T/100BASE-TX	Selectable
	USB cable	USB1.1	
	RS-232C cable	9pin-9pin cross cable	
Evaluation board	BBF2004-MB	Sunhayato Main board	Option
	BBF2004-64CL-NB	Sunhayato Daughter board for LQFP-64	

[Software]

Software	Part number	Operating System
SOFTUNE V3 Professional Pack	Under development	WindowsXP/2000

[Flash microcontroller for programming]

Flash microcontroller	Package	Parallel programmer	Serial on board programmer
		Flash Support Group, Inc. AF9708/AF9709/AF9723	Yokogawa Digital Computer Corporation
MB96F346/347/348	LQFP-64 (0.5 mm, 10 × 10 mm) FPT-64P-M24	(Not supported)	(Not supported)
	LQFP-64 (0.65 mm, 12 × 12 mm) FPT-64P-M23	(Not supported)	(Not supported)

[Fujitsu Microelectronics PC serial programmer for Flash MCU]

Name	Flash microcontroller	Remarks
FUJITSU FLASH MCU Programmer	Under development	Fujitsu Microelectronics PC serial programmer

16-bit Proprietary F²MC-16FX Family Support Tools

MB96380 series

[Hardware]

Name	Part number	Description	Remarks
Main unit	MB2198-01	ICE	-
Adaptor board	MB2198-500	With header cable	-
Header board	MB2198-16FX-120P-M21	LQFP-120(0.65 mm, 16 × 16 mm) FPT-120P-M21	-
Evaluation device	MB96V300BRB-ES	BGA416	-
PC cable	LAN cable	10BASE-T/100BASE-TX	Selectable
	USB cable	USB1.1	
	RS-232C cable	9pin-9pin cross cable	

[Software]

Software	Part number	Operating System
SOFTUNE V3 Professional Pack	Under development	WindowsXP/2000

[Flash microcontroller for programming]

Flash microcontroller	Package	Parallel programmer	Serial on board programmer
		Flash Support Group, Inc. AF9708/AF9709/AF9723	Yokogawa Digital Computer Corporation
MB96F326	LQFP-120(0.65 mm, 16 × 16 mm) FPT-120P-M21	TEF110-96F387	(Not supported)

[Fujitsu Microelectronics PC serial programmer for Flash MCU]

Name	Flash microcontroller	Remarks
FUJITSU FLASH MCU Programmer	MB96F386R/Y MB96F387R/Y	Fujitsu Microelectronics PC serial programmer

F²MC-16FX Family Evaluation Board (BBF2004) : Sunhayato

This is an evaluation board made by Sunhayato corp. in correspondence with Fujitsu Microelectronics F²MC-16FX families. It can be used to verify the operating status of F²MC-16FX families before they are actually embedded into a customer's system. As a consequence, development efficiency is accelerated. This board consists of a main board and a daughter board. By changing the daughter board, it can be used for debugging with the (In Circuit Emulator) tool combined with the emulator debugger, evaluating a microcomputer with built-in flash memory and a serial programming. The board is adaptable to various series by changing the daughter board, while the main board is common to each part.

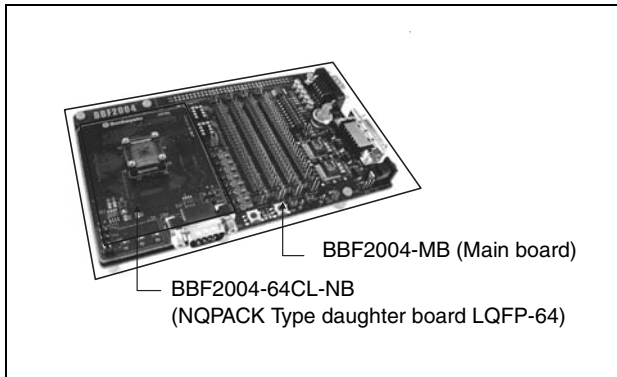

• Evaluation board configuration

Main board (BBF2004-MB)

Daughter board (BBF2004-64CL-NB)

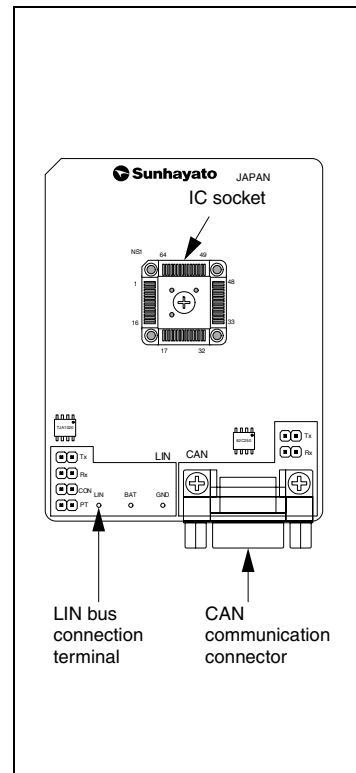
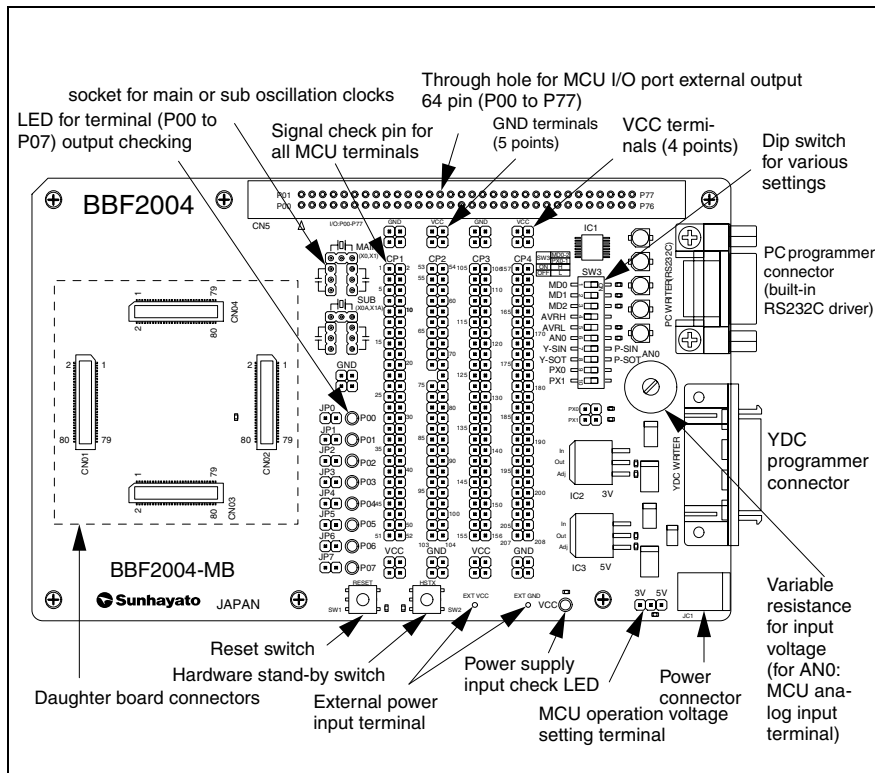

16-bit Proprietary F²MC-16LX Family Support Tools

• Product configuration

Main board

Part number	Description
BBF2004-MB	<ul style="list-style-type: none"> - Locating signal check pin to all terminals - Capability of changing input voltage to analog input terminal AN0 (by variable resistor) - Function of LED lightning for output port (P00 to P17) - Evaluate the capability of communication between PC and microcomputer with UART (mounted DSUB 9pin is possible.) - Can be use the serial programmer made by Fujitsu Microelectronics - Can be use the serial programmer made by Yokogawa Digital Computer corp.

Daughter board

Part number	Description	Target microcontroller	Usage
BBF2004-64CL-NB *	NQPACK type (0.65 mm pitch, □12mm × 12 mm)	MB96350 series	Evaluation board connectable with (In Circuit Emulator) tool. Board for writing and evaluating a microcomputer with a built-in flash memory.
BBF2001-100QF2-NB	NQPACK type (0.65 mm pitch, □14mm × 20 mm)	MB96340 series	
BBF2001-100CL2-NB *	NQPACK type (0.65 mm pitch, □14mm × 20 mm)		

*: Includes CAN transceiver and LIN transceiver

Main board + Daughter board

Part number	Description	Target microcontroller	Usage
BBF2004-64CL-NS *	Main board + NQPACK type (0.65 mm pitch, □12mm × 12 mm)	MB96350 series	Evaluation board connectable with (In Circuit Emulator) tool. Board for writing and evaluating a microcomputer with a built-in flash memory.
BBF2001-100QF2-NS	Main board + NQPACK type (0.65 mm pitch, □14mm × 20 mm)	MB96340 series	
BBF2001-100CL2-NS *	Main board + NQPACK type (0.65 mm pitch, □14mm × 20 mm)		

*: The daughter board includes CAN transceiver and LIN transceiver.

Contact for details: Sunhayato Corp.

Target microcontroller

Series name	Package (lead pitch, body size) (mm)
MB96350 series	LQFP-64(0.65 mm pitch, □12 mm × 12 mm)
MB96340 series	QFP-100(0.65 mm pitch, □14 mm × 20 mm)

■ Sunhayato Microcontroller Starter Kit

Jouet bleu is Microcontroller Starter Kit for the engineer who learns the microcontroller in the future and the embedded system. It is effective as the educational tool of the built-in software development for the student and the new employee.

jouet bleu configuration

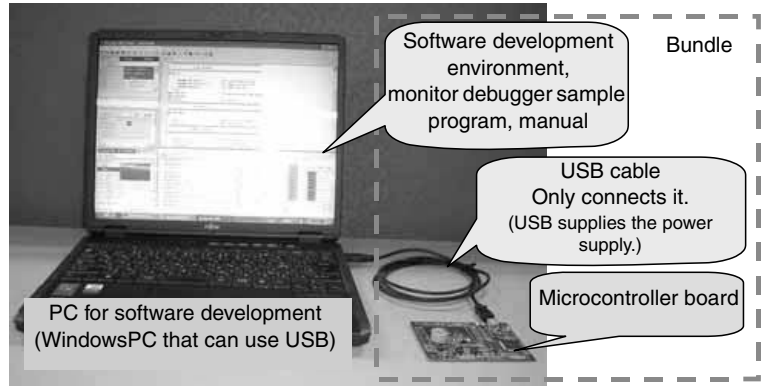

It is possible to learn from the base of the microcontroller to the application by using Fujitsu Microelectronics 16bit microcontroller.

- Mechanism of LED lighting
- LED is controlled by the switch operation.
- Method for sounding a buzzer
- The interruption is planned and how to use.
- How to use of the timer.
- How to use of the temperature sensor.

There are a sample program and a manual for study (The manual prepares Japanese, English, and a Chinese version).



Necessary basic knowledge for building in software the development engineer is obtained only with jouet bleu.

Specification

Microcontroller	MB90F378
USB controller	MB90F334 (Equipped with interface Ltd. firmware)
I/O device	Buzzer, volume of slide, LED × 5, SW × 2, temperature sensor
Operation power supply	Supply by USB bus
I/F with PC	USB (mini B connector)
Size of board	72 × 95 mm
CD-ROM *1	SOFTUNE integration development environment (trial version) *2, ACCEMIC monitor debugger (trial version) *3, Sample program, User's manual
Other accessory	USB cable

Board configuration

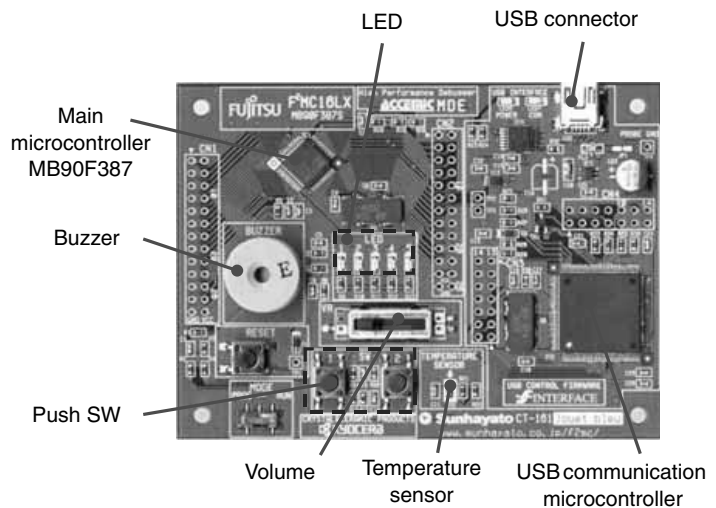

*1: Developing software should download data from Web.
 *2: The program size is limited to 32 KB.
 *3: The debugged program size is limited to 12 KB.

Sales & Contact

Sunhayato Corp.
 TEL: 03-3984-7791
 FAX: 03-3971-0535
 URL: <http://www.sunhayato.co.jp/f2mc/>

32-bit FR Family

FR Family Features

- CPU core capable of running at a peak rate of 64 VAX MIPS (CPU core performance) at 50 MHz while featuring its compactness equivalent to 16-bit microcontrollers
- 5-stage pipelining and harvard-bus architecture, allowing efficient execution
- Implementation of, basically, 16-bit fixed length commands, providing high object code efficiency
- The command group enhanced for controllers and an algorithm engine, resulting in faster execution of instructions
- A variety of resources including the sum-of-product units
- Many kinds of internal peripheral devices
- **FR architecture features**

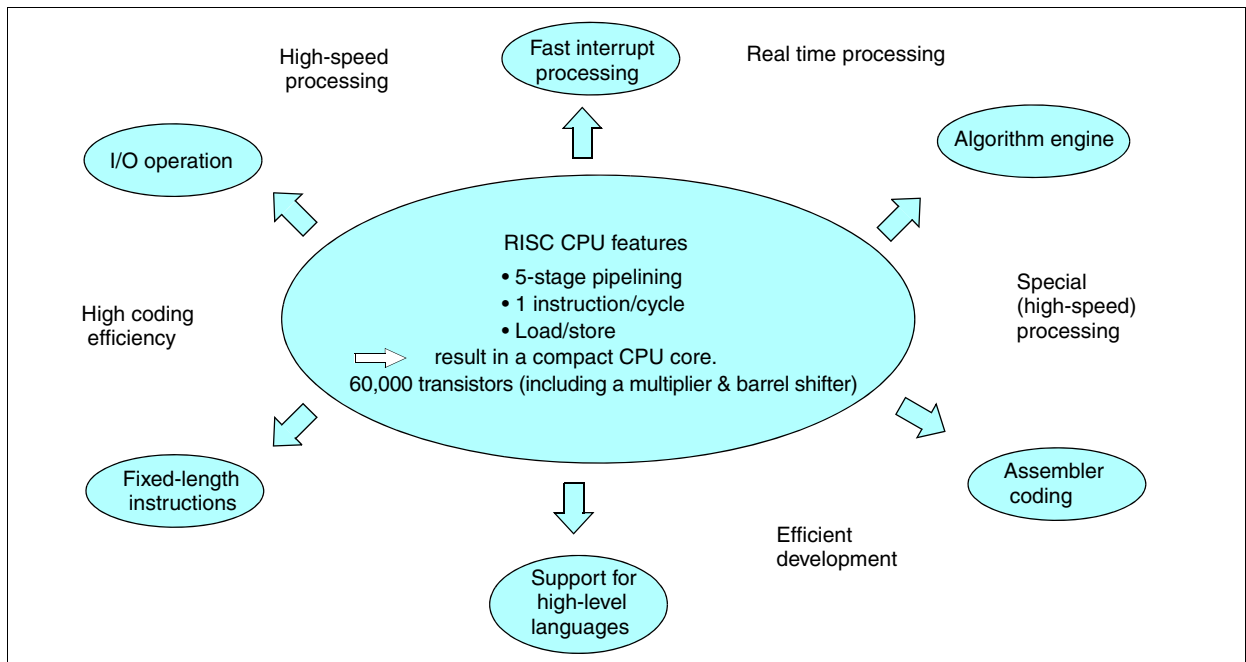

Fujitsu Microelectronics embedded RISC controller

The FR family is designed for optimum use in control systems while the SPARClite is suitable for data processing systems.

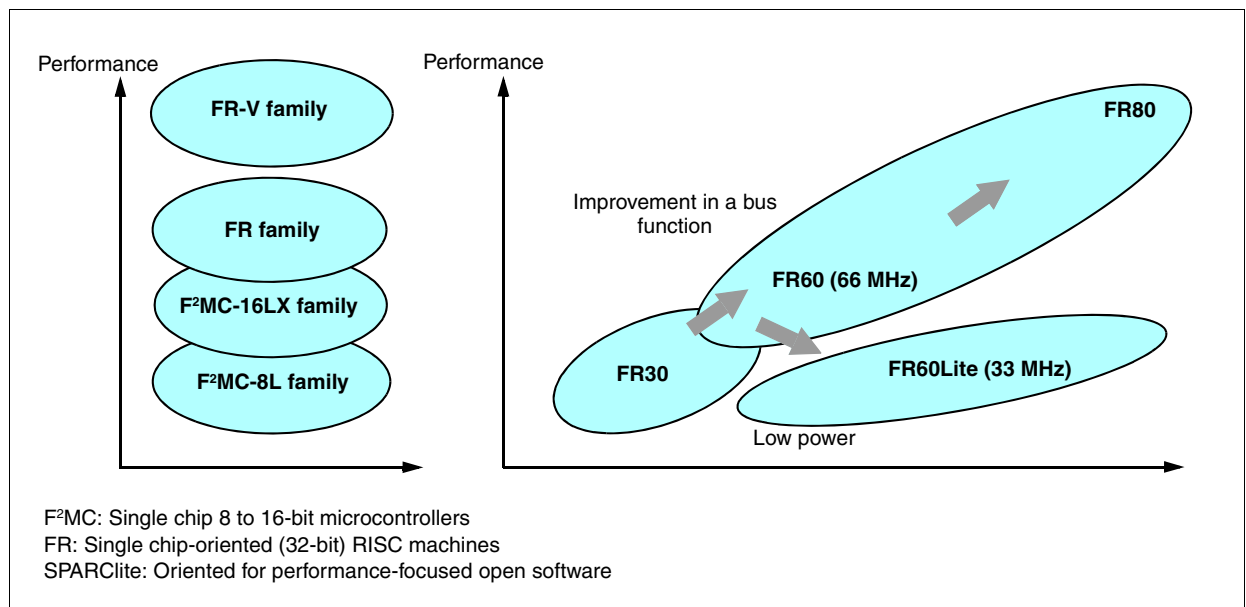

FR Family Product Range

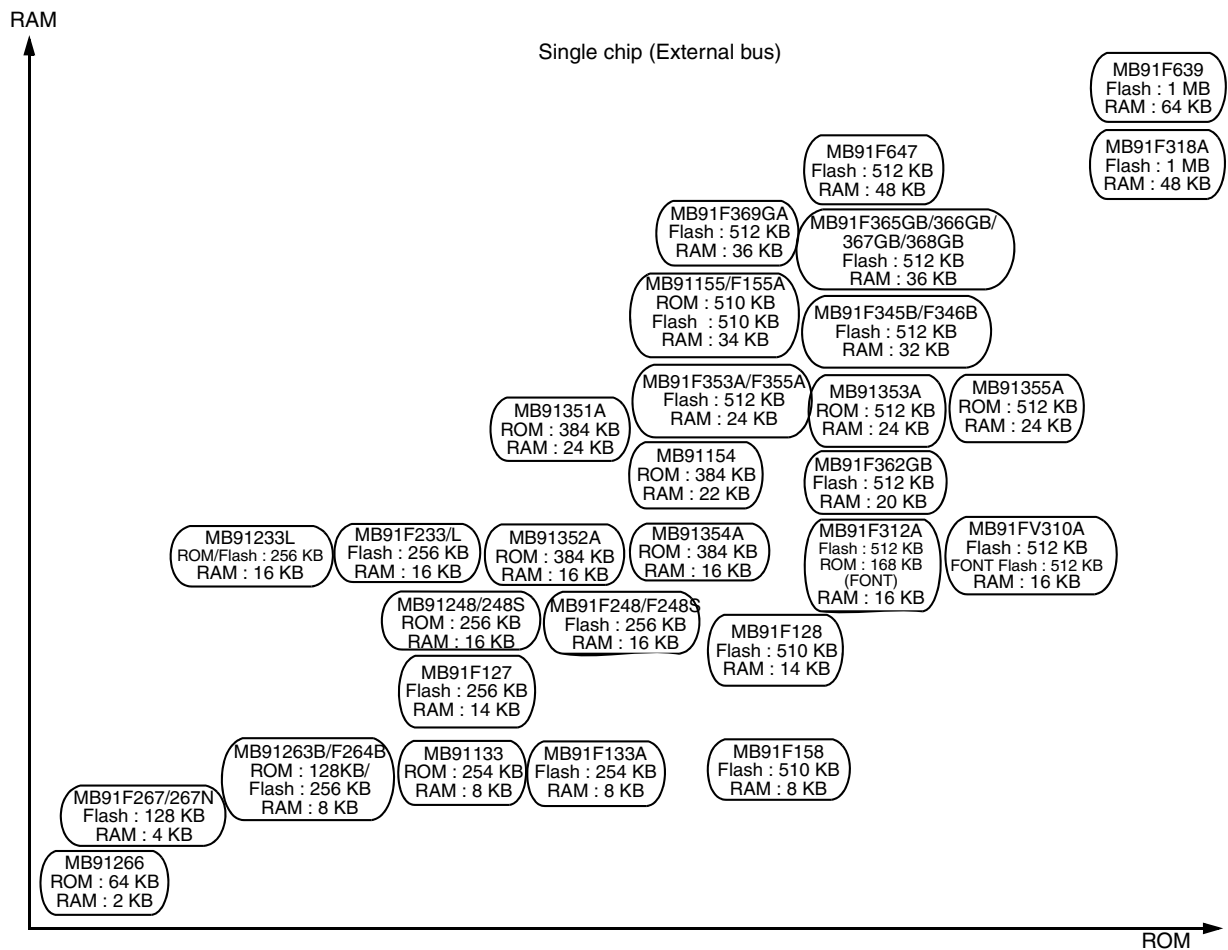
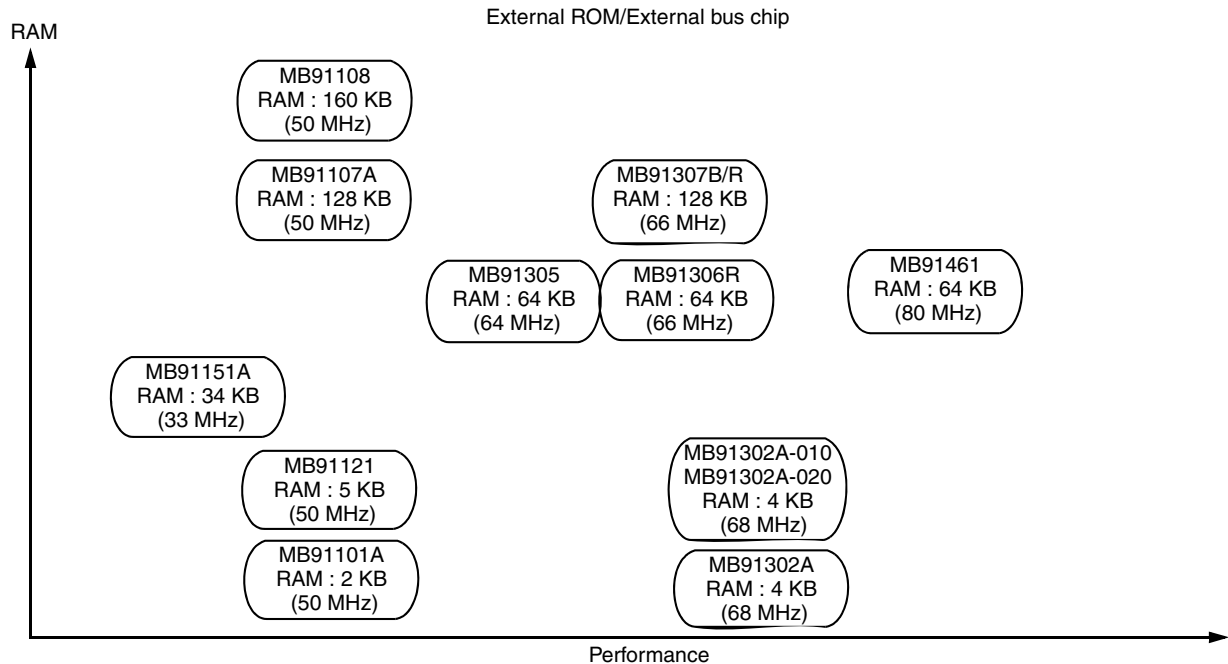

32-bit FR Family

FR Family

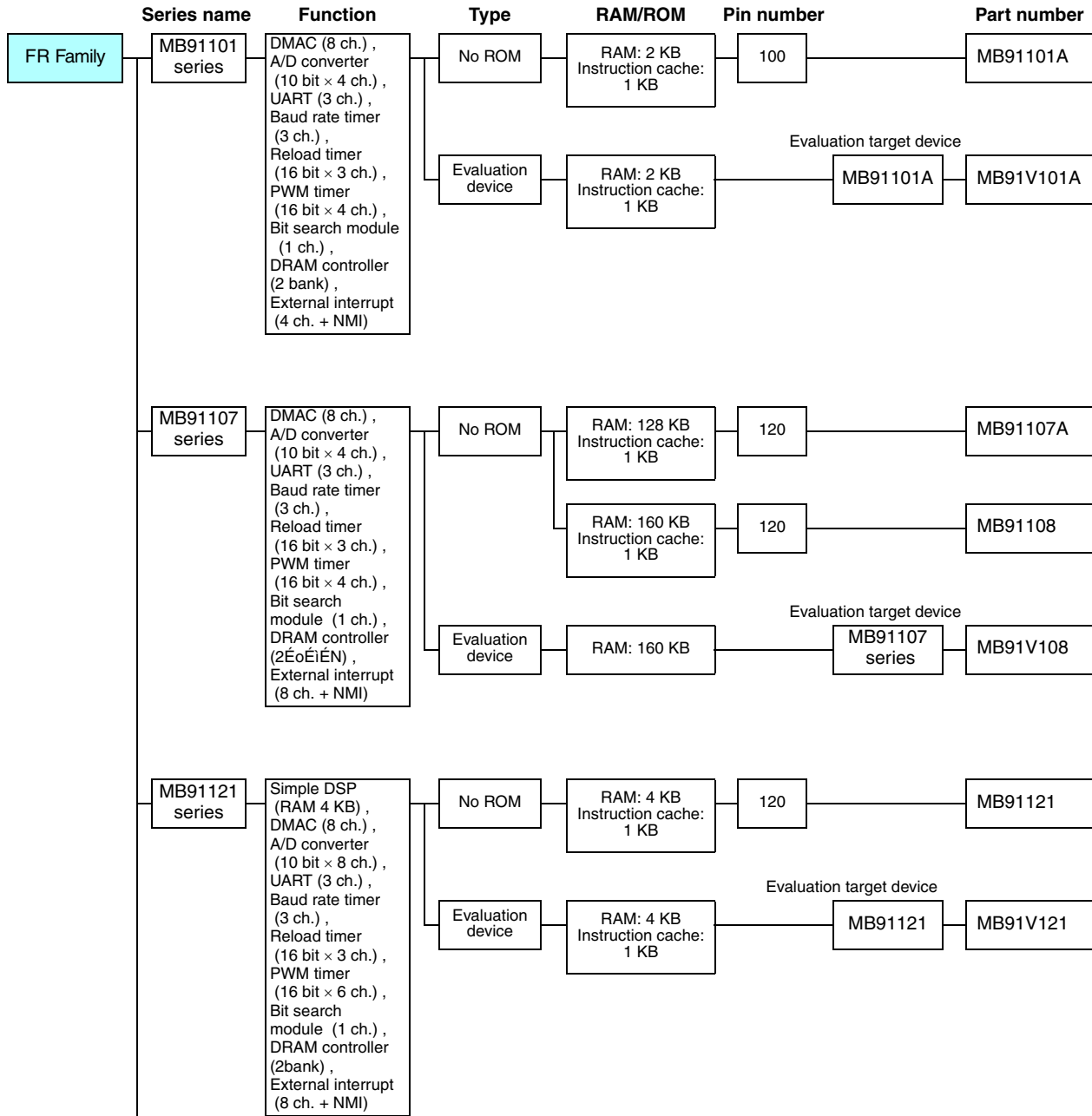

(Continued)

■ MB91101 series

- For external bus, electronic musical instrument, game machine, etc.

MB91101A
RAM: 2 KB
Instruction cache: 1 KB

- Maximum clock frequency : 50 MHz
- Operating temperature range : -40 °C to +70 °C
- Operating power supply voltage : +5 V ± 10% / +3 V ± 10%

Part number	Operating power supply voltage (V)	Package		Functions	
		QFP (0.65 mm)	LQFP (0.5 mm)		
MB91101A	+5 ± 10 % or +3.3 (+3) ± 10 %	100P	100P	Maximum operating frequency : 50 MHz RAM : 2 KB Cache : Instruction cache 1 KB DRAM controller : 2 bank DMA controller : 8 ch. (External 3 ch.) UART/Baud rate timer : 3 ch./3 ch.	A/D converter : 10 bit × 4 ch. PWM timer : 4 ch. Reload timer : 16 bit × 3 ch. Bit search module : 1 ch. External interrupt input : 4 ch. + NMI I/O port : 54 port (multiplex with other signals)

Package: P-plastic

■ MB91107 series

- For DVD player, printer, CD-ROM, etc.

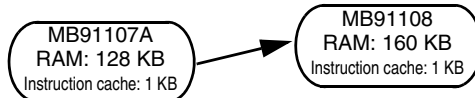

- Maximum clock frequency : 50 MHz
- Operating temperature range : 0 °C to +70 °C
- Operating power supply voltage : +3.3 V ± 0.3 V

Part number	Operating power supply voltage (V)	Package	Functions	
		LQFP (0.5 mm)		
MB91107A	+3.3 ± 0.3	120P	Maximum operating frequency : 50 MHz RAM : 128KB(MB91107A) 160KB(MB91108) Cache : Instruction cache 1 KB DRAM controller : 2 bank DMA controller : 8 ch. (External 3 ch.) UART/Baud rate timer : 3 ch./3 ch.	A/D converter : 10 bit × 4 ch. PWM timer : 4 ch. Reload timer : 16 bit × 3 ch. Bit search module : 1 ch. External interrupt input : 8 ch. + NMI I/O port : 54 port (multiplex with other signals)
MB91108		120P		

Package: P-plastic

■ MB91121 series

- For motor control, printer, DVD player, etc.

MB91121
RAM: 4 KB
Simple DSP

- Maximum clock frequency : 50 MHz
- Operating temperature range : 0 °C to +70 °C
- Operating power supply voltage : +3.3 V ± 0.3 V

Part number	Operating power supply voltage (V)	Package	Functions	
		LQFP (0.5 mm)		
MB91121	+3.3 ± 0.3	120P	Maximum operating frequency : 50 MHz RAM : 4 KB Cache : Instruction cache 1 KB Simple DSP : 16-bit fixed point operations DMA controller : 8 ch.	UART/Baud rate timer : 3 ch./3 ch. A/D converter : 10 bit × 8 ch. PWM timer : 16 bit × 4 ch. Reload timer : 16 bit × 3 ch.

Package: P-plastic

32-bit FR Family

(Continued)

Series name	Function	Type	RAM/ROM	Pin number	Part number
MB91129 series	DMAC (5 ch.), A/D converter (10 bit × 8 ch.), UART (3 ch.), Baud rate timer (3 ch.), Reload timer (16 bit × 3 ch.), PPGtimer (16 bit × 4 ch.), Input capture (16 bit × 4 ch.), Output compare (16 bit × 4 ch.), free-run timer (16 bit × 1 ch.), Bit search module (1 ch.), External interrupt (6 ch. + NMI)	Flash	RAM: 14 KB Flash: 256 KB	100	MB91F127
			RAM: 14 KB Flash: 510 KB	120	MB91F128
		Evaluation device	RAM: 18 KB Flash: 510 KB	Evaluation target device	MB91129 series

MB91130 series	DMAC (8 ch.), UP/DOWN counter (8 bit × 2 ch.), A/D converter (10 bit × 8 ch.), UART (5 ch.), Reload timer (16 bit × 5 ch.), D/A converter (8 bit × 3 ch.), PPGtimer (16 bit × 6 ch.), Input capture (16 bit × 4 ch.), Output compare (16 bit × 8 ch.), free-run counter (16 bit × 1 ch.)	MASK	RAM: 8 KB ROM: 254 KB	144	MB91133
		Flash	RAM: 8 KB Flash: 254 KB	144	MB91F133A
		Evaluation device	RAM: 8 KB Flash: 254 KB	Evaluation target device	MB91130 series

(Continued)

■ MB91129 series

- For mechatronics control, AV, home electric appliances control, etc.

MB91F127
Flash: 256 KB
RAM: 14 KB

MB91F128
Flash: 510 KB
RAM: 14 KB

- Maximum clock frequency : 25 MHz
- Operating temperature range : -30 °C to +70 °C
- Operating power supply voltage : +3.3 V ± 0.3 V

Part number	Operating power supply voltage (V)	Package		Functions
		LQFP (0.5 mm)		
MB91F127	+3.3 ± 0.3	100P		Maximum operating frequency : 25 MHz Flash memory : 256 KB(MB91F127) 510 KB(MB91F128) RAM : 14 KB PPGtimer : 4 ch. DMA controller : 5 ch. Input capture : 16 bit × 4 ch. Output compare : 16 bit × 4 ch. free-run timer : 16 bit × 1 ch. A/D converter : 8/10 bit × 8 ch. Reload timer : 16 bit × 3 ch. UART : 3 ch. External interrupt input : 6 ch.
MB91F128		100P		

Package: P-plastic

■ MB91130 series

- For mechatronics control, AV, home electric appliances control, etc.

MB91133
ROM: 254 KB
RAM: 8 KB

MB91F133A
Flash: 254 KB
RAM: 8 KB

- Maximum clock frequency : 33 MHz
- Operating temperature range : -40 °C to +70 °C
- Operating power supply voltage : +5 V ± 10% / +3.0 V to +3.6 V
+5 V ± 10% / +3.15 V to +3.6 V (MB91F133A)

Part number	Operating power supply voltage (V)	Package		Functions
		LQFP (0.5 mm)	BGA	
MB91133	+5 ± 10% +3.0 to +3.6	144P	144P	Operating frequency : 33 MHz ROM : 254 KB(MB91133) Flash memory : 254 KB(MB91F133A) RAM : 8 KB DMA controller : 8 ch. UP/DOWN counter : 8 bit × 2 ch. A/D converter : 10 bit × 8 ch. (With level comparator : 1 ch.) UART : 5 ch. Reload timer : 16 bit × 5 ch. D/A converter : 8 bit × 3 ch. PPGtimer : 16 bit × 6 ch. Input capture : 16 bit × 4 ch. Output compare : 16 bit × 8 ch. free-run counter : 16 bit × 1 ch.
MB91F133A	+5 ± 10% +3.15 to +3.6	144P	—	

Package: P-plastic

32-bit FR Family

(Continued)

Series name	Function	Type	RAM/ROM	Pin number	Part number		
MB91150 series	DMAC (8 ch.) , UP/DOWN counter (8 bit × 2 ch.) , A/D converter (10 bit × 8 ch.) , UART (4 ch.) , Reload timer (16 bit × 2 ch., 4 ch.) , D/A converter (8 bit × 3 ch.) , PPGtimer (16 bit × 4 ch., 6 ch.) , Input capture (16 bit × 4 ch.) , Output compare (16 bit × 4 ch., 8 ch.) , free-run counter (16 bit × 1 ch.) , RTC (1 ch., no) , I ² C (1 ch., no)	No ROM	RAM: 34 KB Instruction cache : 1KB	144	MB91151A		
		MASK	RAM: 22 KB ROM: 384 KB	144	MB91154		
			RAM: 34 KB ROM: 510 KB	144	MB91155		
		Flash	RAM: 34 KB Flash: 510 KB	144	MB91F155A		
			RAM: 8 KB Flash: 510 KB	120	MB91F158		
		Evaluation device	Evaluation target device		RAM: 34 KB Instruction cache : 1KB	MB91151A	MB91V151A
			RAM: 34 KB Flash: 510 KB	MB91154/155/ F155A/F158	MB91FV150		

(Continued)

■ MB91150 series

- For mechatronics control, AV, home electric appliances control, etc.

- Maximum clock frequency : 33 MHz
- Operating temperature range : 0 °C to +70 °C
- Operating power supply voltage : +3.15 V to +3.6 V
+3.2 V to +3.5 V (MB91F158)



Part number	Operating power supply voltage (V)	Package	Functions	
		LQFP (0.5 mm)		
MB91151A	+3.15 to +3.6	144P	Maximum operating frequency : 33 MHz ROM : 384 KB(MB91154) 510 KB(MB91155) Flash memory : 510 KB(MB91F155A) RAM : 34 KB (MB91151A/155/F155A) 22 KB (MB91154) Cache: Instruction cache: 1 KB (MB91151A) DMA controller : 8 ch. UP/DOWN counter : 8 bit × 2 ch. A/D converter : 10 bit × 8 ch.	UART : 4 ch. Reload timer : 16 bit × 4 ch. D/A converter : 8 bit × 3 ch. PPGtimer : 16 bit × 6 ch. Input capture : 16 bit × 4 ch. Output compare : 16 bit × 8 ch. free-run timer : 16 bit × 1 ch. I ² C : 1 ch. (MB91154/155/F155A) RTC : 1 ch. (MB91154/155/F155A)
MB91154		144P		
MB91155		144P		
MB91F155A		144P		
MB91F158	+3.2 to +3.5	120P	Operating frequency : 33 MHz Flash memory : 510 KB RAM : 8 KB UP/DOWN counter : 8 bit × 2 ch. A/D converter : 10 bit × 8 ch. UART : 2 ch.	Reload timer : 16 bit × 2 ch. D/A converter : 8 bit × 3 ch. PPGtimer : 16 bit × 4 ch. Input capture : 16 bit × 4 ch. Output compare : 16 bit × 4 ch. free-run timer : 16 bit × 1 ch.

Package: P-plastic

32-bit FR Family

(Continued)

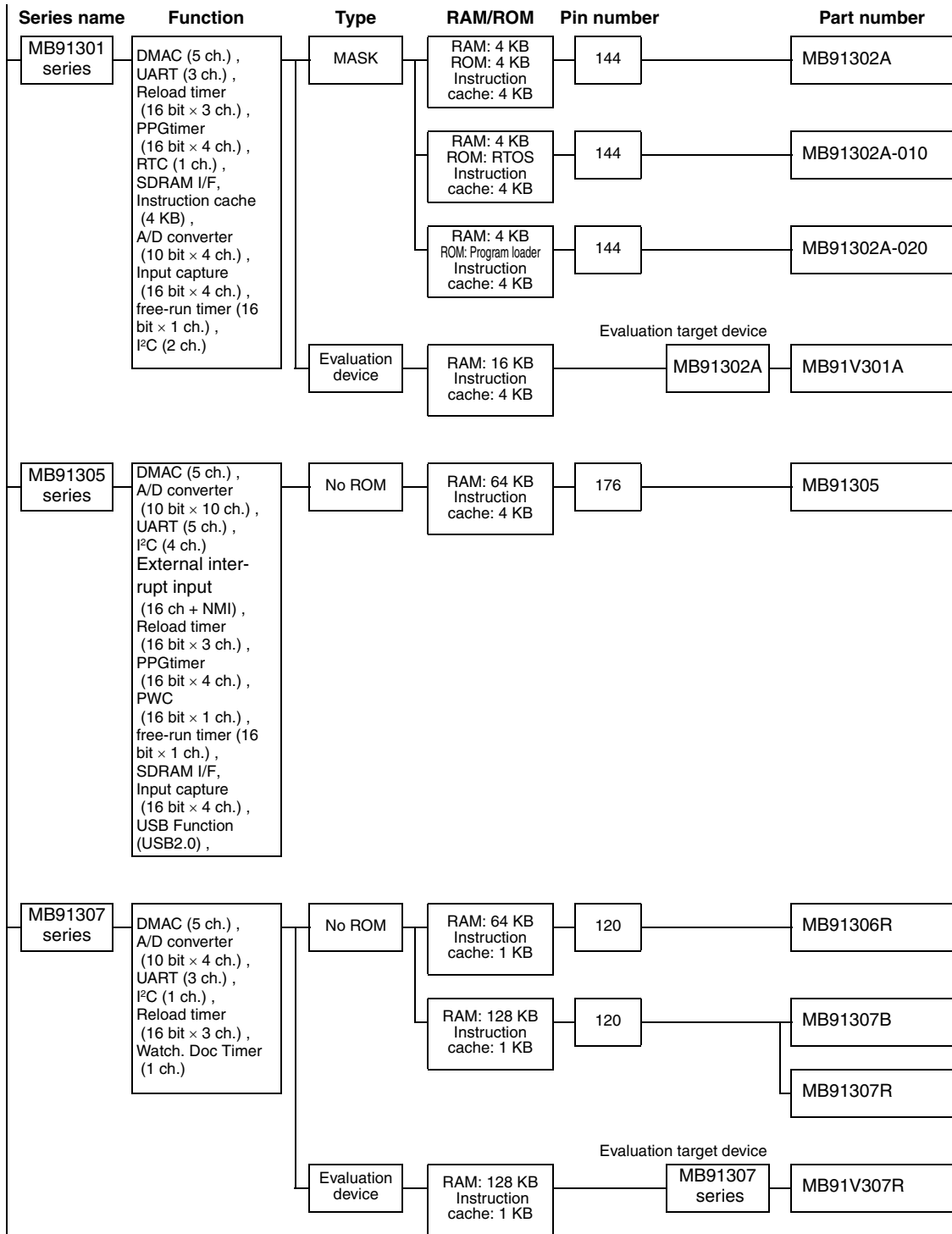

(Continued)

MB91301 series

- For printer, FAX, image processing, etc.

MB91302A ROM: 4 KB RAM: 4 KB	MB91302A-010 ROM: RTOS RAM: 4 KB	MB91302A-020 ROM: Program loader RAM: 4 KB
------------------------------------	--	--

- Maximum clock frequency : 68 MHz
- Operating temperature range : 0 °C to +70 °C
- Operating power supply voltage: +3.0 V to +3.6 V

Part number	Operating power supply voltage (V)	Package	Functions	
		LQFP (0.4 mm)		
MB91302A	+3.3 ± 0.3	144P	Maximum operating frequency : 68 MHz RAM : 4 KB ROM : 4 KB (MB91302A) RTOS (MB91302A-010) Program loader (MB91302A-020) Instruction cache : 4 KB UART : 3 ch. External interrupt input : 9 ch.	I ² C : 2 ch. Input capture : 16 bit × 4 ch. SDRAM I/F DMA controller : 5 ch. PPGtimer : 16 bit × 4 ch. A/D converter : 10 bit × 4 ch. Reload timer : 16 bit × 3 ch. Bit search module
MB91302A-010		144P		
MB91302A-020		144P		

Package: P-plastic

*1: Since the μ ITRON3.0 kernel and main system calls are built-in ROM, a high real-time system is realizable.

*2: Since ROM only for program loader is built-in, the rewriting program in an external flash memory can be transmitted to RAM, and can be performed.

MB91305 series

- For TV control, home electric appliances control, etc.

MB91305 RAM: 64 KB Instruction cache : 4 KB

- Maximum clock frequency : 64 MHz
- Operating temperature range : 0 °C to +70 °C
- Operating power supply voltage: +3.0 V to +3.6 V, +1.65 V to +1.95 V

Part number	Operating power supply voltage (V)	Package	Functions	
		LQFP (0.5 mm)		
MB91305	+3.3 ± 0.3 +1.8 ± 0.15	176P	Maximum operating frequency : 64 MHz Cache : Instruction cache : 4 KB RAM : 64 KB DMAC : 5 ch. A/D converter : 10 bit × 10 ch. UART : 5 ch. I ² C : 4 ch. External interrupt input : 16 ch. + NMI	Reload timer : 16 bit × 3 ch. PPG timer : 16 bit × 4 ch. PWC timer : 16 bit × 1 ch. free-run timer : 16 bit × 1 ch. Input capture : 16 bit × 4 ch. USB-Function : USB2.0 Watch DOG Timer

Package: P-plastic

MB91307 series

- For FAX, printer, DVD player, etc.

MB91306R RAM: 64 KB Instruction cache : 1 KB Twin 3.3/1.8 V	MB91307B RAM: 128 KB Instruction cache : 1 KB Single 3.3 V	MB91307R RAM: 128 KB Instruction cache : 1 KB Twin 3.3/1.8 V
--	---	---

- Maximum clock frequency : 66 MHz
- Operating temperature range : 0 °C to +70 °C
- Operating power supply voltage:
 - MB91307B +3.0 V to +3.6 V
 - MB91306R/307R +3.0 V to +3.6 V, +1.65 V to +1.95 V

Part number	Operating power supply voltage (V)	Package	Functions	
		LQFP (0.5 mm)		
MB91306R	+3.3 ± 0.3 +1.8 ± 0.15	120P	Maximum operating frequency : 66 MHz RAM : 64 KB (MB91306R) 128 KB (MB91307B/307R) Cache : Instruction cache 1 KB UART : 3 ch. External interrupt input : 9 ch.	I ² C : 1 ch. U-Timer : 3 ch. Reload timer : 16 bit × 3 ch. A/D converter : 10 bit × 4 ch. Watch DOG Timer DMAC : 5 ch. (External 3 ch.)
MB91307B	+3.3 ± 0.3	120P		
MB91307R	+3.3 ± 0.3 +1.8 ± 0.15	120P		

Package: P-plastic

32-bit FR Family

(Continued)

Series name	Function	Type	RAM/ROM	Pin number	Part number
MB91310 series	DMAC (5 ch.) , A/D converter (10 bit × 10 ch.) , UART (5 ch.) , U-Timer (5 ch.) , I ² C (4 ch.) Reload timer (16 bit × 3 ch.) , PPG timer (16 bit × 4 ch.) , PWC (16 bit × 1 ch.) , Multifunction timer (4 ch.) , USB host (USB 1.0) , USB function (USB 1.1) , OSDC, Bit search module (4 ch.) External interrupt input (5 ch.)	Flash	RAM: 16 KB Flash: 512 KB FONT ROM: 168 KB	144	MB91F312A
MB91313 series	DMAC (5 ch.) , A/D converter (10 bit × 10 ch.) , Multi function serial interface (11 ch.) , Reload timer (16 bit × 6 ch.) , PWC (16 bit × 1 ch.) , PPG timer (16 bit × 4 ch.) , Multifunction timer (4 ch.) , HDMI-CEC (2 ch.) , Bit search module (1 ch.) External interrupt input (24 ch. + NMI)	Flash/ Evaluation device	RAM: 32 KB Flash: 544 KB	126	MB91F313

(Continued)

■ MB91310 series

- For TV, PDP control, home electric appliances control, etc.

MB91F312A
Flash: 512 KB
FONT ROM: 168 KB
RAM: 16 KB

- Maximum clock frequency : 40 MHz
- Operating temperature range : -10 °C to +70 °C
- Operating power supply voltage : +3.0 V to +3.6 V
+2.35 V to +2.65 V

Part number	Operating power supply voltage (V)	Package	Functions
		LQFP (0.5 mm)	
MB91F312A	+3.3 ± 0.3 +2.5 ± 0.15	144P	Maximum operating frequency : 40 MHz Flash memory : 512 KB FONT ROM : 168 KB (MB91F312A) FONT Flash memory : 512 KB (MB91FV310A) RAM : 16 KB A/D converter : 10 bit × 10 ch. External interrupt input : 5 ch. UART : 5 ch PPG : 16 bit × 4 ch. Multifunction timer : 4 ch. (Interval timer, event count, capture) Reload timer : 16 bit × 3 ch. PWC timer : 16 bit × 1 ch. I ² C : 4 ch. USB host : USB1.0 USB function : USB1.1 OSDC Watch DOG Timer Bit search module : 4 ch.

Package: P-plastic

■ MB91313 series

- For TV control, home electric appliances control, etc.

MB91F313
Flash : 544 KB
RAM : 32 KB

- Maximum clock frequency : 33 MHz
- Operating temperature range : -40 °C to +85 °C
- Operating power supply voltage : +3.0 V to +3.6 V
+1.65 V to +1.95 V

Part number	Operating power supply voltage (V)	Package	Functions
		LQFP (0.5 mm)	
MB91F313	+3.0 to +3.6 +1.65 to +1.95	120P	Maximum operating frequency : 33 MHz Flash memory : 544 KB RAM : 32 KB DMA Controller : 5 ch. A/D converter : 10 bit × 10 ch. Multifunction serial interface (UART/SIO/I ² C) : 11 ch. Reload timer : 16 bit × 6 ch. PWC timer : 16 bit × 1 ch. PPG : 16 bit × 4 ch. Multifunction timer : 4 ch. (Interval timer, event count, capture) HDMI-CEC : 2 ch Bit search module External interrupt input : 24 ch. Watch DOG Timer Watch timer

Package: P-plastic

32-bit FR Family

(Continued)

Series name	Function	Type	RAM/ROM	Pin number	Part number
MB91314A series	DMAC (5 ch.) , A/D converter (10 bit × 10 ch.) , Multi function serial interface (11 ch.) , Reload timer (16 bit × 6 ch.) , PPG timer (16 bit × 4 ch.) , PWC (16 bit × 1 ch.) , Multifunction timer (16 bit × 4 ch.) , Closed caption decoder function (1 ch.) External interrupt input (24 ch.)	MASK	RAM : 32 KB ROM : 256 KB	120	MB91314A
		Flash	RAM : 32 KB Flash : 512 KB	120	MB91F314A
MB91319 series	DMAC (5 ch.) , A/D converter (10 bit × 10 ch.) , UART (5 ch.) , U-Timer (5 ch.) , I ² C (4 ch.) Reload timer (16 bit × 3 ch.) , PPG timer (16 bit × 4 ch.) , PWC (16 bit × 1 ch.) , Multifunction timer (4 ch.) , USB function (USB 2.0) , OSDC , OSDC for CC CCD (2 ch.) Bit search module (1 ch.) External interrupt input (4 ch. + NMI)	ROM	RAM: 32 KB ROM: 512 KB FONT ROM: 384 KB	176	MB91316A
		Flash	RAM: 48 KB Flash: 1 MB FONT ROM: 384 KB	176	MB91F318R
		Evaluation device	RAM: 128 KB Flash: 1 MB Flash: 512 KB		Evaluation target device MB91319 series

(Continued)

■ MB91314A series

- For TV control, home electric appliances control, etc.

MB91314A
ROM: 512 KB
RAM: 32 KB

MB91F314A
Flash: 512 KB
RAM: 32 KB

- Maximum clock frequency : 33 MHz
- Operating temperature range : -10 °C to +70 °C
- Operating power supply voltage : +3.0 V to +3.6 V
+1.65 V to +1.95 V

Part number	Operating power supply voltage (V)	Package	Functions
		LQFP (0.5 mm)	
MB91314A	+3.0 to +3.6 +1.65 to +1.95	120P	Maximum operating frequency : 33 MHz ROM : 256 KB (MB91314A) Flash memory : 512 KB (MB91F314A) RAM : 32 KB DMA Controller : 5 ch.
MB91F314A		120P	A/D converter : 10 bit × 10 ch. Multifunction serial interface (UART/SIO/I ² C) : 11 ch. Reload timer : 16 bit × 6 ch. PPG : 16 bit × 4 ch. PWC timer : 16 bit × 1 ch. Multifunction timer : 4 ch. (Interval timer, event count, capture) Closed caption decoder function : 1 ch External interrupt input : 24 ch. Bit search module Watch DOG Timer

Package: P-plastic

■ MB91319 series

- For TV, PDP control, home electric appliances control, etc.

MB91316A
ROM: 512 KB
FONT ROM: 384 KB
RAM: 32 KB

MB91F318R
Flash: 1 MB
FONT ROM: 384 KB
RAM: 48 KB

- Maximum clock frequency : 40 MHz
- Operating temperature range : -10 °C to +70 °C
- Operating power supply voltage : +3.3 ± 0.3 V/+1.8 ± 0.15 V

Part number	Operating power supply voltage (V)	Package	Functions
		LQFP (0.5 mm)	
MB91316A	+3.0 to +3.6 +1.65 to +1.95	176P	Maximum operating frequency : 40 MHz Flash memory : 1 MB (MB91F318R/FV319R) ROM : 512 KB (MB91316A) FONT ROM : 384 KB (MB91316A/F318R) FONT Flash memory : 512 KB (MB91FV319R) RAM : 32 KB (MB91316A) 48 KB (MB91F318R) 64 KB (MB91FV319R)
MB91F318R		176P	A/D converter : 10 bit × 10 ch. External interrupt input : 5 ch. UART : 5 ch. Multifunction timer : 4 ch. (Interval timer, event count, capture)

Package: P-plastic

32-bit FR Family

(Continued)

Series name	Function	Type	RAM/ROM	Pin number	Part number		
MB91350A series	DMAC (5 ch.), UP/DOWN counter (8 bit × 1 ch.), A/D converter (10 bit × 8 ch.), SIO (2 ch.), UART (4 ch.), Reload timer (16 bit × 4 ch.), D/A converter (8 bit × 2 ch.), PPGtimer (16 bit × 3 ch.), Input capture (16 bit × 4 ch.), Output compare (16 bit × 2 ch.), free-run timer (16 bit × 1 ch.), I ² C (1 ch.)	MASK	RAM: 24 KB ROM: 384 KB	120	MB91351A		
			RAM: 16 KB ROM: 384 KB	120	MB91352A		
			RAM: 24 KB Flash: 512 KB	120	MB91353A		
		Flash	RAM: 24 KB Flash: 512 KB	120	MB91F353A		
		Evaluation device	RAM: 16 KB DATA RAM: 16 KB	Evaluation target device		MB91350A series	MB91V350A
		DMAC (5 ch.), UP/DOWN counter (8 bit × 2 ch.), A/D converter (10 bit × 12 ch.), SIO (3 ch.), UART (5 ch.), Reload timer (16 bit × 4 ch.), D/A converter (8 bit × 3 ch.), PPGtimer (16 bit × 6 ch.), Input capture (16 bit × 4 ch.), Output compare (16 bit × 8 ch.), free-run timer (16 bit × 1 ch.), I ² C (1 ch.)	MASK	RAM: 16 KB ROM: 384 KB	176	MB91354A	
				RAM: 24 KB ROM: 512 KB	176	MB91355A	
			Flash	RAM: 24 KB Flash: 256 KB	176	MB91F356B	
				RAM: 24 KB Flash: 512 KB	176	MB91F355A	
			Evaluation device	RAM: 32 KB DATA RAM: 16 KB	Evaluation target device		MB91350A series

(Continued)

■ MB91350A series

- For mechatronics control, AV, home electric appliances control, etc.

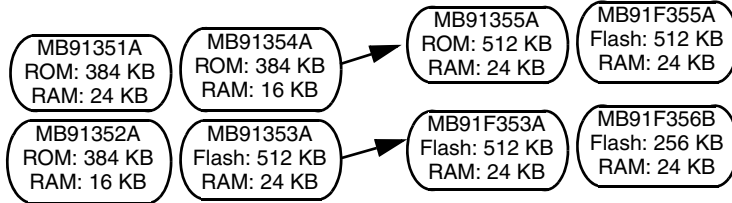

- Maximum clock frequency : 50 MHz
- Operating temperature range : -40 °C to +85 °C
- Operating power supply voltage : +3.0 V to +3.6 V

Part number	Operating power supply voltage (V)	Package	Functions	
		LQFP (0.5 mm)		
MB91351A	+3.3 ± 0.3	120P	Maximum operating frequency : 50 MHz RAM : 8 KB	D/A converter : 8 bit × 2 ch. DMAC : 5 ch. Input capture : 16 bit × 4 ch.
MB91352A		120P	ROM : 384 KB (MB91351A/352A) Flash memory : 512 KB (MB91F353A)	Output compare : 16 bit × 2 ch. Watch. DOG Timer
MB91353A		120P	DATA RAM : 8 KB (MB91352A) 16 KB (MB91351A/F353A)	Reload timer : 16 bit × 4 ch. free-run timer : 16 bit × 1 ch.
MB91F353A		120P	UART : 4 ch. External interrupt input : 9 ch. I ² C : 1 ch. A/D converter : 10 bit × 8 ch.	UP/DOWN counter : 8 bit × 1 ch. SIO : 1 ch. PPG : 16 bit × 3 ch.
MB91354A		176P	Maximum operating frequency : 50 MHz RAM : 8 KB	D/A converter : 8 bit × 3 ch. DMAC : 5 ch.
MB91355A		176P	ROM : 384 KB (MB91354A) 512 KB (MB91355A)	Input capture : 16 bit × 4 ch. Output compare : 16 bit × 8 ch.
MB91F355A		176P	Flash memory : 256 KB (MB91F356B) 512 KB (MB91F355A)	Watch. DOG Timer Reload timer : 16 bit × 4 ch.
MB91F356B		176P	DATA RAM : 8 KB (MB91354A) 16 KB (MB91355A/F355A/F356B)	free-run timer : 16 bit × 1 ch. UP/DOWN counter : 8 bit × 2 ch. SIO : 3 ch. PPG : 16 bit × 6 ch.

Package: P-plastic

32-bit FR Family

(Continued)

Series name	Function	Type	RAM/ROM	Pin number	Part number
MB91210 series	CAN controller (3 ch.), LIN-UART (7 ch.), A/D converter (10 bit × 32 ch.), Reload timer (16 bit × 3 ch.), PPG timer (16 bit × 8 ch.), Input capture (16 bit × 8 ch.), Output compare (16 bit × 8 ch.), Free-run timer (16 bit × 4 ch.), DMAC (5 ch.), External interrupt input (16 ch.), Real time clock	MASK	RAM : 24 KB ROM : 544 KB	144	MB91213A
		Flash	RAM : 16 KB Flash : 288 KB	100	MB91F211B
			RAM : 24 KB Flash : 544 KB	144	MB91F213A
		Evaluation device	RAM : 36 KB	MB91210 series	MB91V210
Evaluation target device					
MB91220 series	CAN controller (2 ch.), LIN-UART (4 ch.), I ² C (2 ch.), A/D converter (10 bit × 24 ch.), D/A converter (8 bit × 2 ch.), Reload timer (16 bit × 3 ch.), PPG timer (16 bit × 16 ch.), Input capture (16 bit × 4 ch.), Output compare (16 bit × 2 ch.), Free-run timer (16 bit × 2 ch.), PWC timer (16 bit × 1 ch.), DMAC (5 ch.), External interrupt input (8 ch.), Stepping motor controller (4 ch.), Sound generator (3 ch.), Real time clock	Flash	RAM : 16 KB ROM : 512 KB	144	MB91F223
					MB91F223S
		Evaluation device	RAM : 64 KB	MB91220 series	MB91V220B
Evaluation target device					

(Continued)

■ MB91210 series (FR60Lite)

- For automotive products, etc.

MB91213A ROM : 544 KB RAM : 24 KB	MB91F211B Flash : 288 KB RAM : 16 KB	MB91F213A Flash : 544 KB RAM : 24 KB
---	--	--

- Maximum clock frequency : 40 MHz
- Operating temperature range : -40 °C to +105 °C
- Operating power supply voltage : +3.5 V to +5.5 V

Part number	Operating power supply voltage (V)	Package	Functions
		LQFP	
MB91213A	+3.5 to +5.5	144P	Maximum operating frequency : 40 MHz Flash memory : 544 KB (MB91F213A), 288 KB (MB91F211B) ROM : 544 KB (MB91213A) RAM : 24 KB (MB91F213A/MB91213A) 16 KB (MB91F211B) DMA controller : 5 ch. A/D converter : 10 bit × 32 ch. (MB91F213A/MB91213A) 10 bit × 16 ch. (MB91F211B) CAN interface (32 message buffer) : 3 ch. (MB91F213A/MB91213A) 1 ch. (MB91F211B) LIN-UART : 7 ch. (MB91F213A/MB91213A), LIN 4 ch. + no LIN : 1 ch. (MB91F211B)
MB91F213A			
MB91F211B		100P	

Package: P-plastic

■ MB91220 series (FR60Lite)

- For automotive products, etc.

MB91F223/S Flash : 512 KB RAM : 16 KB

- Maximum clock frequency : 32 MHz
- Operating temperature range : -40 °C to +105 °C
- Operating power supply voltage : +3.5 V to +5.5 V

Part number	Operating power supply voltage (V)	Package	Functions
		LQFP	
MB91F223	+3.5 to +5.5	144P	Maximum operating frequency : 32 MHz Flash memory : 512 KB RAM : 16KB DMA controller : 5 ch. A/D converter : 10bit × 24 ch. CAN interface (32 message buffer) : 2 ch. LIN-UART : 4 ch. I ² C : 2 ch. Reload timer : 16 bit × 3 ch.
MB91F223S			

Package: P-plastic

32-bit FR Family

(Continued)

Series name	Function	Type	RAM/ROM	Pin number	Part number
MB91230 series	UP/DOWN counter (8 bit × 2 ch.), A/D converter (10 bit × 8 ch.), UART (4 ch.), Reload timer (16 bit × 4 ch.), D/A converter (8 bit × 2 ch.), PPG timer (16 bit × 6 ch.), Input capture (16 bit × 2 ch.), Output compare (16 bit × 4 ch.), free-run timer (16 bit × 1 ch.), RTC (1 ch.), LCD controller (4 com × 32 seg)	MASK	RAM: 16 KB ROM: 256 KB	120	MB91233L
		Flash	RAM: 16 KB Flash: 256 KB	120	MB91F233 MB91F233L
		Evaluation device	RAM: 24 KB		Evaluation target device MB91230 series MB91V230
MB91245 series	CAN controller (2 ch.), UART for LIN (3 ch.), UART (1 ch.), LCD controller (4 com × 32 seg) Stepping motor controller (6 ch.), A/D converter (10 bit × 32 ch.), Reload timer (16 bit × 3 ch.), PPG timer (16 bit × 4 ch.), Input capture (16 bit × 4 ch.), PWC timer (16 bit × 1 ch.), Output compare (16 bit × 2 ch.), free-run timer (16 bit × 2 ch.), RTC Sound generator (3 ch.), DMAC (5 ch.), External interrupt input (8 ch.)	MASK	RAM: 16 KB ROM: 256 KB	120	MB91248 * MB91248S *
		Flash	RAM: 16 KB Flash: 256 KB	120	MB91F248 MB91F248S
		Evaluation device	RAM: 32 KB		Evaluation target device MB91245 series MB91V245A

*: Underdevelopment

(Continued)

■ MB91230 series (FR60Lite)

- For camera, IC recorder, home electric appliances control, etc.



- Maximum clock frequency : 33.6 MHz
- Operating temperature range : -40 °C to +85 °C
- Operating power supply voltage
 - MB91F233/V230: +4.0 V to +5.25 V (External)
 - +3.0 V to +3.6 V (Internal)
 - MB91233L/F233L: +3.0 V to +3.6 V
 - A/D, D/A input: +3.0 V to +3.6 V

Part number	Operating power supply voltage (V)	Package		Functions
		LQFP (0.4 mm)	FLGA	
MB91233L	+3.0 to +3.6	120P	120P Under development	Maximum operating frequency : 33 MHz RAM : 16 KB ROM : 256 KB (MB91233L) Flash memory : 256 KB (MB91F233/F233L) A/D converter : 10 bit × 8 ch. D/A converter : 8 bit × 2 ch. External interrupt input : 16 ch. UART : 4 ch. PPG : 16 bit × 6 ch.
MB91F233	+4.0 to +5.25 (External) +3.0 to +3.6 (Internal)	120P	—	
MB91F233L	+3.0 to +3.6	120P	120P Under development	

Package: P-plastic

■ MB91245 series (FR60Lite)

- For automotive products, display control, etc.

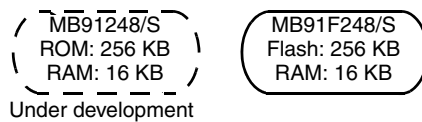

- Maximum clock frequency : 32 MHz
- Operating temperature range : -40 °C to +105 °C
- Operating power supply voltage : +3.5 V to +5.5 V

Part number	Operating power supply voltage (V)	Package		Functions
		LQFP		
◎MB91248 *2	+3.5 to +5.5	144P		Reload timer : 16 bit × 3 ch. PPG timer : 16 bit × 4 ch. (8 bit × 8 ch.) Input capture : 16 bit × 4 ch. Output compare : 16 bit × 2 ch. free-run timer : 16 bit × 2 ch. PWC counter : 16 bit × 1 ch. Timebase timer (WDT) : 16 bit × 1 ch. Real time clock Sound generator : 1 ch. External interrupt input : 8 ch. Low-power consumption modes : sleep, stop, watch mode
◎MB91248S *1		144P		
MB91F248 *2		144P		
MB91F248S *1		144P		

Package: P-plastic

◎: Under development

*1 : single clock

*2 : dual clock

32-bit FR Family

(Continued)

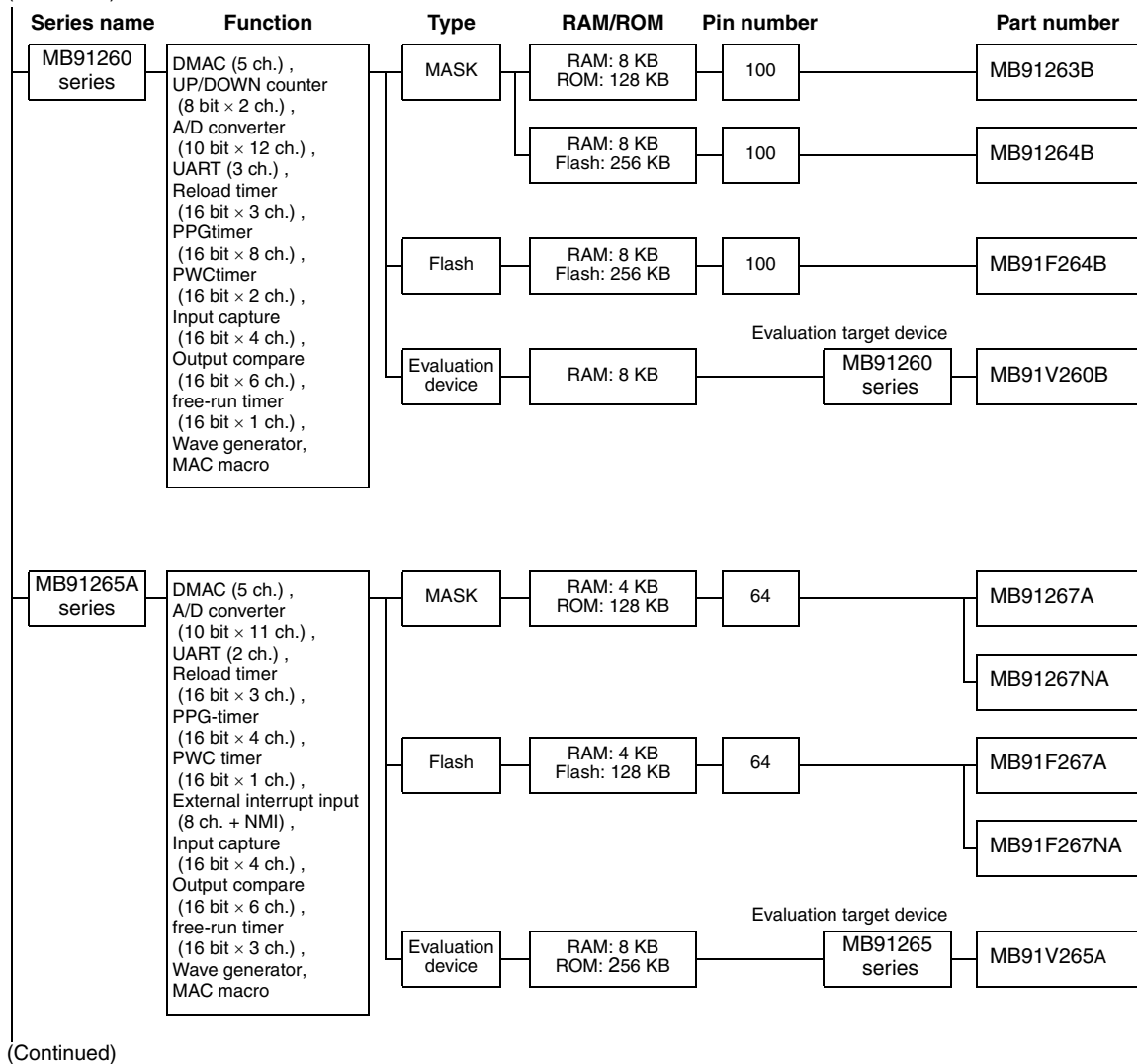

(Continued)

■ MB91260 series (FR60Lite)

- For Motor control application (Inverter control) (Refrigerator, Air conditioner, Cleaner, IH cooking Heater etc.)



- Maximum clock frequency : 33 MHz
- Operating temperature range : -40 °C to +85 °C
- Operating power supply voltage: +4.0 V to +5.5 V

Part number	Operating power supply voltage (V)	Package		Functions
		LQFP (0.5 mm)	QFP	
MB91263B	+4.0 to +5.5	100P	100P	Maximum operating frequency : 33 MHz Flash memory : 256 KB (MB91F264B) ROM: 128 KB (MB91263B) 256 KB (MB91264B) RAM : 8 KB DMA controller : 5 ch. A/D converter : 10bit × 12 ch. UART : 3 ch. Reload timer : 16 bit × 3 ch. PPGtimer : 16 bit × 8 ch. PWCtimer : 16 bit × 2 ch. External interrupt input : 10 ch. Input capture : 16 bit × 4 ch. Output compare : 16 bit × 6 ch. free-run timer : 16 bit × 1 ch. Wave generator (for motor drive) MAC (Multiplication and Addition Calculator) macro
MB91264B		100P	100P	
MB91F264B		100P	100P	

Package: P-plastic

■ MB91265A series (FR60Lite)

- For Motor control application (Inverter control) (Refrigerator, Air conditioner, Cleaner, IH cooking Heater etc.)

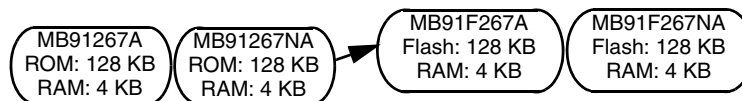

- Maximum clock frequency : 33 MHz
- Operating temperature range : -40 °C to +85 °C
- Operating power supply voltage: +4.0 V to +5.5 V

Part number	Operating power supply voltage (V)	Package		Functions
		LQFP (0.65 mm)		
MB91267A	+4.0 to +5.5	64P		Maximum operating frequency : 33 MHz Flash memory : 128 KB (MB91F267A/F267NA) ROM : 128 KB (MB91267A/267NA) RAM : 4 KB (MB91F267A/F267NA) DMA controller : 5 ch. A/D converter : 10 bit × 11 ch. CAN interface (32 message buffer) : 1 ch. (MB91F267NA) UART : 2 ch. Reload timer : 16 bit × 3 ch. PPG timer : 16 bit × 4 ch. PWC timer : 16 bit × 1 ch. External interrupt input : 8 ch. Input capture : 16 bit × 4 ch. Output compare : 16 bit × 6 ch. free-run timer : 16 bit × 3 ch. Timebase timer (WDT) : 16 bit × 1 ch. Wave generator (for motor drive) MAC (Multiplication and Addition Calculator) macro Low-power consumption modes: sleep, stop, watch mode
MB91267NA				
MB91F267A				
MB91F267NA				

Package: P-plastic

32-bit FR Family

(Continued)

Series name	Function	Type	RAM/ROM	Pin number	Part number	
MB91270 series	CAN controller (1 ch.), UART for LIN (7 ch.), I ² C interface (3 ch.), A/D converter (10 bit × 24 ch.), Reload timer (16 bit × 3 ch.), PPG timer (16 bit × 8 ch.), Input capture (16 bit × 8 ch.), Output compare (16 bit × 8 ch.), free-run timer (16 bit × 4 ch.), RTC Sound generator (3 ch.), Up/down counter (2 ch.), DMAC (5 ch.), External interrupt input (16 ch.)	Flash	RAM: 10 KB Flash: 256 KB	100	MB91F272 **	
						MB91F272S **
						MB91F277 **
						MB91F277S **
			RAM: 24 KB Flash: 512 KB	100	MB91F273	
					MB91F273S	
					MB91F278 **	
			MB91F278S **			
		Evaluation device	RAM: 48 KB	Evaluation target device	MB91270 series	MB91V280
MB91345 series	DMAC (5 ch.), A/D converter (10 bit × 8 ch. × 2 unit), Multi function serial interface (11 ch.), Reload timer (16 bit × 3 ch.), PPG timer (16 bit × 8 ch.), PWC timer (16 bit × 1 ch.), External interrupt input: 24 ch. + NMI Input capture (16 bit × 4 ch., 32 bit × 4 ch.), Output compare (16 bit × 4 ch., 32 bit × 4 ch.), free-run timer (16 bit × 1 ch., 16 bit × 1 ch.), Up/down counter (16 bit × 2 ch.)	Flash	RAM: 32 KB Flash: 512 KB	100	MB91F345B	
			RAM: 32 KB Flash: 1 MB	100	MB91F346B *	

*: Under development

** : Under planning

(Continued)

■ MB91270 series (FR60Lite)

- For automotive products, etc.

MB91F272/S
Flash: 256 KB
RAM: 10 KB
Under planning

MB91F277/S
Flash: 512 KB
RAM: 24 KB
Under planning

MB91F273/S
Flash: 512 KB
RAM: 24 KB

MB91F278/S
Flash: 512 KB
RAM: 24 KB
Under planning

- Maximum clock frequency : 32 MHz
- Operating temperature range : -40 °C to +105 °C
- Operating power supply voltage : +3.5 V to +5.5 V

Part number	Operating power supply voltage (V)	Package		Functions
			LQFP	
○MB91F272 *2	+3.5 to +5.5		100P	Maximum operating frequency : 32 MHz RAM : 10 KB (MB91F272/F272S/F277/F277S) 24 KB (MB91F273/F273S/F278/F278S) Flash memory : 256 KB (MB91F272/F272S/F277/F277S) 512 KB (MB91F273/F273S/F278/F278S) DMAC : 5 ch. CAN interface (32 message buffer) : 1 ch. UART for LIN : 7 ch. I ² C interface : 3 ch. A/D converter : 10 bit × 24 ch. Reload timer : 16 bit × 3 ch. Input capture : 16 bit × 8 ch.
○MB91F272S *1			100P	
MB91F273 *2			100P	
MB91F273S *1			100P	
○MB91F277 *2			100P	
○MB91F277S *1			100P	
○MB91F278 *2			100P	
○MB91F278S *1			100P	

Package: P-plastic

*1 : single clock, *2 : dual clock

○: Under planning

■ MB91345 series (FR60Lite)

- For audio-visual equipment, home electric equipment, mechatronics control, etc.

MB91F345B
Flash: 512 KB
RAM: 32 KB

MB91F346B
Flash: 1 MB
RAM: 32 KB

- Maximum clock frequency : 50 MHz
- Operating temperature range : -40 °C to +85 °C
- Operating power supply voltage : +3.0 V to +3.6 V

Part number	Operating power supply voltage (V)	Package		Functions
		TQFP (0.4 mm)	LQFP (0.5 mm)	
MB91F345B	+3.0 to +3.6	100P	100P	Maximum operating frequency : 50 MHz Flash memory : 512 KB (MB91F345B) 1 MB (MB91F346B) RAM : 32 KB DMA controller : 5 ch. 10bit A/D converter : 8 ch. × 2 unit Multi function serial interface (UART/SIO/I ² C) : 11 ch. 2 channels are with built-in FIFO. Reload timer : 16 bit × 3 ch. PPG timer : 16 bit × 8 ch. (8 bit × 16 ch.) PWC timer : 16 bit × 1 ch. External interrupt : 24 ch. Input capture : 16 bit × 4 ch., 32 bit × 4 ch. Output compare : 16 bit × 4 ch., 32 bit × 4 ch. free-run timer : 16 bit × 2 ch., 32 bit × 1 ch. Up/down counter : 16 bit × 2 ch. (8 bit × 4 ch.)
MB91F346B		100P	100P	

Package: P-plastic

The pin of each peripheral function is using combinedly. Please confirm the combination of the peripheral function that can be used by the pin assignment.

32-bit FR Family

(Continued)

Series name	Function	Type	RAM/ROM	Pin number	Stepping motor controller macro/sub clock	Part number	
MB91360 series	DMAC (5 ch.) , RTC (1 ch.) , I ² C (1 ch.) , SIO (2 ch.) , Watch. Dog Timer (1 ch.) , CAN (3 ch., 2 ch.) , A/D converter (10 bit × 16 ch., 10 ch., 8 ch.) , UART (3 ch., 2 ch., 1 ch.) , Reload timer (16 bit × 6 ch., 3 ch.) , D/A converter (8 bit × 2 ch., no) , PPGtimer (16 bit × 8 ch., 4 ch.) , Input capture (16 bit × 4 ch., no) , Output compare (16 bit × 4 ch., 2 ch., nothing) , free-run timer (16 bit × 2 ch., no) , Sound generator (1 ch., no)	MASK	RAM: 36 KB Flash: 512 KB	120	Yes/Yes	MB91366GA	
		Flash	RAM: 16 KB Flash: 256 KB	120	No/Yes	MB91F364G	
			RAM: 20 KB Flash: 512 KB	208	Yes/No	MB91F362GB	
			RAM: 36 KB Flash: 512 KB	120	Yes/No	MB91F365GB	
					Yes/Yes	MB91F366GB	
					No/No	MB91F367GB	
			No/Yes	MB91F368GB			
		RAM: 36 KB Flash: 768 KB	120	Yes/Yes	MB91F376G		
		Evaluation device	RAM: 36 KB Flash: 512 KB			Evaluation target device MB91360 series	MB91FV360GA

(Continued)

■ MB91360 series

- For meter, mechatronics control, etc.

MB91F364G
Flash: 256 KB
RAM: 16 KB

MB91F365GB
Flash: 512 KB
RAM: 36 KB

MB91F366GB
Flash: 512 KB
RAM: 36 KB

MB91366GA
ROM: 512 KB
RAM: 36 KB

MB91F376G
Flash: 768 KB
RAM: 36 KB

MB91F369GA
Flash: 512 KB
RAM: 36 KB

MB91F362GB
Flash: 512 KB
RAM: 20 KB

MB91F367GB
Flash: 512 KB
RAM: 36 KB

MB91F368GB
Flash: 512 KB
RAM: 36 KB

- Maximum clock frequency : 64 MHz
- Operating temperature range : -40 °C to +85 °C
- Operating power supply voltage: +4.25 V to +5.25 V

Part number	Operating power supply voltage (V)	Package		Functions
		QFP (0.65 mm)	QFP (0.5 mm)	
MB91F362GB	+4.25 to +5.25	—	208P	<p>Maximum operating frequency : 64 MHz Flash memory : 512 KB RAM : 4 KB Instruction RAM : 4 KB DATA RAM : 12 KB DMA controller : 5 ch. (External 1 ch.) Stepping motor controller : 4 ch. A/D converter : 10bit × 16 ch. D/A converter : 10 bit × 2 ch. SIO : 2 ch. UART : 3 ch. I²C : 1 ch.</p> <p>External interrupt : 8 ch. Input capture : 16 bit × 4 ch. Output compare : 16 bit × 4 ch. free-run timer : 16 bit × 2 ch. Reload timer : 16 bit × 6 ch. Watch DOG Timer CAN : 3 ch. U-Timer : 3 ch. Real time clock : 1 ch. PPG : 8 ch. Sound generator: 1 ch.</p>
MB91F364G	+4.25 to +5.25	—	120P	<p>Maximum operating frequency : 64 MHz Flash memory : 256 KB RAM : 4 KB DATA RAM : 12 KB A/D converter : 10bit × 12 ch. D/A converter : 10 bit × 2 ch. SIO : 1 ch. UART : 1 ch. I²C : 1 ch.</p> <p>External interrupt : 8 ch. Input capture : 16 bit × 4 ch. Output compare : 16 bit × 4 ch. free-run timer : 16 bit × 2 ch. Reload timer : 16 bit × 3 ch. Watch DOG Timer CAN : 3 ch. U-Timer : 1 ch. Real time clock : 1 ch. PPG : 4 ch.</p>
MB91F365GB	+4.25 to +5.25	—	120P	<p>Maximum operating frequency : 64 MHz MASK ROM: 512 KB (MB91366GA) Flash memory 512 KB (MB91F365GB/F366GB) 768 KB (MB91F376G) RAM : 16 KB Instruction RAM : 4 KB DATA RAM : 16 KB DMA controller : 5 ch. Stepping motor controller : 4 ch. A/D converter : 10bit × 8 ch. D/A converter : 10 bit × 2 ch. (MB91F365GB)</p> <p>SIO : 2 ch. UART : 2 ch. I²C : 1 ch. External interrupt : 8 ch. Input capture : 16 bit × 4 ch. Output compare : 16 bit × 2 ch. free-run timer : 16 bit × 2 ch. Reload timer : 16 bit × 6 ch. Watch DOG Timer CAN : 2 ch. Real time clock : 1 ch. PPG : 16 bit × 8 ch. Sound generator: 1 ch.</p>
MB91366GA		—	120P	
MB91F366GB		—	120P	
MB91F376G		—	120P	
MB91F367GB	+4.25 to +5.25	—	120P	<p>Maximum operating frequency : 64 MHz Flash memory : 512 KB RAM : 16 KB Instruction RAM : 4 KB DATA RAM : 16 KB DMA controller : 5 ch. A/D converter : 10bit × 8 ch. SIO : 2 ch. UART : 1 ch. I²C : 1 ch.</p> <p>External interrupt : 8 ch. Input capture : 16 bit × 4 ch. Output compare : 16 bit × 2 ch. free-run timer : 16 bit × 2 ch. Reload timer : 16 bit × 3 ch. Watch DOG Timer CAN : 2 ch. Real time clock : 1 ch. PPG : 16 bit × 4 ch.</p>
MB91F368GB		—	120P	
MB91F369GA	+4.25 to +5.25	160P	—	<p>Maximum operating frequency : 64 MHz Flash memory : 512 KB RAM : 16 KB Instruction RAM : 4 KB DATA RAM : 16 KB DMA controller : 5 ch. (External 1 ch.) CAN : 2 ch. A/D converter : 10bit × 10 ch. SIO : 2 ch.</p> <p>UART/U-Timer : 1 ch. I²C : 1 ch. External interrupt : 8 ch. Reload timer : 16 bit × 6 ch. Watch DOG Timer Real time clock : 1 ch. Sound generator: 1 ch. PPG : 4 ch.</p>

Package: P-plastic

32-bit FR Family

(Continued)

Series name	Function	Type	RAM/ROM	Pin number	Part number
MB91460 series	DMAC (5 ch.) , CAN controller (2 ch.) , UART for LIN (7 ch.) , I ² C interface (3 ch.) , A/D converter (10 bit × 13 ch.) , Reload timer (16 bit × 5 ch.) , Input capture (16 bit × 4 ch.) , Output compare (16 bit × 4 ch.) , free-run timer (16 bit × 4 ch.) , PPG timer (16 bit × 8 ch.) , Timebase timer (WDT:26 bit × 1 ch.) , Real time clock External interrupt input (16 ch.) , DSU4	ROM less	RAM: 64 KB I-cache: 4 KB	176	MB91461
		Evaluation device	RAM: 128 KB	Evaluation target device	
(Continued)	DMAC (5 ch.) , CAN controller (2 ch.) , UART for LIN (7 ch.) , I ² C interface (3 ch.) , A/D converter (10 bit × 16 ch.) , Reload timer (16 bit × 5 ch.) , Input capture (16 bit × 4 ch.) , Output compare (16 bit × 4 ch.) , free-run timer (16 bit × 4 ch.) , PPG timer (16 bit × 8 ch.) , Timebase timer (WDT:26 bit × 1 ch.) , Real time clock External interrupt input (16 ch.) , SDRAM I/F	Flash	RAM: 64 KB ROM: 1088 KB cache: 4 KB	176	MB91F467R
		Evaluation device	RAM: 128 KB	Evaluation target device	

(Continued)

(Continued)

■ MB91460 series

- Car audio and car navigation, etc.

MB91461
RAM: 64 KB
I-cache: 4 KB

MB91F467R
Flash: 1088 KB
RAM: 64 KB
Cache: 4 KB

- Maximum clock frequency : 80 MHz
- Operating temperature range : -40 °C to +85 °C
- Operating power supply voltage: +3.0 V to +3.6 V

Part number	Operating power supply voltage (V)	Package	Functions
		LQFP	
MB91461	+3.0 to +3.6	176P	Maximum operating frequency: 80 MHz Flash memory: 1088 KB (MB91F467R) RAM: 64 KB Instruction cache: 4 KB (MB91461) Cache: 8 KB (MB91F467R) DMAC: 5 ch. CAN interface (32 message buffer) : 2 ch. (MB91461) CAN interface (32 and 64 message buffer) : 2 ch. (MB91F467R) UART for LIN: 7 ch. I ² C bus interface: 3 ch. A/D converter: 10bit × 13 ch. (MB91461) 10bit × 16 ch. (MB91F467R) Rerod timer: 16 bit × 5 ch. Input capturer: 16 bit × 4 ch. Output compare: 16 bit × 4 ch. free-run timer: 16 bit × 4 ch. PPG timer: 16 bit × 8 ch. Timebase timer (WDT) : 26 bit × 1 ch. Realtime clock External interrupt input: 16 ch. Low-power consumption: sleep, stop, shut-down mode 5 V can be set to a part of I/O (When 5 V is supplied to the I/O power supply) . SDRAM I/F (MB91F467R) DSU4 (debug support unit, MB91461 only)
MB91F467R			

Package: P-plastic

32-bit FR Family

Series name	Function	Type	RAM/ROM	Pin number	Part number
MB91460 series	DMAC (5 ch.) , CAN controller (1 ch.) , UART for LIN (5 ch.) , I ² C interface (1 ch.) , A/D converter (10 bit × 21 ch.) , Reload timer (16 bit × 8 ch.) , Input capture (16 bit × 8 ch.) , Output compare (16 bit × 6 ch.) , free-run timer (16 bit × 8 ch.) , PPG timer (16 bit × 10 ch.) , Timebase timer (WDT:26 bit × 1 ch.) , Real time clock External interrupt input (10 ch.)	Flash	RAM: 16 KB Flash: 416 KB	100	MB91F464AB
		Evaluation device	RAM: 128 KB	Evaluation target device	
(Continued)	DMAC (5 ch.) , CAN controller (1 ch.) , UART for LIN (5 ch.) , I ² C interface (1 ch.) , A/D converter (10 bit × 26 ch.) , Reload timer (16 bit × 8 ch.) , Input capture (16 bit × 8 ch.) , Output compare (16 bit × 8 ch.) , free-run timer (16 bit × 8 ch.) , PPG timer (16 bit × 12 ch.) , Timebase timer (WDT:26 bit × 1 ch.) , Real time clock External interrupt input (10 ch.)	Flash	RAM: 16 KB ROM: 544 KB	120	MB91F465KB
		Evaluation device	RAM: 128 KB	Evaluation target device	

32-bit FR Family

- For automotive products, etc.

MB91F464AB
Flash: 416 MB
RAM: 16 KB

MB91F465KB
Flash: 544 MB
RAM: 16 KB
Cache: 4 KB

- Maximum clock frequency : 80 MHz
- Operating temperature range : -40 °C to +85 °C
- Operating power supply voltage: +3.0 V to +5.5 V

Part number	Operating power supply voltage (V)	Package	Functions
		LQFP	
MB91F464AB	+3.0 to +5.5	100P	Maximum operating frequency: 80 MHz Flash memory: 416 KB (MB91F464AB) 544 KB (MB91F465KB) RAM: 16 KB Cache: 4 KB (MB91F465KB) DMAC: 5 ch. CAN interface (32 message buffer) : 1 ch. UART for LIN: 5 ch. I ² C bus interface: 1 ch. A/D converter: 10bit × 21 ch. (MB91F464AB) 10bit × 26 ch. (MB91F465KB)
MB91F465KB		120P	Rerod timer: 16 bit × 8 ch. Output compare: 16 bit × 6 ch. (MB91F464AB) 16 bit × 8 ch. (MB91F465KB) Input capturer: 16 bit × 8 ch. free-run timer: 16 bit × 4 ch. PPG timer: 16 bit × 10 ch. (MB91F464AB) 16 bit × 12 ch. (MB91F465KB) Timebase timer (WDT) : 26 bit × 1 ch. Realtime clock External interrupt input: 10 ch. Low-power consumption: sleep, stop

Package: P-plastic

32-bit FR Family

Series name	Function	Type	RAM/ROM	Pin number	Part number
MB91460 series	DMAC (5 ch.) , Real time clock, Free-run timer (16-bit × 8 ch.) , Input capture (16 bit × 8 ch.) , Output compare (16 bit × 8 ch.) , Reload timer (16 bit × 8 ch.) , PPG timer (16 bit × 16 ch.) , Sound generator, Up/down counter (16 bit × 2 ch.) , CAN interface (6 ch. × 32msg buffer) , LIN-UART (7 ch.) , I ² C interface (2 ch.) , External interrupt input (16 ch.) , A/D converter (10 bit × 32 ch.) , Low voltage detection, SMC (6 ch.)	Flash	RAM : 40 KB Flash : 1088 KB Cache : 8 KB	144	MB91F467BA
		Evaluation device	RAM : 128 KB	Evaluation target device MB91460 series MB91V460	
(Continued)	DMAC (5 ch.) , Realtime clock, Free-run timer (16 bit × 8 ch.) , Input capture (16 bit × 8 ch.) , Output compare (16 bit × 8 ch.) , Reload timer (16 bit × 8 ch.) , PPG timer (16 bit × 16 ch.) , Sound generator, Up/down counter (16 bit × 2 ch.) , CAN interface (3 ch × 32msg buffer) , LIN-UART (7 ch.) , I ² C interface (2 ch.) , External interrupt input (16 ch.) , A/D converter (10 bit × 32 ch.) , Low voltage detection, SMC (60ch)	Flash	RAM : 40 KB Flash : 544 KB Cache : 8 KB	144	MB91F465BA
		Evaluation device	RAM : 128 KB	Evaluation target device MB91460 series MB91V460	

32-bit FR Family

- For automotive product, car audio, etc.

MB91F465BA
Flash : 544 KB
RAM : 40 KB
Cache : 8 KB

MB91F467BA
Flash : 1088 KB
RAM : 40 KB
Cache : 8 KB

- Maximum clock frequency : 80 MHz
- Operating temperature range : -40 °C to +105 °C
- Operating power supply voltage: +3.0 V to +5.5 V

Part number	Operating power supply voltage (V)	Package	Functions
		LQFP	
MB91F465BA	+3.0 to +5.5	144P	Maximum operating frequency : 80 MHz Flash memory : 544 KB (MB91F465BA) 1088 KB (MB91F467BA) RAM : 40 KB Cache : 8 KB DMAC : 5 ch. Realtime clock Free-run timer : 16 bit × 8 ch. Input capture : 16 bit × 8 ch. Output compare : 16 bit × 8 ch. Reload timer : 16 bit × 8 ch. PPG timer : 16 bit × 16 ch. Sound generator Up/down counter : 16 bit × 2 ch. CAN interface (32 message buffer) : 3 ch. (MB91F465BA) 6 ch. (MB91F467BA) LIN-UART : 7 ch. I ² C interface: 2 ch. External interrupt input : 16 ch. A/D converter : 10bit × 32 ch. Low voltage detection SMC: 6 ch.
MB91F467BA			

Package: P-plastic

32-bit FR Family

Series name	Function	Type	RAM/ROM	Pin number	Part number
MB91460 series	DMAC (5 ch.) , Realtime clock, Free-run timer (16 bit × 8 ch.) , Input capture (16 bit × 8 ch.) , Output compare (16 bit × 4 ch.) , Reload timer (16 bit × 8 ch.) , PPG timer (16 bit × 12 ch.) , Sound generator, Up/down counter (16 bit × 2 ch.) , CAN interface (3 ch × 32msg buffer) , LIN-UART (5 ch.) , I ² C interface (3 ch.) , External interrupt input (14 ch.) , A/D converter (10 bit × 24 ch.) , Low voltage detection, SMC (6 ch.)	Flash	RAM : 64 KB Flash : 1088 KB Cache : 8 KB	208	MB91F467DB
		Evaluation device	RAM : 128 KB		Evaluation target device MB91460 series MB91V460
	FlexRay (2 ch.) , DMAC (5 ch.) , CAN controller (2 ch.) , LIN-UART (3 ch.) , I ² C interface (1 ch.) , A/D converter (10 bit × 17 ch.) , Reload timer (16 bit × 8 ch.) , Input capture (16 bit × 8 ch.) , Output compare (16 bit × 6 ch.) , Free-run timer (16 bit × 8 ch.) , PPG timer (16 bit × 12 ch.) , Timebase timer (WDT: 26 bit × 1 ch.) , Realtime clock, External interrupt input (11 ch.)	Flash	RAM :32 KB Flash : 544 KB	100	MB91F465XA
		Evaluation device	RAM : 128 KB		Evaluation target device MB91460 series MB91V460

(Continued)

32-bit FR Family

- For dashboard, etc

MB91F467DB
Flash : 1088 KB
RAM : 64 KB
Cache : 8 KB

- Maximum clock frequency : 96 MHz
- Operating temperature range : -40 °C to +105 °C
- Operating power supply voltage: +3.0 V to +5.5 V

Part number	Operating power supply voltage (V)	Package	Functions
		QFP	
MB91F467DB	+3.0 to +5.5	208P	Maximum operating frequency : 96 MHz Flash memory : 1088 KB RAM : 64 KB Cache : 8 KB DMAC : 5 ch. Realtime clock Free-run timer : 16 bit × 8 ch. Input capture : 16 bit × 8 ch. Output compare : 16 bit × 4 ch. Reload timer : 16 bit × 8 ch. PPG timer : 16 bit × 12 ch. Sound generator Up/down counter : 16 bit × 2 ch. CAN interface (32 message buffer) : 3 ch. LIN-UART : 5 ch. I ² C interface: 3 ch. External interrupt input : 14 ch. A/D converter : 10bit × 24 ch. Low voltage detection SMC: 6 ch. Timebase timer (WDT) : 26 bit × 1 ch.

Package: P-plastic

- FlexRay

MB91F465XA
Flash : 544 KB
RAM : 32 KB
Cache : 8 KB

- Maximum clock frequency : 100 MHz
- Operating temperature range : -40 °C to +105 °C
- Operating power supply voltage: +3.0 V to +5.5 V

Part number	Operating power supply voltage (V)	Package	Functions
		LQFP	
MB91F465XA	+3.0 to +5.5	100P	Maximum operating frequency : 100 MHz Flash memory : 544 KB RAM : 32 KB Cache : 8 KB DMAC : 5 ch. FlexRay : 2 ch. CAN interface (32 message buffer) : 2 ch. LIN-UART : 3 ch. I ² C interface: 1 ch. A/D converter : 10bit × 17 ch. Reload timer : 16 bit × 8 ch. Input capture : 16 bit × 8 ch. Output compare : 16 bit × 6 ch. Free-run timer : 16 bit × 8 ch. PPG timer : 16 bit × 12 ch. Timebase timer (WDT) : 26 bit × 1 ch. Realtime clock External interrupt input : 11 ch. Low-power consumption modes: sleep, stop

Package: P-plastic

32-bit FR Family

(Continued)

Series name	Function	Type	RAM/ROM	Pin number	Part number
MB91470 series	DMAC (5 ch.) , 8/10-bit A/D converter (12 ch. × 1 unit) , 12-bit A/D converter (4 ch. × 2 unit) , Multi function serial interface : 6 ch. , Reload timer (16 bit × 2 ch.) , PPG timer (16 bit × 4 ch.) , Base timer (16 bit × 4 ch.) , External interrupt input (10 ch. + NMI) , Input capture (16 bit × 4 ch.) , Output compare (16 bit × 6 ch.) , free-run timer (16 bit × 3 ch.) , Wave generator, MAC circuit	Flash	RAM: 16 KB Flash: 256 KB	144	MB91F475
		Flash	RAM: 24 KB Flash: 384 KB	144	MB91F478
		Flash	RAM: 32 KB Flash: 512 KB	144	MB91F479
		Evaluation device	RAM: 40 KB ROM: 512 KB	MB91470 series	MB91FV470
MB91480 series	DMAC (5 ch.) , 8/10-bit A/D converter (10 ch. × 1 unit, 4 ch. × 2 unit) , Multi function serial interface : 3 ch. , Reload timer (16 bit × 2 ch.) , PPG timer (16 bit × 8 ch.) , Base timer (16 bit × 4 ch.) , External interrupt input (10 ch. + NMI) , Input capture (16 bit × 8 ch.) , Output compare (16 bit × 12 ch.) , free-run timer (16 bit × 6 ch.) , Wave generator, MAC circuit	Flash	RAM: 16 KB Flash: 256 KB	100	MB91F482
		Flash	RAM: 32 KB Flash: 512 KB	100	MB91F487
		Mask	RAM: 16 KB ROM: 256 KB	100	MB91482 *
		Evaluation device	RAM: 40 KB ROM: 512 KB	MB91480 series	MB91FV470

*: Under development

(Continued)

■ MB91470 series

- Car audio and car navigation, etc.

MB91F475 Flash: 256 MB RAM: 16 KB	MB91F478 Flash: 384 MB RAM: 24 KB	MB91F479 Flash: 512 KB RAM: 32 KB	<ul style="list-style-type: none"> • Maximum clock frequency : 80 MHz • Operating temperature range : -40 °C to +85 °C • Operating power supply voltage: +4.0 V to +5.5 V
---	---	---	--

Part number	Operating power supply voltage (V)	Package	Functions
		LQFP (0.4 mm)	
MB91F475	+4.0 to +5.5	144P	Maximum operating frequency: 80 MHz Flash memory: 512 KB RAM: 32 KB DMAC: 5 ch. 8/10-bit A/D converter: 12 ch. × 1 unit 12-bit A/D converter: 4 ch. × 2 unit Multi function serial interface (UART/SIO/I ² C): 6 ch. Reroad timer: 16 bit × 2 ch. PPG timer: 16 bit × 4 ch. Base timer: 16 bit × 4 ch. External interrupt input: 10 ch. Input capturer: 16 bit × 4 ch. Output compare: 16 bit × 6 ch. free-run timer: 16 bit × 4 ch. Wave generator (for motor drive) MAC (Multiplication and Addition Calculator) circuit
MB91F478		144P	
MB91F479		144P	

Package: P-plastic

■ MB91480 series

- Car audio and car navigation, etc.

MB91482 ROM: 256 MB RAM: 16 KB Under development	MB91F482 Flash: 256 MB RAM: 16 KB	MB91F487 Flash: 512 KB RAM: 32 KB	<ul style="list-style-type: none"> • Maximum clock frequency : 80 MHz • Operating temperature range : -40 °C to +85 °C • Operating power supply voltage: +4.0 V to +5.5 V
---	---	---	--

Part number	Operating power supply voltage (V)	Package	Functions
		LQFP (0.5 mm)	
◎MB91482	+4.0 to +5.5	100P	Maximum operating frequency: 80 MHz Flash memory: 512 KB RAM: 32 KB DMAC: 5 ch. 8/10-bit A/D converter: 10 ch. × 1 unit, 4 ch. × 2 unit Multi function serial interface (UART/SIO/I ² C): 3 ch. Reroad timer: 16 bit × 2 ch. PPG timer: 16 bit × 8 ch. Base timer: 16 bit × 4 ch. External interrupt input: 10 ch. Input capturer: 16 bit × 8 ch. Output compare: 16 bit × 12 ch. free-run timer: 16 bit × 6 ch. Wave generator (for motor drive) MAC (Multiplication and Addition Calculator) circuit
MB91F482		100P	
MB91F487		100P	

Package: P-plastic

◎: Under development

32-bit FR Family

(Continued)

Series name	Function	Type	RAM/ROM	Pin number	Part number
MB91605 series	DMAC (4 ch.) , A/D converter (10-bit × 12 ch.) , Multi function serial interface : 12 ch., Reload timer (16-bit × 3 ch.) , Base timer (16-bit × 12 ch.) , HDMI-CEC (1 ch.) , External interrupt input (24 ch. + NMI) ,	ROM less	RAM: 128 KB Instruction cash: 8 KB Data cash: 8 KB	176	MB91605

(Continued)

■ MB91605 series **FR80E**

- For TV/PDP control, home electric equipment, etc.

MB91605
RAM: 128 KB
Instruction cashe : 8 KB
Data cashe : 8 KB

- Maximum clock frequency : 80 MHz
- Operating temperature range : -10 °C to +70 °C
- Operating power supply voltage: +3.0 V to +3.6 V
+1.65 V to +1.95 V

Part number	Operating power supply voltage (V)	Package	Functions
		LQFP (0.5 mm)	
MB91605	+3.0 to +3.6 +1.65 to +1.95	176P	Maximum operating frequency: 80 MHz RAM : 128 KB Instruction cashe : 8 KB Data cashe : 8 KB DMA controller : 8 ch. A/D converter: 10-bit × 12 ch. Multi function serial interface (UART/SIO/I ² C): 12 ch. Reroad timer: 16 bit × 3 ch. Base timer (reroad timer/PWM/PWC/PPG, for 32-bit mode): 16 bit × 12 ch. HDMI-CEC : 1 ch. External interrupt input : 24 ch. SDRAM I/F Watch DOG Timer

Package: P-plastic

32-bit FR Family

(Continued)

Series name	Function	Type	RAM/ROM	Pin number	Part number
MB91635 series	DMAC (8 ch.) , 10-bit A/D converter (31 ch. × 2 unit) , 8-bit D/A converter (3 ch.) , Multi function serial interface : 12 ch. , Reload timer (16 bit × 3 ch.) , U/D counter (16 bit × 4 ch.) , Base timer (16 bit × 16 ch.) , External interrupt input (32 ch. + NMI) , Input capture (32 bit × 8 ch.) , Output compare (32 bit × 8 ch.) , free-run timer (32 bit × 2 ch.) , Watch timer, External bus mode	Flash	RAM: 48 KB Flash: 512 KB	144	MB91F637
			RAM: 64 KB Flash: 1 MB	144	MB91F639
		Evaluation device	RAM: 128 KB	Evaluation target device	
MB91645 series	DMAC (8 ch.) , 10-bit A/D converter (31 ch. × 2 unit) , 8-bit D/A converter (3 ch.) , Multi function serial interface : 12 ch. , Reload timer (16 bit × 3 ch.) , U/D counter (16 bit × 4 ch.) , Base timer (16 bit × 16 ch.) , External interrupt input (32 ch. + NMI) , Input capture (32 bit × 8 ch.) , Output compare (32 bit × 8 ch.) , free-run timer (32 bit × 2 ch.) , Watch timer, External bus mode	Flash	RAM: 48 KB Flash: 512 KB	176	MB91F647
		Evaluation device	RAM: 128 KB	Evaluation target device	

(Continued)

■ MB91635 series **FR80S**

- For home electric equipment, camera, AV products, etc.

MB91F637
Flash: 512 MB
RAM: 48 KB

MB91F639
Flash: 1 MB
RAM: 64 KB

- Maximum clock frequency : 60 MHz
- Operating temperature range : -40 °C to +85 °C
- Operating power supply voltage: +2.7 V to +3.6 V

Part number	Operating power supply voltage (V)	Package	Functions
		LQFP (0.5 mm)	
MB91F637	+2.7 to +3.6	144P	Maximum operating frequency: 60 MHz Flash memory: 512 KB (MB91F637) 1 MB (MB91F639) RAM: 48 KB (MB91F637) 64 KB (MB91F639) DMAC: 8 ch. 10-bit A/D converter: 31 ch. × 2 unit 8-bit D/A converter: 3 ch. Multi function serial interface (UART/SIO/I ² C): 12 ch. Reroad timer: 16 bit × 3 ch. U/D counter: 16 bit × 4 ch. Base timer (reroad timer/PWM/PWC/PPG, for 32-bit mode): 16 bit × 16 ch. External interrupt input: 32 ch. Input capturer: 32 bit × 8 ch. Output compare: 32 bit × 8 ch. Free-run timer: 32 bit × 2 ch. Watch timer External bus mode
MB91F639		144P	

Package: P-plastic

■ MB91645 series **FR80S**

- For home electric equipment, camera, AV products, etc.

MB91F647
Flash: 512 MB
RAM: 48 KB

- Maximum clock frequency : 60 MHz
- Operating temperature range : -40 °C to +85 °C
- Operating power supply voltage: I/O: +2.7 to +3.6
Internal logic: +1.65 to +1.95

Part number	Operating power supply voltage (V)	Package	Functions
		LQFP (0.5 mm)	
MB91F647	I/O: +2.7 to +3.6 Internal logic: +1.65 to +1.95	176P	Maximum operating frequency: 60 MHz Flash memory: 512 KB RAM: 48 KB DMAC: 8 ch. 10-bit A/D converter: 32 ch. × 2 unit 8-bit D/A converter: 3 ch. Multi function serial interface (UART/SIO/I ² C): 12 ch. Reroad timer: 16 bit × 3 ch. U/D counter: 16 bit × 4 ch. Base timer (reroad timer/PWM/PWC/PPG, for 32-bit mode): 16 bit × 16 ch. External interrupt input: 32 ch. Input capturer: 32 bit × 8 ch. Output compare: 32 bit × 8 ch. Free-run timer: 32 bit × 2 ch. Watch timer External bus mode

Package: P-plastic

32-bit FR Family

(Continued)

Series name	Function	Type	RAM/ROM	Pin number	Part number
MB91660 series	DMAC (8 ch.) , 10-bit A/D converter (24 ch. × 2 unit) , 8-bit D/A converter (3 ch.) , Multi function serial interface : 12 ch., Reload timer (16 bit × 3 ch.) , U/D counter (16 bit × 4 ch.) , Base timer (16 bit × 16 ch.) , External interrupt input (32 ch.) , Input capture (32 bit × 8 ch.) , Output compare (32 bit × 8 ch.) , free-run timer (32 bit × 2 ch.) , USB Function (Full-speed) , USB Mini-Host (Full-speed) , Slave interface Watch counter	Mask	RAM: 32 KB ROM: 384 KB	120	MB91661 *
		Flash	RAM: 48 KB Flash: 512 KB	120	MB91F662

*: Under development

MB91660 series **FR80S**

- For TV controll, home electric equipment, etc.

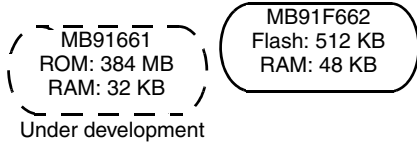

- Maximum clock frequency : 33 MHz
- Operating temperature range : -40 °C to +85 °C
- Operating power supply voltage: +3.0 V to +3.6 V

Part number	Operating power supply voltage (V)	Package	Functions
		LQFP (0.5 mm)	
©MB91661	+3.0 to +3.6	120P	Maximum operating frequency: 33 MHz ROM : 384 KB (MB91F661) Flash memory: 512 KB (MB91F662) RAM: 32 KB (MB91661) 48 KB (MB91F662) DMA controller : 8 ch. 10-bit A/D converter: 24 ch. × 2 unit 8-bit D/A converter: 3 ch. Multi function serial interface (UART/SIO/I ² C): 12 ch. Reroad timer: 16 bit × 3 ch. U/D counter: 16 bit × 4 ch. Base timer (reroad timer/PWM/PWC/PPG, for 32-bit mode): 16 bit × 16 ch. External interrupt input: 32 ch. Input capturer: 32 bit × 8 ch. Output compare: 32 bit × 8 ch. Free-run timer: 32 bit × 2 ch. USB Function (Full-speed) USB Mini-Host (Full-speed) Slave interface Watch timer Watch DOG Timer
MB91F662		120P	

Package: P-plastic

©: Under development

■ FR Family Support Tools

Features of Support Environments

(1) Comprehensive Development Environments (SOFTUNE Workbench) around C language

- Achieving effective development environments
- Enhancing the concerted use of independent development tools, allowing all tools to behave as if they were a single tool
- Support in collaboration with source generation management tools
- Made available both Japanese and English version simultaneously

(2) Supporting the tools for quality, performance, analysis of source programs

- SOFTUNE C/C++ Checker
Investigating the description form of a source to display the information to enhance portability/maintainability
- SOFTUNE C/C++ Analyzer
Analyzing the source description; displaying the overall hierarchical organization; effective for maintainability/portability

(3) Providing Embedded Real-time OS

- In conformance with μ ITRON Specifications known as the Japanese industry standard
 - μ ITRON3.0 Specifications SOFTUNE REALOS/FR
 - μ ITRON4.0 Specifications SOFTUNE REALOS/FR Spec.4
- In conformance with μ T-Kernel Specifications known as the Embedded Real-time OS for the next generation
 - μ T-Kernel Specifications SOFTUNE μ T-REALOS/FR
- The flexible system configuration matched to customer's application
SOFTUNE REALOS Configurator
- The development of customers of debugging and the tuning work, etc. is strongly backed up
SOFTUNE REALOS Analyzer

(4) The application development for the vehicle equipment control OS OSEK is supported

- Analyzing the transition of task states to graphically display the results
SOFTUNE OSEK Analyzer

Development Procedure (When Fujitsu Microelectronics product is used.)

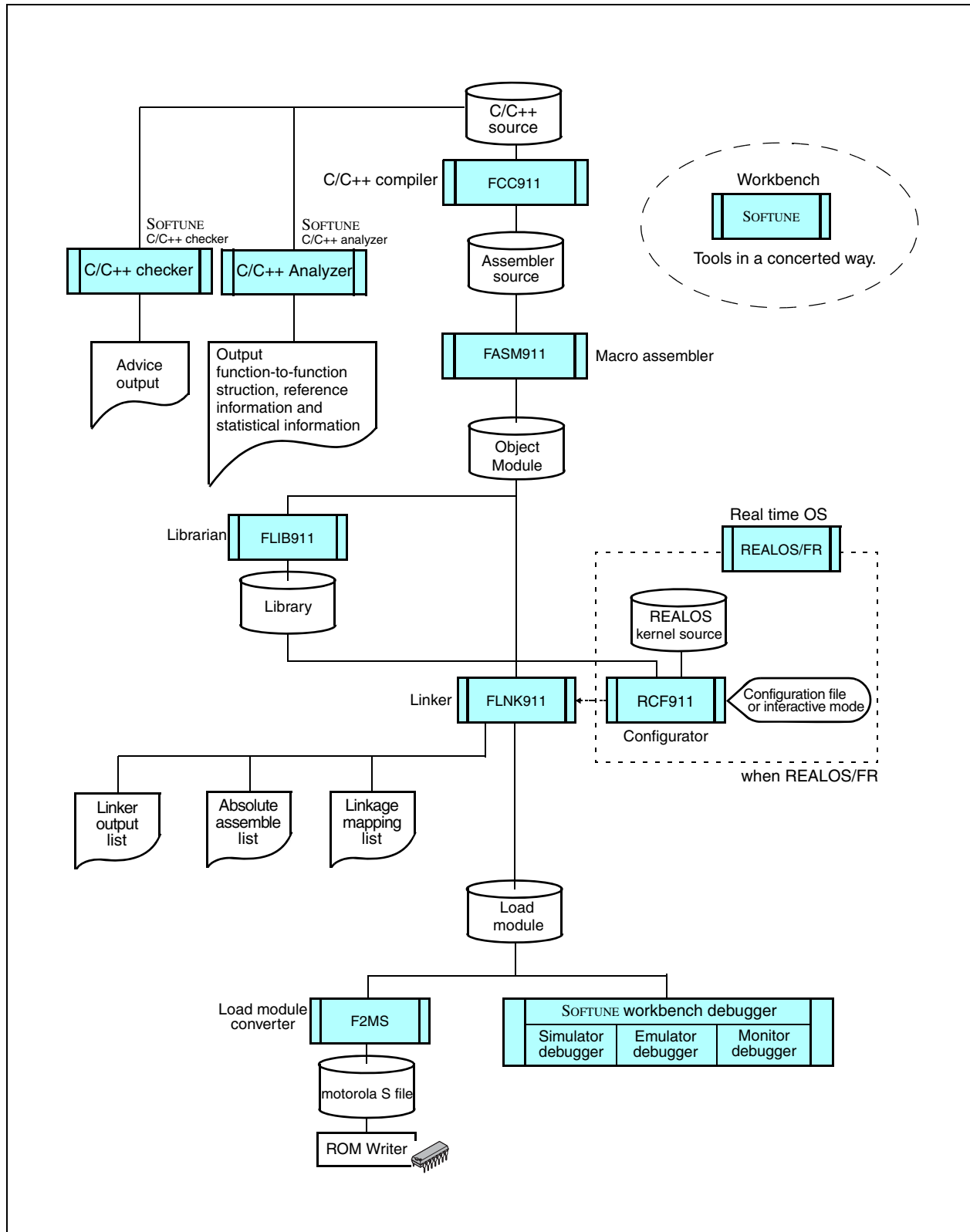

FR Family Support tools

SOFTUNE V6 Support Software Product List (For FR Family)

Software	Operating Environment	Product number (Maintenance number)	Remarks	
SOFTUNE V6 Professional Pack <Components> - Workbench - C/C++ compiler - Assembler Pack - C/C++ analyzer - C/C++ checker		SP365030118QAC (SP365030118MAC)	1 license	
		SP365030118QBC (SP365030118MBC)	3 licenses	
		SP365030118QCC (SP365030118MCC)	5 licenses	
		SP365030118QDC (SP365030118MDC)	10 licenses	
SOFTUNE V6 REALOS/FR Embedded License <Components> - Kernel - REALOS Configurator - REALOS Analyzer	- Personal computers FMV and similar IBM compatibles - Operating OS WindowsXP Windows2000 - In Circuit Emulator MB2197 series MB2198 series	SP365000218RCC (SP365000218MAC)	μITRON 3.0 Specifications License free Kernel (source code provided)	
SOFTUNE V6 REALOS/FR Evaluation License <Components> - Kernel - REALOS Configurator - REALOS Analyzer		SP365000218EVC (—)	μITRON 3.0 Specifications For evaluation Kernel (no source code)	
SOFTUNE V6 REALOS/FR Spec.4 Embedded License <Components> - Kernel Source Code - REALOS Configurator - REALOS Analyzer		SP365001518RCC (SP365001518MAC)	μITRON 4.0 Specifications License free Kernel (source code provided)	
SOFTUNE V6 REALOS/FR Spec.4 Evaluation License <Components> - Kernel - REALOS Configurator - REALOS Analyzer		SP365001518EVC (—)	μITRON 4.0 Specifications For evaluation Kernel (no source code)	
SOFTUNE V6 μT-REALOS/FR Embedded License <Components> - Kernel - μT-REALOS Configurator - REALOS Analyzer		SP3650P1218RCC (SP3650P1218MAC)	μT-Kernel Specifications License free Kernel (no source code)	
SOFTUNE V6 μT-REALOS/FR Evaluation License <Components> - Kernel - μT-REALOS Configurator - REALOS Analyzer		SP3650P1218EVC (—)	μT-Kernel Specifications For evaluation Kernel (no source code)	
SOFTUNE V6 OSEK Analyzer		- Personal computers FMV and similar IBM compatibles - Operating OS WindowsXP Windows2000	SP365031918QAC (—)	Analysis tool for OSEK made by Vector Japan Co., Ltd. or Elektrobot Corporation

- The part number is an ordered number of the newest version.
- Please contact us if purchasing the previous version as a different part is used.
- An electronic manual (PDF format) is provided with each product (Japanese and English). Printed manuals are sold separately.
- Operating OS corresponds to Japanese and English.

SOFTUNE

1. The SOFTUNE Integrated Development Environment

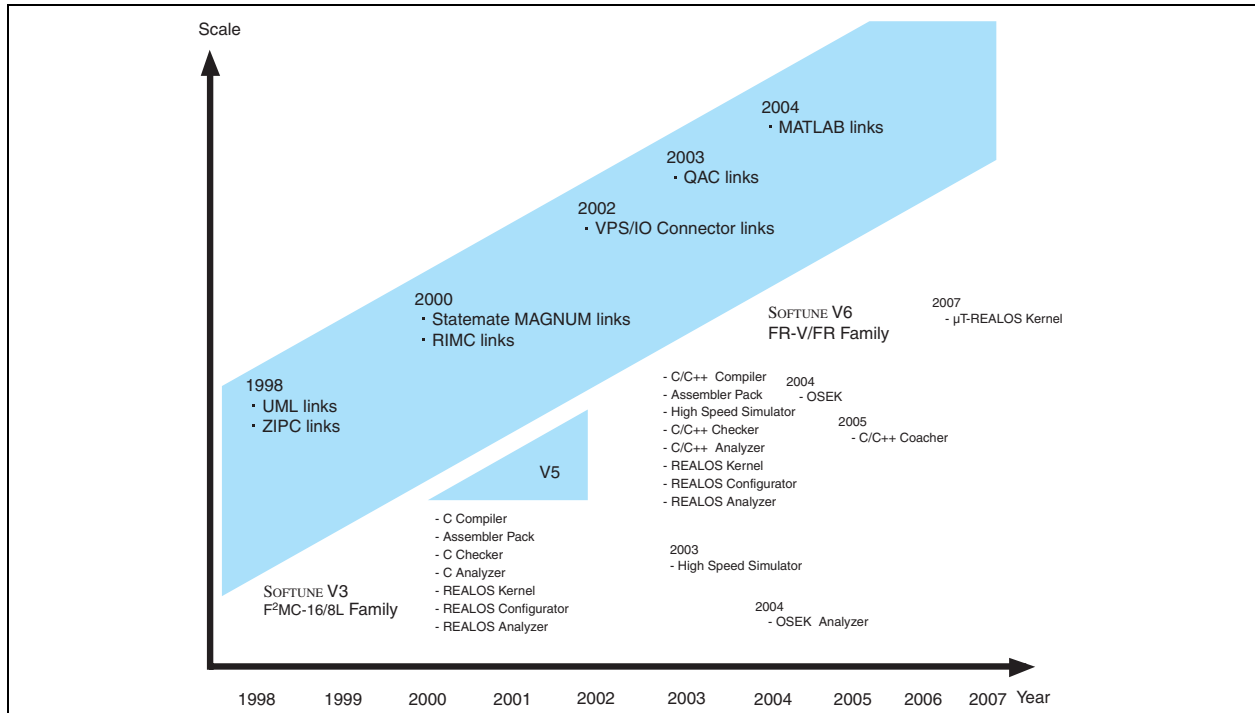

2. SOFTUNE Structure and Features

Integrated manager and debugger modules

Errors can be corrected on the fly, as they are discovered, and the resulting code can be debugged on the spot.

A variety of tools to support C/C++-language coding

"C/C++ Checker" confirms code operation and "C/C++ Analyzer" analyzes the code's structure.

Includes such tools as Configurator and Analyzer to facilitate the use of REALOS, which conforms to the μITRON specifications.

(1) Removing the Annoying Settings which are Part of Program Development

Developing programs for different systems requires the programmer to edit source code, perform actual builds and confirm program operation (debug). Finally, the programmer returns to the editing process to incorporate necessary changes, as indicated by the debugging results.

SOFTUNE is an integrated developing environment which is designed to perform such repetitive processes smoothly and efficiently. It is the next generation of SOFTUNE, which has evolved to meet various needs of our customers.

(2) Program Flow

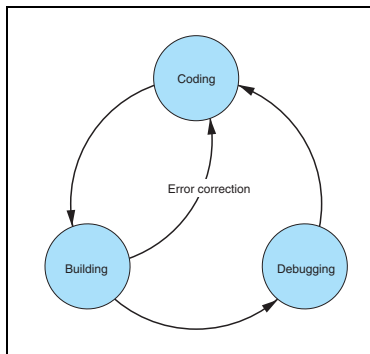

(3) Structure of SOFTUNE

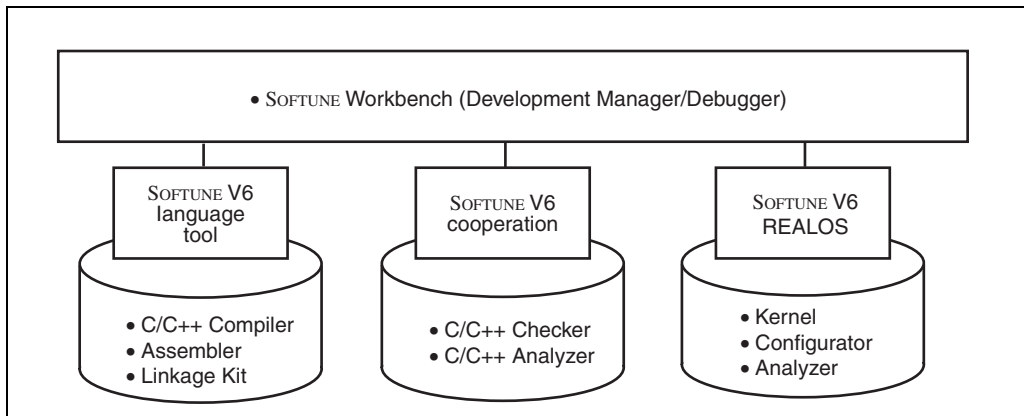

(4) Environment with SOFTUNE

The Efficient and Easy-to-Use Integrated Developing Environment

Program development requires repeated editing, make/build, and debugging operations. Performing these functions smoothly and effectively contributes to improved efficiency.

The SOFTUNE integrated developing system is designed to meet program developers' numerous demands, while ensuring ease of use.

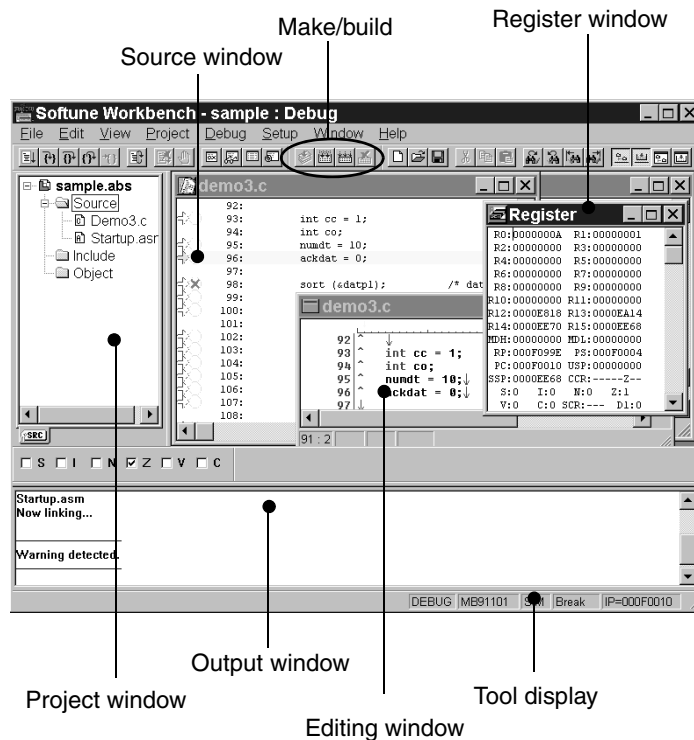

3. Manager Functions

Software programming proceeds according to the “project file,” which contains all the information needed for program development.

Workspace can manage two or more projects.

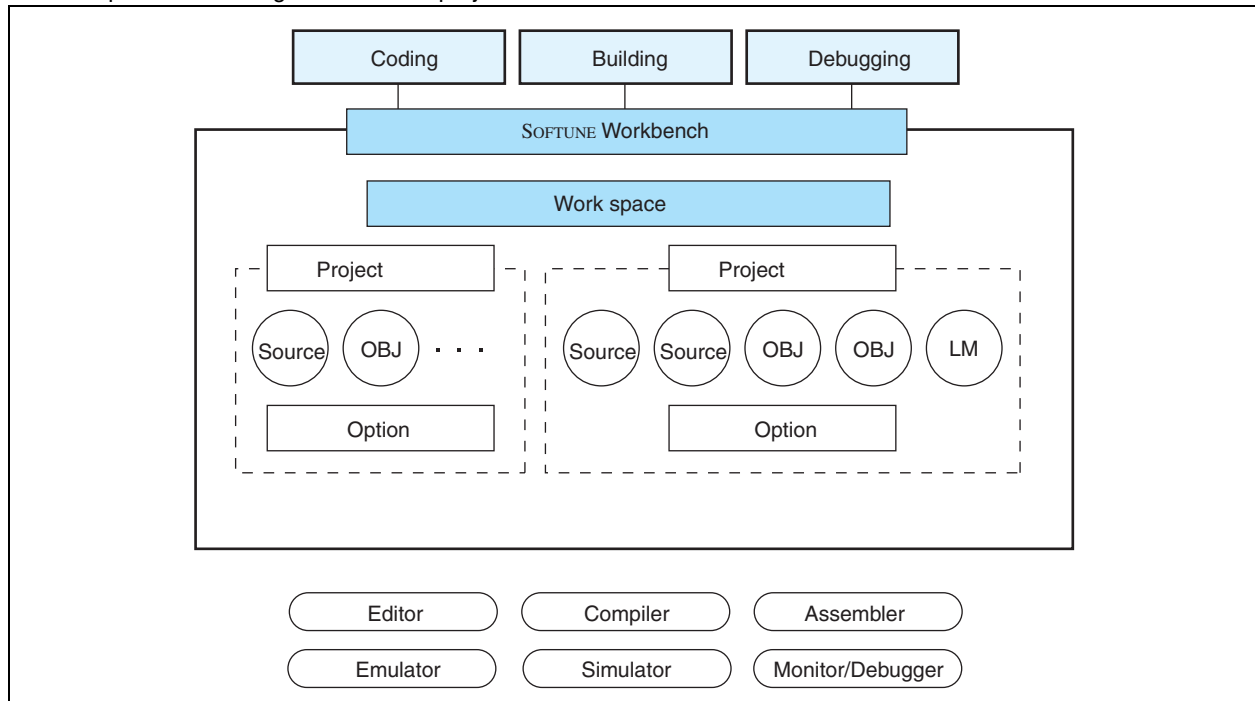

FR Family Support tools

(1) Effective Project Usage

Whether working alone on several projects simultaneously or developing a project as a group, project files can be used to create a simple developing environment.

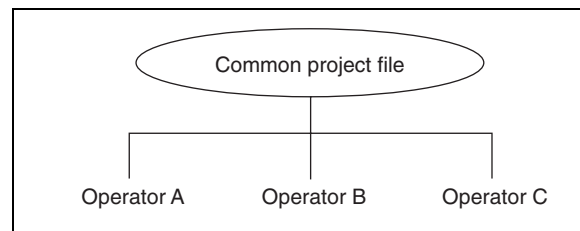

(2) Extremely Easy to Use

- Built-in Editor
The built-in editor comes complete with many useful functions, such as visual keyword emphasis and auto-indent.
- Error Jump and On-line Help
Errors that occur during builds are displayed in the output window at the bottom of the screen.
To make a “Tag-jump” Double-click Mouse. Once on the error press “F1 key” for a more detailed error display.
- Cooperation with Commercially Available Editors
To meet developers’ requests to use editors to which they are accustomed, SOFTUNE can be configured to use the following commercially available editors:
Codewright32, TextPAD32 and others.

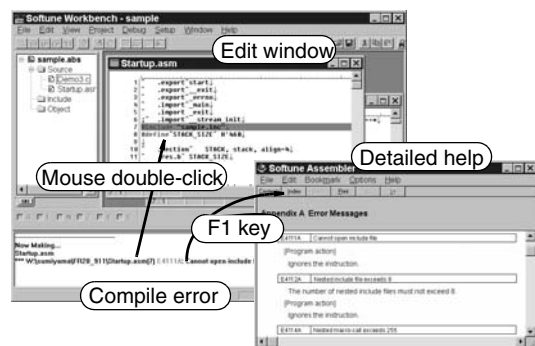

(3) Customizable Environment

When sharing files, cooperation with source generation management tools is assured, and file type conversion tools are called up, so that each person can operate in his or her own customized developing environment.

4. Debugger Function

SOFTUNE Workbench supports three debuggers that are needed at various stages of development. The appropriate debugger environment can be selected to match the situation.

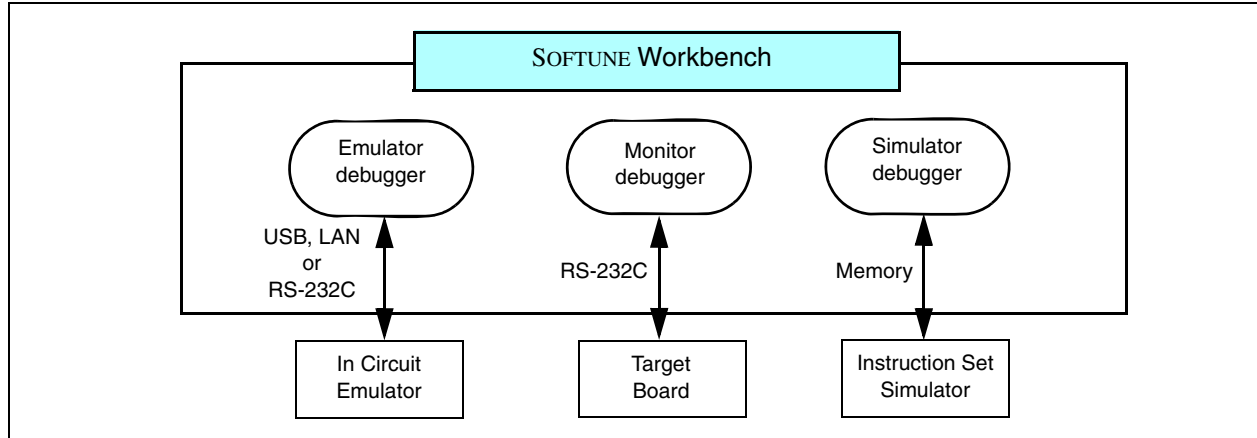

(1) Easy-to see Screen Information

The user can freely change the screen layout by selecting the necessary windows. In addition, the displayed information can be selected to provide only the information that is necessary.

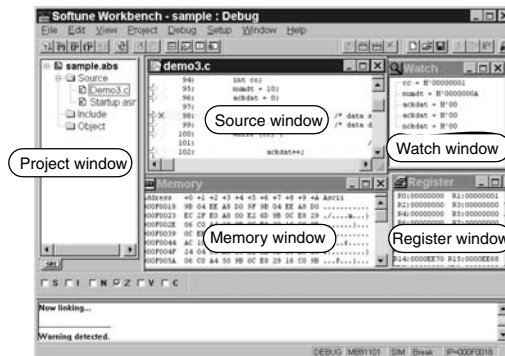

(2) Simple Environment Setting

- Debugging Environment: Setup Wizard
The setup wizard supports the selection of communication lines with emulator and boards, as well as window settings.
- MCU Operating Environment
The so-called "CPU information file," which contains the information required to support all MCUs, is provided as standard. Necessary information such as I/O port locations, ROM/RAM capacity and initial addresses can be set automatically.
- Saving and Restoring the Debugging Environment
Previous debugging environment specification, such as window locations, breakpoint settings, and memory mapping information, are saved, so that these settings are restored the next time the program is initiated.

5.Cooperation

In cooperation with SOFTUNE Workbench, the following SOFTUNE components help improve the quality of C-language programming, which greatly increases reviewing and documentation efficiency.

1) SOFTUNE C/C++ Checker

Designed to meet the following requests from beginners through to advanced users:

- Eliminate all coding mistakes.
- Review programs quickly and efficiently.
- Enable even C-language beginners to create quality code.
- Maximize coding skills.
- Use software assets on Fujitsu Microelectronics CPUs.

The SOFTUNE C Checker checks code for maintainability, methods of expanding specifications and transportability; indicates areas where quality and performance could be improved; and reports these results to the user. The user can then review the C-language code.Outline

Recent software (ROM) for embedded microcontrollers has been developed in the C language. However, it is difficult to understand messages which are output from a compiler unless the language specifications are well known.

This development support tool checks C-source programs to display and print advice for better quality and performance. It also has the facility for selecting necessary advice carefully.

(1) Features

- Outputs advice suitable for objectives: Portability, coding error performance, porting to Fujitsu Microelectronics CUP's
- Allows customization to a programmers level.
- Works with C compilers for Fujitsu microcontrollers.
- Provides easy operation and simple display over a GUI.

(2) Advising Function

The following pieces of advice are given. "Reason of Check", "Example of Program", "Suggestion of Correction", and "One-point Advice" are displayed and explained for each check item.

- Portability

This tool makes a close check on the items "processing-defined operation" and "undefined operation" which can be problems in portability in the ANSI standard.

It also gives an explanation of the operation of C compilers (fcc911 and cc907) for Fujitsu microcontrollers.

For example, the tool gives the user proper advice on many problems (such as a data type acceptable to a structure, code, and its arrangement) at the time of printing.
- Coding error

This tool indicates the items which are not wrong in the language specifications but may cause an error and the items which are logically inconsistent.

For example, the equivalent expression "if (a==0)" in the if statement is likely to be typed as the assignment expression "if (a=0)" by mistake. Most compilers cannot detect such an error.
- Performance

This tool indicates the items which generally provide better performance and the items which are essential and effective for the FR family and F²MC-16 family.

Stress is especially, put on the detection of object size reduction which can be a problem in software for embedded microcontrollers.

For example, if a function return value is a structure of the double type, an area is reserved for the return value and an object to be transferred to the area is output.
- This tool advises the user to transfer the function return value by a pointer and largely reduce the objects size.
- Porting to Fujitsu Microelectronics CUP's

This tool advises the user what to consider in porting existing software from other makers' CPU to Fujitsu Microelectronics CPU in the FR family and F²MC-16 family.

For example, in porting software resources created for the F²MC-16 family to the FR family, this tool advises the user to delete the expansion specifications (`__far`, `__near`, and `__direct` etc.) inherent to the F²MC-16 family.

- Indicated messages output

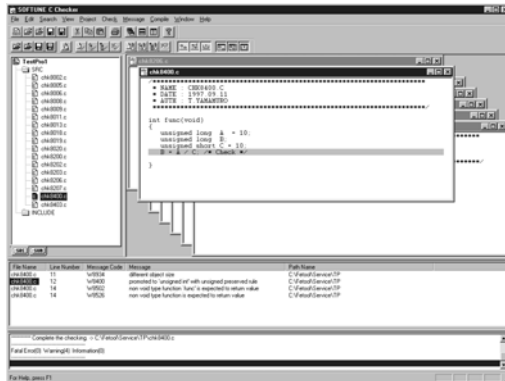

- Coding error indicated and advice displayed

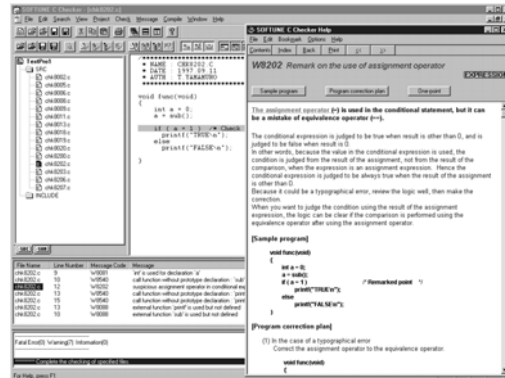

- Advice for porting to Fujitsu C compilers displayed

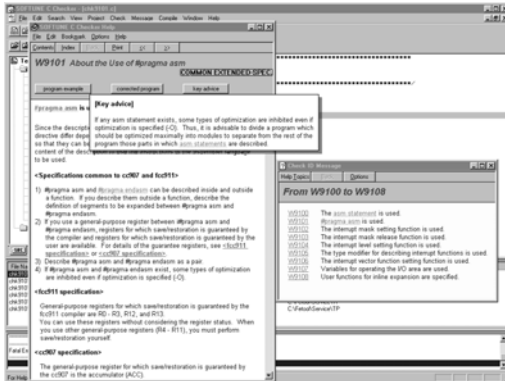

- Messages indicated on quality listed

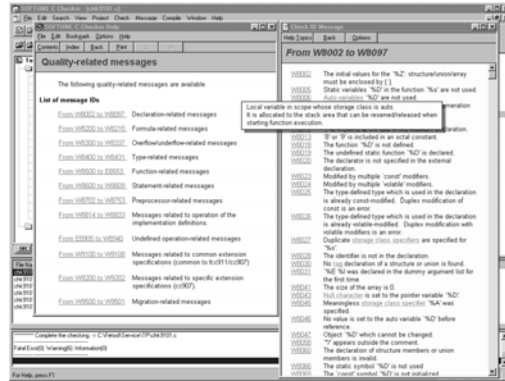

2) SOFTUNE C/C++ Analyzer

Designed to meet the following user situations:

- One wishes to examine a program's structure or processing, but the programmer is absent or documentation is unavailable.
- During program development, one wishes to create a structural program that takes into account structure and processing.
- One wishes to examine the range of effects that altering a program will create.
- One wishes to create a program's internal documentation.
- One wishes to explore the possibilities of a more efficient program.

The structure and usage of data in a C-language source programs are displayed visually, and the internal data structure, functional tree, stack usage and other information can be acquired and stored in a file.

(1) Outline

Recent software (ROM) for embedded microcontrollers is increasingly extending its development scale. This situation is created from development by many programmers, diversion of existing resources, and use of package programs.

This development support tool statically analyzes the C-source program to visually display and print the function-to-function structure, reference data, and statistical data. This tool creates data necessary for design and maintenance, as well as having a feature peculiar to C compilers for Fujitsu Microcontrollers (a feature of calculating the maximum amount of stacks used), considering its embedded feature.

(2) Features

- Displays and prints the function-to-function structure, reference data, and statistical data.
- Supports the embedded capability of C compilers for Fujitsu microcontrollers.
- Provides easy operation and simple display over a GUI.

(3) Explanation of Features

The following data is enabled for development, maintenance, and higher porting efficiency.

- **Graphic flow**
This feature block-structures function calls for visual display. It also allows the display of the entire function and calls from any function and the retrieval of functions.
- **Logic flow**
This feature visually displays the internal structure of the C-source program. For example, it shapes the control structure of `for` and `switch` statements and structure declarations. A jump feature for retrieval by functions, variable, tag, and macro names is also provided.
- **Displaying statistical data**
This feature displays the complexity and line count of a programs every function, the source of destination function name, and the count of appearance of (`if`, `for` and `asm` statements etc.).
- **Displaying argument data**
This feature displays data about the function-called file name and line number, the return value of the declared function, and the type of argument. It also checks the adjustability of dummy argument with actual argument.
- **Displaying cross-reference data**
This feature displays data about the functions and variables that a function is using, tag and macro declarations, and the appearing line number.
- **Displaying global data**
This feature displays the function using global variables. It also detects unused global variables.
- **Program checking**
This feature checks and displays the adjustability of dummy argument with actual argument.
- **Calculating the maximum amount of stacks used**
This feature calculates and displays the amount of stacks used in the entire function, as well as in any function. This calculation is made on the basis of the output of C compilers (fc911 and cc907) for Fujitsu microcontrollers (FR family and F²MC-16 family).
- **Displaying graphic flow**

- **Displaying logic flow, statistical and cross-reference data**

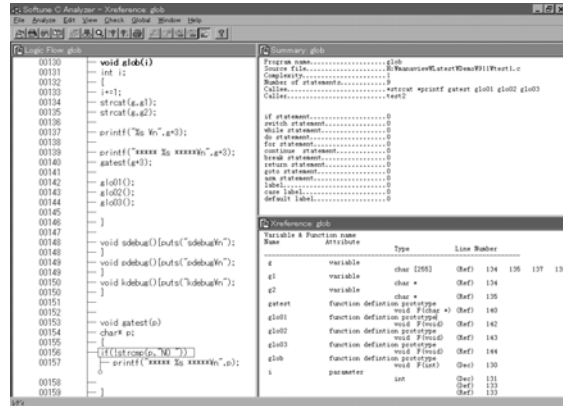
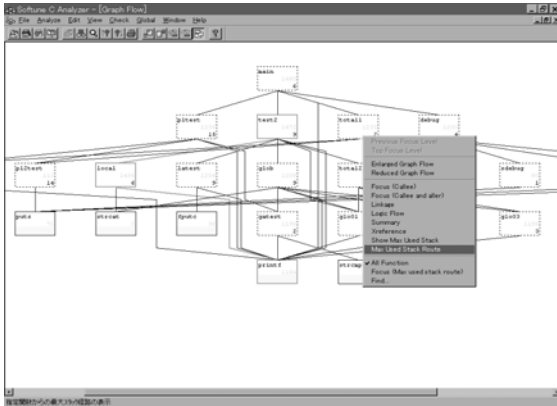

- **Displaying logic flow (focus), argument and global data**

- **Displays stack use volume (green numbers) and largest stack configuration (orange numbers)**

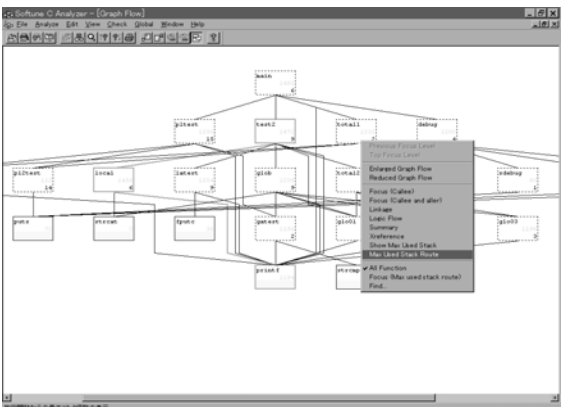
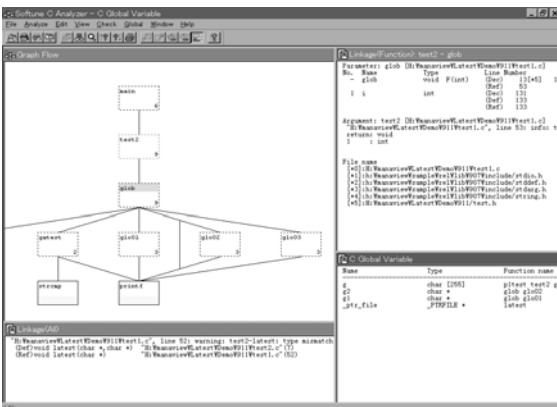

3) SOFTUNE C/C++ Compiler

- Complies with the ANSI C, ISO/ANSI C++, and EC++ specifications
Complies with ISO/IEC 9899-1990 and ISO/IEC 14882-1998
- Advanced general-purpose optimization function
Performs a detailed analysis of the program to optimize the code at the global, local, and instruction levels.
- Optimize for code size function
When the -Ksize option is specified, the compiler optimizes the program to reduce the code size.
- Optimize for execution speed function
When the -Kspeed option is specified, the compiler optimizes the program to improve the execution speed.
- Supports extended functions for embedded applications
The compiler supports a range of extended functions for embedded applications, including an assembly language function, interrupt coding function, and I/O access function.
- Supports automatic generation of C++ templates
Together with the linker, the compiler generates template instances with minimum object size without involving any complicated procedures.

6. μITRON3.0 Compliant Real Time OS for FR Family (SOFTUNE REALOS/FR)

(1) Overview

SOFTUNE REALOS/FR is the real time OS for the FR Family of Fujitsu Microelectronics proprietary 32-bit MCUs, conforming to the μITRON3.0 specifications known as the Japanese industry standard.

• Features

- μITRON 3.0 specifications
- System design customized for 32-bit MCUs for control purposes
- High-speed dispatch and interrupt processing
- In-line expansion of service call functions
- Providing a sample I/O driver
- Easy-to-use GUI-based configurator
- Graphical analysis tool REALOS Analyzer

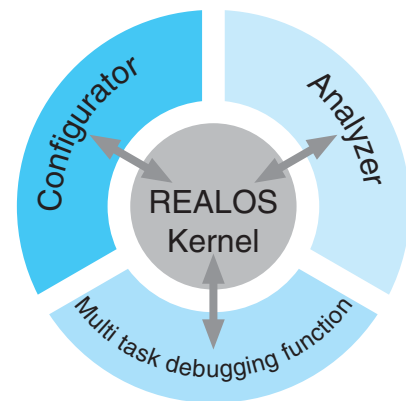

• REALOS/FR Specifications

Name	Description
Target CPU	FR
Maximum number of task	32, 767
Maximum number of priority levels	32
Scheduling method	Priority-base, event-driven type
Number of system calls	58
Complying specifications	μITRON 3.0 specifications
Kernel coding	Assembly language
Application coding	C and Assembly Languages
Kernel size	About 2.7 KB (resident) to About 8.4 KB (maximum configuration)

(2) Configuration

• Kernel

The kernel provides the basic functions of the real time OS. It is an event-driven, multitasking real time OS.

The functions to be used by application programs can be selected as system calls.

• System calls

Function	Instruction	Description
Task management functions	sta_tsk ext_tsk ter_tsk dis_dsp ena_dsp chg_pri rot_rdq rel_wai get_tid ref_tsk	Start task Exit local task Terminate remote task Disable dispatch Enable dispatch Change task priority Rotate task ready queue Release remote task from wait state Get local task ID Reference task status
Task-supplied synchronization functions	sus_tsk rsm_tsk frsm_tsk slp_tsk tslp_tsk wup_tsk can_wup	Force remote task into wait state Resume task in forced wait state Force task in forced wait state to resume execution Put local task into sleep state Put local task into sleep state (to sleep until time-out) Wake up remote task Cancel task walk-up request
Synchronization/transmission functions	sig_sem wai_sem preq_sem ref_sem	Return semaphore resource Poll semaphore resource Poll semaphore resource (polling) Reference semaphore status
	set_flg clr_flg wai_flg pol_flg twai_flg ref_flg	Set event flag Clear event flag Wait for event flag Wait for event flag (polling) Wait for event flag (with time-out) Reference event flag status
	snd_msg rcv_msg prcv_msg trcv_msg ref_mbx	Send data to mailbox Receive data from mailbox Poll and receive message from mailbox (polling) Receive data from mailbox (with time-out) Reference mailbox status
Variable length memory pool	get_blk pget_blk rel_blk ref_mpl	Get variable length memory block Get variable length memory block (polling) Return variable length memory block Reference variable length memory block
Fixed length memory pool	get_blf pget_blf tget_blf rel_blf ref_mpl	Get fixed length memory block Get fixed length memory block (polling) Get fixed length memory block (with time-out) Return fixed length memory block Reference fixed length memory block status
Interrupt management function	ret_int loc_cpu uni_cpu chg_ilm ref_ilm	Return from interrupt handler Disable interrupt and dispatch Enable interrupt and dispatch Change interrupt level Reference interrupt level status
Time c functions	set_tim get_tim dly_tsk def_cyc act_cyc ref_cyc def_alm ref_alm ret_tmr	Set system clock Reference system clock Delay task Define cyclic handler Activate/control cyclic handler Reference cyclic handler status Define alarm handler Reference alarm handler status Return from timer handler
System management function	get_ver ref_sys	Get version number Reference system status

- **Sample programs**

Sample programs are provided as practical coding examples for user training purposes.

- **REALOS Configurator**

The configurator helps when setting conditions for creating the REALOS kernel, Necessary settings are made according to the display on the configurator screen, simplifying kernel configuration.

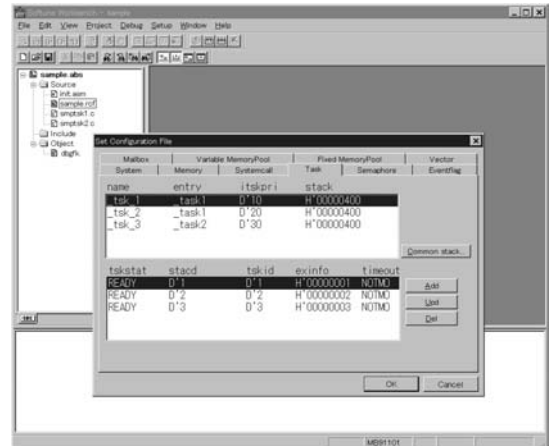

- **REALOS Analyzer**

The performance of the system by which REALOS is built in and the state transition of the task are analyzed and displayed by Graphic.

- Displaying object conditions
- OS break (execution break, access break, dispatcher break, service call/system call break)
- Issuing a service call/system call
- Task transition flow
- Stack status
- Task context watch

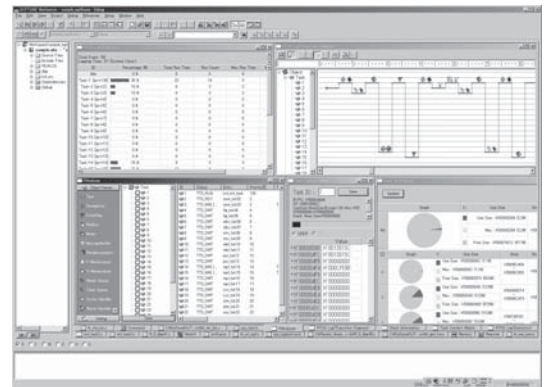

7. μ ITRON4.0 specifications compliant Real Time OS for FR Family (SOFTUNE REALOS/FR Spec.4)

(1) Overview

SOFTUNE REALOS/FR Spec.4 is the real time OS for the FR Family of Fujitsu Microelectronics proprietary 32-bit MCUs, conforming to the μ ITRON4.0 specifications.

• Features

- μ ITRON4.0 specifications
- System design customized for 32-bit MCUs for control purposes
- High-speed dispatch and interrupt processing
- Support for dynamic creation and deletion of a object
- Support for Mutex, Message buffer and so on
- In-line expansion of service call functions
- Providing sample I/O drivers
- Easy-to-use GUI-based REALOS configurator
- Graphical analysis tool REALOS Analyzer

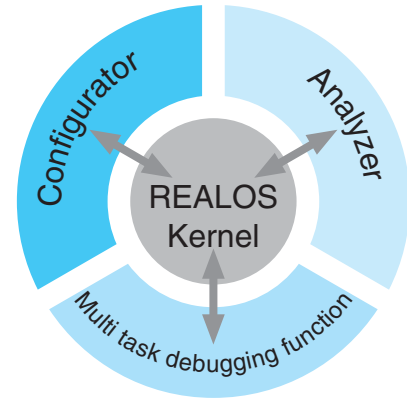

• REALOS/FR Spec.4 Specifications

Name	Description
Target CPU	FR
Maximum number of task	32,767
Maximum number of priority levels	1,024
Scheduling method	Priority-base, event-driven type
Number of service calls	128
Complying specifications	μ ITRON4.0 specifications
Kernel coding	C and Assembly Languages
Application coding	C and Assembly Languages
Kernel size	About 11 KB (resident) to About 44 KB (maximum configuration)

(2) Configuration

• Kernel

The kernel provides the basic functions of the real time OS.

It is an event-driven, multitasking real time OS.

The functions to be used by application programs can be selected as service calls.

• Service calls

Function	Instruction	Description
Task Management Functions	cre_tsk	Create Task
	acre_tsk	Create Task (ID Number Automatic Assignment)
	del_tsk	Delete Task
	act_tsk	Activate Task
	can_act	Cancel Task Activation Requests
	sta_tsk	Activate Task (with a Start Code)
	ext_tsk	Terminate Invoking Task
	exd_tsk	Terminate and Delete Invoking Task
	ter_tsk	Terminate Task
	chg_pri	Change Task Priority
	get_pri	Reference Task Priority
	ref_tsk	Reference Task State
	ref_tst	Reference Task State (Simplified Version)
Task Dependent Synchronization Functions	slp_tsk	Put Task to Sleep
	tslp_tsk	Put Task to Sleep (with Time-out)
	wup_tsk	Walk-up Task
	can_wup	Cancel Task Walk-up Requests
	rel_wai	Release Task from Waiting
	sus_tsk	Suspend Task
	rsm_tsk	Resume Suspended Task
	frsm_tsk	Forcibly Resume Suspended Task
dly_tsk	Delay Task	
Task Exception Handling Functions	def_tex	Define Task Exception Handling Routine
	ras_tex	Raise Task Exception Handling
	dis_tex	Disable Task Exceptions
	ena_tex	Enable Task Exceptions
	sns_tex	Reference Task Exception Handling State
ref_tex	Reference Task Exception Handling State	
Synchronization and Communication Functions	cre_sem	Create Semaphore
	acre_sem	Create Semaphore (ID Number Automatic Assignment)
	del_sem	Delete Semaphore
	sig_sem	Release Semaphore Resource
	wai_sem	Acquire Semaphore Resource
	pol_sem	Acquire Semaphore Resource (Polling)
	twai_sem	Acquire Semaphore Resource (with Time-out)
	ref_sem	Reference Semaphore State
	cre_flg	Create Event flag
	acre_flg	Create Event flag (ID Number Automatic Assignment)
	del_flg	Delete Event flag
	set_flg	Set Event flag
	clr_flg	Clear Event flag
	wai_flg	Wait for Event flag
	pol_flg	Wait for Event flag (Polling)
twai_flg	Wait for Event flag (with Time-out)	
ref_flg	Reference Event flag Status	
cre_dtq	Create Data Queue	
acre_dtq	Create Data Queue (ID Number Automatic Assignment)	
del_dtq	Delete Data Queue	
snd_dtq	Send to Data Queue	
psnd_dtq	Send to Data Queue (Polling)	
tsnd_dtq	Send to Data Queue (with Time-out)	
fsnd_dtq	Forced Send to Data Queue	
rcv_dtq	Receive from Data Queue	
prcv_dtq	Receive from Data Queue (Polling)	
trcv_dtq	Receive from Data Queue (with Time-out)	
ref_dtq	Reference Data Queue State	
cre_mbx	Create Mailbox	
acre_mbx	Create Mailbox (ID Number Automatic Assignment)	
del_mbx	Delete Mailbox	
snd_mbx	Send to Mailbox	
rcv_mbx	Receive from Mailbox	
prcv_mbx	Receive from Mailbox (Polling)	
trcv_mbx	Receive from Mailbox (with Time-out)	
ref_mbx	Reference Mailbox State	

Function	Instruction	Description
Extended Synchronization and Communication Functions	cre_mtx	Create Mutex
	acre_mtx	Create Mutex (ID Number Automatic Assignment)
	del_mtx	Delete Mutex
	loc_mtx	Lock Mutex
	ploc_mtx	Lock Mutex (Polling)
	tloc_mtx	Lock Mutex (with Time-out)
	unl_mtx	Unlock Mutex
	ref_mtx	Reference Mutex State
	cre_mbf	Create Message Buffer
	acre_mbf	Create Message Buffer (ID Number Automatic Assignment)
del_mbf	Delete Message Buffer	
snd_mbf	Send to Message buffer	
psnd_mbf	Send to Message buffer (Polling)	
tsnd_mbf	Send to Message buffer (with Time-out)	
rcv_mbf	Receive from Message Buffer	
prcv_mbf	Receive from Message Buffer (Polling)	
trcv_mbf	Receive from Message Buffer (with Time-out)	
ref_mbf	Reference Message Buffer State	
Fixed-Sized Memory Pools	cre_mpf	Create Fixed-Sized Memory Pool
	acre_mpf	Create Fixed-Sized Memory Pool (ID Number Automatic Assignment)
	del_mpf	Delete Fixed-Sized Memory Pool
	get_mpf	Acquire Fixed-Sized Memory Block
	pget_mpf	Acquire Fixed-Sized Memory Block (Polling)
tget_mpf	Acquire Fixed-Sized Memory Block (with Time-out)	
rel_mpf	Release Fixed-Sized Memory Block	
ref_mpf	Reference Fixed-Sized Memory Pool State	
Variable-Sized Memory Pools	cre_mpl	Create Variable-Sized Memory Pool
	acre_mpl	Create Variable-Sized Memory Pool (ID Number Automatic Assignment)
	del_mpl	Delete Variable-Sized Memory Pool
	get_mpl	Acquire Variable-Sized Memory Block
	pget_mpl	Acquire Variable-Sized Memory Block (Polling)
	tget_mpl	Acquire Variable-Sized Memory Block (with Time-out)
	rel_mpl	Release Variable-Sized Memory Block
ref_mpl	Reference Variable-Sized Memory Pool State	
Time Management Functions	set_tim	Set System Time
	get_tim	Reference System Time
	isig_tim	Supply Time Tick
	cre_cyc	Create Cyclic Handler
	acre_cyc	Create Cyclic Handler (ID Number Automatic Assignment)
	del_cyc	Delete Cyclic Handler
	sta_cyc	Start Cyclic Handler Operation
	stp_cyc	Stop Cyclic Handler Operation
	ref_cyc	Reference Cyclic Handler State
	cre_alm	Create Alarm Handler
	acre_alm	Create Alarm Handler (ID Number Automatic Assignment)
del_alm	Delete Alarm Handler	
sta_alm	Start Alarm Handler Operation	
stp_alm	Stop Alarm Handler Operation	
ref_alm	Reference Alarm Handler State	
System State Management Functions	rot_rdq	Rotate Task Precedence
	get_tid	Reference Task ID in the RUNNING State
	loc_cpu	Lock the CPU
	unl_cpu	Unlock the CPU
	dis_dsp	Disable Dispatching
	ena_dsp	Enable Dispatching
	sns_ctx	Reference Contexts
	sns_loc	Reference CPU State
	sns_dsp	Reference Dispatching State
sns_dpn	Reference Dispatch Pending State	
ref_sys	Reference System State	
Interrupt Management Functions	chg_ilm	Change Interrupt Mask
	get_ilm	Reference Interrupt Mask
System Configuration Management Functions	ref_cfg	Reference Configuration Information
	ref_ver	Reference Version Information

- **Sample programs**

Sample programs are provided as practical coding examples for user training purposes.

- **REALOS Configurator**

The configurator helps when setting conditions for creating the REALOS kernel, Necessary settings are made according to the display on the configurator screen, simplifying kernel configuration.

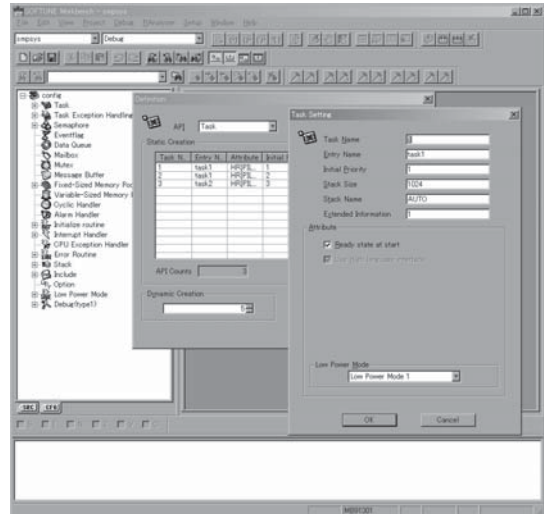

- **REALOS Analyzer**

The performance of the system by which REALOS is built in and the state transition of the task are analyzed and displayed by Graphic.

- Displaying object conditions
- OS break (execution break, access break, dispatcher break, service call/system call break)
- Issuing a service call/system call
- Task transition flow
- Stack status
- Task context watch

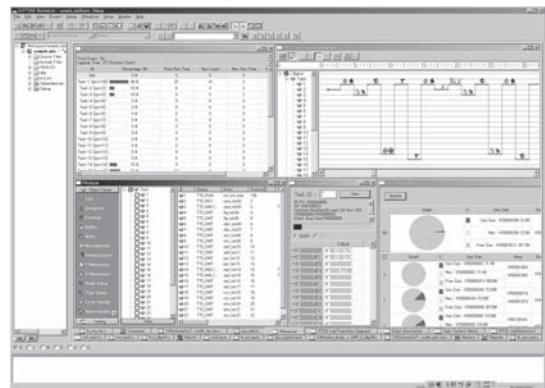

8. μ T-Kernel Specifications Compliant Real-Time OS for FR Family (SOFTUNE μ T-REALOS/FR)

(1) Overview

SOFTUNE μ T-REALOS/FR is the real time OS for the FR Family of Fujitsu Microelectronics proprietary 32-bit MCUs, it is the next generation realtime Operating System conforming to the μ T-Kernel specifications.

• Features

- μ T-Kernel specifications
- System design customized for 32-bit MCUs for control purposes
- High-speed dispatch and interrupt processing
- High-speed system call processing by function call
- Shift support by μ ITRON interchangeable API
- Customizing of kernel by optimization function
- Power saving by power control function in each task
- Providing sample I/O drivers
- Easy-to-use GUI-based REALOS configurator
- Graphical analysis tool REALOS Analyzer

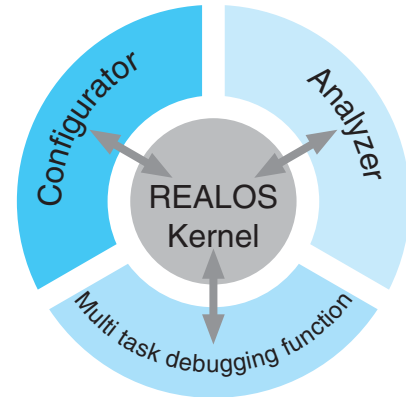

• μ T-REALOS/FR Specifications

Name	Description
Target CPU	FR
Maximum number of task	32,767
Maximum number of priority levels	1,024
Scheduling method	Priority-base, event-driven type
Number of service calls	108
Complying specifications	μ T-Kernel specifications
Kernel coding	C and Assembly Languages
Application coding	C and Assembly Languages

(2) Configuration

• Kernel

The kernel provides the functions of the real time OS.

It is an event-driven, multitasking real time OS.

The functions to be used by application programs can be selected.

• Service calls

Function	Instruction	Description
Task Management	tk_cre_tsk	Generate Task
	tk_del_tsk	Delete Task
	tk_sta_tsk	Starte Task
	tk_ext_tsk	End Task
	tk_ext_d_tsk	Ende and delete Task
	tk_ter_tsk	Cancel Another task
	tk_chg_pri	Change priority of the task
	tk_ref_tsk	Refer to the state of the task
	tk_set_reg	Acquir task register
	tk_get_reg	Set task register
Task attachment synchronization	tk_slp_tsk	The task is shifted to the getting up waiting state
	tk_wup_tsk	Get up another task
	tk_can_wup	Nullified the getting up demand for the task
	tk_rel_wai	Released the waiting state of another task
	tk_sus_tsk	Another task is shifted to the compulsion waiting state
	tk_rsm_tsk	Restarted the task of the compulsion waiting state
	tk_frm_tsk	Restarts the task of the compulsion waiting state compulsion
tk_dly_tsk	The task is shifted to the waiting state of the passage of time	
Synchronization and Communication	tk_cre_sem	The semaphore is generated
	tk_del_sem	The semaphore is deleted
	tk_wai_sem	The semaphore resource is acquired
	tk_sig_sem	The semaphore resource is returned
	tk_ref_sem	Refer to the state of the semaphore
	tk_cre_flg	The event flag is generated
	tk_del_flg	The event flag is deleted
	tk_set_flg	The event flag is set
	tk_clr_flg	The event flag is cleared
	tk_wai_flg	The event flag is waited for
	tk_ref_flg	Refer to the state of the event flag
	tk_cre_mbx	The mailbox is made
	tk_del_mbx	The mailbox is deleted
	tk_snd_mbx	Sent to mailbox
tk_rcv_mbx	Received from mailbox	
tk_ref_mbx	Refer to the state of the mailbox	
Enhancing Synchronization and Communication	tk_cre_mtx	Mutex is generated
	tk_del_mtx	Mutex is deleted
	tk_loc_mtx	Mutex is locked
	tk_unl_mtx	Mutex is unlocked
	tk_ref_mtx	Refer to the state of mutex
	tk_cre_mbf	The message buffer is generated
	tk_del_mbf	The message buffer is deleted
	tk_snd_mbf	Sent to message buffer
	tk_rcv_mbf	Received from message buffer
	tk_ref_mbf	Refer to the state of the message buffer
	tk_cre_por	The rendezvous port is generated
	tk_del_por	The rendezvous port is deleted
	tk_cal_por	The rendezvous to the rendezvous port is called
	tk_acp_por	The rendezvous to the rendezvous port is accepted
	tk_fwd_por	The rendezvous to the rendezvous port is forwarded
	tk_rpl_rdv	It answers the rendezvous to the rendezvous port
	tk_ref_por	Refer to the state of the rendezvous port.

Function	Instruction	Description
Memory pool management	tk_cre_mpf	The fixed length memory pool is generated
	tk_del_mpf	The fixed length memory pool is deleted
	tk_get_mpf	The fixed length memory block is acquired
	tk_rel_mpf	The fixed length memory block is returned
	tk_ref_mpf	Refer to the state of the fixed length memory pool
	tk_cre_mpl	The variable-length memory pool is generated
	tk_del_mpl	The variable-length memory pool is deleted
	tk_get_mpl	The variable-length memory block is acquired
	tk_rel_mpl	The variable-length memory block is returned
	tk_ref_mpl	Refer to the state of the variable-length memory pool
Management at time	tk_set_tim	The system time is set
	tk_get_tim	Refer to the time of the system now
	tk_get_otm	Refer to the system operating time
	tk_cre_cyc	The cycle handler is generated
	tk_del_cyc	The cycle handler is deleted
	tk_sta_cyc	The operation of the cycle handler begins
	tk_stp_cyc	The operation of the cycle handler is stopped
	tk_ref_cyc	Refer to the state of the cycle handler
	tk_cre_alm	The alarm handler is generated
	tk_del_alm	The alarm handler is deleted
tk_sta_alm	The operation of the alarm handler begins	
tk_stp_alm	The operation of the alarm handler is stopped	
tk_ref_alm	Refer to the state of the alarm handler	
isig_tim	Taimuticc is supplied	
Interruption management	tk_def_int	The interruption handler is defined
	tk_ret_int	It returns from the interruption handler
	DI	All external interruptions are prohibited
	EI	All external interruptions are permitted
isDI	The external interruption prohibition is examined	
System state management	tk_rot_rdq	The priority level of the task is rotated
	tk_get_tid	Refer to task ID of the running state task
	tk_dis_dsp	Dispatch is prohibited
	tk_ena_dsp	Dispatch is permitted
	tk_ref_sys	Refer to the state of the system
tk_ref_ver	Refer to the version	
Sub-system management	tk_def_ssy	The subsystem is defined
	tk_ref_ssy	Refer to subsystem definition information
Device management	tk_opn_dev	Opening of device
	tk_cls_dev	Close of device
	tk_rea_dev	Reading beginning of device
	tk_srea_dev	Synchronous reading beginning of device
	tk_wri_dev	Writing beginning of device
	tk_swri_dev	Synchronous writing beginning of device
	tk_wai_dev	Demand completion Ma of device
	tk_sus_dev	Suspension of device
	tk_get_dev	Acquisition of device name
	tk_ref_dev	Acquisition of device information
	tk_oref_dev	Acquisition of device information
	tk_lst_dev	Acquisition of device list that has been registered
tk_evt_dev	The driver demand event is transmitted the device	
Device management(device registration)	tk_def_dev	The device is registered
	tk_ref_idv	Device initial information is acquired

- **Sample programs**

Sample programs are provided as practical coding examples for user training purposes.

- **REALOS Configurator**

The configurator helps when setting conditions for creating the REALOS kernel, Necessary settings are made according to the display on the configurator screen, simplifying kernel configuration.

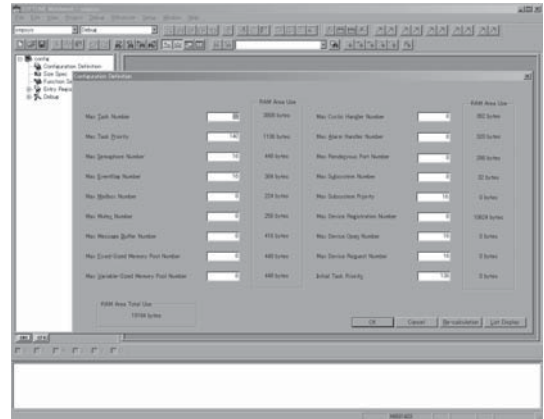

- **REALOS Analyzer**

The performance of the system by which REALOS is built in and the state transition of the task are analyzed and displayed by Graphic.

- Displaying object conditions
- OS break (execution break, access break, dispatcher break, service call/system call break)
- Issuing a service call/system call
- Task transition flow
- Stack status
- Task context watch

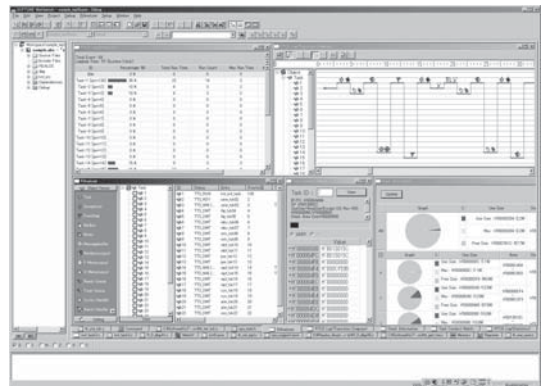

Evaluation Tools for Support Hardware FR families (MB2197 emulator)

Features

- DSU support: DSU2, DSU3
- Linear power supply voltage support from +2.7V to +5.5V
- Supports debugging of source level (assembly and C languages, a mixed indication)
- Simplified graphic interface operation execution using pull-down menu and buttons
- Real time trace function
- Displays source codes, variables, register, memory and trace on multi windows
- Hardware break × 5, software break × 8192, code event × 2, data event × 2
- Operation cycle measurement function
- Host I/F (standard accessories) : RS-232C (max 19.2 Kbps) , LAN (10BASE-2)

System Overview



System configuration

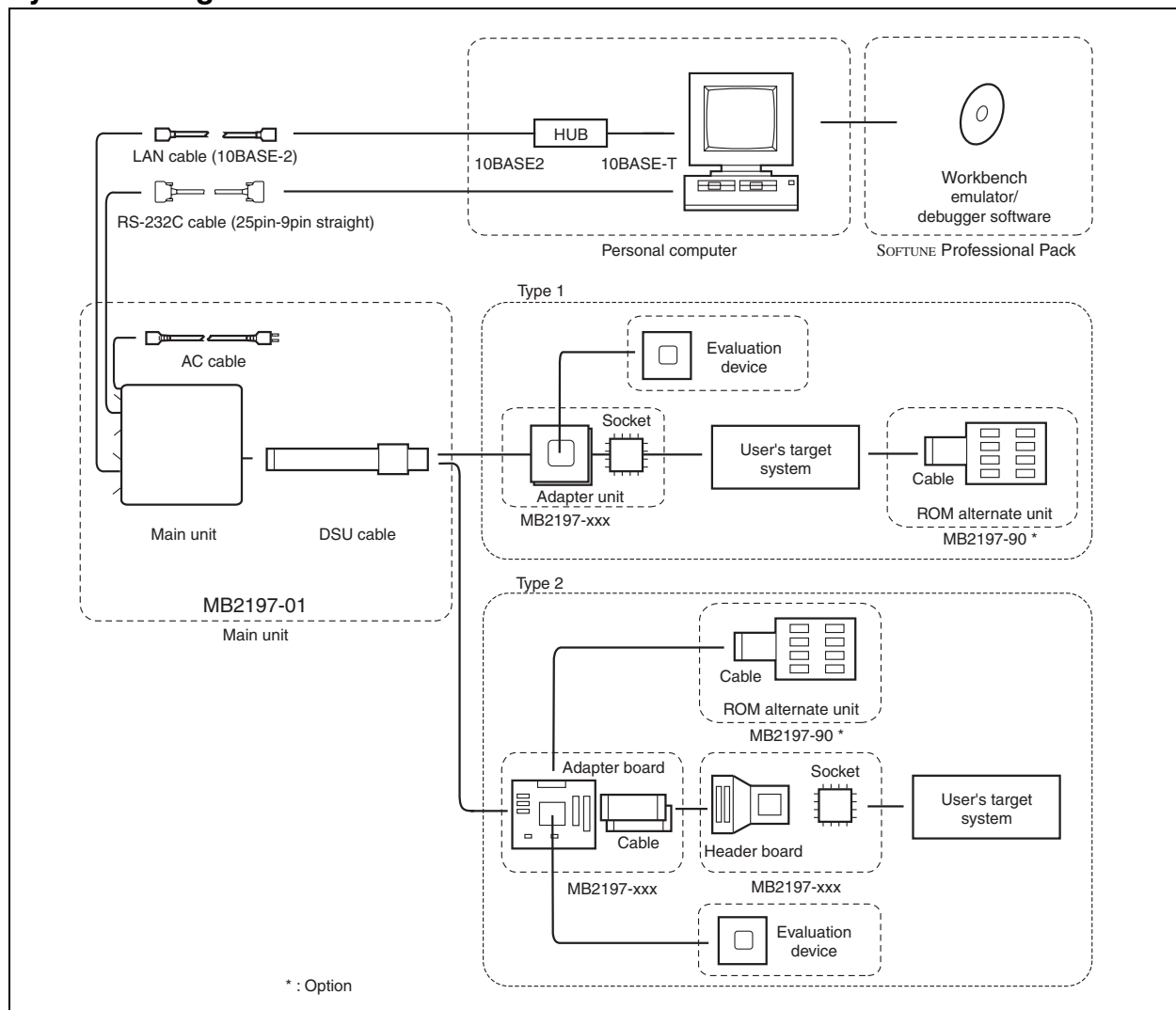

Evaluation Tools for Support Hardware FR families (MB2198 emulator)

Features

- DSU support: DSU3, DSU4
- Linear power supply voltage support from +2.7V to +5.5V
- Supports debugging of source level (assembly and C languages, a mixed indication)
- Simplified graphic interface operation execution using pull-down menu and buttons
- Real time trace function
- Displays source codes, variables, register, memory and trace on multi windows
- Hardware break × 5, software break × 4096, code event × 2, data event × 2
- Operation cycle measurement function
- Host I/F (standard accessories) : RS-232C (max 115 Kbps) , LAN (10BASE-T, 100BASE-TX) , USB 1.1

System Overview



System configuration

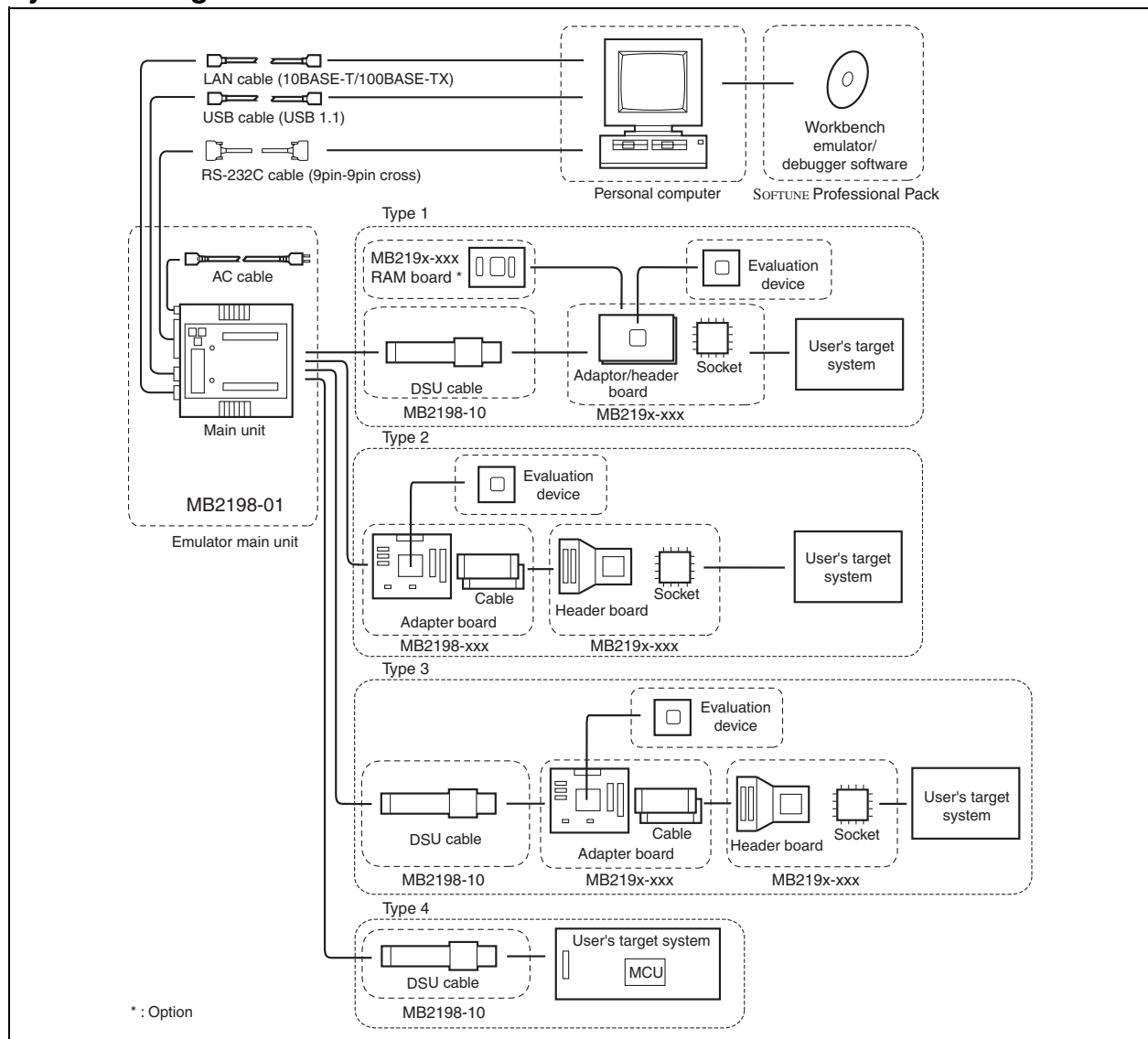

• System configuration for MB91101A, MB91107A, MB91108, MB91121

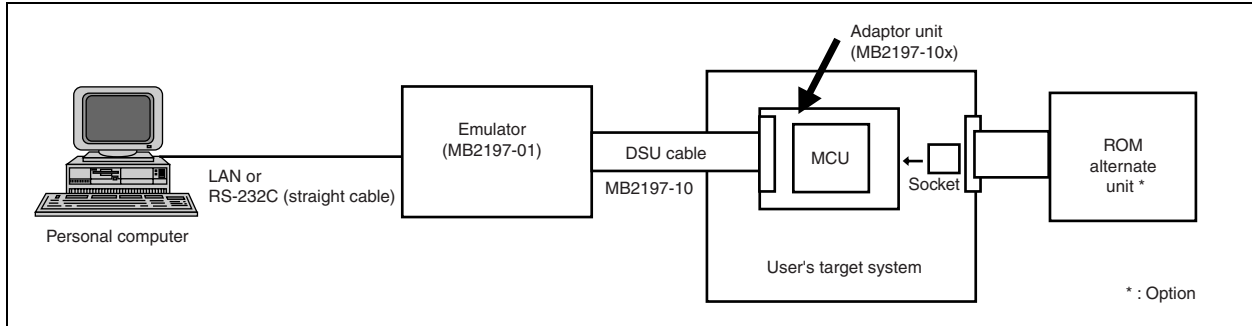

• System configuration for MB91F127, MB91F128, MB91133, MB91F133A, MB91151A, MB91154, MB91155, MB91F155A, MB91F158, MB91360

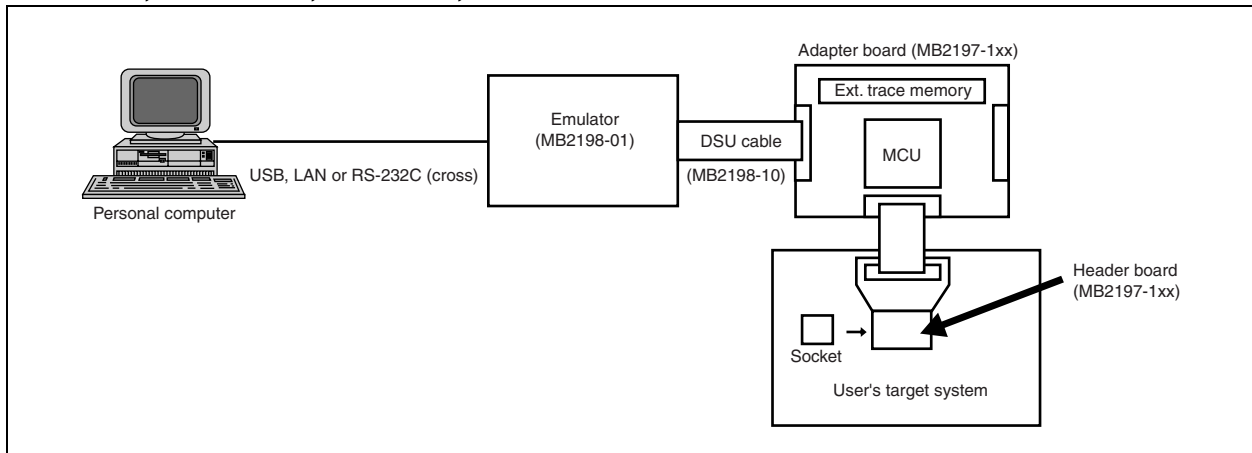

• System configuration for MB91210, MB91220, MB91230, MB91260, MB91265, MB91270, MB91350A

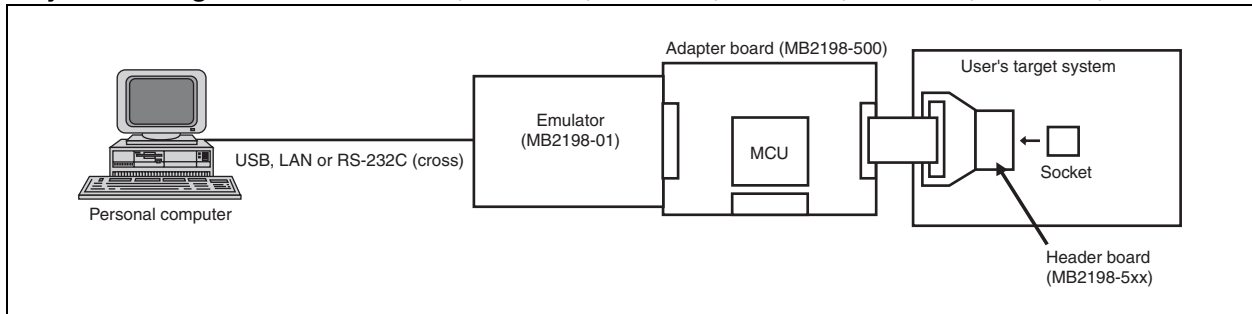

• System configuration for MB91302A

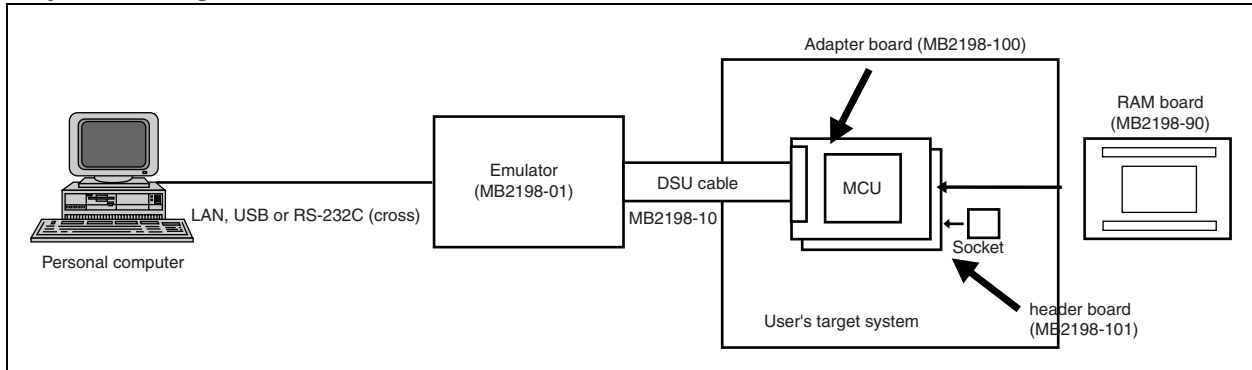

• System configuration for MB91306R, MB91307B, MB91307R

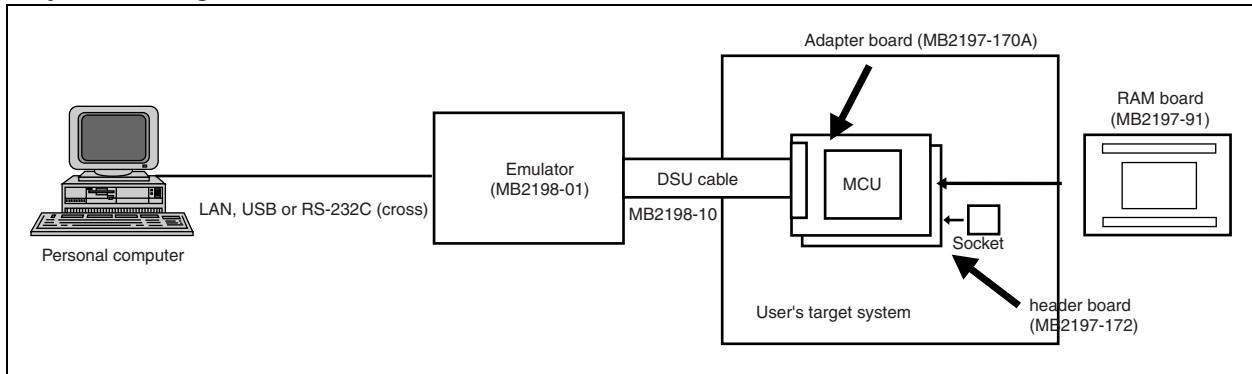

• System configuration for MB91305, MB91310, MB91313, MB91314A, MB91319, MB91345

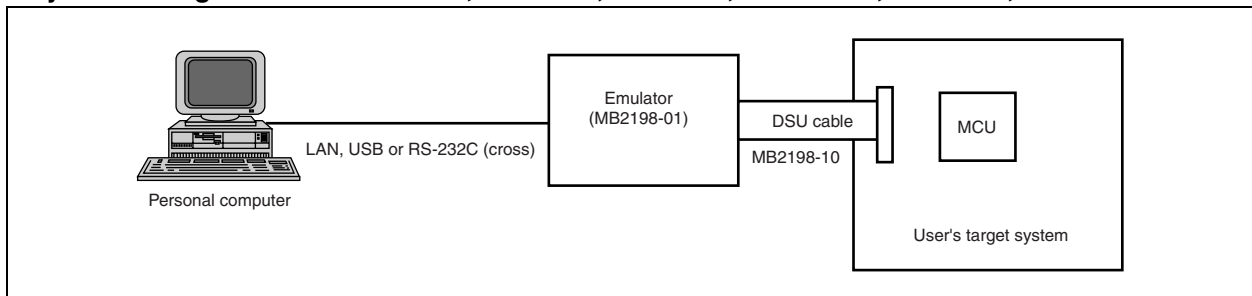

• System configuration for MB91460

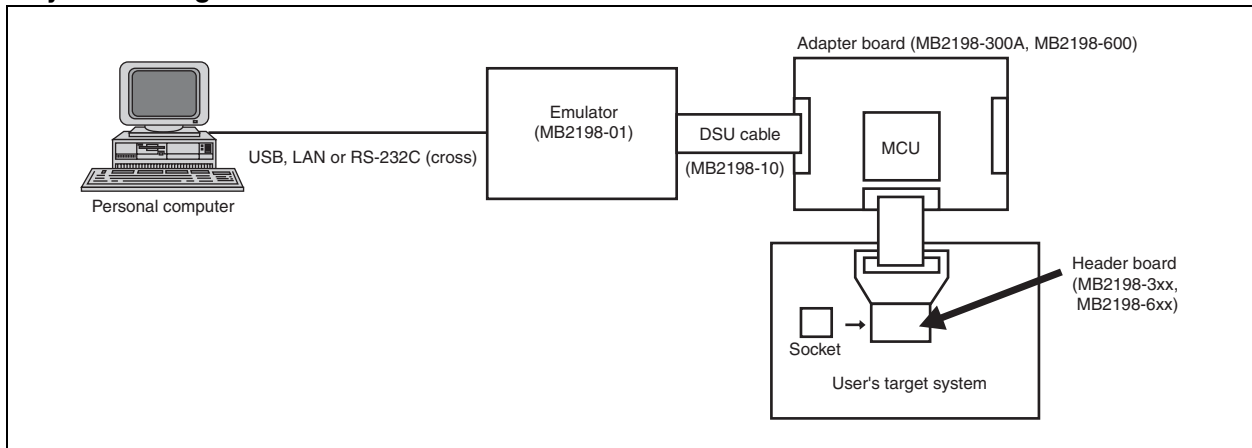

• System configuration for MB91470, MB91480

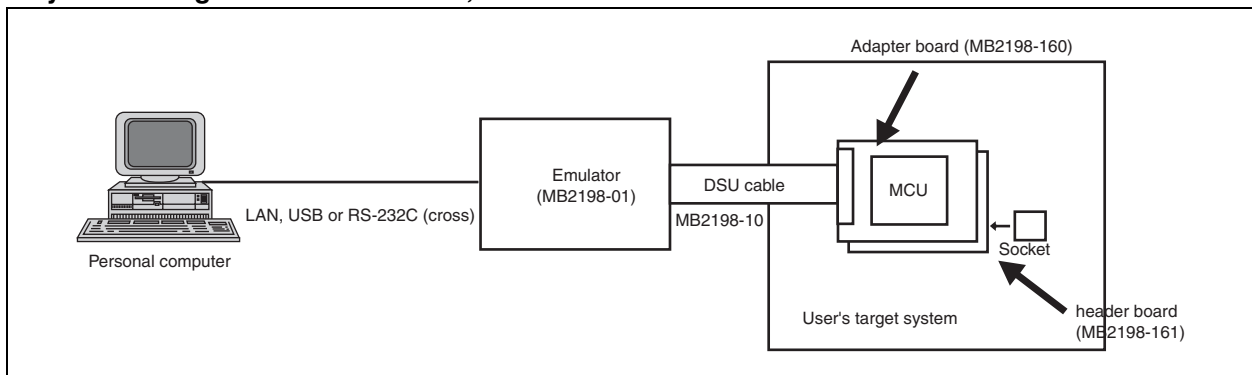

System

• For FR (DSU2/3) Emulator

Name	Part number	Remarks	Overview
Emulator main unit for FR (DSU2/3)	MB2197-01	<ul style="list-style-type: none"> The systems development support tool which used MCU for evaluating FR and builds in DSU interface. Power supply voltage: AC100V or AC200 V Dimensions: 210 mm (width) × 297 mm (depth) × 87 mm (height) Weight: 2.7 kg With MB2197-10 (DSU2/3 cable) 	
DSU2/3 cable	MB2197-10	Used to connect the emulator main unit to the adaptor unit or the adapter board.	
ROM alternate unit *	MB2197-90 (with 100-V AC adapter)	<ul style="list-style-type: none"> Option for FR family Memory board: Capable of substituting the memory on the target board Memory size: 4 Mbytes Data bus size: Selectable from among 8, 16, and 32-bit configurations Write protect function 	

*: The ROM alternate unit is directly connected to the CPU bus. To use the unit, therefore, the target board must be designed so that the unit can be connected on the board.

• For FR (DSU3/4) Emulator

Name	Part number	Remarks	Overview
Emulator main unit for FR (DSU3/4)	MB2198-01	<ul style="list-style-type: none"> The systems development support tool which used MCU for evaluating FR and builds in DSU interface. Power supply voltage: AC100V or AC200 V Dimensions: 150 mm (width) × 210 mm (depth) × 46 mm (height) Weight: 2.7 kg 	
DSU3/4 cable	MB2198-10	Used to connect the MB2198-01 to the adapter board.	
Small cable for DSU3	MB2198-201	Used to connect the MB2198-10 with user system for DSU3. <ul style="list-style-type: none"> Dimensions: 73 mm (width) × 31 mm (depth) × 7 mm (height) Includes : Connector × 1 (SICA2P20HD, made by Tokyo Eletech Ltd.) 	
Small cable for DSU4	MB2198-202	Used to connect the MB2198-10 with user system for DSU4. <ul style="list-style-type: none"> Dimensions: 67 mm (width) × 30 mm (depth) × 7 mm (height) Includes : Connector × 1 (SICA2P20HD, made by Tokyo Eletech Ltd.) 	

32-bit FR Family Support Tools

For MB91101A

In Circuit Emulator (made by Fujitsu Microelectronics)

- Standard tool

Name	Part number	Note
Evaluation device	MB91V101ACR-ES	• PGA135, DSU2
Emulator main unit for FR (DSU2/3)	MB2197-01	<ul style="list-style-type: none"> • The systems development support tool which used MCU for evaluating FR and builds in DSU interface. • Power supply voltage: AC100V or AC200 V • Dimensions: 210 mm (width) × 297 mm (depth) × 87 mm (height) • Weight: 2.7 kg • With MB2197-10 (DSU2/3 cable)

- Adapter

Name	Part number	Note
Adapter unit (LQFP-100)	MB2197-101	<ul style="list-style-type: none"> • Adapter unit to connect the user system using an LQFP100. • IC149-100-□25-B5 for MB91101A *1. The MB91V101A is required separately.
Adapter unit (QFP-100)	MB2197-102	<ul style="list-style-type: none"> • Adapter unit to connect the user system using a QFP100. • IC149-100-□14-B5 for MB91101A *1. The MB91V101A is required separately.

- Option tool

Name	Part number	Note
ROM alternate unit *3	MB2197-90 (with 100-V AC adapter)	<ul style="list-style-type: none"> • Memory board: Capable of substituting the memory on the target board • Memory size: 4 Mbytes • Data bus size: Selectable from among 8, 16, and 32-bit configurations • Write protect function

- Option

Name	Part number	Note
DSU2/3 cable	MB2197-10	Used to connect the emulator main unit to the adaptor unit or the adapter board.

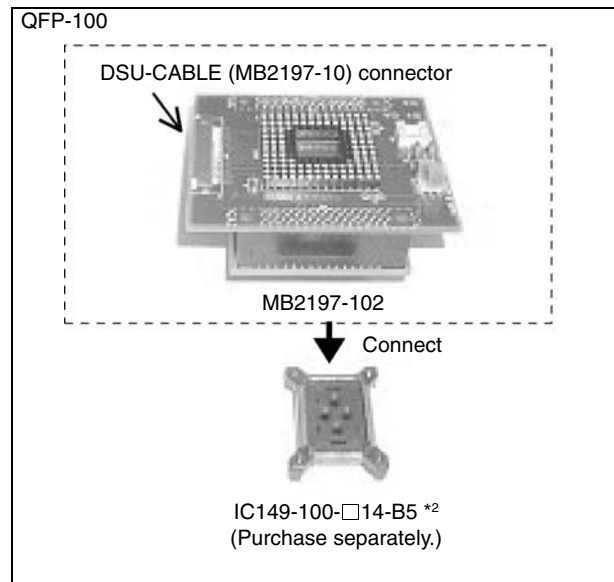
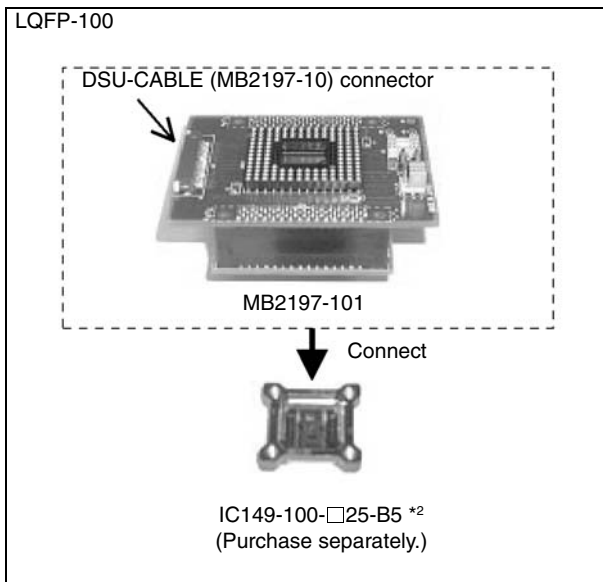

Evaluation board

Name	Part number	Note
Evaluation board (Main board)	MB91906EB	<ul style="list-style-type: none"> Main board + daughter board For 5 V, 3 V products
Daughter board for MB91101A	MB91901EB	<ul style="list-style-type: none"> For In Circuit Emulator (made by Fujitsu Microelectronics) Combined use main board (MB91906EB) Built-in MB91V101A
	MB91902EB	<ul style="list-style-type: none"> For In Circuit Emulator for MB91101A (Yokogawa Digital Computer Corporation) Combined use main board (MB91906EB)

• Simple target board

Name	Part number	Note
In Circuit Emulator Simple target board for MB91101A (FR30SRAM board)	MB91903EB	<ul style="list-style-type: none"> Main board + Simple target board Built-in MB91V101A Connection to In Circuit Emulator (made by Fujitsu Microelectronics) RAM 2 KB

*1: The adapter requires an IC socket manufactured by YAMAICHI ELECTRONICS Co., Ltd. (Separately priced)

<Contact> Yamaichi Electric Mfg. TEL: 81-3-3778-6121

*2: The IC socket is mounted on the foot pattern on the user board.

*3 : A ROM alternate unit is used connecting with a CPU bus. In the case of use, it is necessary to design so that ROM alternate unit can be connected on target board.

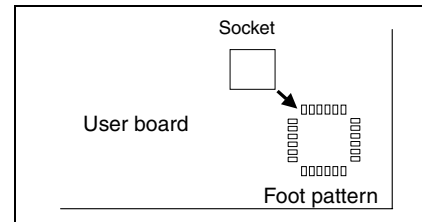

32-bit FR Family Support Tools

For MB91107A/108

In Circuit Emulator (made by Fujitsu Microelectronics)

- Standard tool

Name	Part number	Note
Evaluation device	MB91V108CR-ES	• PGA135, DSU2
Emulator main unit for FR (DSU2/3)	MB2197-01	<ul style="list-style-type: none"> • The systems development support tool which used MCU for evaluating FR and builds in DSU interface. • Power supply voltage: AC100 V or AC200 V • Dimensions: 210 mm (width) × 297 mm (depth) × 87 mm (height) • Weight: 2.7 kg • With MB2197-10 (DSU2/3 cable)
Adapter (LQFP-120)	MB2197-103	<ul style="list-style-type: none"> • Adapter unit to connect the user system using an LQFP120. • NQPACK120SD and HQPACK120SD are bundled *1 • MB91V108 is required separately

- Option tool

Name	Part number	Note
ROM alternate unit *4	MB2197-90 (with 100-V AC adapter)	<ul style="list-style-type: none"> • Memory board: Capable of substituting the memory on the target board • Memory size: 4 Mbytes • Data bus size: Selectable from among 8, 16, and 32-bit configurations • Write protect function

- Option

Name	Part number	Note
DSU2/3 cable	MB2197-10	Used to connect the emulator main unit to the adaptor unit or the adapter board.

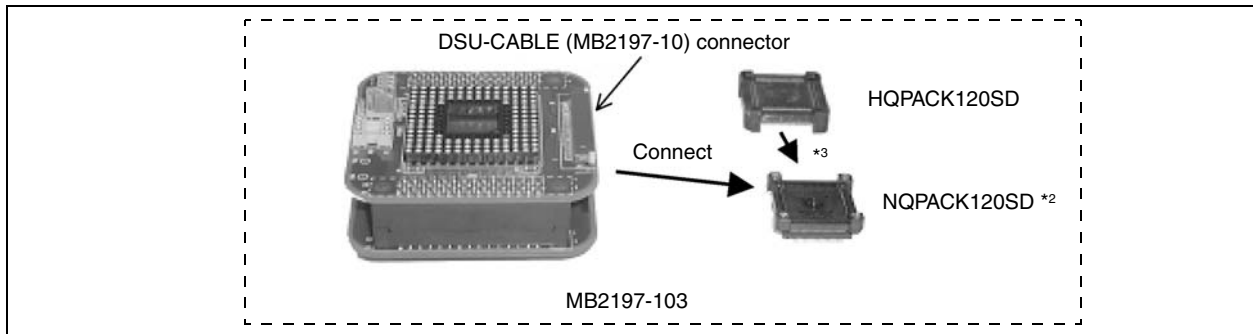

Evaluation board

Name	Part number	Note
Evaluation board (Main board)	MB91906EB	<ul style="list-style-type: none"> • Main board + daughter board • For 5 V, 3 V products
Daughter board for MB91107A/108/121	MB91907EB	<ul style="list-style-type: none"> • Connection to In Circuit Emulator (made by Fujitsu Microelectronics) • Combined use main board(MB91906EB)

*1: The header requires the NQPACK manufactured by Tokyo Eletech Co.
<Contact>TEL: 81-3-5295-1661

*2: The IC socket is mounted on the foot pattern on the user board..

*3 : The NQPACK and HQPACK can be used to hold and cover a chip, respectively.

*4: A ROM alternate unit is used connecting with a CPU bus. In the case of use, it is necessary to design so that ROM alternate unit can be connected on target board

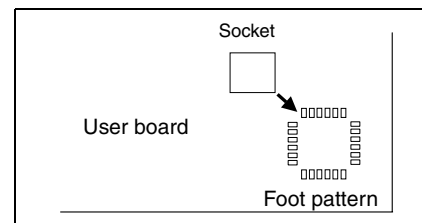

For MB91121

In Circuit Emulator (made by Fujitsu Microelectronics)

- Standard tool

Name	Part number	Note
Evaluation device	MB91V121CR-ES	<ul style="list-style-type: none"> • PGA135, DSU2
Emulator main unit for FR (DSU2/3)	MB2197-01	<ul style="list-style-type: none"> • The systems development support tool which used MCU for evaluating FR and builds in DSU interface. • Power supply voltage: AC100V or AC200 V • Dimensions: 210 mm (width) × 297 mm (depth) × 87 mm (height) • Weight: 2.7 kg • With MB2197-10 (DSU2/3 cable)
Adapter (LQFP-120)	MB2197-103	<ul style="list-style-type: none"> • Adapter unit to connect the user system using an LQFP120. • NQPACK120SD and HQPACK120SD are bundled *1 • MB91V108 is required separately

- Option tool

Name	Part number	Note
ROM alternate unit *4	MB2197-90 (with 100-V AC adapter)	<ul style="list-style-type: none"> • Memory board: Capable of substituting the memory on the target board • Memory size: 4 Mbytes • Data bus size: Selectable from among 8, 16, and 32-bit configurations • Write protect function

- Option

Name	Part number	Note
DSU2/3 cable	MB2197-10	Used to connect the emulator main unit to the adaptor unit or the adapter board.

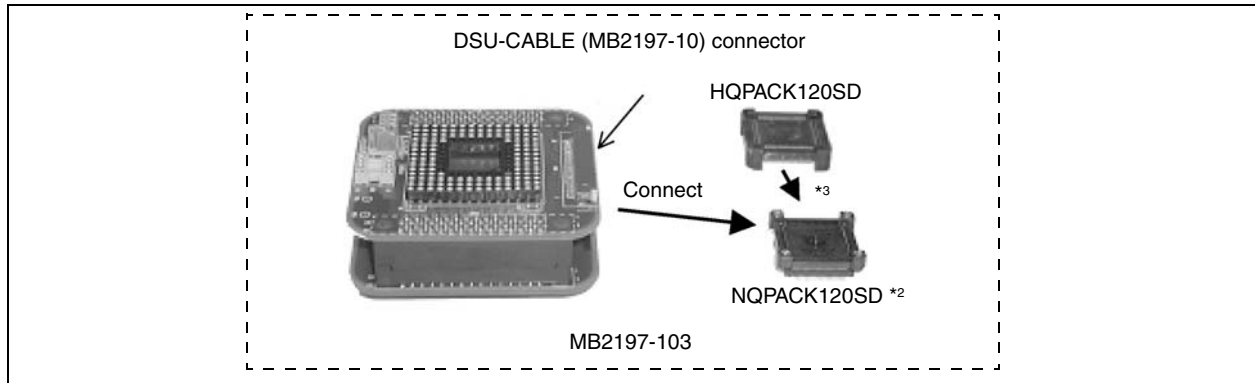

Evaluation board

Name	Part number	Note
Evaluation board (Main board)	MB91906EB	<ul style="list-style-type: none"> • Main board + daughter board • For 5 V, 3 V products
Daughter board for MB91107A/108/121	MB91907EB	<ul style="list-style-type: none"> • Connection to In Circuit Emulator (made by Fujitsu Microelectronics) • Combined use main board (MB91906EB)

*1: The header requires the NQPACK manufactured by Tokyo Eletech Co.
<Contact>TEL: 81-3-5295-1661

*2: The IC socket is mounted on the foot pattern on the user board.

*3 : The NQPACK and HQPACK can be used to hold and cover a chip, respectively.

*4 : A ROM alternate unit is used connecting with a CPU bus. In the case of use, it is necessary to design so that ROM alternate unit can be connected on target board.

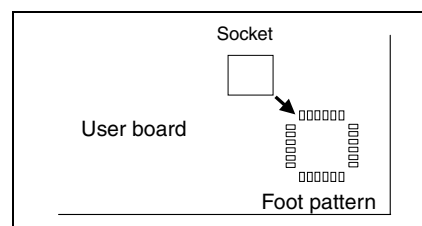

32-bit FR Family Support Tools

For MB91F127/128

In Circuit Emulator (made by Fujitsu Microelectronics)

- Standard tool

Name	Part number	Note
Evaluation device	MB91FV129CR-ES	• PGA299, DSU3
Emulator main unit for FR (DSU3/4)	MB2198-01	<ul style="list-style-type: none"> • The systems development support tool which used MCU for evaluating FR and builds in DSU interface • Power supply voltage: AC100 V or AC200 V • Dimensions: 150 mm (width) × 210 mm (depth) × 46 mm (height) • Weight: 2.7 kg • MB2198-10 (DSU3/4 cable) is required separately
DSU3/4 cable	MB2198-10	Used to connect the MB2198-01 to the adapter board
PGA299P adapter board type 3 for MB91FV129	MB2197-160	<ul style="list-style-type: none"> • User alternate memory: 4 MB • Header cable is bundled • MB91FV129 is required separately
LQFP-100Header board	MB2197-162	<ul style="list-style-type: none"> • Used to connect the adapter board to the user board • NQPACK100SD-ND and HQPACK100SD *1 are bundled

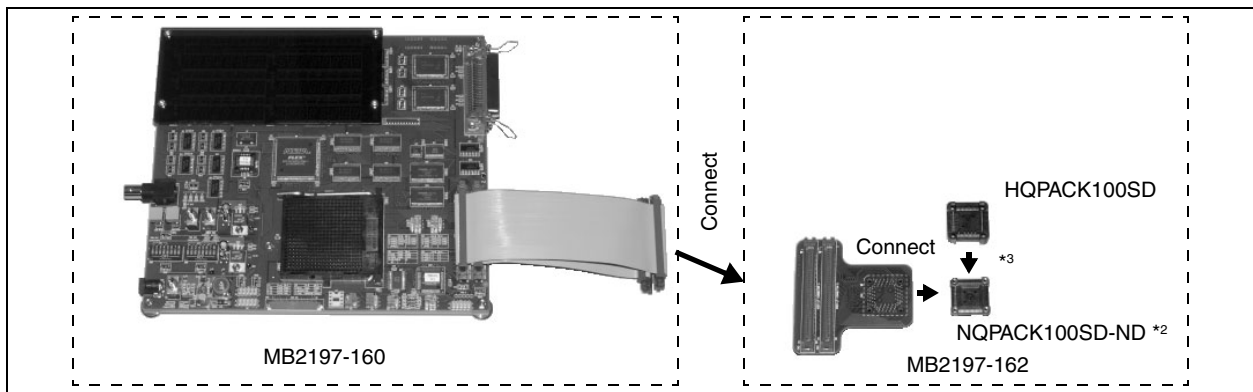

Evaluation board

Name	Part number	Note
Evaluation board (Main board)	MB91906EB	<ul style="list-style-type: none"> • Main board + daughter board • For 5 V, 3 V products
Daughter board for MB91106A/109	MB91910EB	Used to connect the adapter to the In Circuit Emulator (made by Fujitsu Microelectronics)

Programmer for Flash microcontroller

- Parallel programmer

Product name	Package (lead pitch, body size)	Package code	Adapter unit	
			Flash Support Group, Inc. *4	MINATO ELECTRONICS INC. *5
MB91F127PFV MB91F128PFV	LQFP-100 (0.5 mm, □14 × 14 mm)	FPT-100P-M05	TE110-123F14AP	—

- Serial programmer

Product name	Serial programmer
	Yokogawa Digital Computer Corporation *6
MB91F127PFV MB91F128PFV	NETIMPRESS

*1 : The header requires the NQPACK manufactured by Tokyo Eletech Co.
 <Contact>TEL: 81-3-5295-1661

*2 : The IC socket is mounted on the foot pattern on the user board.

*3 : The NQPACK and HQPACK can be used to hold and cover a chip, respectively.

*4 : Flash Support Group, Inc.
 <Contact> TEL : 053-428-8383
<http://www.j-fsg.co.jp/e/top.html>

*5 : MINATO ELECTRONICS INC.
 <Contact> TEL : 045-591-5611, FAX : 045-592-2854
http://www.minato.co.jp/index_e.asp

*6 : Yokogawa Digital Computer Corporation
 <Contact> TEL : 042-333-6224 FAX : 042-352-6107
<http://www.yokogawa-digital.com/emb/en/index.html>

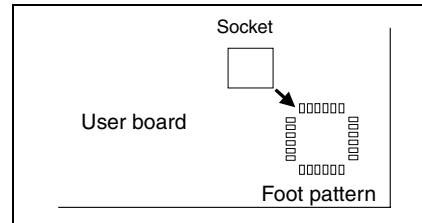

For MB91133, MB91F133A

In Circuit Emulator (made by Fujitsu Microelectronics)

• Standard tool

Name	Part number	Note
Evaluation device	MB91FV130CR-ES	• PGA299, DSU3
Emulator main unit for FR (DSU3/4)	MB2198-01	<ul style="list-style-type: none"> • The systems development support tool which used MCU for evaluating FR and builds in DSU interface • Power supply voltage: AC100V or AC200 V • Dimensions: 150 mm (width) × 210 mm (depth) × 46 mm (height) • Weight: 2.7 kg • MB2198-10 (DSU3/4 cable) is required separately
DSU3/4 cable	MB2198-10	Used to connect the MB2198-01 to the adapter board.
PGA299P evaluation board type 2 for FR-DSU3	MB2197-130	<ul style="list-style-type: none"> • Connection to MB2197-10. Combined use MB2197-135. • Header cable is bundled • MB91FV130 is required separately
LQFP-144 Header type 2	MB2197-135	<ul style="list-style-type: none"> • Used to connect the evaluation board to the user board • NQPACK144SD-ND and HQPACK144SD are bundled *1

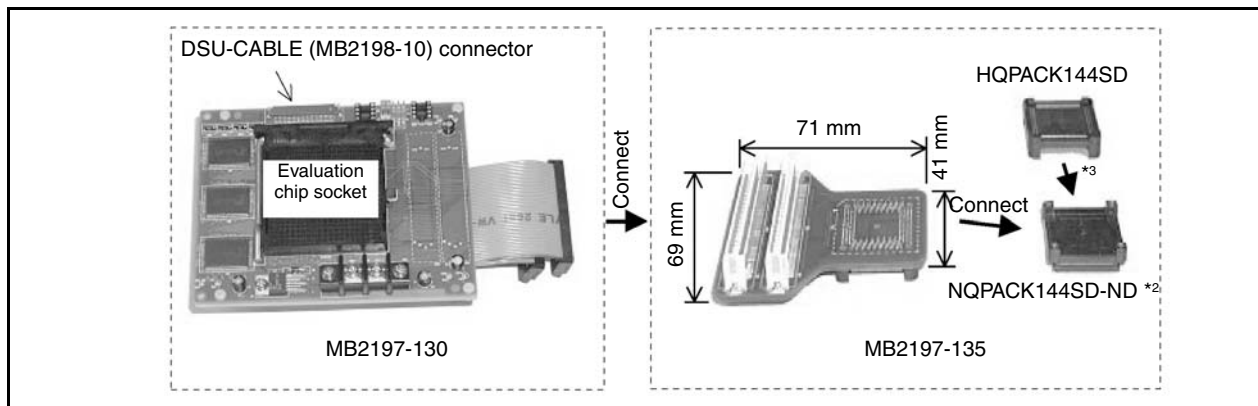

• Option tool

Name	Part number	Note
ROM alternate unit *4	MB2197-90 (with 100-V AC adapter)	<ul style="list-style-type: none"> • Memory board: Capable of substituting the memory on the target board • Memory size: 4 Mbytes • Data bus size: Selectable from among 8, 16, and 32-bit configurations • Write protect function

32-bit FR Family Support Tools

Evaluation board

Name	Part number	Note
Evaluation board (Main board)	MB91906EB	<ul style="list-style-type: none"> Main board + daughter board For 5 V, 3 V products
Evaluation board for MB91130 series	MB91908EB	It can be used only.

Programmer for Flash microcontroller

• Parallel programmer

Product name	Package (lead pitch, body size)	Package code	Adapter unit	
			Flash Support Group, Inc. *5	MINATO ELECTRONICS INC.*6
MB91F133APMT2	LQFP-144 (0.5 mm, □20 × 20 mm)	FPT-144P-M08	—	MF00-871 (for MODEL1893/1931) MF05-871 (for MODEL1940)
MB91F133APBT	BGA-144 (0.8 mm, □12 × 12 mm)	BGA-144P-M01	—	MF00-870 (for MODEL1893/1931) MF05-870 (for MODEL1940)

• Serial programmer

Product name	Serial programmer
	Yokogawa Digital Computer Corporation*7
MB91F133APMT2 MB91F133APBT	NETIMPRESS

*1: The header requires the NQPACK manufactured by Tokyo Eletech Co.
<Contact>TEL: 81-3-5295-1661

*2: The IC socket is mounted on the foot pattern on the user board.

*3: The NQPACK and HQPACK can be used to hold and cover a chip, respectively.

*4: A ROM alternate unit is used connecting with a CPU bus. In the case of use, it is necessary to design so that ROM alternate unit can be connected on target board.

*5: Flash Support Group, Inc.
<Contact> TEL : 053-428-8383
<http://www.j-fsg.co.jp/e/top.html>

*6: MINATO ELECTRONICS INC.
<Contact> TEL : 045-591-5611, FAX : 045-592-2854
http://www.minato.co.jp/index_e.asp

*7: Yokogawa Digital Computer Corporation
<Contact> TEL: 042-333-6224 FAX : 042-352-6107
<http://www.yokogawa-digital.com/emb/en/index.html>

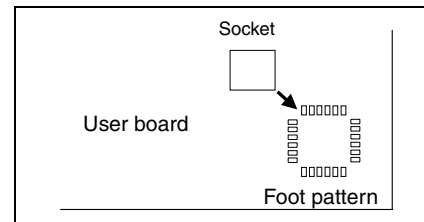

For MB91151A/154/155/F155A/F158

In Circuit Emulator (made by Fujitsu Microelectronics)

- Standard tool

Name	Part number	Note
Evaluation device	MB91V151ACR-ES MB91FV150CR-ES	<ul style="list-style-type: none"> • PGA299, DSU3
Emulator main unit for FR (DSU3/4)	MB2198-01	<ul style="list-style-type: none"> • The systems development support tool which used MCU for evaluating FR and builds in DSU interface. • Power supply voltage: AC100 V or AC200 V • Dimensions: 150 mm (width) × 210 mm (depth) × 46 mm (height) • Weight: 2.7 kg • MB2198-10 (DSU3/4 cable) is required separately
DSU3/4 cable	MB2198-10	Used to connect the MB2198-01 to the adapter board.
Adapter unit	MB2197-150	<ul style="list-style-type: none"> • Connection to MB2198-10 • Capable of real-time display of internal RAM (6 points) • Built-in function for measuring two-point execution time • Combined use MB2197-155

- Header

Name	Part number	Note
Header for MB91151A, MB91154, MB91155, MB91F155A (LQFP-144)	MB2197-155	<ul style="list-style-type: none"> • Used to connect the adapter board to the user board. • NQPACK144SD-ND and HQPACK144SD are bundled *1
Header for MB91F158 (LQFP-120)	MB2197-153	<ul style="list-style-type: none"> • Used to connect the adapter board to the user board. • NQPACK120SE and HQPACK120SE are bundled *1

- Evaluation device

Name	Part number	Note
Evaluation device for MB91151A	MB91V151ACR-ES	For MB91151A
Evaluation device for MB91154, MB91155, MB91F155A, MB91F158	MB91FV150CR-ES	For MB91154, MB91155, MB91F155A and MB91F158

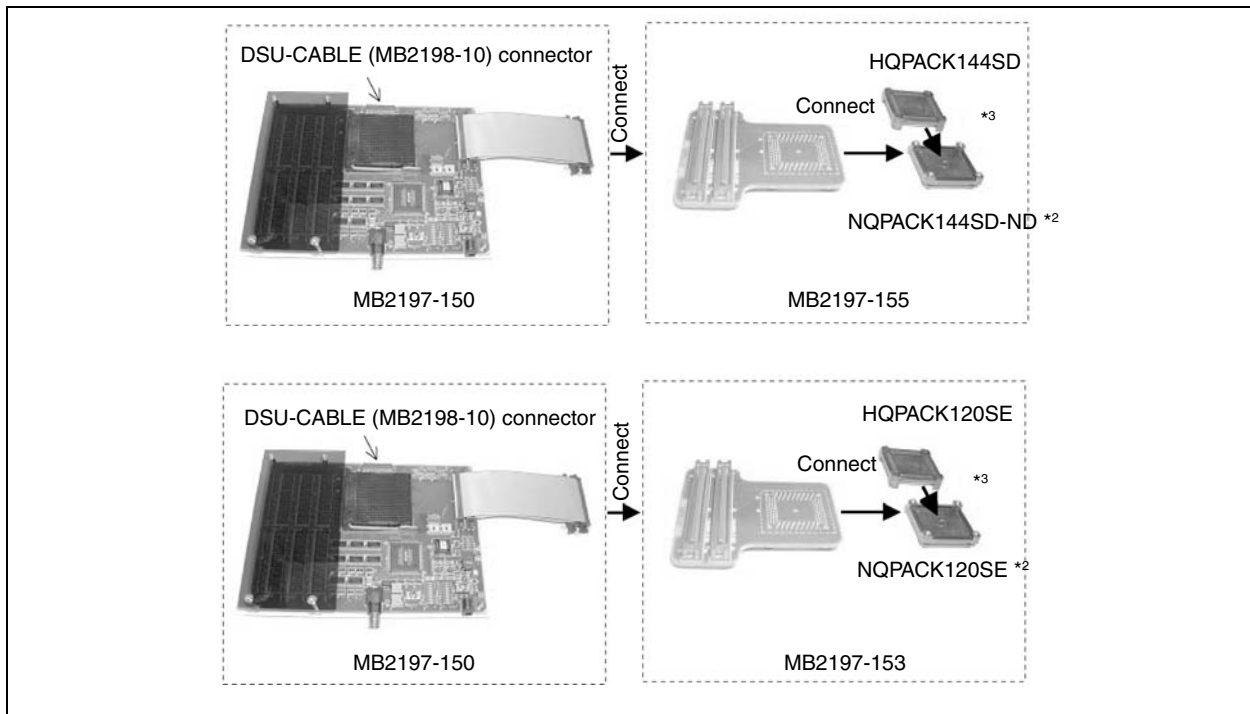

32-bit FR Family Support Tools

• Option

Name	Part number	Note
ROM alternate unit *4	MB2197-90 (with 100-V AC adapter)	<ul style="list-style-type: none"> • Memory board: Capable of substituting the memory on the target board • Memory size: 4 Mbytes • Data bus size: Selectable from among 8, 16, and 32-bit configurations • Write protect function

Evaluation board

Name	Part number	Note
Evaluation board	MB91906EB	<ul style="list-style-type: none"> • Main board + daughter board • FlashROM, DRAM, etc. Built-in • AC100 V, ACAdapter is bundled.
Evaluation board for MB91150 series	MB91911EB	It can be used only.

Programmer for Flash microcontroller

• Parallel programmer

Product name	Package (lead pitch, body size)	Package code	Adapter unit	
			Flash Support Group, Inc. *5	MINATO ELECTRONICS INC.*6
MB91F155APFV-G	LQFP-144 (0.5 mm, □20 × 20 mm)	FPT-144P-M08	TE110-155F10AP	MF05-1003 (for MODEL1940) MF13-1003A (for MODEL1893/1931)
MB91F158PFF-G	LQFP-120 (0.4 mm, □14 × 14 mm)	FPT-120P-M05	-	MF05-1271 (for MODEL1940) MF13-1271 (for MODEL1893/1931)

• Serial programmer

Product name	Serial programmer
	Yokogawa Digital Computer Corporation*7
MB91F155APFV	NETIMPRESS

*1: The header requires the NQPACK manufactured by Tokyo Eletech Co.
<Contact>TEL: 81-3-5295-1661

*2: The IC socket is mounted on the foot pattern on the user board.

*3 : The NQPACK and HQPACK can be used to hold and cover a chip, respectively.

*4 : A ROM alternate unit is used connecting with a CPU bus. In the case of use, it is necessary to design so that ROM alternate unit can be connected on target board.

*5 : Flash Support Group, Inc.
<Contact> TEL : 053-428-8383
<http://www.j-fsg.co.jp/e/top.html>

*6 : MINATO ELECTRONICS INC.
<Contact> TEL : 045-591-5611, FAX : 045-592-2854
http://www.minato.co.jp/index_e.asp

*7 : Yokogawa Digital Computer Corporation
<Contact> TEL: 042-333-6224 FAX : 042-352-6107
<http://www.yokogawa-digital.com/emb/en/index.html>

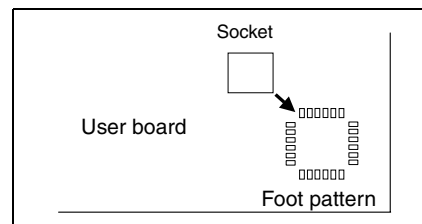

For MB91210 series

In Circuit Emulator (made by Fujitsu Microelectronics)

- Standard tool

Name	Part number	Note
Evaluation device	MB91V210PB-ESE1	• PGA420, DSU4
Emulator main unit for FR (DSU4)	MB2198-01	<ul style="list-style-type: none"> • The systems development support tool which used MCU for evaluating FR and builds in DSU interface. • Power supply voltage: AC100V or AC200 V • Dimensions: 150 mm (width) × 210 mm (depth) × 46 mm (height) • Weight: 0.7 kg
Adapter board (PGA-420)	MB2198-140	• Header I/F cable is bundled
Header (LQFP-144)	MB2198-141	• Used to connect the adapter board to the user board
Header (LQFP-100)	MB2198-142	• Used to connect the adapter board to the user board

Programmer for Flash microcontroller

- Parallel programme

Product name	Package (lead pitch, body size)	Package code	Adapter unit	
			Flash Support Group, Inc. ^{**}	MINATO ELECTRONICS INC. ^{**5}
MB91F211B	LQFP-100 (0.5mm, 14 × 14mm)	FPT-100P-M20	Under development	-
MB91F213A	LQFP-144 (0.5mm, 20 × 20mm)	FPT-144P-M08	TEF110-91F213	-

For MB91220 series

In Circuit Emulator (made by Fujitsu Microelectronics)

- Standard tool

Name	Part number	Note
Evaluation device	MB91V220CR-ES	• PGA401, DSU4
Emulator main unit for FR (DSU4)	MB2198-01	<ul style="list-style-type: none"> • The systems development support tool which used MCU for evaluating FR and builds in DSU interface. • Power supply voltage: AC100V or AC200 V • Dimensions: 150 mm (width) × 210 mm (depth) × 46 mm (height) • Weight: 0.7 kg
Adapter board (PGA-401)	MB2198-130	• Header I/F cable is bundled
Header (LQFP-144)	MB2198-132	• Used to connect the adapter board to the user board

Programmer for Flash microcontroller

- Parallel programme

Product name	Package (lead pitch, body size)	Package code	Adapter unit	
			Flash Support Group, Inc. ^{**}	MINATO ELECTRONICS INC. ^{**5}
MB91F223 MB91F223S	LQFP-144 (0.5mm, 20 × 20mm)	FPT-144P-M08	TEF110-248F42AP	-

32-bit FR Family Support Tools

For MB91230 series

In Circuit Emulator (made by Fujitsu Microelectronics)

- Standard tool

Name	Part number	Note
Evaluation device	MB91V230CR-ES	• PGA401, DSU4
Emulator main unit for FR (DSU4)	MB2198-01	<ul style="list-style-type: none"> • The systems development support tool which used MCU for evaluating FR and builds in DSU interface. • Power supply voltage: AC100V or AC200 V • Dimensions: 150 mm (width) × 210 mm (depth) × 46 mm (height) • Weight: 0.7 kg
Adapter board (PGA-401)	MB2198-130	• Header I/F cable is bundled
Header (LQFP-120)	MB2198-121	<ul style="list-style-type: none"> • Used to connect the adapter board to the user board • HQPACK120SE and NQPACK120SE are bundled *1

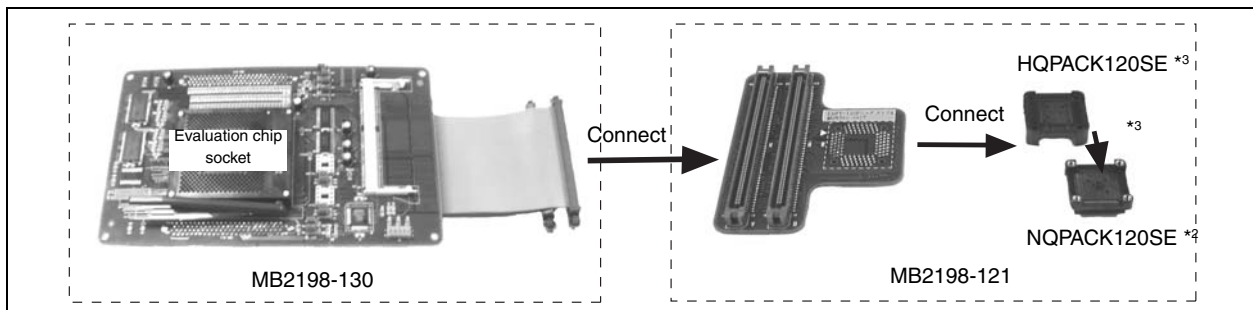

Programmer for Flash microcontroller

- Parallel programme

Product name	Package (lead pitch, body size)	Package code	Adapter unit	
			Flash Support Group, Inc. *4	MINATO ELECTRONICS INC. *5
MB91F233A MB91F233L	LQFP-120 (0.4 mm, □14 × 14 mm)	FPT-120P-M05	TEF110-233F20AP	MF13-1330 (for MODEL1893/1931)
MB91F233L	FLGA-128 (0.65 mm, □9 × 9 mm)	LGA-128P-M01	TEF110-233F24AP	-

- Serial programmer

Product name	Serial programmer
	Yokogawa Digital Computer Corporation *6
MB91F233A MB91F233L	NETIMPRESS

Evaluation board

Name	Part number	Note
Evaluation board for MB91F233	MB91920EB	It can be used only.

*1: The header requires the NQPACK manufactured by Tokyo Eletech Co.

<Contact> TEL : 81-3-5295-1661

*2: The IC socket is mounted on the foot pattern on the user board.

*3: The NQPACK and HQPACK can be used to hold and cover a chip, respectively.

*4: Flash Support Group, Inc.

<Contact> TEL : 053-428-8383
<http://www.j-fsg.co.jp/e/top.html>

*5: MINATO ELECTRONICS INC.

<Contact> TEL : 045-591-5611, FAX : 045-592-2854
http://www.minato.co.jp/index_e.asp

*6: Yokogawa Digital Computer Corporation

<Contact> TEL: 042-333-6224 FAX : 042-352-6107
<http://www.yokogawa-digital.com/emb/en/index.html>

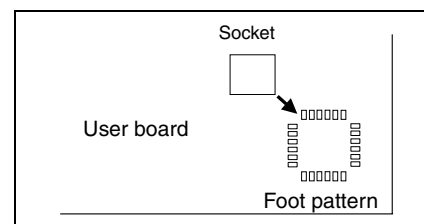

For MB91245 series

In Circuit Emulator (made by Fujitsu Microelectronics)

- Standard tool

Name	Part number	Note
Evaluation device	MB91V245ACR-ES	• PGA401, DSU4
Emulator main unit for FR (DSU3/4)	MB2198-01	<ul style="list-style-type: none"> • The systems development support tool which used MCU for evaluating FR and builds in DSU interface. • Power supply voltage: AC100 V or AC200 V • Dimensions: 150 mm (width) × 210 mm (depth) × 46 mm (height) • Weight: 0.7 kg
Adapter board	MB2198-130	• Header I/F cable is bundled
header board	MB2198-123	<ul style="list-style-type: none"> • Adapter unit to connect the user system • NQPACK144SD-ND and HQPACK144SD are bundled *1

Programmer for Flash microcontroller

- Parallel programmer

Product name	Package (lead pitch, body size)	Package code	Adapter unit
			Flash Support Group, Inc. *2
MB91F248	LQFP-144 (0.5 mm, □20 × 20 mm)	FPT-144P-M08	TEF110-248F42AP
MB91F248S			

*1: The header requires the NQPACK manufactured by Tokyo Eletech Co.

<Contact>TEL: 81-3-5295-1661

The IC socket is mounted on the foot pattern on the user board.

The NQPACK and HQPACK can be used to hold and cover a chip, respectively.

*2 : Flash Support Group, Inc.

<Contact> TEL : 053-428-8383

<http://www.j-fsg.co.jp/e/top.html>

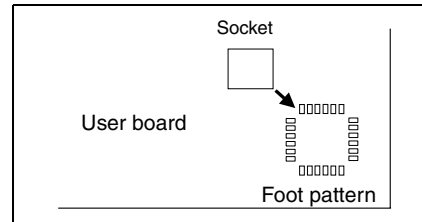

32-bit FR Family Support Tools

For MB91260B series

In Circuit Emulator (made by Fujitsu Microelectronics)

- Standard tool

Name	Part number	Note
Evaluation device	MB91V260BCR-ES	• PGA401, DSU4
Emulator main unit for FR (DSU4)	MB2198-01	<ul style="list-style-type: none"> • The systems development support tool which used MCU for evaluating FR and builds in DSU interface. • Power supply voltage: AC100 V or AC200 V • Dimensions: 150 mm (width) × 210 mm (depth) × 46 mm (height) • Weight: 0.7 kg
Adapter board	MB2198-130	• Header I/F cable is bundled
header board (QFP-100)	MB2198-122	<ul style="list-style-type: none"> • Adapter unit to connect the user system • NQPACK100RB179-A and HQPACK100RB179 are bundled *1
header board (LQFP-100)	MB2198-126	<ul style="list-style-type: none"> • Adapter unit to connect the user system • NQPACK100SD-ND and HQPACK100SD are bundled *1

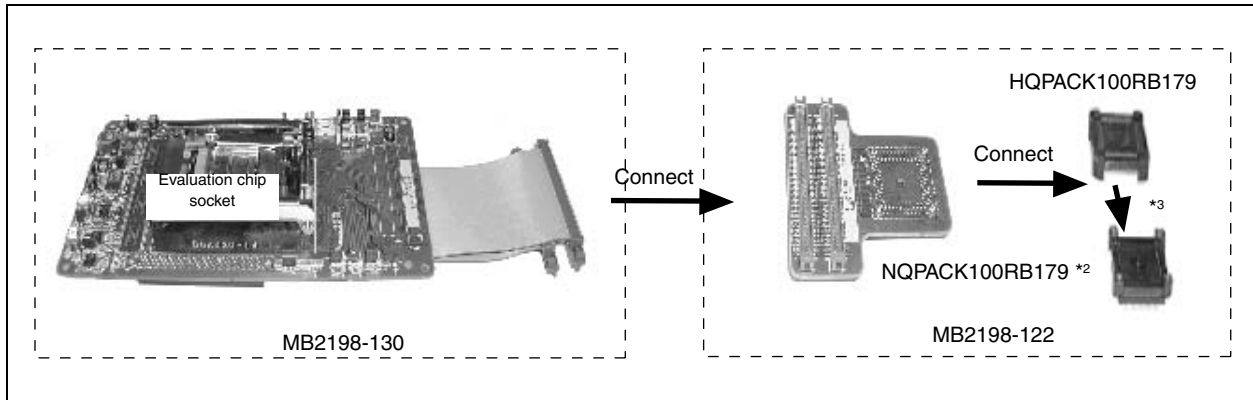

Programmer for Flash microcontroller

- Parallel programmer

Product name	Package (lead pitch, body size)	Package code	Adapter unit	
			Flash Support Group, Inc. *4	MINATO ELECTRONICS INC. *5
MB91F264BPF-GE1	QFP-100 (0.65 mm, □14 × 20 mm)	FPT-100P-M06	TEF110-264F21AP	MF13-1427 (for MODEL1893/1931)
MB91F264BPFV-GE1	LQFP-100 (0.5 mm, □14 × 14 mm)	FPT-100P-M05	Under development	MF13-1605 (for MODEL1893/1931)

- Serial programmer

Product name	Serial programmer	
	Yokogawa Digital Computer Corporation *6	Flash Support Group, Inc.
MB91F264B	NETIMPRESS	AF9101

Evaluation board

Name	Part number	Note
Evaluation board for MB91F264B	MB91921EB	It can be used only.

*1: The header requires the NQPACK manufactured by Tokyo Eletech Co.
<Contact>TEL: 81-3-5295-1661

*2: The IC socket is mounted on the foot pattern on the user board.

*3 : The NQPACK and HQPACK can be used to hold and cover a chip, respectively.

*4 : Flash Support Group, Inc.

<Contact> TEL : 053-428-8383
<http://www.j-fsg.co.jp/e/top.html>

*5 : MINATO ELECTRONICS INC.

<Contact> TEL : 045-591-5611, FAX : 045-592-2854
http://www.minato.co.jp/index_e.asp

*6 : Yokogawa Digital Computer Corporation

<Contact> TEL: 042-333-6224 FAX : 042-352-6107
<http://www.yokogawa-digital.com/emb/en/index.html>

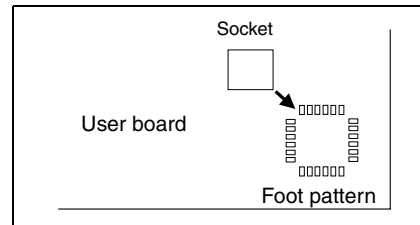

32-bit FR Family Support Tools

For MB91265A series

In Circuit Emulator (made by Fujitsu Microelectronics)

- Standard tool

Name	Part number	Note
Evaluation device	MB91V265ACR-ES	• PGA401, DSU4
Emulator main unit for FR (DSU4)	MB2198-01	• The systems development support tool which used MCU for evaluating FR and builds in DSU interface. • Power supply voltage: AC100 V or AC200 V • Dimensions: 150 mm (width) × 210 mm (depth) × 46 mm (height) Weight: 0.7 kg
Adapter board	MB2198-130	• Header I/F cable is bundled
header board (LQFP-64)	MB2198-128	• Adapter unit to connect the user system • NQPACK064SB and HQPACK064SB140 are bundled *1

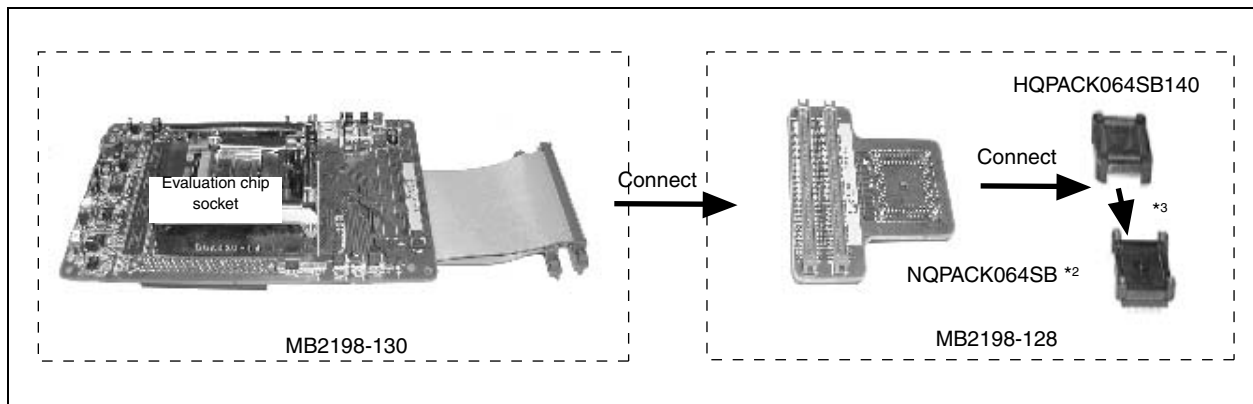

Programmer for Flash microcontroller

- Parallel programmer

Product name	Package (lead pitch, body size)	Package code	Adapter unit	
			Flash Support Group, Inc. *4	MINATO ELECTRONICS INC. *5
MB91F267A MB91F267NA	LQFP-64 (0.65 mm, □12 × 12 mm)	FPT-64P-M23	Under development	MF13-1605 (for MODEL1893/1931)

- Serial programmer

Product name	Serial programmer
MB91F267A MB91F267NA	Under planning

*1: The header requires the NQPACK manufactured by Tokyo Eletech Co.
<Contact>TEL: 81-3-5295-1661

*2: The IC socket is mounted on the foot pattern on the user board.

*3: The NQPACK and HQPACK can be used to hold and cover a chip, respectively.

*4: Flash Support Group, Inc.

<Contact> TEL : 053-428-8383
<http://www.j-fsg.co.jp/e/top.html>

*5: MINATO ELECTRONICS INC.

<Contact> TEL : 045-591-5611, FAX : 045-592-2854
http://www.minato.co.jp/index_e.asp

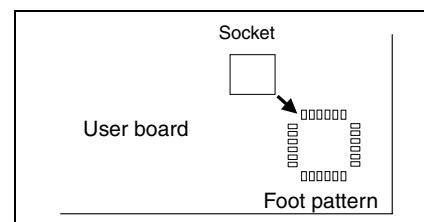

For MB91270 series

In Circuit Emulator (made by Fujitsu Microelectronics)

- Standard tool

Name	Part number	Note
Evaluation device	MB91V280CR-ES	• PGA401, DSU4
Emulator main unit for FR (DSU3/4)	MB2198-01	<ul style="list-style-type: none"> • The systems development support tool which used MCU for evaluating FR and builds in DSU interface. • Power supply voltage: AC100 V or AC200 V • Dimensions: 150 mm (width) × 210 mm (depth) × 46 mm (height) Weight: 0.7 kg
Adapter board	MB2198-130	• Header I/F cable is bundled
header board	MB2198-129	<ul style="list-style-type: none"> • Adapter unit to connect the user system • NQPACK100SD-ND and HQPACK100SD are bundled *1

Programmer for Flash microcontroller

- Parallel programmer

Product name	Package (lead pitch, body size)	Package code	Adapter unit
			Flash Support Group, Inc. *2
MB91F273 MB91F273S MB91F278 MB91F278S	LQFP-100 (0.5 mm, □14 × 14 mm)	FPT-100P-M05	TEF110-272F39AP

*1: The header requires the NQPACK manufactured by Tokyo Eletech Co.
 The IC socket is mounted on the foot pattern on the user board.
 The NQPACK and HQPACK can be used to hold and cover a chip, respectively.

*2 : Flash Support Group, Inc.
 <Contact> TEL : 053-428-8383
<http://www.j-fsg.co.jp/e/top.html>

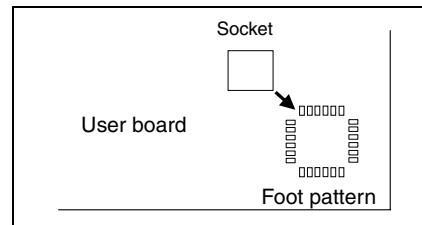

32-bit FR Family Support Tools

For MB91302A

In Circuit Emulator (made by Fujitsu Microelectronics)

- Standard tool

Name	Part number	Note
Evaluation device	MB91V301ACR-ES	• PGA179, DSU4
Emulator main unit for FR (DSU3/4)	MB2198-01	<ul style="list-style-type: none"> • The systems development support tool which used MCU for evaluating FR and builds in DSU interface. • Power supply voltage: AC100V or AC200 V • Dimensions: 150 mm (width) × 210 mm (depth) × 46 mm (height) • Weight: 2.7 kg • MB2198-10 (DSU3/4 cable) is required separately
DSU3/4 cable	MB2198-10	Used to connect the MB2198-01 to the adapter board.
Adapter board for MB91V301A	MB2198-100	• MB91V301A is required separately
Header board for LQFP-144	MB2198-101	<ul style="list-style-type: none"> • Header board connect to the user system using an LQFP-144 • NQPACK144SE and HQPACK144SE are bundled *1

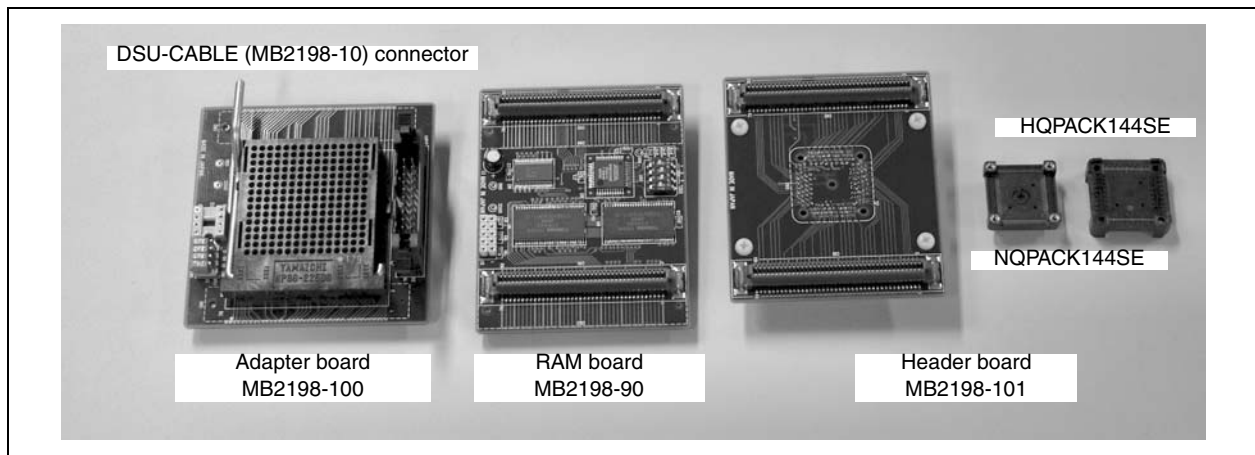

- Option tool

Name	Part number	Note
RAM board	MB2198-90	<ul style="list-style-type: none"> • Used to external ROM alternate memory • 32-bit bus: 4 MB, 16-bit bus: 2 MB
ROM alternate unit *4	MB2197-90 (with 100-V AC adapter)	<ul style="list-style-type: none"> • Memory board: Capable of substituting the memory on the target board • Memory size: 4 Mbytes • Data bus size: Selectable from among 8, 16, and 32-bit configurations • Write protect function

Evaluation board

Name	Part number	Note
Evaluation board	MB91906EB	<ul style="list-style-type: none"> • Main board + daughter board • FlashROM, DRAM, etc. Built-in • AC100 V, ACAadapter is bundled.
Evaluation board for MB91302A	MB91914EB	It can be used only.

*1: The header requires the NQPACK manufactured by Tokyo Eletech Co.
<Contact>TEL: 81-3-5295-1661

*2: The IC socket is mounted on the foot pattern on the user board.

*3 : The NQPACK and HQPACK can be used to hold and cover a chip, respectively.

*4 : A ROM alternate unit is used connecting with a CPU bus. In the case of use, it is necessary to design so that ROM alternate unit can be connected on target board.

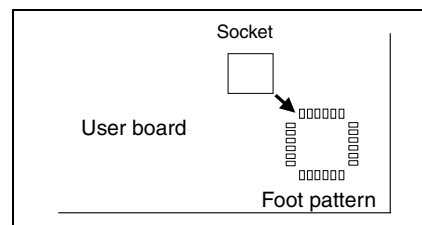

For MB91305

In Circuit Emulator (made by Fujitsu Microelectronics)

- Standard tool

Name	Part number	Note
Evaluation device	MB91305PMC-G-BNDE1	• LQFP-176, DSU4
Emulator main unit for FR (DSU3/4)	MB2198-01	<ul style="list-style-type: none"> • The systems development support tool which used MCU for evaluating FR and builds in DSU interface. • Power supply voltage: AC100V or AC200 V • Dimensions: 150 mm (width) × 210 mm (depth) × 46 mm (height) Weight: 2.7 kg • MB2198-10 (DSU3/4 cable) is required separately
DSU3/4 cable	MB2198-10	Used to connect the MB2198-01 to the target board.

Evaluation board

Name	Part number	Note
Evaluation board for MB91305	MB91925EB	It can be used only.

For MB91306R, MB91307B, MB91307R

In Circuit Emulator (made by Fujitsu Microelectronics)

- Standard tool

Name	Part number	Note
Evaluation device	MB91V307RCR-ES	• PGA135, DSU3
Emulator main unit for FR (DSU3/4)	MB2198-01	<ul style="list-style-type: none"> • The systems development support tool which used MCU for evaluating FR and builds in DSU interface. • Power supply voltage: AC100 V or AC200 V • Dimensions: 150 mm (width) × 210 mm (depth) × 46 mm (height) Weight: 2.7 kg • MB2198-10 (DSU3/4 cable) is required separately
DSU3/4 cable	MB2198-10	Used to connect the MB2198-01 to the adapter board.
DSU-FR emulator PGA-135PAdapter	MB2197-170A	—
DSU-FR emulator LQFP-120PHeader type 2	MB2197-172	<ul style="list-style-type: none"> • Header board connect to the user system using an LQFP-120 • NQPACK120SD and HQPACK120SD are bundled *1

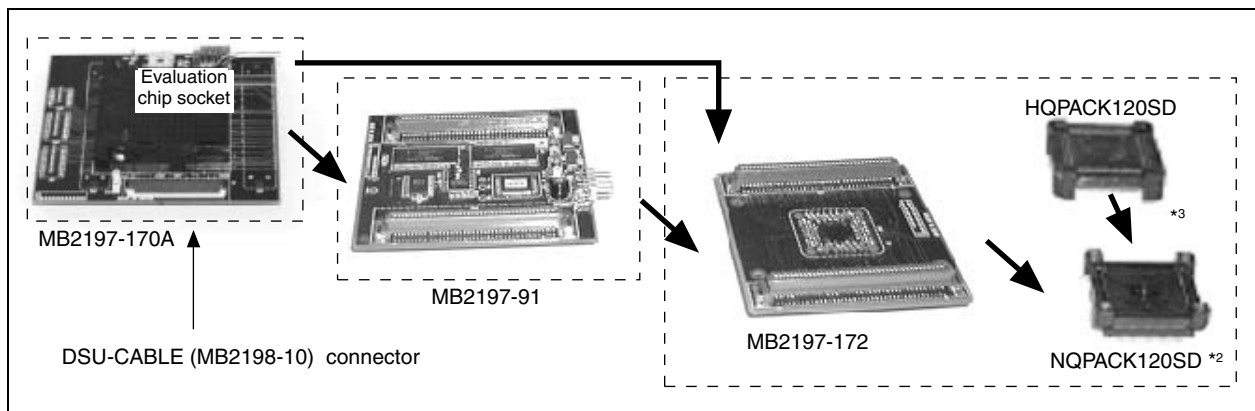

32-bit FR Family Support Tools

- Option tool

Name	Part number	Note
RAM board	MB2197-91	<ul style="list-style-type: none"> • Used to external ROM alternate memory • 32-bit bus: 4 MB, 16-bit bus: 2 MB
ROM alternate unit *4	MB2197-90 (with 100-V AC adapter)	<ul style="list-style-type: none"> • Memory board: Capable of substituting the memory on the target board • Memory size: 4 Mbytes • Data bus size: Selectable from among 8, 16, and 32-bit configurations • Write protect function

Evaluation board

Name	Part number	Note
Evaluation board	MB91906EB	<ul style="list-style-type: none"> • Main board + daughter board • FlashROM, DRAM, etc. Built-in • AC100 V, ACAdapter is bundled.
Evaluation board for MB91306/307	MB91915EB	It can be used only.

*1: The header requires the NQPACK manufactured by Tokyo Eletech Co.

<Contact>TEL: 81-3-5295-1661

*2: The IC socket is mounted on the foot pattern on the user board.

*3 : The NQPACK and HQPACK can be used to hold and cover a chip, respectively.

*4 : A ROM alternate unit is used connecting with a CPU bus. In the case of use, it is necessary to design so that ROM alternate unit can be connected on target board.

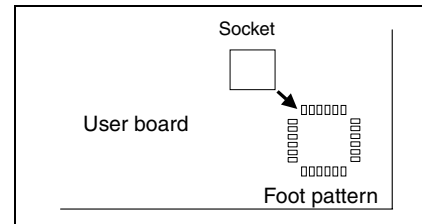

For MB91310

In Circuit Emulator (made by Fujitsu Microelectronics)

- Standard tool

Name	Part number	Note
Evaluation device	MB91FV310APFV-ESE1	• LQFP-144, DSU4
Emulator main unit for FR (DSU3/4)	MB2198-01	<ul style="list-style-type: none"> • The systems development support tool which used MCU for evaluating FR and builds in DSU interface. • Power supply voltage: AC100V or AC200 V • Dimensions: 150 mm (width) × 210 mm (depth) × 46 mm (height) • Weight: 2.7 kg • MB2198-10 (DSU3/4 cable) is required separately
DSU3/4 cable	MB2198-10	Used to connect the MB2198-01 to the target board.

Evaluation board

Name	Part number	Note
Evaluation board for MB91310	MB91918EB	It can be used only.

Programmer for Flash microcontroller

- Parallel programmer

Product name	Package (lead pitch, body size)	Package code	Adapter unit	
			Flash Support Group, Inc. *4	MINATO ELECTRONICS INC. *5
MB91F312A MB91FV310A	LQFP-144 (0.5 mm, □ 20 × 20 mm)	FPT-144P-M08	TEF110-264F21AP	MF00-1526 (for MODEL1893/1931)

- Serial programmer

Product name	Serial programmer
	Yokogawa Digital Computer Corporation *6
MB91F312A MB91FV310A	NETIMPRESS

For MB91313

In Circuit Emulator (made by Fujitsu Microelectronics)

- Standard tool

Name	Part number	Note
Evaluation device	MB91F313PMC-GE1	<ul style="list-style-type: none"> • LQFP-176, DSU4
Emulator main unit for FR (DSU3/4)	MB2198-01	<ul style="list-style-type: none"> • The systems development support tool which used MCU for evaluating FR and builds in DSU interface. • Power supply voltage: AC100V or AC200 V • Dimensions: 150 mm (width) × 210 mm (depth) × 46 mm (height) • Weight: 2.7 kg • MB2198-10 (DSU3/4 cable) is required separately
DSU3/4 cable	MB2198-10	Used to connect the MB2198-01 to the target board.

Programmer for Flash microcontroller

- Parallel programmer

Product name	Package (lead pitch, body size)	Package code	Adapter unit	
			Flash Support Group, Inc. *4	MINATO ELECTRONICS INC. *5
MB91F313	LQFP-176 (0.5 mm, □ 24 × 24 mm)	FPT-176P-M07	TRF110-91F313	—

For MB91314A

In Circuit Emulator (made by Fujitsu Microelectronics)

- Standard tool

Name	Part number	Note
Evaluation device	MB91F314PMC-GE1	<ul style="list-style-type: none"> • LQFP-120, DSU4
Emulator main unit for FR (DSU3/4)	MB2198-01	<ul style="list-style-type: none"> • The systems development support tool which used MCU for evaluating FR and builds in DSU interface. • Power supply voltage: AC100V or AC200 V • Dimensions: 150 mm (width) × 210 mm (depth) × 46 mm (height) • Weight: 2.7 kg • MB2198-10 (DSU3/4 cable) is required separately
DSU3/4 cable	MB2198-10	Used to connect the MB2198-01 to the target board.

Programmer for Flash microcontroller

- Parallel programmer

Product name	Package (lead pitch, body size)	Package code	Adapter unit	
			Flash Support Group, Inc. *4	MINATO ELECTRONICS INC. *5
MB91F314A	LQFP-120 (0.5 mm, □ 16 × 16 mm)	FPT-120P-M21	TRF110-91F313	—

32-bit FR Family Support Tools

For MB91319

In Circuit Emulator (made by Fujitsu Microelectronics)

- Standard tool

Name	Part number	Note
Evaluation device	MB91FV319APMT-ESE1	• LQFP-176, DSU4
Emulator main unit for FR (DSU3/4)	MB2198-01	<ul style="list-style-type: none"> • The systems development support tool which used MCU for evaluating FR and builds in DSU interface. • Power supply voltage: AC100V or AC200 V • Dimensions: 150 mm (width) × 210 mm (depth) × 46 mm (height) • Weight: 2.7 kg • MB2198-10 (DSU3/4 cable) is required separately
DSU3/4 cable	MB2198-10	Used to connect the MB2198-01 to the target board.

Programmer for Flash microcontroller

- Parallel programmer

Product name	Package (lead pitch, body size)	Package code	Adapter unit	
			Flash Support Group, Inc. *4	MINATO ELECTRONICS INC. *5
MB91FV319A	LQFP-176 (0.5 mm, □ 24 × 24 mm)	FPT-176P-M07	—	MF05-1695 (for MODEL1940)

- Serial programmer

Product name	Serial programmer
	Yokogawa Digital Computer Corporation *6
MB91FV319A	NETIMPRESS

For MB91345

In Circuit Emulator (made by Fujitsu Microelectronics)

- Standard tool

Name	Part number	Note
Evaluation device	MB91F345BPFT-GE1 MB91F346BPFT-GE1	• LQFP-100, DSU4
Emulator main unit for FR (DSU3/4)	MB2198-01	<ul style="list-style-type: none"> • The systems development support tool which used MCU for evaluating FR and builds in DSU interface. • Power supply voltage: AC100V or AC200 V • Dimensions: 150 mm (width) × 210 mm (depth) × 46 mm (height) • Weight: 2.7 kg • MB2198-10 (DSU3/4 cable) is required separately
DSU3/4 cable	MB2198-10	Used to connect the MB2198-01 to the target board.

- Serial programmer

Product name	Serial programmer
	Yokogawa Digital Computer Corporation *6
MB91F345B MB91F346B	NETIMPRESS

For MB91350A series

In Circuit Emulator (made by Fujitsu Microelectronics)

- Standard tool

Name	Part number	Note
Evaluation device	MB91V350APB-ES	<ul style="list-style-type: none"> • BGA420, DSU4
Emulator main unit for FR (DSU4)	MB2198-01	<ul style="list-style-type: none"> • The systems development support tool which used MCU for evaluating FR and builds in DSU interface. • Power supply voltage: AC100 V or AC200 V • Dimensions: 150 mm (width) × 210 mm (depth) × 46 mm (height) • Weight: 0.7 kg
Adapter board for MB91350A	MB2198-110	<ul style="list-style-type: none"> • Header I/F cable is bundled • Built-in emulation memory

- Header

Name	Part number	Note
Header for MB91352A/ MB91353A/MB91F353A (LQFP-120)	MB2198-112	<ul style="list-style-type: none"> • Used to connect the adapter board to the user board. • NQPACK120SD and HQPACK120SD are bundled *1
Header for MB91354A/ MB91355A/MB91F355A (LQFP-176)	MB2198-111	<ul style="list-style-type: none"> • Used to connect the adapter board to the user board • HQPACK176SD and NQPACK176SD are bundled *1

Programmer for Flash microcontroller

- Parallel programmer

Product name	Package (lead pitch, body size)	Package code	Adapter unit	
			Flash Support Group, Inc. *4	MINATO ELECTRONICS INC. *5
MB91F353A	LQFP-120 (0.5mm, □16 × 16 mm)	FPT-120P-M21	TEF110-353F18AP	Under development
MB91F355A	LQFP-176 (0.5 mm, □24 × 24 mm)	FPT-176P-M02	TEF110-355F19AP	MF13-1361 (for MODEL1893/1931)

- Serial programmer

FR Family	Serial programmer
	Yokogawa Digital Computer Corporation *6
MB91F353A MB91F355A	NETIMPRESS

32-bit FR Family Support Tools

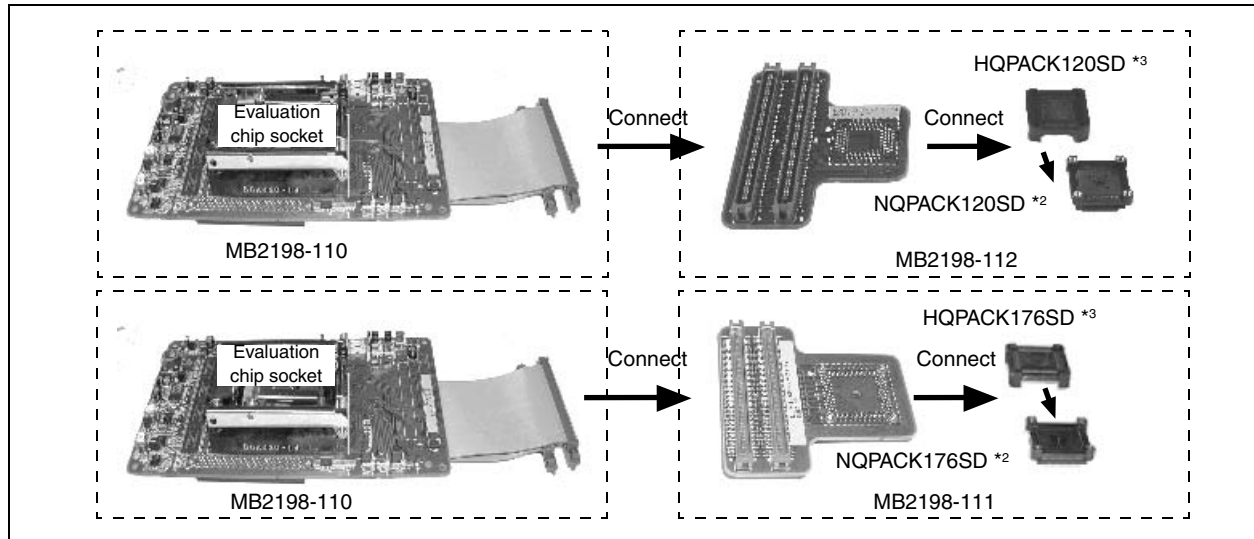

Evaluation board

• Main board

Name	Part number	Note
Evaluation board (Main board)	MB91906EB	<ul style="list-style-type: none"> Main board + daughter board For 5 V, 3 V products

• Daughter board

Name	Part number	Note
Daughter board for MB91F353A	MB91922EB	Combined use main board (MB91906EB)
Daughter board for MB91F355A	MB91916EB	Combined use main board (MB91906EB)

*1: The header requires the NQPACK manufactured by Tokyo Eletech Co.

<Contact>TEL: 81-3-5295-1661

*2: The IC socket is mounted on the foot pattern on the user board.

*3 : The NQPACK and HQPACK can be used to hold and cover a chip, respectively.

*4 : Flash Support Group, Inc.

<Contact> TEL : 053-428-8383

<http://www.j-fsg.co.jp/e/top.html>

*5 : MINATO ELECTRONICS INC.

<Contact> TEL : 045-591-5611, FAX : 045-592-2854

http://www.minato.co.jp/index_e.asp

*6 : Yokogawa Digital Computer Corporation

<Contact> TEL: 042-333-6224 FAX : 042-352-6107

<http://www.yokogawa-digital.com/emb/en/index.html>

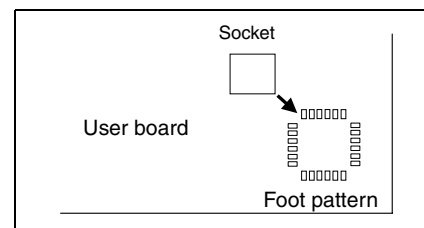

For MB91360 series

In Circuit Emulator (made by Fujitsu Microelectronics)

- Standard tool

Name	Part number	Note
Evaluation device	MB91FV360GACR-ES	• PGA401, DSU3
Emulator main unit for FR (DSU3/4)	MB2198-01	<ul style="list-style-type: none"> • The systems development support tool which used MCU for evaluating FR and builds in DSU interface. • Power supply voltage: AC100 V or AC200 V • Dimensions: 150 mm (width) × 210 mm (depth) × 46 mm (height) • Weight: 2.7 kg • MB2198-10 (DSU3/4 cable) is required separately
DSU3/4 cable	MB2198-10	Used to connect the MB2198-01 to the adapter board
PGA401P Adapter board for MB91360	MB2197-120	• Built-in external trace for evaluation device and user overlay memory

- Header board

Name	Part number	Note
Header board L for MB91F36xGB (LQFP120)	MB919360-120L	<ul style="list-style-type: none"> • FPT-120P-M21 header board. Connection to user board. • NQPACK120SD and HQPACK120SD are required separately *1
Header board H for MB91F36xGB (LQFP120)	MB919360-120H	<ul style="list-style-type: none"> • FPT-120P-M21 header board. Connection to user board. • NQPACK120SD and HQPACK120SD are required separately *1
Header board for MB91F369GA (QFP160)	MB919360-160	<ul style="list-style-type: none"> • FPT-160P-M15 header board. Connection to user board • NQPACK160SD and HQPACK160SD are required separately
Header board for MB91F362GA (QFP208)	MB2197-127	<ul style="list-style-type: none"> • FPT-208P-M04 header board. Connection to user board. • NQPACK208SD and HQPACK208SD are bundled *1

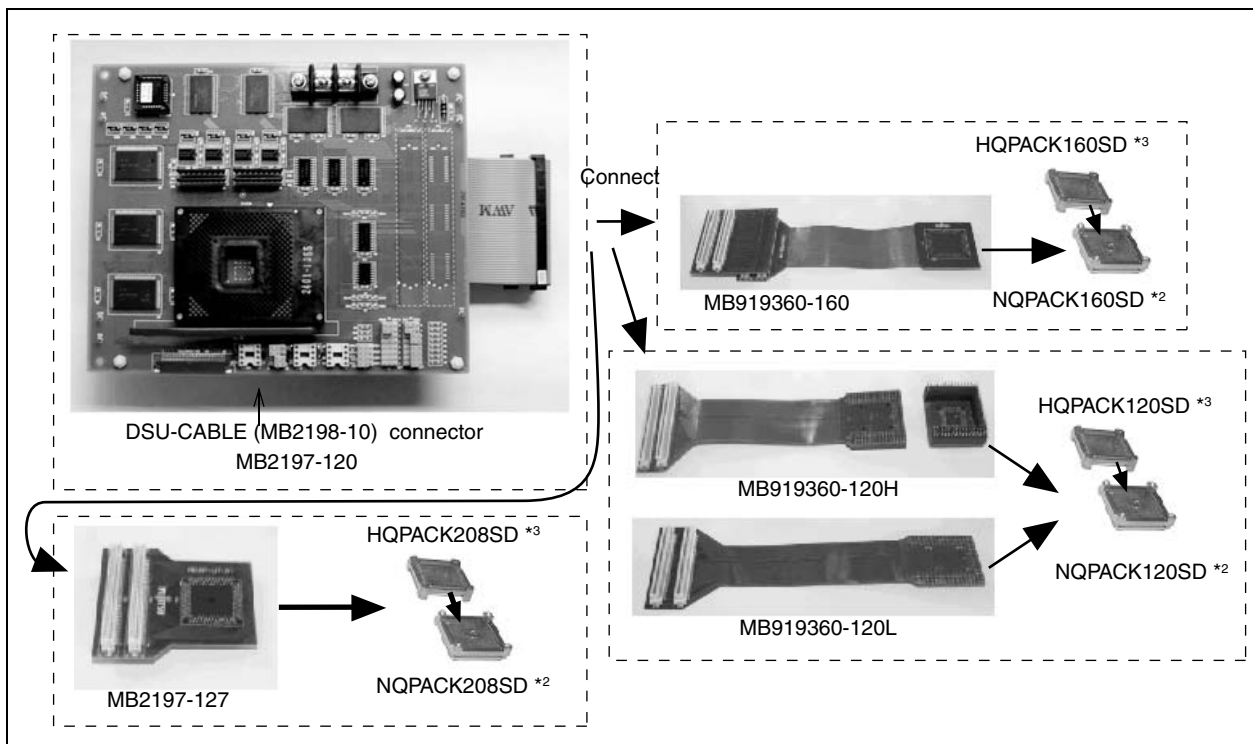

32-bit FR Family Support Tools

• Option tool

Name	Part number	Note
ROM alternate unit *4	MB2197-90 (with 100-V AC adapter)	<ul style="list-style-type: none"> Memory board: Capable of substituting the memory on the target board Memory size: 4 Mbytes Data bus size: Selectable from among 8, 16, and 32-bit configurations Write protect function

Evaluation board

Name	Part number	Note
Evaluation board	MB91906EB	<ul style="list-style-type: none"> Main board + daughter board FlashROM, DRAM, etc. Built-in AC100 V, ACAdapter is bundled.
Evaluation board for MB91362GA	MB91913EB	It can be used only.

Programmer for Flash microcontroller

• Parallel programmer

Product name	Package (lead pitch, body size)	Package code	Adapter unit	
			Flash Support Group, Inc. *5	MINATO ELECTRONICS INC. *6
MB91F362GBPFVS	QFP-208 (0.5mm, □28 × 28 mm)	FPT-208P-M04	—	MF00-892 (for MODEL1893/1931) MF05-892 (for MODEL1940)
MB91F364GPMT MB91F365GBPMT MB91F366GBPMT MB91F367GBPMT MB91F368GBPMT MB91F376GPMT	LQFP-120 (0.5 mm, □16 × 16 mm)	FPT-120P-M21	—	MF00-964 (for MODEL1893/1931)
MB91F369GAPQS1	QFP-160 (0.65 mm, □28 × 28 mm)	FPT-160P-M15	—	MF00-1272 (for MODEL1893/1931) MF05-1272 (for MODEL1940)

• Serial programmer

Product name	Serial programmer
	Yokogawa Digital Computer Corporation *7
MB91F362GBPFVS MB91F369GAPQS1	NETIMPRESS

*1: The header requires the NQPACK manufactured by Tokyo Eletech Co.
<Contacted: 81-3-5295-1661

*2: The IC socket is mounted on the foot pattern on the user board.

*3 : The NQPACK and HQPACK can be used to hold and cover a chip, respectively.

*4 : A ROM alternate unit is used connecting with a CPU bus. In the case of use, it is necessary to design so that ROM alternate unit can be connected on target board.

*5 : Flash Support Group, Inc.

<Contact> TEL : 053-428-8383
<http://www.j-fsg.co.jp/e/top.html>

*6 : MINATO ELECTRONICS INC.

<Contact> TEL : 045-591-5611, FAX : 045-592-2854
http://www.minato.co.jp/index_e.asp

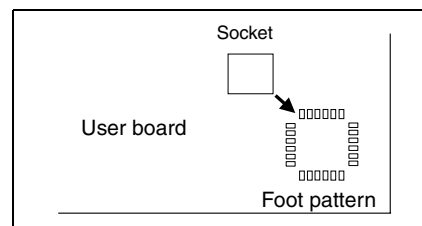

For MB91460 series

In Circuit Emulator (made by Fujitsu Microelectronics)

• Standard tool

Name	Part number	Note
Evaluation device	MB91V460RB-ES	• BGA660, DSU4
Evaluation device for MB91461	MB91461PMC-GSE1	• LQFP-176P, DSU4
Emulator main unit for FR (DSU3/4)	MB2198-01	<ul style="list-style-type: none"> • The systems development support tool which used MCU for evaluating FR and builds in DSU interface. • Power supply voltage: AC100 V or AC200 V • Dimensions: 150 mm (width) × 210 mm (depth) × 46 mm (height) • Weight: 2.7 kg • MB2198-10 (DSU3/4 cable) is required separately
DSU3/4 cable	MB2198-10	Used to connect the MB2198-01 to the adapter board

• Adapter board/Header board

Target device	Name	Part number	Note
MB91461 (LQFP-176)	Adapter board	-	-
	Header board	-	-
MB91F463N (LQFP-64)	Adapter board	MB2198-300A	• MB91V460RB-ES is required separately
	Header board (non level shifter)	MB2198-304A-E	• NQPACK064SB and HQPACK064SB140 are bundled *1
MB91F464A (LQFP-100)	Adapter board	MB2198-600A5	<ul style="list-style-type: none"> • MB91V460RB-ES is mounted • FME P/N:EMA-MB91V460A-002B-80
	Adapter board (GHS conforming)	MB2198-600A4	<ul style="list-style-type: none"> • MB91V460RB-ES is mounted • FME P/N:EMA-MB91V460A-003 • Corresponds to the Super Trace Probe made by Green Hills Software, Inc.
	Header board (non level shifter)	MB2198-606	<ul style="list-style-type: none"> • NQPACK100SD-ND and HQPACK100SD are required separately *1 • FME P/N:EMA-MB91F464A-NLS-100M20
MB91F465K (LQFP-120)	Adapter board	MB2198-600A5	<ul style="list-style-type: none"> • MB91V460RB-ES is mounted • FME P/N:EMA-MB91V460A-002B-80
	Adapter board (GHS conforming)	MB2198-600A4	<ul style="list-style-type: none"> • MB91V460RB-ES is mounted • FME P/N:EMA-MB91V460A-003 • Corresponds to the Super Trace Probe made by Green Hills Software, Inc.
	Header board (non level shifter)	MB2198-609	<ul style="list-style-type: none"> • NQPACK120SD and HQPACK120SD are required separately *1 • FME P/N:EMA-MB91F465K-NLS-120M21
MB91F465X (LQFP-100)	Adapter board	MB2198-600A5	<ul style="list-style-type: none"> • MB91V460RB-ES is mounted • FME P/N:EMA-MB91V460A-002B-80
	Adapter board (GHS conforming)	MB2198-600A4	<ul style="list-style-type: none"> • MB91V460RB-ES is mounted • FME P/N:EMA-MB91V460A-003 • Corresponds to the Super Trace Probe made by Green Hills Software, Inc.
	Header board (non level shifter)	MB2198-602	<ul style="list-style-type: none"> • NQPACK100SD and HQPACK100SD are required separately *1 • FME P/N:EMA-MB91F465X-NLS-100M20
	FlexRay expansion board	MB2198-603	• FME P/N:EMA-MB91V460A-100

32-bit FR Family Support Tools

Target device	Name	Part number	Note
MB91F467B MB91F465B (LQFP-144)	Adapter board	MB2198-600A5	<ul style="list-style-type: none"> • MB91V460RB-ES is mounted • FME P/N:EMA-MB91V460A-002B-80
	Adapter board (GHS conforming)	MB2198-600A4	<ul style="list-style-type: none"> • MB91V460RB-ES is mounted • FME P/N:EMA-MB91V460A-003 • Corresponds to the Super Trace Probe made by Green Hills Software, Inc.
	Header board (non level shifter)	MB2198-604B	<ul style="list-style-type: none"> • NQPACK144SD-ND and HQPACK144SD are required separaterly *1 • FME P/N:EMA-MB91F467B-NLS-144M08
	Header board (level shifter)	MB2198-634B	<ul style="list-style-type: none"> • Multi power supply I/O, with level shifter • NQPACK144SD-ND and HQPACK144SD are required separaterly *1 • FME P/N:EMA-MB91F467B-LS-144M08
	Header board (for single chip)	MB2198-664B	<ul style="list-style-type: none"> • NQPACK144SD-ND and HQPACK144SD are required separaterly *1 • FME P/N:EMA-MB91F467B-SC-144M08
MB91F467C (LQFP-144)	Adapter board	MB2198-600A5	<ul style="list-style-type: none"> • MB91V460RB-ES is mounted • FME P/N:EMA-MB91V460A-002B-80
	Adapter board (GHS conforming)	MB2198-600A4	<ul style="list-style-type: none"> • MB91V460RB-ES is mounted • FME P/N:EMA-MB91V460A-003 • Corresponds to the Super Trace Probe made by Green Hills Software, Inc.
	Header board (non level shifter)	MB2198-607	<ul style="list-style-type: none"> • NQPACK144SD-ND and HQPACK144SD are required separaterly *1 • FME P/N:EMA-MB91F467B-NLS-144M08
MB91F467D (QFP-208)	Adapter board	MB2198-600A5	<ul style="list-style-type: none"> • MB91V460RB-ES is mounted • FME P/N:EMA-MB91V460A-002B-80
	Adapter board (GHS conforming)	MB2198-600A4	<ul style="list-style-type: none"> • MB91V460RB-ES is mounted • FME P/N:EMA-MB91V460A-003 • Corresponds to the Super Trace Probe made by Green Hills Software, Inc.
	Header board (non level shifter)	MB2198-605B	<ul style="list-style-type: none"> • NQPACK208SD and HQPACK208SD are required separaterly *1 • FME P/N:EMA-MB91F467D-NLS-208M04
	Header board (level shifter)	MB2198-635B	<ul style="list-style-type: none"> • Multi power supply I/O, with level shifter • NQPACK208SD and HQPACK208SD are required separaterly *1 • FME P/N:EMA-MB91F467D-LS-208M04
MB91F467R (LQFP-176)	Adapter board	MB2198-300A	<ul style="list-style-type: none"> • MB91V460RB-ES is required separaterly
	Header board (level shifter)	MB2198-305	<ul style="list-style-type: none"> • NQPACK176SD and HQPACK176SD are bundled *1
MB91F467R (LQFP-176)	Adapter board	MB2198-600A5	<ul style="list-style-type: none"> • MB91V460RB-ES is mounted • FME P/N:EMA-MB91V460A-002B-80
	Adapter board (GHS conforming)	MB2198-600A4	<ul style="list-style-type: none"> • MB91V460RB-ES is mounted • FME P/N:EMA-MB91V460A-003 • Corresponds to the Super Trace Probe made by Green Hills Software, Inc.
	Header board (non level shifter)	MB2198-601	<ul style="list-style-type: none"> • NQPACK176SD and HQPACK176SD are required separaterly*1 • FME P/N:EMA-MB91F467R-NLS-176M07
MB91F469G (BGA320P)	Adapter board	MB2198-600A5	<ul style="list-style-type: none"> • MB91V460RB-ES is mounted • FME P/N:EMA-MB91V460A-002B-80
	Adapter board (GHS conforming)	MB2198-600A4	<ul style="list-style-type: none"> • MB91V460RB-ES is mounted • FME P/N:EMA-MB91V460A-003 • Corresponds to the Super Trace Probe made by Green Hills Software, Inc.
	Header board (non level shifter)	MB2198-608	<ul style="list-style-type: none"> • CSPACK256Y2027FJ02 is required separaterly • FME P/N:EMA-MB91F469G-NLS-320M06
	Header board (level shifter)	MB2198-638	<ul style="list-style-type: none"> • CSPACK256Y2027FJ02 is required separaterly • FME P/N:EMA-MB91F469G-LS-320M06

• Evaluation board

Name	Part number	Note
MB91F464A evaluation board	MB2198-606SK	Only the evaluation board can be used.
MB91F465K evaluation board	MB2198-609SK	Only the evaluation board can be used.
MB91F467B evaluation board	MB2198-604SK	Only the evaluation board can be used.
MB91F467C evaluation board	MB2198-607SK	Only the evaluation board can be used.
MB91F467D evaluation board	MB2198-605SK	Only the evaluation board can be used.
MB91F467R evaluation board	MB2198-601SK	Only the evaluation board can be used.
MB91F469G evaluation board	MB2198-608SK	Only the evaluation board can be used.

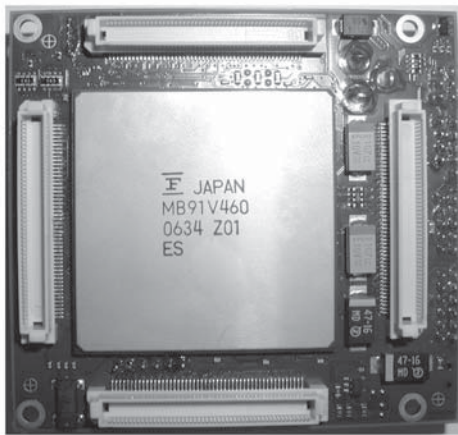

MB2198-600

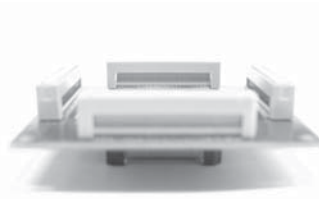

MB2198-60x, MB2198-63x

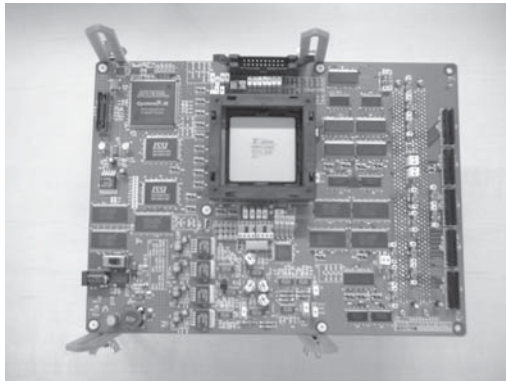

MB2198-300A

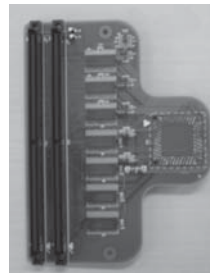

MB2198-30x

*1: The header requires the NQPACK manufactured by Tokyo Eletech Co.
 <Contact>TEL: 81-3-5295-1661
 The IC socket is mounted on the foot pattern on the user board.
 The NQPACK and HQPACK can be used to hold and cover a chip,
 respectively.

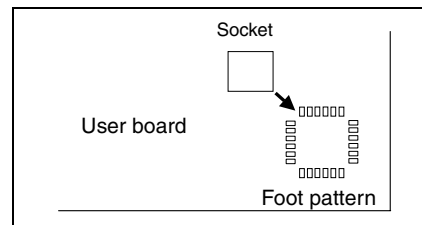

32-bit FR Family Support Tools

For MB91470/480 series

In Circuit Emulator (made by Fujitsu Microelectronics)

- Standard tool

Name	Part number	Note
Evaluation device	MB91FV470BGL-ESE1	• BGA660, DSU4
Emulator main unit for FR (DSU3/4)	MB2198-01	<ul style="list-style-type: none"> • The systems development support tool which used MCU for evaluating FR and builds in DSU interface. • Power supply voltage: AC100 V or AC200 V • Dimensions: 150 mm (width) × 210 mm (depth) × 46 mm (height) • Weight: 2.7 kg • MB2198-10 (DSU3/4 cable) is required separately
DSU3/4 cable	MB2198-10	Used to connect the MB2198-01 to the adapter board.
Adapter board	MB2198-160	<ul style="list-style-type: none"> • Connection to MB2198-10 • Header I/F cable is bundled
Pseudo power-on debug adapter	MB2198-169	Connection between adapter board and header board.

- Header board

Name	Part number	Note
Header board for MB91470 (LQFP-144)	MB2198-161	• NQPACK144SE and HQPACK144SE are bundled *1
Header board for MB91480 (LQFP-100)	MB2198-162	• NQPACK100SD-ND and HQPACK100SD are bundled *1

Programmer for Flash microcontroller

- Serial programmer

Product name	Serial programmer
	Yokogawa Digital Computer Corporation *2
MB91F475 MB91F478 MB91F479 MB91F482 MB91F487	NETIMPRESS (For MB91F478 and MB91F482 are under development)

*1: The header requires the NQPACK manufactured by Tokyo Eletech Co.

<Contact>TEL: 81-3-5295-1661

The IC socket is mounted on the foot pattern on the user board.

The NQPACK and HQPACK can be used to hold and cover a chip, respectively.

*2 : Yokogawa Digital Computer Corporation

<Contact> TEL: 042-333-6224 FAX : 042-352-6107

<http://www.yokogawa-digital.com/emb/en/index.html>

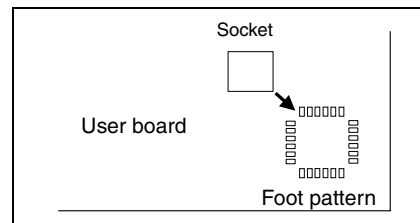

For MB91605 series

In Circuit Emulator (made by Fujitsu Microelectronics)

- Standard tool

Name	Part number	Note
Evaluation device	MB91605PMC-GE1	• BGA-544, DSU4
Emulator main unit for FR (DSU3/4)	MB2198-01	<ul style="list-style-type: none"> • The systems development support tool which used MCU for evaluating FR and builds in DSU interface. • Power supply voltage: AC100 V or AC200 V • Dimensions: 150 mm (width) × 210 mm (depth) × 46 mm (height) • Weight: 2.7 kg
MB91605 adapter	MB2198-81-E	<ul style="list-style-type: none"> • Adapter board, memory board, header board are bundled • NQPACK176SD and HQPACK176SD are bundled *1

For MB91635 series

In Circuit Emulator (made by Fujitsu Microelectronics)

- Standard tool

Name	Part number	Note
Evaluation device	MB91V650PB-ESE1	• BGA-544, DSU4
Emulator main unit for FR (DSU3/4)	MB2198-01	<ul style="list-style-type: none"> • The systems development support tool which used MCU for evaluating FR and builds in DSU interface. • Power supply voltage: AC100 V or AC200 V • Dimensions: 150 mm (width) × 210 mm (depth) × 46 mm (height) • Weight: 2.7 kg
Adapter board	MB2198-700-E	• Configuration board (MB2198-790-01-E) is bundled

- Header board

Name	Part number	Note
Header board for MB91635 (LQFP-144)	MB2198-702-E	• NQPACK144SD-ND and HQPACK144SD are bundled *1

Evaluation board

Name	Part number	Note
Main board	BBF2004-MB	Made by Sunhayato
Daughter board	BBF2004-FR144SQF-NB	Made by Sunhayato For LQFP-144

32-bit FR Family Support Tools

For MB91645 series

In Circuit Emulator (made by Fujitsu Microelectronics)

- Standard tool

Name	Part number	Note
Evaluation device	MB91V650PB-ESE1	• BGA-544, DSU4
Emulator main unit for FR (DSU3/4)	MB2198-01	<ul style="list-style-type: none"> • The systems development support tool which used MCU for evaluating FR and builds in DSU interface. • Power supply voltage: AC100 V or AC200 V • Dimensions: 150 mm (width) × 210 mm (depth) × 46 mm (height) • Weight: 2.7 kg
Adapter board	MB2198-700-E	• Configuration board (MB2198-790-01-E) is bundled

- Header board

Name	Part number	Note
Header board for MB91645 (LQFP-176)	MB2198-703-E	• NQPACK176SD and HQPACK176SD are bundled *1

Evaluation board

Name	Part number	Note
Main board	BBF2004-MB	Made by Sunhayato
Daughter board	BBF2004-FR176SQF-NB	Made by Sunhayato For LQFP-176 (Sales beginning schedule at the end of October in 2007.)

For MB91660 series

In Circuit Emulator (made by Fujitsu Microelectronics)

- Standard tool

Name	Part number	Note
Evaluation device	MB91V650PB-ESE1	• BGA-544, DSU4
Emulator main unit for FR (DSU3/4)	MB2198-01	<ul style="list-style-type: none"> • The systems development support tool which used MCU for evaluating FR and builds in DSU interface. • Power supply voltage: AC100 V or AC200 V • Dimensions: 150 mm (width) × 210 mm (depth) × 46 mm (height) • Weight: 2.7 kg
Adapter board	MB2198-700-E	• Configuration board (MB2198-790-01-E) is bundled

- Header board

Name	Part number	Note
Header board for MB91645 (LQFP-120)	MB2198-701-E	• NQPACK120SD and HQPACK120SD are bundled *1

Evaluation board

Name	Part number	Note
Main board	BBF2004-MB	Made by Sunhayato
Daughter board	BBF2004-FR120SUS-NB	Made by Sunhayato For LQFP-120 (Sales beginning schedule at the end of December in 2007.)

■ Parallel programmer for Flash microcontroller

The parallel programmer in Flash memory of the FR family is supported as the following programmer.

Flash Support Group, Inc.

- **Flash Programmer**

AF9708, AF9709/B: 3 V-products, 5 V-products.



AF9708

AF9709

- **Gang programmer**

AF9723: 3 V-products, 5 V-products



MINATO ELECTRONICS INC.

- **Universal Programmer**

MODEL 1890A + OU910 (Ver. 4.32b or more)



Notes:

This programmer ended in September, 2000. It is a schedule of correspondence with MODEL1881 (The current state uncorresponds) for the future. Please confirm to MINATO ELECTRONICS INC. when you buy.

MODEL1890A is scheduled to be done in the future to support.

- **Gang Programmer**

MODEL 1893 (Ver. 1.10L or more) , MODEL 1931 (Ver 1.10L or more)
MODEL 1930 + SU3000LX (Ver. 4.10L or more)



MODEL 1893

- **Gang programmer**

MODEL1940 (Ver. 1.32C or more)



MODEL 1940

FR families Evaluation Board

- The FR30 series evaluation board can be used as a target board for running the emulator.
The board consists of a main board and a daughter board. The main board can be used commonly for the FR30 series of microcontrollers.
- Since the evaluation board has SDRAM, DRAM, and Flash memory mounted, it can be used to test CPU performance or to configure a hardware circuit using the extension board connector on the main board.
- The ROM alternate unit (MB2197-90) can be connected to the evaluation board.
- The evaluation board can be used in combination with the MB2197-01 (emulator), for example, in the following configuration:
MB2197-01 + MB2197-10 + MB91906EB (main board)
+ MB91901EB (daughter board)

System overview

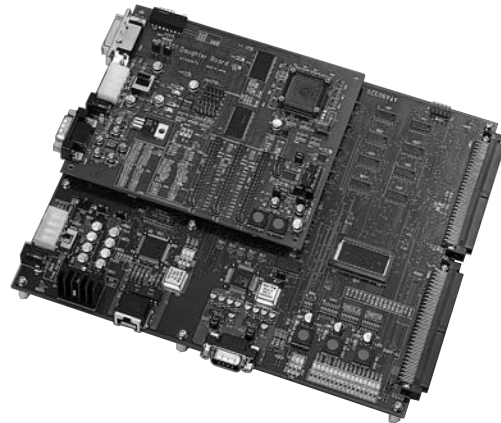

Evaluation board block diagram

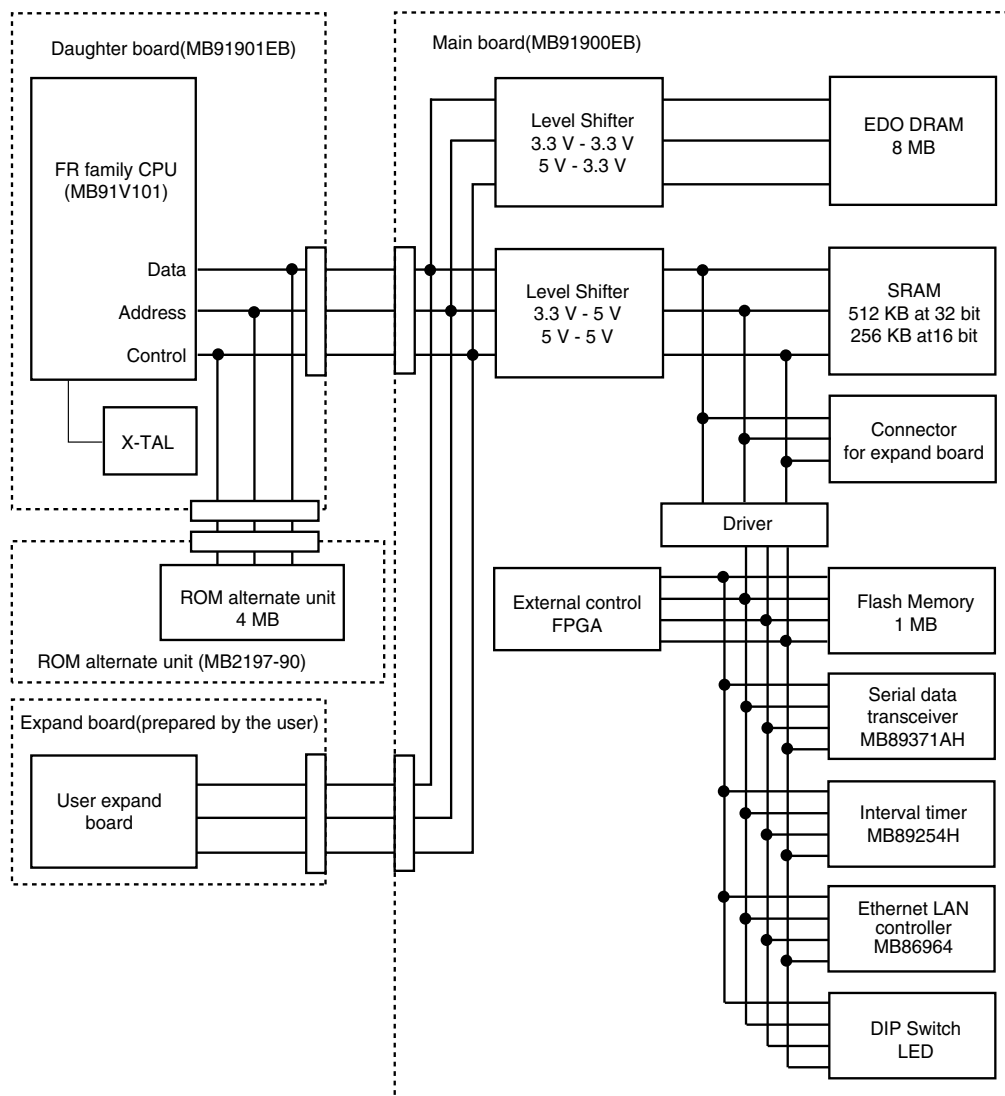

■ Main Board

Name	Part number	Remarks
Evaluation board for FR families (NEW MAIN BOARD)	MB91906EB	<ul style="list-style-type: none"> • With 100-V AC adapter. • It is available according to the combination of daughter board as the target board of FR family for 3V or 5V power supply voltage (MB91130 is excluded). • The capacity of Flash memory or DRAM is increased. • The succeeding model of MB91900EB (the evaluation board for FR family) .

■ Daughter Board

Name	Part number	Remarks
Daughter board for MB91101A	MB91901EB	<ul style="list-style-type: none"> • It is two piece composition of NEW MAIN BOARD (MB91906EB) + daughter board and available. • MB91V101A pre mounted. • Connectable with In Circuit Emulator made by Fujitsu Microelectronics.
	MB91902EB	Connectable with In Circuit Emulator for MB91101A made by Yokogawa Digital Computer Corporation.
Daughter board for MB91107/108/121	MB91907EB	Connectable with In Circuit Emulator made by Fujitsu Microelectronics. It is two piece composition of NEW MAIN BOARD (MB91906EB) + daughter board and available.
Daughter board for MB91F130	MB91908EB	Connectable with In Circuit Emulator made by Fujitsu Microelectronics by using the evaluation board.
Daughter board for MB91150 series	MB91911EB	It is two piece composition of NEW MAIN BOARD (MB91906EB) + daughter board and available.
Evaluation board for MB91F230	MB91920EB	Use only on an evaluation board is possible.
Evaluation board for MB91260	MB91921EB	Use only on an evaluation board is possible.
Daughter board for MB91302A	MB91914EB	It is two piece composition of NEW MAIN BOARD (MB91906EB) + daughter board and available.
Daughter board for MB91305	MB91925EB	Use only on an evaluation board is possible.
Daughter board for MB91306/307	MB91915EB	It is two piece composition of NEW MAIN BOARD (MB91906EB) + daughter board and available.
Evaluation board for MB91310	MB91918EB	Use only on an evaluation board is possible.
Daughter board for MB91F353	MB91922EB	It is two piece composition of NEW MAIN BOARD (MB91906EB) + daughter board and available.
Daughter board for MB91F355	MB91916EB	It is two piece composition of NEW MAIN BOARD (MB91906EB) + daughter board and available.
Daughter board for MB91362GA	MB91913EB	It is two piece composition of NEW MAIN BOARD (MB91906EB) + daughter board and available.
Daughter board for MB91369GA	Under development	It is two piece composition of NEW MAIN BOARD (MB91906EB) + daughter board and available.

■ Simple Target Board

Name	Part number	Remarks
Simple target board for In Circuit Emulator connection for MB91101A (FR30 SRAM board)	MB91903EB	<ul style="list-style-type: none"> • It is two piece composition of NEW MAIN BOARD (MB91906EB) + simple target board and available. • MB91V101A pre mounted. • Connectable with In Circuit Emulator for MB91101A made by Fujitsu Microelectronics.

■ F²MC-FR Family Evaluation Board (BBF2004) : Sunhayato

This is an evaluation board made by Sunhayato corp. in correspondence with Fujitsu Microelectronics F²MC-16LX families. It can be used to verify the operating status of F²MC-16LX families before they are actually embedded into a customer's system. As a consequence, development efficiency is accelerated.

This board consists of a main board and a daughter board. By changing the daughter board, it can be used for debugging with the (In Circuit Emulator) tool combined with the emulator debugger, evaluating a microcomputer with built-in Flash memory and a serial programming. The board is adaptable to various series by changing the daughter board, while the main board is common to each part.

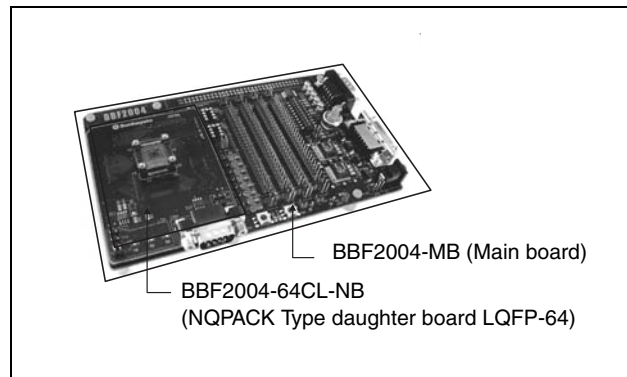

• Evaluation board configuration

Main board (BBF2004-MB)

Daughter board (BBF2004-64CL-NB)

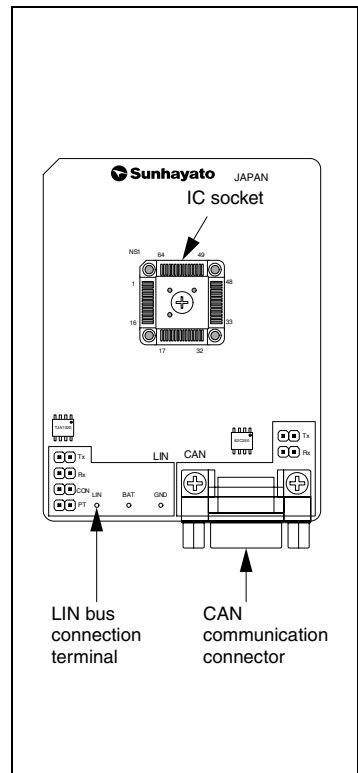
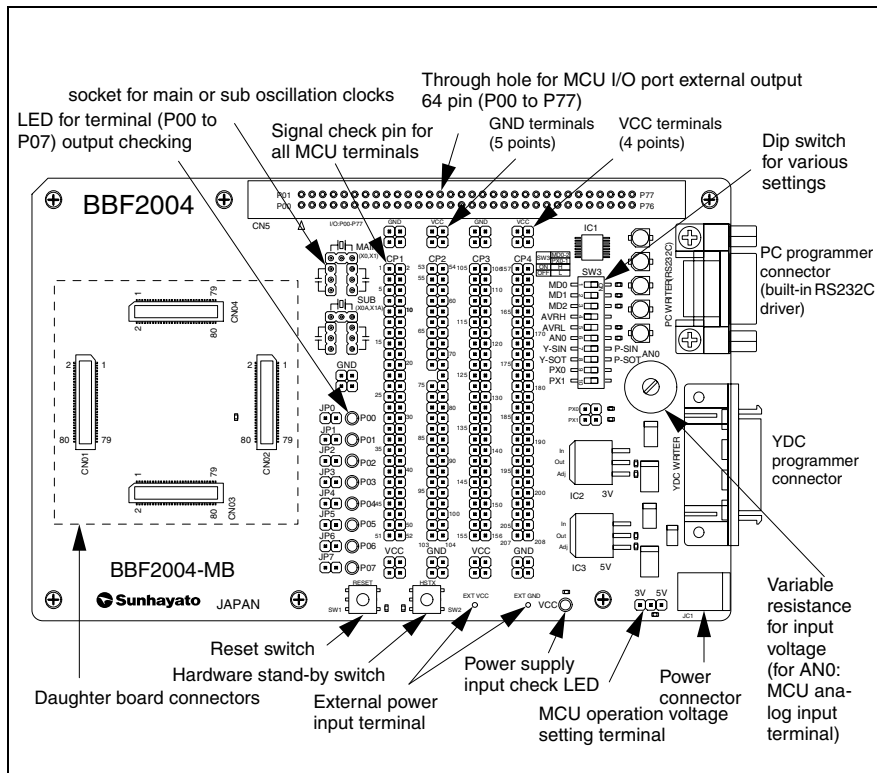

• **Product configuration**

Main board

Part number	Description
BBF2004-MB	<ul style="list-style-type: none"> - Locating signal check pin to all terminals - Capability of changing input voltage to analog input terminal AN0 (by variable resistor) - Function of LED lightning for output port (P00 to P17) - Evaluate the capability of communication between PC and microcomputer with UART (mounted DSUB 9pin is possible.) - Can be use the serial programmer made by Fujitsu Microelectronics - Can be use the serial programmer made by Yokogawa Digital Computer corp.

Daughter board

Part number	Description	Target microcontroller	Usage
BBF2004-FR64CAN-NB	NQPACK type (0.65 mm pitch, □12 mm × 12 mm)	MB91265 series	Evaluation board connectable with (In Circuit Emulator) tool. Board for writing and evaluating a microcomputer with a built-in Flash memory.
BBF2004-FR100SCL-NB	NQPACK type (0.50 mm pitch, □14 mm × 14 mm)	MB91270 series	
BBF2004-FR144SCL-NB	NQPACK type (0.50 mm pitch, □20 mm × 20 mm)	MB91270 series	
BBF2004-FR144SQF-NB	NQPACK type (0.50 mm pitch, □20 mm × 20 mm)	MB91635 series	
BBF2004-FR176SQF-NB	NQPACK type (0.50 mm pitch, □24 mm × 24 mm)	MB91645 series	

*: Includes CAN transceiver and LIN transceiver

Main board + Daughter board

Part number	Description	Target microcontroller	Usage
BBF2004-FR64CAN-NS *	Main board + NQPACK type (0.65 mm pitch, □12 mm × 12 mm)	MB91265 series	Evaluation board connectable with (In Circuit Emulator) tool. Board for writing and evaluating a microcomputer with a built-in Flash memory.
BBF2004-FR100SCL-NS *	Main board + NQPACK type (0.50 mm pitch, □14 mm × 14 mm)	MB91270 series	
BBF2004-FR144SCL-NS *	Main board + NQPACK type (0.50 mm pitch, □20 mm × 20 mm)	MB91270 series	
BBF2004-FR144SQF-NS	Main board + NQPACK type (0.50 mm pitch, □20 mm × 20 mm)	MB91635 series	
BBF2004-FR176SQF-NS	Main board + NQPACK type (0.50 mm pitch, □24 mm × 24 mm)	MB91645 series	

*: The daughter board includes CAN transceiver and LIN transceiver.

Target microcontroller

Series name	Package (lead pitch, body size) (mm)
MB91265 series *	LQFP-64 (0.65 mm pitch, □ 12 mm × 12 mm)
MB91270 series *	LQFP-100 (0.50 mm pitch, □ 14 mm × 14 mm)
MB91635 series	LQFP-144 (0.50 mm pitch, □ 20 mm × 20 mm)
MB91645 series	LQFP-176 (0.50 mm pitch, □ 24 mm × 24 mm)

*: Includes CAN transceiver and LIN transceiver

Contact for details: Sunhayato Corp. TEL +81-3-3984-7791, FAX +81-3-3971-0535

Monitor Debugger ACCEMIC MDE (Accemic GmbH & Co. KG)

Even if development tools are not used, ACCEMIC *1 MDE *2 enables debugging with the flash microcontroller by embedding a debug monitor program and communicating with a host computer during the target program's execution.

*1: ACCEMIC : ACCElerate MICRocontroller designs
*2: MDE : Monitor Debugger Environment

Feature

- Debugging with PC and Flash microcontroller
- Less stress for the microcontroller resources because of the UART function for writing serial data
- Breaking and stepping
- Monitoring memory
- Verify register values on the operating screen
- Setting ports and changing register values without changing programs

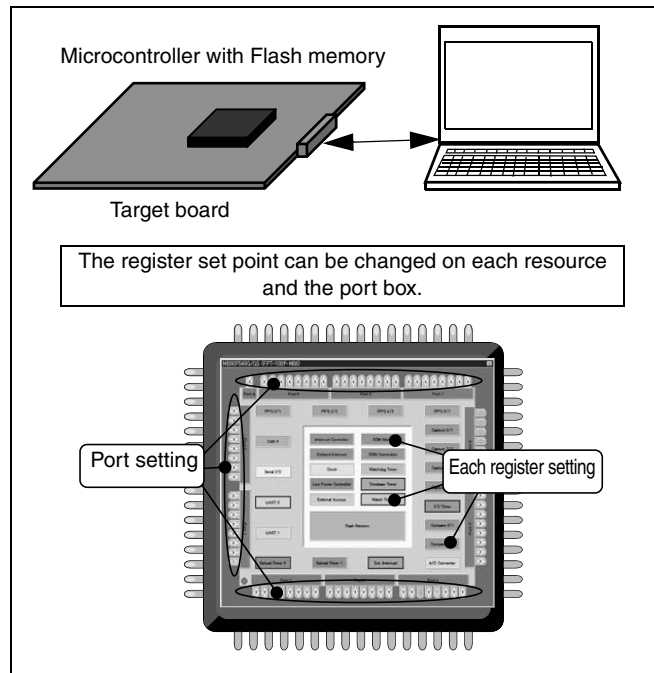

Debugging operating screen

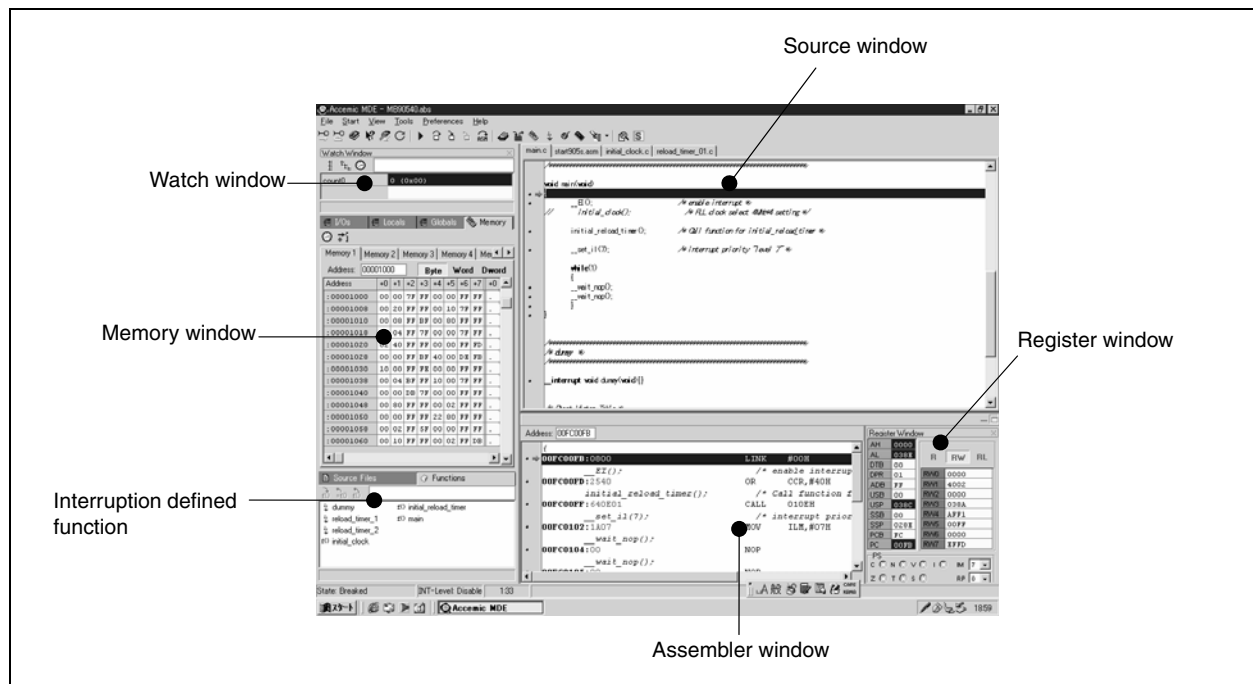

Support MCU

MB91F267, MB91F272, MB91F353A, MB91F355A, MB91461, MB91F464A, MB91F465K, MB91F467D, MB91F475, MB91F478, MB91F479

Contact: FUJITSU ELECTRONICS INC. TEL : 03-5908-8610
Accemic GmbH & Co. KG <http://www.accemic.com/>

Green Hills Software's MULTI® 5 Integrated Development Environment

Green Hills Software's MULTI 5 Integrated Development Environment (IDE) includes the industry's most powerful and proven tools for developing embedded software. The MULTI 5 release of the most successful embedded IDE in history enables enterprises to achieve total reliability, absolute security and maximum performance with the lowest manufacturing and development costs, while getting to market in record time. In addition to streamlining the software development process, MULTI 5 makes it easier and faster than ever to find even the most difficult bugs.

Features a variety of new productivity-enhancing capabilities:

- DoubleCheck™@Source Code Analyzer - a new static source code analysis tool that examines the entire application to find reliability and security flaws such as buffer overflows, resource leaks, and overly complex functions
- a new distributed build system that dramatically reduces build times
- a new project manager to help create and maintain with ease even the most complex applications
- improved code generation for the smallest and fastest code possible
- improved visibility and graphical management of CPU and board level hardware features

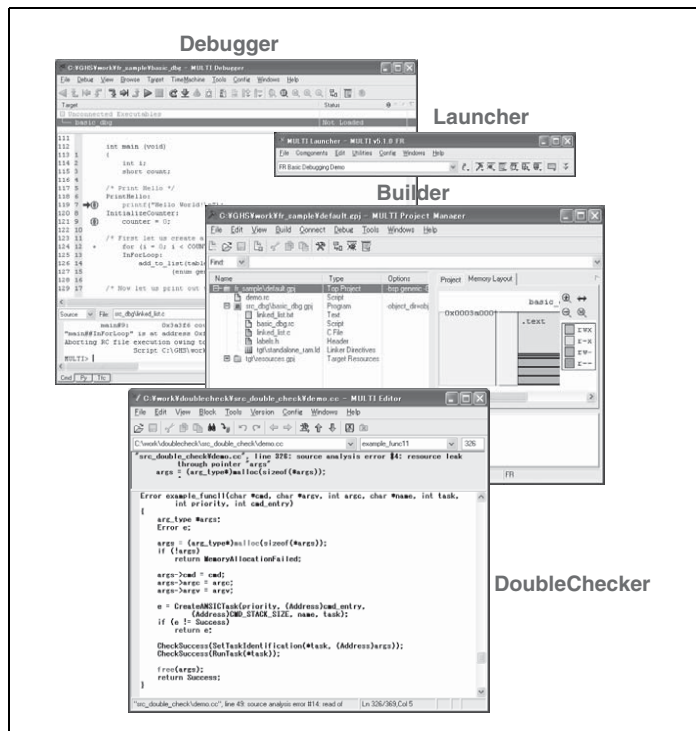

FR Family Support tools

and other various advanced feature that supports embedded system developer.

Green Hills Software's MULTI® TimeMachine™ Suite

The MULTI TimeMachine debugging suite combines a familiar debugger interface with innovative functions of MULTI-IDE that enable developers to step and run forward and backward through their code. It's based on SuperTrace Probe which can capture up to 1 GB of trace data.

Fix bugs faster

With TimeMachine, developers can more readily explore processor execution and, as a result, find and fix bugs faster.

Optimize with ease

Along with the PathAnalyzer and FunctionFlow, the TimeMachine suite integrates the patented MULTI Profiler to offer the capabilities to help you more easily identify performance problems in embedded code.

Supported Processors

FR 20/30/60/70/80 family

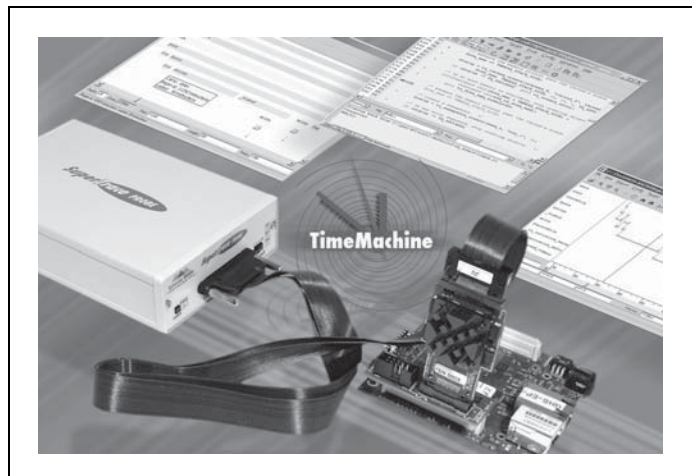

Sales contacts : Advanced Data Controls Corp. Sales Division TEL : +81-3-3576-5351
E-mail: sales@adac.co.jp http://www.adac.co.jp

Microcontrollers (8-bit Proprietary F²MC-8L Family)

Microcontrollers (8-bit Proprietary F²MC-8L Family)

Series	Part number	Application	Package [pin]	Operating voltage : V _{CC} [V]	Internal clock frequency [Max., MHz]	Sub-clock	Memory type	ROM [byte]	RAM [byte]	External interrupts [ch.]	External bus	A/D converter [bit x ch.]	D/A converter [bit x ch.]	Timer		
														16-bit timer [ch.]	Output compare [ch.]	Input capture [ch.]
MB89051	MB89051	USB	64	3 or 5	12	-	MASK	32K	2K	7	-	-	-	-	-	-
MB89051	MB89F051	USB	64	3 or 5	12	-	FLASH	32K	2K	7	-	-	-	-	-	-
MB89120/A	MB89121	Standard	48	3 or 5	4.2	Yes	MASK	4K	128	3	-	-	-	-	-	-
MB89120/A	MB89123A	Standard	48	3 or 5	4.2	Yes	MASK	8K	256	11	-	-	-	-	-	-
MB89120/A	MB89125A	Standard	48	3 or 5	4.2	Yes	MASK	16K	256	11	-	-	-	-	-	-
MB89130/A	MB89131	Standard	48	3 or 5	4.2	Yes	MASK	4K	128	3	-	8bit x 4	-	-	-	-
MB89130/A	MB89133A	Standard	48	3 or 5	4.2	Yes	MASK	8K	256	11	-	8bit x 4	-	-	-	-
MB89130/A	MB89135A	Standard	48	3 or 5	4.2	Yes	MASK	16K	256	11	-	8bit x 4	-	-	-	-
MB89130/A	MB89P131	Standard	48	3 or 5	4.2	Yes	OTP	4K	128	3	-	8bit x 4	-	-	-	-
MB89130/A	MB89P133A	Standard	48	3 or 5	4.2	Yes	OTP	8K	256	11	-	8bit x 4	-	-	-	-
MB89130/A	MB89P135A	Standard	48	3 or 5	4.2	Yes	OTP	16K	512	11	-	8bit x 4	-	-	-	-
MB89140	MB89143A	VFD	64	5	8	Yes	MASK	8K	256	2	-	8bit x 8	-	-	-	-
MB89140	MB89144A	VFD	64	5	8	Yes	MASK	12K	256	2	-	8bit x 8	-	-	-	-
MB89140	MB89145	VFD	64	3 or 5	8	Yes	MASK	16K	512	2	-	10bit x 12	-	-	-	-
MB89140	MB89146	VFD	64	3 or 5	8	Yes	MASK	24K	768	2	-	10bit x 12	-	-	-	-
MB89140	MB89P147	VFD	64	3 or 5	8	Yes	OTP	32K	1K	2	-	10bit x 12	-	-	-	-
MB89160/A	MB89161/A	LCD controller	80	3 or 5	4.2	Yes	MASK	4K	128	12	-	8bit x 8	-	-	-	-
MB89160/A	MB89163/A	LCD controller	80	3 or 5	4.2	Yes	MASK	8K	256	12	-	8bit x 8	-	-	-	-
MB89160/A	MB89165/A	LCD controller	80	3 or 5	4.2	Yes	MASK	16K	512	12	-	8bit x 8	-	-	-	-
MB89160/A	MB89P165	LCD controller	80	3 or 5	4.2	Yes	OTP	16K	512	12	-	8bit x 8	-	-	-	-
MB89190/A/AH	MB89191	Standard	28	3 or 5	4.2	-	MASK	4K	128	11	-	-	-	1	-	-
MB89190/A/AH	MB89191A	Standard	28	3 or 5	4.2	-	MASK	4K	128	11	-	8bit x 8	-	1	-	-
MB89190/A/AH	MB89191AH	Standard	28	3 or 5	4.2	-	MASK	4K	128	11	-	8bit x 8	-	1	-	-
MB89190/A/AH	MB89193	Standard	28	3 or 5	4.2	-	MASK	8K	256	11	-	-	-	1	-	-
MB89190/A/AH	MB89193A	Standard	28	3 or 5	4.2	-	MASK	8K	256	11	-	8bit x 8	-	1	-	-
MB89190/A/AH	MB89193AH	Standard	28	3 or 5	4.2	-	MASK	8K	256	11	-	8bit x 8	-	1	-	-
MB89190/A/AH	MB89195	Standard	28	3 or 5	4.2	-	MASK	16K	256	11	-	-	-	1	-	-
MB89190/A/AH	MB89195A	Standard	28	3 or 5	4.2	-	MASK	16K	256	11	-	8bit x 8	-	1	-	-
MB89190/A/AH	MB89P195	Standard	28	3 or 5	4.2	-	OTP	16K	256	11	-	-	-	1	-	-
MB89190/A/AH	MB89P195A	Standard	28	3 or 5	4.2	-	OTP	16K	256	11	-	8bit x 8	-	1	-	-
MB89202/R	MB89202	Standard	32	3 or 5	12.5	-	MASK	16K	512	11	-	10bit x 8	-	-	-	8bit x 2
MB89202/R	MB89202Y	Standard	34	3 or 5	12.5	-	MASK	16K	512	11	-	10bit x 8	-	-	-	8bit x 2
MB89202/R	MB89F202	Standard	32	3 or 5	12.5	-	FLASH	16K	512	11	-	10bit x 8	-	-	-	8bit x 2
MB89202/R	MB89F202RA *	Standard	32	3 or 5	12.5	-	FLASH	16K	512	11	-	10bit x 8	-	-	-	8bit x 2
MB89202/R	MB89F202RAY *	Standard	32/34	3 or 5	12.5	-	FLASH	16K	512	11	-	10bit x 8	-	-	-	8bit x 2
MB89202/R	MB89F202Y	Standard	34	3 or 5	12.5	-	FLASH	16K	512	11	-	10bit x 8	-	-	-	8bit x 2
MB89470	MB89475	Standard	48	3 or 5	12.5	Yes	MASK	16K	512	9	-	10bit x 8	-	2	-	-
MB89470	MB89P475	Standard	48	5	12.5	Yes	OTP	16K	512	9	-	10bit x 8	-	2	-	-
MB89480	MB89485	LCD controller	64	3 or 5	12.5	Yes	MASK	16K	512	12	-	10bit x 4	-	2	-	-
MB89480	MB89485L	LCD controller	64	3	12.5	Yes	MASK	16K	512	12	-	10bit x 4	-	2	-	-
MB89480	MB89P485	LCD controller	64	5	12.5	Yes	OTP	16K	512	12	-	10bit x 4	-	2	-	-
MB89480	MB89P485L	LCD controller	64	3	12.5	Yes	OTP	16K	512	12	-	10bit x 4	-	2	-	-
MB89490	MB89498	LCD controller	100	3	12.5	Yes	MASK	48K	2K	16	-	10bit x 8	-	2	-	-
MB89490	MB89F499	LCD controller	100	3	12.5	Yes	FLASH	60K	2K	16	-	10bit x 8	-	2	-	-
MB89530A	MB89535A	Standard	64	3 or 5	12.5	Yes	MASK	16K	512	12	-	10bit x 8	-	1	-	-
MB89530A	MB89537A	Standard	64	3 or 5	12.5	Yes	MASK	32K	1K	12	-	10bit x 8	-	1	-	-
MB89530A	MB89537AC	Standard	64	3 or 5	12.5	Yes	MASK	32K	1K	12	-	10bit x 8	-	1	-	-
MB89530A	MB89538A	Standard	64	3 or 5	12.5	Yes	MASK	48K	2K	12	-	10bit x 8	-	1	-	-
MB89530A	MB89538AC	Standard	64	3 or 5	12.5	Yes	MASK	48K	2K	12	-	10bit x 8	-	1	-	-
MB89530A	MB89F538	Standard	64	5	12.5	Yes	FLASH	48K	2K	11	-	10bit x 8	-	1	-	-
MB89530A	MB89F538L	Standard	64	3	12.5	Yes	FLASH	48K	2K	11	-	10bit x 8	-	1	-	-
MB89550A	MB89557A	LCD controller	100	3	12.5	Yes	MASK	32K	1K	16	-	10bit x 8	8bit x 2	3	-	-
MB89550A	MB89558A	LCD controller	100	3	12.5	Yes	MASK	48K	2K	16	-	10bit x 8	8bit x 2	3	-	-
MB89550A	MB89P558A	LCD controller	100	3 or 5	12.5	Yes	OTP	48K	2K	16	-	10bit x 8	8bit x 2	3	-	-
MB89560/A/H	MB89567A	LCD controller	80	3 or 5	12.5	Yes	MASK	32K	1K	12	-	10bit x 8	-	1	-	-
MB89560/A/H	MB89567AC	LCD controller	80	3 or 5	12.5	Yes	MASK	32K	1K	12	-	10bit x 8	-	1	-	-

*: Under development

Microcontrollers (8-bit Proprietary F²MC-8L Family)

Timer				Serial			Commu- nication	LCD controller [seg. x com.]	Invert er	VFD	Functions	Evaluation device	Part number	Series
PPG timer [ch.]	PWM timer [ch.]	PWC timer [ch.]	Up/ Down counter [ch.]	[ch.]	PC [ch.]	UART/ SIO [ch.]	USB- Function [ch.]							
-	8bit x 2	-	-	2	1	CP/2	1	-	-	-	USB-function:End point4	MB89F051	MB89051	MB89051
-	8bit x 2	-	-	2	1	CP/2	1	-	-	-	USB-function:End point4	MB89F051	MB89F051	MB89051
-	8bit x 2	-	-	1	-	- / 1	-	-	-	-	-	MB89PV130A	MB89121	MB89120/A
-	8bit x 2	-	-	1	-	- / 1	-	-	-	-	Remote-controller carrier generator	MB89PV130A	MB89123A	MB89120/A
-	8bit x 2	-	-	1	-	- / 1	-	-	-	-	Remote-controller carrier generator	MB89PV130A	MB89125A	MB89120/A
-	8bit x 2	-	-	1	-	- / 1	-	-	-	-	-	MB89PV130A	MB89131	MB89130/A
-	8bit x 2	-	-	1	-	- / 1	-	-	-	-	Remote-controller carrier generator	MB89PV130A	MB89133A	MB89130/A
-	8bit x 2	-	-	1	-	- / 1	-	-	-	-	Remote-controller carrier generator	MB89PV130A	MB89135A	MB89130/A
-	8bit x 2	-	-	1	-	- / 1	-	-	-	-	-	MB89PV130A	MB89P131	MB89130/A
-	8bit x 2	-	-	1	-	- / 1	-	-	-	-	Remote-controller carrier generator	MB89PV130A	MB89P133A	MB89130/A
-	8bit x 2	-	-	1	-	- / 1	-	-	-	-	Remote-controller carrier generator	MB89PV130A	MB89P135A	MB89130/A
-	8bit x 2	-	-	1	-	- / 1	-	-	Yes	-	VFD	MB89PV140	MB89143A	MB89140
-	8bit x 2	-	-	1	-	- / 1	-	-	Yes	-	VFD	MB89PV140	MB89144A	MB89140
12bit x 1	8bit x 3	-	-	1	-	- / 1	-	-	Yes	-	VFD	MB89PV140	MB89145	MB89140
12bit x 1	8bit x 3	-	-	1	-	- / 1	-	-	Yes	-	VFD	MB89PV140	MB89146	MB89140
12bit x 1	8bit x 3	-	-	1	-	- / 1	-	-	Yes	-	VFD	MB89PV140	MB89P147	MB89140
-	8bit x 2	-	-	1	-	- / 1	-	24 x 4	-	-	Remote-controller carrier generator	MB89PV160	MB89161/A	MB89160/A
-	8bit x 2	-	-	1	-	- / 1	-	24 x 4	-	-	Remote-controller carrier generator	MB89PV160	MB89163/A	MB89160/A
-	8bit x 2	-	-	1	-	- / 1	-	24 x 4	-	-	Remote-controller carrier generator	MB89PV160	MB89165/A	MB89160/A
-	8bit x 2	-	-	1	-	- / 1	-	24 x 4	-	-	Remote-controller carrier generator	MB89PV160	MB89P165	MB89160/A
-	-	-	-	1	-	- / 1	-	-	-	-	Remote-controller carrier generator	MB89PV190	MB89191	MB89190/A/AH
-	-	-	-	1	-	- / 1	-	-	-	-	Remote-controller carrier generator	MB89PV190A	MB89191A	MB89190/A/AH
-	-	-	-	1	-	- / 1	-	-	-	-	Remote-controller carrier generator	MB89PV190A	MB89191AH	MB89190/A/AH
-	-	-	-	1	-	- / 1	-	-	-	-	Remote-controller carrier generator	MB89PV190	MB89193	MB89190/A/AH
-	-	-	-	1	-	- / 1	-	-	-	-	Remote-controller carrier generator	MB89PV190A	MB89193A	MB89190/A/AH
-	-	-	-	1	-	- / 1	-	-	-	-	Remote-controller carrier generator	MB89PV190A	MB89193AH	MB89190/A/AH
-	-	-	-	1	-	- / 1	-	-	-	-	Remote-controller carrier generator	MB89PV190	MB89195	MB89190/A/AH
-	-	-	-	1	-	- / 1	-	-	-	-	Remote-controller carrier generator	MB89PV190A	MB89195A	MB89190/A/AH
-	-	-	-	1	-	- / 1	-	-	-	-	Remote-controller carrier generator	MB89PV190	MB89P195	MB89190/A/AH
-	-	-	-	1	-	- / 1	-	-	-	-	Remote-controller carrier generator	MB89PV190A	MB89P195A	MB89190/A/AH
12bit x 1	8bit x 1	-	-	1	-	1 / 1	-	-	-	-	Buzzer output	MB89V201	MB89202	MB89202/R
12bit x 1	8bit x 1	-	-	1	-	1 / 1	-	-	-	-	Buzzer output	MB89V201	MB89202Y	MB89202/R
12bit x 1	8bit x 1	-	-	1	-	1 / 1	-	-	-	-	Buzzer output	MB89V201	MB89F202	MB89202/R
12bit x 1	8bit x 1	-	-	1	-	1 / 1	-	-	-	-	Buzzer output	MB89V201	MB89F202RA *	MB89202/R
12bit x 1	8bit x 1	-	-	1	-	1 / 1	-	-	-	-	Buzzer output	MB89V201	MB89F202RAY *	MB89202/R
12bit x 1	8bit x 1	-	-	1	-	1 / 1	-	-	-	-	Buzzer output	MB89V201	MB89F202Y	MB89202/R
-	8bit x 1	8bit x 2	-	2	-	2 / -	-	-	-	-	-	MB89PV470	MB89475	MB89470
-	8bit x 1	8bit x 2	-	2	-	2 / -	-	-	-	-	-	MB89PV470	MB89P475	MB89470
6bit x 1	8bit x 1	8bit x 1	-	1	-	1 / -	-	31 x 4	-	-	-	MB89PV480	MB89485	MB89480
6bit x 1	8bit x 1	8bit x 1	-	1	-	1 / -	-	31 x 4	-	-	-	MB89PV480	MB89485L	MB89480
6bit x 1	8bit x 1	8bit x 1	-	1	-	1 / -	-	31 x 4	-	-	-	MB89PV480	MB89P485	MB89480
6bit x 1	8bit x 1	8bit x 1	-	1	-	1 / -	-	31 x 4	-	-	-	MB89PV480	MB89P485L	MB89480
-	8bit x 2	-	-	2	1	1 / 1	-	32 x 4	-	-	-	MB89PV490	MB89498	MB89490
-	8bit x 2	-	-	2	1	1 / 1	-	32 x 4	-	-	-	MB89PV490	MB89F499	MB89490
6bit x 1, 12bit x 2	8bit x 2	8bit x 1	-	3	-	2 / 1	-	-	-	-	-	MB89PV530	MB89535A	MB89530A
6bit x 1, 12bit x 2	8bit x 2	8bit x 1	-	3	-	2 / 1	-	-	-	-	-	MB89PV530	MB89537A	MB89530A
6bit x 1, 12bit x 2	8bit x 2	8bit x 1	-	3	1	2 / 1	-	-	-	-	-	MB89PV530	MB89537AC	MB89530A
6bit x 1, 12bit x 2	8bit x 2	8bit x 1	-	3	-	2 / 1	-	-	-	-	-	MB89PV530	MB89538A	MB89530A
6bit x 1, 12bit x 2	8bit x 2	8bit x 1	-	3	1	2 / 1	-	-	-	-	-	MB89PV530	MB89538AC	MB89530A
6bit x 1, 12bit x 2	8bit x 2	8bit x 1	-	3	1	2 / 1	-	-	-	-	-	MB89PV530	MB89F538	MB89530A
6bit x 1, 12bit x 2	8bit x 2	8bit x 1	-	3	1	2 / 1	-	-	-	-	-	MB89PV530	MB89F538L	MB89530A
6bit x 1	8bit x 2	8bit x 1	-	2	-	2 / -	-	32 x 4	-	-	-	MB89PV550A	MB89557A	MB89550A
6bit x 1	8bit x 2	8bit x 1	-	2	-	2 / -	-	32 x 4	-	-	-	MB89PV550A	MB89558A	MB89550A
6bit x 1	8bit x 2	8bit x 1	-	2	-	2 / -	-	32 x 4	-	-	-	MB89PV550A	MB89P558A	MB89550A
6bit x 1, 12bit x 1	8bit x 2	8bit x 1	-	2	-	2 / 1	-	24 x 4	-	-	-	MB89PV560	MB89567A	MB89560/A/H
6bit x 1, 12bit x 1	8bit x 2	8bit x 1	-	2	1	2 / 1	-	24 x 4	-	-	-	MB89PV560	MB89567AC	MB89560/A/H

(Continued)

Microcontrollers (8-bit Proprietary F²MC-8L Family)

Series	Part number	Application	Package [pin]	Operating voltage : V _{CC} [V]	Internal clock frequency [Max., MHz]	Sub-clock	Memory type	ROM [byte]	RAM [byte]	External interrupts [ch.]	External bus	A/D converter [bit x ch.]	D/A converter [bit x ch.]	Timer		
														16-bit timer [ch.]	Output compare [ch.]	Input capture [ch.]
MB89560/A/H	MB89P568	LCD controller	80	3 or 5	12.5	Yes	OTP	48K	1K	12	-	10bit x 8	-	1	-	-
MB89580B/BW	MB89583B	USB	64	3 or 5	12.5	-	MASK	8K	512	8	-	-	-	-	-	-
MB89580B/BW	MB89583BW	USB	64	3 or 5	12.5	-	MASK	8K	512	8	-	-	-	-	-	-
MB89580B/BW	MB89585B	USB	64	3 or 5	12.5	-	MASK	16K	1K	8	-	-	-	-	-	-
MB89580B/BW	MB89585BW	USB	64	3 or 5	12.5	-	MASK	16K	1K	8	-	-	-	-	-	-
MB89580B/BW	MB89589B	USB	64	3 or 5	12.5	-	MASK	16K	18K	8	-	-	-	-	-	-
MB89580B/BW	MB89P585B	USB	64	3 or 5	12.5	-	OTP	16K	1K	8	-	-	-	-	-	-
MB89580B/BW	MB89P585BW	USB	64	3 or 5	12.5	-	OTP	16K	1K	8	-	-	-	-	-	-
MB89580B/BW	MB89P589B	USB	64	3 or 5	12.5	-	OTP	16K	18K	8	-	-	-	-	-	-
MB89630R	MB89635R	Standard	64	3 or 5	10	Yes	MASK	16K	512	4	Yes	10bit x 8	-	1	-	-
MB89630R	MB89636R	Standard	64	3 or 5	10	Yes	MASK	24K	768	4	Yes	10bit x 8	-	1	-	-
MB89630R	MB89637R	Standard	64	3 or 5	10	Yes	MASK	32K	1K	4	Yes	10bit x 8	-	1	-	-
MB89670AR	MB89673AR	Standard	80	3 or 5	10	-	MASK	8K	384	8	Yes	10bit x 8	-	2	-	-
MB89670AR	MB89675AR	Standard	80	3 or 5	10	-	MASK	16K	512	8	Yes	10bit x 8	-	2	-	-
MB89670AR	MB89677AR	Standard	80	3 or 5	10	-	MASK	32K	1K	8	Yes	10bit x 8	-	2	-	-
MB89800	MB89803	LCD controller	100	3 or 5	10	-	MASK	8K	256	2	-	-	-	-	-	-
MB89800	MB89805	LCD controller	100	3 or 5	10	-	MASK	16K	512	2	-	-	-	-	-	-
MB89800	MB89P808	LCD controller	100	3 or 5	10	-	OTP	48K	2K	2	-	-	-	-	-	-
MB89820	MB89821	LCD controller	80	3 or 5	5	-	MASK	4K	128	2	-	-	-	-	-	-
MB89820	MB89823R	LCD controller	80	3 or 5	5	-	MASK	8K	256	2	-	-	-	-	-	-
MB89820	MB89825	LCD controller	80	3 or 5	5	-	MASK	16K	256	2	-	-	-	-	-	-
MB89820	MB89P825	LCD controller	80	3 or 5	5	-	OTP	16K	256	2	-	-	-	-	-	-
MB89860	MB89865	Inverter control	80	3 or 5	10	-	MASK	16K	512	4	Yes	10bit x 8	-	-	8bit x 4	-
MB89860	MB89867	Inverter control	80	3 or 5	10	-	MASK	32K	1K	4	Yes	10bit x 8	-	-	8bit x 4	-
MB89860	MB89P867	Inverter control	80	3 or 5	10	-	OTP	32K	1K	4	Yes	10bit x 8	-	-	8bit x 4	-
MB89890	MB89898	Standard	100	3 or 5	8	Yes	MASK	48K	1.5K	16	-	8bit x 8	-	1	-	-
MB89890	MB89899	Standard	100	3 or 5	8	Yes	MASK	60K	2K	16	-	8bit x 8	-	1	-	-
MB89890	MB89P899	Standard	100	3 or 5	8	Yes	OTP	60K	2K	16	-	8bit x 8	-	1	-	-
MB89920	MB89923	LCD controller	80	3 or 5	8	-	MASK	8K	256	4	-	10bit x 8	-	-	16bit x 2	16bit x 2
MB89920	MB89925	LCD controller	80	3 or 5	8	-	MASK	16K	512	4	-	10bit x 8	-	-	16bit x 2	16bit x 2
MB89920	MB89P928	LCD controller	80	3 or 5	8	-	OTP	48K	1K	4	-	10bit x 8	-	-	16bit x 2	16bit x 2
MB89930B	MB89935B	Standard	30	3 or 5	10	-	MASK	16K	512	11	-	10bit x 8	-	1	-	-
MB89930B	MB89P935B	Standard	30	3 or 5	10	-	OTP	16K	512	11	-	10bit x 8	-	1	-	-
MB89940	MB89943	LCD controller	48	5	8	-	MASK	8K	512	3	-	10bit x 2	-	1	-	-
MB89940	MB89945	LCD controller	48	5	8	-	MASK	16K	512	3	-	10bit x 2	-	1	-	-
MB89940	MB89P945	LCD controller	48	5	8	-	OTP	16K	512	3	-	10bit x 2	-	1	-	-
MB89980	MB89983	Standard	64	3 or 5	4.2	Yes	MASK	8K	256	12	-	8bit x 4	-	1	-	-
MB89980	MB89P985	Standard	64	3 or 5	4.2	Yes	OTP	16K	512	12	-	8bit x 4	-	1	-	-

Microcontrollers (8-bit Proprietary F²MC-8L Family)

Timer				Serial			Commu- nication	LCD controller [seg. x com.]	Invert er	VFD	Functions	Evaluation device	Part number	Series
PPG timer [ch.]	PWM timer [ch.]	PWC timer [ch.]	Up/ Down counter [ch.]	[ch.]	PC [ch.]	UART/ SIO [ch.]	USB- Function [ch.]							
6bit x 1, 12bit x 1	8bit x 2	8bit x 1	-	2	1	2 / 1	-	24 x 4	-	-	-	MB89PV560	MB89P568	MB89560/A/H
-	8bit x 2	-	-	1	-	1 / -	1	-	-	-	-	MB89P585B	MB89583B	MB89580B/BW
-	8bit x 2	-	-	1	-	1 / -	1	-	-	-	-	MB89P585BW	MB89583BW	MB89580B/BW
-	8bit x 2	-	-	1	-	1 / -	1	-	-	-	-	MB89P585B	MB89585B	MB89580B/BW
-	8bit x 2	-	-	1	-	1 / -	1	-	-	-	-	MB89P585BW	MB89585BW	MB89580B/BW
-	8bit x 2	-	-	1	-	1 / -	1	-	-	-	-	MB89P589B	MB89589B	MB89580B/BW
-	8bit x 2	-	-	1	-	1 / -	1	-	-	-	-	MB89P585B	MB89P585B	MB89580B/BW
-	8bit x 2	-	-	1	-	1 / -	1	-	-	-	-	MB89P585BW	MB89P585BW	MB89580B/BW
-	8bit x 2	-	-	1	-	1 / -	1	-	-	-	-	MB89P589B	MB89P589B	MB89580B/BW
-	8bit x 2	8bit x 1	-	3	-	2 / 1	-	-	-	-	-	MB89PV630	MB89635R	MB89630R
-	8bit x 2	8bit x 1	-	3	-	2 / 1	-	-	-	-	-	MB89PV630	MB89636R	MB89630R
-	8bit x 2	8bit x 1	-	3	-	2 / 1	-	-	-	-	-	MB89PV630	MB89637R	MB89630R
-	8bit x 6	-	16bit x 1	2	-	1 / 1	-	-	-	-	-	MB89PV670A	MB89673AR	MB89670AR
-	8bit x 6	-	16bit x 1	2	-	1 / 1	-	-	-	-	-	MB89PV670A	MB89675AR	MB89670AR
-	8bit x 6	-	16bit x 1	2	-	1 / 1	-	-	-	-	-	MB89PV670A	MB89677AR	MB89670AR
-	8bit x 1	-	-	1	-	1 / 1	-	70 x 4	-	-	-	MB89PV800	MB89803	MB89800
-	8bit x 1	8bit x 1	-	1	-	1 / 1	-	70 x 4	-	-	-	MB89PV800	MB89805	MB89800
-	8bit x 1	8bit x 1	-	1	-	1 / 1	-	70 x 4	-	-	-	MB89PV800	MB89P808	MB89800
-	8bit x 1	8bit x 1	-	1	-	1 / 1	-	50 x 4	-	-	DTMF Generator	MB89PV820	MB89821	MB89820
-	8bit x 1	8bit x 1	-	1	-	1 / 1	-	50 x 4	-	-	DTMF Generator	MB89PV820	MB89823R	MB89820
-	8bit x 1	8bit x 1	-	1	-	1 / 1	-	50 x 4	-	-	DTMF Generator	MB89PV820	MB89825	MB89820
-	8bit x 1	8bit x 1	-	1	-	1 / 1	-	50 x 4	-	-	DTMF Generator	MB89PV820	MB89P825	MB89820
-	8bit x 2	-	10bit x 1	2	-	1 / 1	-	-	Yes	-	-	MB89P867	MB89865	MB89860
-	8bit x 2	-	10bit x 1	2	-	1 / 1	-	-	Yes	-	-	MB89P867	MB89867	MB89860
-	8bit x 2	-	10bit x 1	2	-	1 / 1	-	-	Yes	-	-	MB89P867	MB89P867	MB89860
-	8bit x 1	-	-	1	-	- / 1	-	-	-	-	DTMF Generator	MB89PV890	MB89898	MB89890
-	8bit x 1	-	-	1	-	- / 1	-	-	-	-	DTMF Generator	MB89PV890	MB89899	MB89890
-	8bit x 1	-	-	1	-	- / 1	-	-	-	-	DTMF Generator	MB89PV890	MB89P899	MB89890
-	8bit x 2	-	-	2	-	1 / 1	-	24 x 4	-	-	Low Volt. Detection Reset	MB89PV920	MB89923	MB89920
-	8bit x 2	-	-	2	-	1 / 1	-	24 x 4	-	-	Low Volt. Detection Reset	MB89PV920	MB89925	MB89920
-	8bit x 2	-	-	2	-	1 / 1	-	24 x 4	-	-	Low Volt. Detection Reset	MB89PV920	MB89P928	MB89920
12bit x 1	8bit x 1	-	-	1	-	1 / 1	-	-	-	-	-	MB89PV930A	MB89935B	MB89930B
12bit x 1	8bit x 1	-	-	1	-	1 / 1	-	-	-	-	-	MB89PV930A	MB89P935B	MB89930B
-	8bit x 2	-	-	-	-	-	-	17 x 4	-	-	Stepping motor controller x 2ch. Low Volt. Detection Reset Ext.Volt. Monitor Int.	MB89PV940	MB89943	MB89940
-	8bit x 2	-	-	-	-	-	-	17 x 4	-	-	Stepping motor controller x 2ch. Low Volt. Detection Reset Ext.Volt. Monitor Int.	MB89PV940	MB89945	MB89940
-	8bit x 2	-	-	-	-	-	-	17 x 4	-	-	Stepping motor controller x 2ch. Low Volt. Detection Reset Ext.Volt. Monitor Int.	MB89PV940	MB89P945	MB89940
-	8bit x 2	-	-	-	-	-	-	-	-	-	Remote-controller carrier generator Buzzer output	MB89PV980	MB89983	MB89980
-	8bit x 2	-	-	-	-	-	-	-	-	-	Remote-controller carrier generator Buzzer output	MB89PV980	MB89P985	MB89980

Microcontrollers (8-bit Proprietary F²MC-8FX Family)

Microcontrollers (8-bit Proprietary F²MC-8FX Family)

Series	Part number	Aprication	Package [pin]	Operating voltage : V _{CC} [V]	Internal clock frequency [Max., MHz]	Sub-clock	Memory type	ROM [byte]	RAM [byte]	External interrupts [ch.]	A/D converter [bit x ch.]	Timer	
												16-bit timer [ch.]	Input capture [ch.]
MB95100AM	MB95108AM	Standard	64	5	16	Yes	MASK	60K	2K	12	10bit x 12	3	Yes
MB95100AM	MB95F104AJ	Standard	64	5	16	Yes	Dual Op. Flash	16K	0.5K	12	10bit x 12	3	Yes
MB95100AM	MB95F106AJ	Standard	64	5	16	Yes	Dual Op. Flash	32K	1K	12	10bit x 12	3	Yes
MB95100AM	MB95F108AM	Standard	64	5	16	Yes	Dual Op. Flash	60K	2K	12	10bit x 12	3	Yes
MB95100B	MB95107B	Standard	64	3	16	Yes	MASK	48K	2K	12	10bit x 12	3	Yes
MB95100B	MB95F108B	Standard	64	3	16	Yes	Dual Op. Flash	60K	2K	12	10bit x 12	3	Yes
MB95110B	MB95116B *	Standard	48/52	3	16	Yes	MASK	32K	1K	8	10bit x 8	2	-
MB95110B	MB95F118B	Standard	48/52	3	16	Yes	Dual Op. Flash	60K	2K	8	10bit x 8	2	-
MB95110M	MB95117M *	Standard	52	5	16	Yes	MASK	48K	2K	8	10bit x 8	2	-
MB95110M	MB95F114J	Standard	52	5	16	Yes	Dual Op. Flash	16K	0.5K	8	10bit x 8	2	-
MB95110M	MB95F116J	Standard	52	5	16	Yes	Dual Op. Flash	32K	1K	8	10bit x 8	2	-
MB95110M	MB95F118M	Standard	52	5	16	Yes	Dual Op. Flash	60K	2K	8	10bit x 8	2	-
MB95120	MB95F128D	LCD controller	100	5	16	Yes	Dual Op. Flash	60K	2K	12	10bit x 12	3	Yes
MB95120MB	MB95128MB	LCD controller	100	5	16	Yes	MASK	60K	2K	12	10bit x 12	3	Yes
MB95120MB	MB95F124MB	LCD controller	100	5	16	Yes	Dual Op. Flash	16K	0.5K	12	10bit x 12	3	Yes
MB95120MB	MB95F126MB	LCD controller	100	5	16	Yes	Dual Op. Flash	32K	1K	12	10bit x 12	3	Yes
MB95120MB	MB95F128MB	LCD controller	100	5	16	Yes	Dual Op. Flash	60K	2K	12	10bit x 12	3	Yes
MB95130MB	MB95136MB	Standard	28	5	16	Yes	MASK	32K	1K	8	10bit x 8	1	-
MB95130MB	MB95F133J	Standard	28	5	16	Yes	FLASH	8K	0.25K	8	10bit x 8	1	-
MB95130MB	MB95F134J	Standard	28	5	16	Yes	FLASH	16K	0.5K	8	10bit x 8	1	-
MB95130MB	MB95F136MB	Standard	28	5	16	Yes	FLASH	32K	1K	8	10bit x 8	1	-
MB95140	MB95F146 *	Standard	32	3	16	Yes	FLASH	32K	1K	8	10bit x 8	1	-
MB95150M	MB95156M	LCD controller	48/52	5	16	Yes	MASK	32K	1K	8	10bit x 8	1	Yes
MB95150M	MB95F156M	LCD controller	48/52	5	16	Yes	FLASH	32K	1K	8	10bit x 8	1	Yes
MB95160M	MB95F168M	LCD controller	64	5	16	Yes	FLASH	60K	2K	8	10bit x 8	2	Yes

*: Under development

Microcontrollers (8-bit Proprietary F²MC-8FX Family)

Timer			Serial			LCD controller [seg. x com.]	Functions	Evaluation device	Part number	Series
PPG timer [ch.]	PWM timer [ch.]	PWC timer [ch.]	[ch.]	I ² C [ch.]	UART/ SIO [ch.]					
Yes	Yes	Yes	3	1	2 / 2	-	Reload Timer/PPG/PWM/PWC mode selectable	MB95FV100D-103	MB95108AM	MB95100AM
Yes	Yes	Yes	3	1	2 / 2	-	Dual operation Flash Reload Timer/PPG/PWM/PWC mode selectable	MB95FV100D-103	MB95F104AJ	MB95100AM
Yes	Yes	Yes	3	1	2 / 2	-	Dual operation Flash Reload Timer/PPG/PWM/PWC mode selectable	MB95FV100D-103	MB95F106AJ	MB95100AM
Yes	Yes	Yes	3	1	2 / 2	-	Dual operation Flash Reload Timer/PPG/PWM/PWC mode selectable	MB95FV100D-103	MB95F108AM	MB95100AM
Yes	Yes	Yes	3	1	2 / 2	-	Reload Timer/PPG/PWM/PWC mode selectable	MB95FV100D-101	MB95107B	MB95100B
Yes	Yes	Yes	3	1	2 / 2	-	Dual operation Flash Reload Timer/PPG/PWM/PWC mode selectable	MB95FV100D-101	MB95F108B	MB95100B
16bit x 3	-	-	3	1	2 / 2	-	-	MB95FV100D-101	MB95116B *	MB95110B
16bit x 3	-	-	3	1	2 / 2	-	Dual operation Flash	MB95FV100D-101	MB95F118B	MB95110B
16bit x 3	-	-	3	1	2 / 2	-	-	MB95FV100D-103	MB95117M *	MB95110M
16bit x 3	-	-	3	1	2 / 2	-	Dual operation Flash	MB95FV100D-103	MB95F114J	MB95110M
16bit x 3	-	-	3	1	2 / 2	-	Dual operation Flash	MB95FV100D-103	MB95F116J	MB95110M
16bit x 3	-	-	3	1	2 / 2	-	Dual operation Flash	MB95FV100D-103	MB95F118M	MB95110M
Yes	Yes	Yes	3	1	2 / 2	40 x 4	Dual operation Flash Reload Timer/PPG/PWM/PWC mode selectable 32bit mode can be used	MB95FV100D-101 MB95FV100D-102	MB95F128D	MB95120
Yes	Yes	Yes	3	1	2 / 2	40 x 4	Reload Timer/PPG/PWM/PWC mode selectable 32bit mode can be used	MB95FV100D-103	MB95128MB	MB95120MB
Yes	Yes	Yes	3	1	2 / 2	40 x 4	Dual operation Flash Reload Timer/PPG/PWM/PWC mode selectable 32bit mode can be used	MB95FV100D-103	MB95F124MB	MB95120MB
Yes	Yes	Yes	3	1	2 / 2	40 x 4	Dual operation Flash Reload Timer/PPG/PWM/PWC mode selectable 32bit mode can be used	MB95FV100D-103	MB95F126MB	MB95120MB
Yes	Yes	Yes	3	1	2 / 2	40 x 4	Dual operation Flash Reload Timer/PPG/PWM/PWC mode selectable 32bit mode can be used	MB95FV100D-103	MB95F128MB	MB95120MB
16bit x 2	-	-	2	-	2 / 2	-	-	MB95FV100D-103	MB95136MB	MB95130MB
16bit x 2	-	-	2	-	2 / 2	-	One sector Flash	MB95FV100D-103	MB95F133J	MB95130MB
16bit x 2	-	-	2	-	2 / 2	-	One sector Flash	MB95FV100D-103	MB95F134J	MB95130MB
16bit x 2	-	-	2	-	2 / 2	-	One sector Flash	MB95FV100D-103	MB95F136MB	MB95130MB
16bit x 2	-	-	2	-	2 / 2	-	One sector Flash	MB95FV100D-101	MB95F146 *	MB95140
Yes	Yes	Yes	2	-	2 / 2	16 x 4	Reload Timer/PPG/PWM/PWC mode selectable 32bit mode can be used	MB95FV100D-103	MB95156M	MB95150M
Yes	Yes	Yes	2	-	2 / 2	16 x 4	One sector Flash Reload Timer/PPG/PWM/PWC mode selectable 32bit mode can be used	MB95FV100D-103	MB95F156M	MB95150M
Yes	Yes	Yes	3	1	2 / 2	32 x 4	One sector Flash Reload Timer/PPG/PWM/PWC mode selectable 32bit mode can be used	MB95FV100D-103	MB95F168M	MB95160M

Microcontrollers (16-bit Proprietary F²MC-16LX Family)

Microcontrollers (16-bit Proprietary F²MC-16LX Family)

Series	Part number	Application	Package [pin]	Operating voltage : V _{CC} [V]	Internal clock frequency [Max., MHz]	Sub-clock	Memory type	ROM [byte]	RAM [byte]	DMAC [ch.]	External interrupts [ch.]	External bus	A/D converter [bit x ch.]	D/A converter [bit x ch.]	Timer		
															16-bit timer [ch.]	Output compare [ch.]	PPG timer [ch.]
MB90330A	MB90333A	USB	120	3	24	Yes	MASK	256K	16K	16	8	Yes	10bit x 16	-	3	16bit x 4	16bit x 4
MB90330A	MB90F334A	USB	120	3	24	Yes	FLASH	384K	24K	16	8	Yes	10bit x 16	-	3	16bit x 4	16bit x 4
MB90335	MB90337	USB	64	3	24	-	MASK	64K	4K	16	8	-	-	-	3	16bit x 4	16bit x 4
MB90335	MB90F337	USB	64	3	24	-	Dual Op. Flash	64K	4K	16	8	-	-	-	3	16bit x 4	16bit x 4
MB90340E	MB90341CE	CAN	100	5	24	Yes	MASK	128K	16K	16	16	Yes	10bit x 24	-	4	16bit x 8	16bit x 8
MB90340E	MB90341CES	CAN	100	5	24	-	MASK	128K	16K	16	16	Yes	10bit x 24	-	4	16bit x 8	16bit x 8
MB90340E	MB90341E	CAN	100	5	24	Yes	MASK	128K	16K	16	16	Yes	10bit x 16	-	4	16bit x 8	16bit x 8
MB90340E	MB90341ES	CAN	100	5	24	-	MASK	128K	16K	16	16	Yes	10bit x 16	-	4	16bit x 8	16bit x 8
MB90340E	MB90342CE	CAN	100	5	24	Yes	MASK	256K	16K	16	16	Yes	10bit x 24	-	4	16bit x 8	16bit x 8
MB90340E	MB90342CES	CAN	100	5	24	-	MASK	256K	16K	16	16	Yes	10bit x 24	-	4	16bit x 8	16bit x 8
MB90340E	MB90342E	CAN	100	5	24	Yes	MASK	256K	16K	16	16	Yes	10bit x 16	-	4	16bit x 8	16bit x 8
MB90340E	MB90342ES	CAN	100	5	24	-	MASK	256K	16K	16	16	Yes	10bit x 16	-	4	16bit x 8	16bit x 8
MB90340E	MB90346CE	CAN	100	5	24	Yes	MASK	64K	2K	16	16	Yes	10bit x 24	-	4	16bit x 8	16bit x 8
MB90340E	MB90346CES	CAN	100	5	24	-	MASK	64K	2K	16	16	Yes	10bit x 24	-	4	16bit x 8	16bit x 8
MB90340E	MB90346E	CAN	100	5	24	Yes	MASK	64K	2K	16	16	Yes	10bit x 16	-	4	16bit x 8	16bit x 8
MB90340E	MB90346ES	CAN	100	5	24	-	MASK	64K	2K	16	16	Yes	10bit x 16	-	4	16bit x 8	16bit x 8
MB90340E	MB90347CE	CAN	100	5	24	Yes	MASK	128K	6K	16	16	Yes	10bit x 24	-	4	16bit x 8	16bit x 8
MB90340E	MB90347CES	CAN	100	5	24	-	MASK	128K	6K	16	16	Yes	10bit x 24	-	4	16bit x 8	16bit x 8
MB90340E	MB90347E	CAN	100	5	24	Yes	MASK	128K	6K	16	16	Yes	10bit x 16	-	4	16bit x 8	16bit x 8
MB90340E	MB90347ES	CAN	100	5	24	-	MASK	128K	6K	16	16	Yes	10bit x 16	-	4	16bit x 8	16bit x 8
MB90340E	MB90348CE	CAN	100	5	24	Yes	MASK	128K	16K	16	16	Yes	10bit x 24	-	4	16bit x 8	16bit x 8
MB90340E	MB90348CES	CAN	100	5	24	-	MASK	128K	16K	16	16	Yes	10bit x 24	-	4	16bit x 8	16bit x 8
MB90340E	MB90348E	CAN	100	5	24	Yes	MASK	128K	16K	16	16	Yes	10bit x 16	-	4	16bit x 8	16bit x 8
MB90340E	MB90348ES	CAN	100	5	24	-	MASK	128K	16K	16	16	Yes	10bit x 16	-	4	16bit x 8	16bit x 8
MB90340E	MB90349CE	CAN	100	5	24	Yes	MASK	256K	16K	16	16	Yes	10bit x 24	-	4	16bit x 8	16bit x 8
MB90340E	MB90349CES	CAN	100	5	24	-	MASK	256K	16K	16	16	Yes	10bit x 24	-	4	16bit x 8	16bit x 8
MB90340E	MB90349E	CAN	100	5	24	Yes	MASK	256K	16K	16	16	Yes	10bit x 16	-	4	16bit x 8	16bit x 8
MB90340E	MB90349ES	CAN	100	5	24	-	MASK	256K	16K	16	16	Yes	10bit x 16	-	4	16bit x 8	16bit x 8
MB90340E	MB90F342CE	CAN	100	5	24	Yes	FLASH	256K	16K	16	16	Yes	10bit x 24	-	4	16bit x 8	16bit x 8
MB90340E	MB90F342CES	CAN	100	5	24	-	FLASH	256K	16K	16	16	Yes	10bit x 24	-	4	16bit x 8	16bit x 8
MB90340E	MB90F342E	CAN	100	5	24	Yes	FLASH	256K	16K	16	16	Yes	10bit x 16	-	4	16bit x 8	16bit x 8
MB90340E	MB90F342ES	CAN	100	5	24	-	FLASH	256K	16K	16	16	Yes	10bit x 16	-	4	16bit x 8	16bit x 8
MB90340E	MB90F343CE	CAN	100	5	24	Yes	FLASH	384K	20K	16	16	Yes	10bit x 24	-	4	16bit x 8	16bit x 8
MB90340E	MB90F343CES	CAN	100	5	24	-	FLASH	384K	20K	16	16	Yes	10bit x 24	-	4	16bit x 8	16bit x 8
MB90340E	MB90F343E	CAN	100	5	24	Yes	FLASH	384K	20K	16	16	Yes	10bit x 16	-	4	16bit x 8	16bit x 8
MB90340E	MB90F343ES	CAN	100	5	24	-	FLASH	384K	20K	16	16	Yes	10bit x 16	-	4	16bit x 8	16bit x 8
MB90340E	MB90F345CE	CAN	100	5	24	Yes	FLASH	512K	20K	16	16	Yes	10bit x 24	-	4	16bit x 8	16bit x 8
MB90340E	MB90F345CES	CAN	100	5	24	-	FLASH	512K	20K	16	16	Yes	10bit x 24	-	4	16bit x 8	16bit x 8
MB90340E	MB90F345E	CAN	100	5	24	Yes	FLASH	512K	20K	16	16	Yes	10bit x 16	-	4	16bit x 8	16bit x 8
MB90340E	MB90F345ES	CAN	100	5	24	-	FLASH	512K	20K	16	16	Yes	10bit x 16	-	4	16bit x 8	16bit x 8
MB90340E	MB90F346CE	CAN	100	5	24	Yes	FLASH	64K	2K	16	16	Yes	10bit x 24	-	4	16bit x 8	16bit x 8
MB90340E	MB90F346CES	CAN	100	5	24	-	FLASH	64K	2K	16	16	Yes	10bit x 24	-	4	16bit x 8	16bit x 8
MB90340E	MB90F346E	CAN	100	5	24	Yes	FLASH	64K	2K	16	16	Yes	10bit x 16	-	4	16bit x 8	16bit x 8
MB90340E	MB90F346ES	CAN	100	5	24	-	FLASH	64K	2K	16	16	Yes	10bit x 16	-	4	16bit x 8	16bit x 8
MB90340E	MB90F347CE	CAN	100	5	24	Yes	FLASH	128K	6K	16	16	Yes	10bit x 24	-	4	16bit x 8	16bit x 8
MB90340E	MB90F347CES	CAN	100	5	24	-	FLASH	128K	6K	16	16	Yes	10bit x 24	-	4	16bit x 8	16bit x 8
MB90340E	MB90F347E	CAN	100	5	24	Yes	FLASH	128K	6K	16	16	Yes	10bit x 16	-	4	16bit x 8	16bit x 8
MB90340E	MB90F347ES	CAN	100	5	24	-	FLASH	128K	6K	16	16	Yes	10bit x 16	-	4	16bit x 8	16bit x 8
MB90340E	MB90F349CE	CAN	100	5	24	Yes	FLASH	256K	16K	16	16	Yes	10bit x 24	-	4	16bit x 8	16bit x 8
MB90340E	MB90F349CES	CAN	100	5	24	-	FLASH	256K	16K	16	16	Yes	10bit x 24	-	4	16bit x 8	16bit x 8
MB90340E	MB90F349E	CAN	100	5	24	Yes	FLASH	256K	16K	16	16	Yes	10bit x 16	-	4	16bit x 8	16bit x 8
MB90340E	MB90F349ES	CAN	100	5	24	-	FLASH	256K	16K	16	16	Yes	10bit x 16	-	4	16bit x 8	16bit x 8
MB90350E	MB90351E	CAN	64	5	24	Yes	MASK	64K	4K	16	8	Yes	10bit x 15	-	4	16bit x 4	16bit x 6
MB90350E	MB90351ES	CAN	64	5	24	-	MASK	64K	4K	16	8	Yes	10bit x 15	-	4	16bit x 4	16bit x 6
MB90350E	MB90351TE	CAN	64	5	24	Yes	MASK	64K	4K	16	8	Yes	10bit x 15	-	4	16bit x 4	16bit x 6
MB90350E	MB90351TES	CAN	64	5	24	-	MASK	64K	4K	16	8	Yes	10bit x 15	-	4	16bit x 4	16bit x 6
MB90350E	MB90352E	CAN	64	5	24	Yes	MASK	128K	4K	16	8	Yes	10bit x 15	-	4	16bit x 4	16bit x 6
MB90350E	MB90352ES	CAN	64	5	24	-	MASK	128K	4K	16	8	Yes	10bit x 15	-	4	16bit x 4	16bit x 6
MB90350E	MB90352TE	CAN	64	5	24	Yes	MASK	128K	4K	16	8	Yes	10bit x 15	-	4	16bit x 4	16bit x 6
MB90350E	MB90352TES	CAN	64	5	24	-	MASK	128K	4K	16	8	Yes	10bit x 15	-	4	16bit x 4	16bit x 6

Microcontrollers (16-bit Proprietary F²MC-16LX Family)

Timer			Serial			Communication			IE bus [ch.]	LCD controller [seg. x com.]	Inverter	VFD	Functions	Evaluation device	Part number	Series
Input capture [ch.]	PWC timer [ch.]	Up/Down counter [ch.]	[ch.]	I ² C [ch.]	UART/SIO [ch.]	CAN [ch.]	USB-Host [ch.]	USB-Function [ch.]								
16bit x 3	16bit x 1	-	5	3	4/1	-	1	1	-	-	-	-	-	MB90V330A	MB90333A	MB90330A
16bit x 3	16bit x 1	-	5	3	4/1	-	1	1	-	-	-	-	-	MB90V330A	MB90F334A	MB90330A
16bit x 3	16bit x 1	-	3	1	2/1	-	1	1	-	-	-	-	-	MB90V330A	MB90337	MB90335
16bit x 3	16bit x 1	-	3	1	2/1	-	1	1	-	-	-	-	Dual operation Flash	MB90V330A	MB90F337	MB90335
16bit x 8	-	-	4	2	4/-	2	-	-	-	-	-	-	LIN	MB90V340E-102	MB90341CE	MB90340E
16bit x 8	-	-	4	2	4/-	2	-	-	-	-	-	-	LIN	MB90V340E-101	MB90341CES	MB90340E
16bit x 8	-	-	4	-	4/-	2	-	-	-	-	-	-	LIN	MB90V340E-102	MB90341E	MB90340E
16bit x 8	-	-	4	-	4/-	2	-	-	-	-	-	-	LIN	MB90V340E-101	MB90341ES	MB90340E
16bit x 8	-	-	4	2	4/-	2	-	-	-	-	-	-	LIN	MB90V340E-102	MB90342CE	MB90340E
16bit x 8	-	-	4	2	4/-	2	-	-	-	-	-	-	LIN	MB90V340E-101	MB90342CES	MB90340E
16bit x 8	-	-	4	-	4/-	2	-	-	-	-	-	-	LIN	MB90V340E-102	MB90342E	MB90340E
16bit x 8	-	-	4	-	4/-	2	-	-	-	-	-	-	LIN	MB90V340E-101	MB90342ES	MB90340E
16bit x 8	-	-	4	2	4/-	1	-	-	-	-	-	-	LIN	MB90V340E-102	MB90346CE	MB90340E
16bit x 8	-	-	4	2	4/-	1	-	-	-	-	-	-	LIN	MB90V340E-101	MB90346CES	MB90340E
16bit x 8	-	-	4	-	4/-	1	-	-	-	-	-	-	LIN	MB90V340E-102	MB90346E	MB90340E
16bit x 8	-	-	4	-	4/-	1	-	-	-	-	-	-	LIN	MB90V340E-101	MB90346ES	MB90340E
16bit x 8	-	-	4	2	4/-	1	-	-	-	-	-	-	LIN	MB90V340E-102	MB90347CE	MB90340E
16bit x 8	-	-	4	2	4/-	1	-	-	-	-	-	-	LIN	MB90V340E-101	MB90347CES	MB90340E
16bit x 8	-	-	4	-	4/-	1	-	-	-	-	-	-	LIN	MB90V340E-102	MB90347E	MB90340E
16bit x 8	-	-	4	-	4/-	1	-	-	-	-	-	-	LIN	MB90V340E-101	MB90347ES	MB90340E
16bit x 8	-	-	4	2	4/-	1	-	-	-	-	-	-	LIN	MB90V340E-102	MB90348CE	MB90340E
16bit x 8	-	-	4	2	4/-	1	-	-	-	-	-	-	LIN	MB90V340E-101	MB90348CES	MB90340E
16bit x 8	-	-	4	-	4/-	1	-	-	-	-	-	-	LIN	MB90V340E-102	MB90348E	MB90340E
16bit x 8	-	-	4	-	4/-	1	-	-	-	-	-	-	LIN	MB90V340E-101	MB90348ES	MB90340E
16bit x 8	-	-	4	2	4/-	1	-	-	-	-	-	-	LIN	MB90V340E-102	MB90349CE	MB90340E
16bit x 8	-	-	4	2	4/-	1	-	-	-	-	-	-	LIN	MB90V340E-101	MB90349CES	MB90340E
16bit x 8	-	-	4	-	4/-	1	-	-	-	-	-	-	LIN	MB90V340E-102	MB90349E	MB90340E
16bit x 8	-	-	4	-	4/-	1	-	-	-	-	-	-	LIN	MB90V340E-101	MB90349ES	MB90340E
16bit x 8	-	-	4	2	4/-	2	-	-	-	-	-	-	LIN	MB90V340E-102	MB90F342CE	MB90340E
16bit x 8	-	-	4	2	4/-	2	-	-	-	-	-	-	LIN	MB90V340E-101	MB90F342CES	MB90340E
16bit x 8	-	-	4	-	4/-	2	-	-	-	-	-	-	LIN	MB90V340E-102	MB90F342E	MB90340E
16bit x 8	-	-	4	-	4/-	2	-	-	-	-	-	-	LIN	MB90V340E-101	MB90F342ES	MB90340E
16bit x 8	-	-	4	2	4/-	2	-	-	-	-	-	-	LIN	MB90V340E-102	MB90F343CE	MB90340E
16bit x 8	-	-	4	2	4/-	2	-	-	-	-	-	-	LIN	MB90V340E-101	MB90F343CES	MB90340E
16bit x 8	-	-	4	-	4/-	2	-	-	-	-	-	-	LIN	MB90V340E-102	MB90F343E	MB90340E
16bit x 8	-	-	4	-	4/-	2	-	-	-	-	-	-	LIN	MB90V340E-101	MB90F343ES	MB90340E
16bit x 8	-	-	4	2	4/-	2	-	-	-	-	-	-	LIN	MB90V340E-102	MB90F345CE	MB90340E
16bit x 8	-	-	4	2	4/-	2	-	-	-	-	-	-	LIN	MB90V340E-101	MB90F345CES	MB90340E
16bit x 8	-	-	4	-	4/-	2	-	-	-	-	-	-	LIN	MB90V340E-102	MB90F345E	MB90340E
16bit x 8	-	-	4	-	4/-	2	-	-	-	-	-	-	LIN	MB90V340E-101	MB90F345ES	MB90340E
16bit x 8	-	-	4	2	4/-	1	-	-	-	-	-	-	LIN	MB90V340E-102	MB90F346CE	MB90340E
16bit x 8	-	-	4	2	4/-	1	-	-	-	-	-	-	LIN	MB90V340E-101	MB90F346CES	MB90340E
16bit x 8	-	-	4	-	4/-	1	-	-	-	-	-	-	LIN	MB90V340E-102	MB90F346E	MB90340E
16bit x 8	-	-	4	-	4/-	1	-	-	-	-	-	-	LIN	MB90V340E-101	MB90F346ES	MB90340E
16bit x 8	-	-	4	2	4/-	1	-	-	-	-	-	-	LIN	MB90V340E-102	MB90F347CE	MB90340E
16bit x 8	-	-	4	2	4/-	1	-	-	-	-	-	-	LIN	MB90V340E-101	MB90F347CES	MB90340E
16bit x 8	-	-	4	-	4/-	1	-	-	-	-	-	-	LIN	MB90V340E-102	MB90F347E	MB90340E
16bit x 8	-	-	4	-	4/-	1	-	-	-	-	-	-	LIN	MB90V340E-101	MB90F347ES	MB90340E
16bit x 8	-	-	4	2	4/-	1	-	-	-	-	-	-	LIN	MB90V340E-102	MB90F349CE	MB90340E
16bit x 8	-	-	4	2	4/-	1	-	-	-	-	-	-	LIN	MB90V340E-101	MB90F349CES	MB90340E
16bit x 8	-	-	4	-	4/-	1	-	-	-	-	-	-	LIN	MB90V340E-102	MB90F349E	MB90340E
16bit x 8	-	-	4	-	4/-	1	-	-	-	-	-	-	LIN	MB90V340E-101	MB90F349ES	MB90340E
16bit x 6	-	-	2	1	2/-	1	-	-	-	-	-	-	LIN	MB90V340E-102	MB90351E	MB90350E
16bit x 6	-	-	2	1	2/-	1	-	-	-	-	-	-	LIN	MB90V340E-101	MB90351ES	MB90350E
16bit x 6	-	-	2	1	2/-	1	-	-	-	-	-	-	LIN Low-voltage detection reset	MB90V340E-102	MB90351TE	MB90350E
16bit x 6	-	-	2	1	2/-	1	-	-	-	-	-	-	LIN Low-voltage detection reset	MB90V340E-101	MB90351TES	MB90350E
16bit x 6	-	-	2	1	2/-	1	-	-	-	-	-	-	LIN	MB90V340E-102	MB90352E	MB90350E
16bit x 6	-	-	2	1	2/-	1	-	-	-	-	-	-	LIN	MB90V340E-101	MB90352ES	MB90350E
16bit x 6	-	-	2	1	2/-	1	-	-	-	-	-	-	LIN Low-voltage detection reset	MB90V340E-102	MB90352TE	MB90350E
16bit x 6	-	-	2	1	2/-	1	-	-	-	-	-	-	LIN Low-voltage detection reset	MB90V340E-101	MB90352TES	MB90350E

(Continued)

Microcontrollers (16-bit Proprietary F²MC-16LX Family)

Series	Part number	Aprication	Package [pin]	Operating voltage : V _{cc} [V]	Internal clock frequency [Max., MHz]	Sub-clock	Memory type	ROM [byte]	RAM [byte]	DMAC [ch.]	External interrupts [ch.]	External bus	A/D converter [bit x ch.]	D/A converter [bit x ch.]	Timer		
															16-bit timer [ch.]	Output compare [ch.]	PPG timer [ch.]
MB90350E	MB90356E	CAN	64	5	24	Yes	MASK	64K	4K	16	8	Yes	10bit x 15	-	4	16bit x 4	16bit x 6
MB90350E	MB90356ES	CAN	64	5	24	-	MASK	64K	4K	16	8	Yes	10bit x 15	-	4	16bit x 4	16bit x 6
MB90350E	MB90356TE	CAN	64	5	24	Yes	MASK	64K	4K	16	8	Yes	10bit x 15	-	4	16bit x 4	16bit x 6
MB90350E	MB90356TES	CAN	64	5	24	-	MASK	64K	4K	16	8	Yes	10bit x 15	-	4	16bit x 4	16bit x 6
MB90350E	MB90357E	CAN	64	5	24	Yes	MASK	128K	4K	16	8	Yes	10bit x 15	-	4	16bit x 4	16bit x 6
MB90350E	MB90357ES	CAN	64	5	24	-	MASK	128K	4K	16	8	Yes	10bit x 15	-	4	16bit x 4	16bit x 6
MB90350E	MB90357TE	CAN	64	5	24	Yes	MASK	128K	4K	16	8	Yes	10bit x 15	-	4	16bit x 4	16bit x 6
MB90350E	MB90357TES	CAN	64	5	24	-	MASK	128K	4K	16	8	Yes	10bit x 15	-	4	16bit x 4	16bit x 6
MB90350E	MB90F351E	CAN	64	5	24	Yes	FLASH	64K	4K	16	8	Yes	10bit x 15	-	4	16bit x 4	16bit x 6
MB90350E	MB90F351ES	CAN	64	5	24	-	FLASH	64K	4K	16	8	Yes	10bit x 15	-	4	16bit x 4	16bit x 6
MB90350E	MB90F351TE	CAN	64	5	24	Yes	FLASH	64K	4K	16	8	Yes	10bit x 15	-	4	16bit x 4	16bit x 6
MB90350E	MB90F351TES	CAN	64	5	24	-	FLASH	64K	4K	16	8	Yes	10bit x 15	-	4	16bit x 4	16bit x 6
MB90350E	MB90F352E	CAN	64	5	24	Yes	Dual Op. Flash	128K	4K	16	8	Yes	10bit x 15	-	4	16bit x 4	16bit x 6
MB90350E	MB90F352ES	CAN	64	5	24	-	Dual Op. Flash	128K	4K	16	8	Yes	10bit x 15	-	4	16bit x 4	16bit x 6
MB90350E	MB90F352TE	CAN	64	5	24	Yes	Dual Op. Flash	128K	4K	16	8	Yes	10bit x 15	-	4	16bit x 4	16bit x 6
MB90350E	MB90F352TES	CAN	64	5	24	-	Dual Op. Flash	128K	4K	16	8	Yes	10bit x 15	-	4	16bit x 4	16bit x 6
MB90350E	MB90F356E	CAN	64	5	24	Yes	Flash	64K	4K	16	8	Yes	10bit x 15	-	4	16bit x 4	16bit x 6
MB90350E	MB90F356ES	CAN	64	5	24	-	Flash	64K	4K	16	8	Yes	10bit x 15	-	4	16bit x 4	16bit x 6
MB90350E	MB90F356TE	CAN	64	5	24	Yes	Flash	64K	4K	16	8	Yes	10bit x 15	-	4	16bit x 4	16bit x 6
MB90350E	MB90F356TES	CAN	64	5	24	-	Flash	64K	4K	16	8	Yes	10bit x 15	-	4	16bit x 4	16bit x 6
MB90350E	MB90F357E	CAN	64	5	24	Yes	Dual Op. Flash	128K	4K	16	8	Yes	10bit x 15	-	4	16bit x 4	16bit x 6
MB90350E	MB90F357ES	CAN	64	5	24	-	Dual Op. Flash	128K	4K	16	8	Yes	10bit x 15	-	4	16bit x 4	16bit x 6
MB90350E	MB90F357TE	CAN	64	5	24	Yes	Dual Op. Flash	128K	4K	16	8	Yes	10bit x 15	-	4	16bit x 4	16bit x 6
MB90350E	MB90F357TES	CAN	64	5	24	-	Dual Op. Flash	128K	4K	16	8	Yes	10bit x 15	-	4	16bit x 4	16bit x 6
MB90360E	MB90362E	CAN	48	5	24	Yes	MASK	64K	3K	-	8	-	10bit x 16	-	2	-	16bit x 4
MB90360E	MB90362ES	CAN	48	5	24	-	MASK	64K	3K	-	8	-	10bit x 16	-	2	-	16bit x 4
MB90360E	MB90362TE	CAN	48	5	24	Yes	MASK	64K	3K	-	8	-	10bit x 16	-	2	-	16bit x 4
MB90360E	MB90362TES	CAN	48	5	24	-	MASK	64K	3K	-	8	-	10bit x 16	-	2	-	16bit x 4
MB90360E	MB90367E	CAN	48	5	24	Yes	MASK	64K	3K	-	8	-	10bit x 16	-	2	-	16bit x 4
MB90360E	MB90367ES	CAN	48	5	24	-	MASK	64K	3K	-	8	-	10bit x 16	-	2	-	16bit x 4
MB90360E	MB90367TE	CAN	48	5	24	Yes	MASK	64K	3K	-	8	-	10bit x 16	-	2	-	16bit x 4
MB90360E	MB90367TES	CAN	48	5	24	-	MASK	64K	3K	-	8	-	10bit x 16	-	2	-	16bit x 4
MB90360E	MB90F362E	CAN	48	5	24	Yes	FLASH	64K	3K	-	8	-	10bit x 16	-	2	-	16bit x 4
MB90360E	MB90F362ES	CAN	48	5	24	-	FLASH	64K	3K	-	8	-	10bit x 16	-	2	-	16bit x 4
MB90360E	MB90F362TE	CAN	48	5	24	Yes	FLASH	64K	3K	-	8	-	10bit x 16	-	2	-	16bit x 4
MB90360E	MB90F362TES	CAN	48	5	24	-	FLASH	64K	3K	-	8	-	10bit x 16	-	2	-	16bit x 4

Microcontrollers (16-bit Proprietary F²MC-16LX Family)

Timer			Serial		Communication				IE bus [ch.]	LCD controller [seg. x com.]	Inverter	VFD	Functions	Evaluation device	Part number	Series
Input capture [ch.]	PWC timer [ch.]	Up/Down counter [ch.]	[ch.]	I ² C [ch.]	UART/SIO [ch.]	CAN [ch.]	USB-Host [ch.]	USB-Function [ch.]								
16bit x 6	-	-	2	1	2/-	1	-	-	-	-	-	LIN Clock Supervisor	MB90V340A-104	MB90356E	MB90350E	
16bit x 6	-	-	2	1	2/-	1	-	-	-	-	-	LIN Clock Supervisor	MB90V340A-103	MB90356ES	MB90350E	
16bit x 6	-	-	2	1	2/-	1	-	-	-	-	-	LIN Low-voltage detection reset Clock Supervisor	MB90V340A-104	MB90356TE	MB90350E	
16bit x 6	-	-	2	1	2/-	1	-	-	-	-	-	LIN Low-voltage detection reset Clock Supervisor	MB90V340A-103	MB90356TES	MB90350E	
16bit x 6	-	-	2	1	2/-	1	-	-	-	-	-	LIN Clock Supervisor	MB90V340A-104	MB90357E	MB90350E	
16bit x 6	-	-	2	1	2/-	1	-	-	-	-	-	LIN Clock Supervisor	MB90V340A-103	MB90357ES	MB90350E	
16bit x 6	-	-	2	1	2/-	1	-	-	-	-	-	LIN Low-voltage detection reset Clock Supervisor	MB90V340A-104	MB90357TE	MB90350E	
16bit x 6	-	-	2	1	2/-	1	-	-	-	-	-	LIN Low-voltage detection reset Clock Supervisor	MB90V340A-103	MB90357TES	MB90350E	
16bit x 6	-	-	2	1	2/-	1	-	-	-	-	-	LIN	MB90V340E-102	MB90F351E	MB90350E	
16bit x 6	-	-	2	1	2/-	1	-	-	-	-	-	LIN	MB90V340E-101	MB90F351ES	MB90350E	
16bit x 6	-	-	2	1	2/-	1	-	-	-	-	-	LIN Low-voltage detection reset	MB90V340E-102	MB90F351TE	MB90350E	
16bit x 6	-	-	2	1	2/-	1	-	-	-	-	-	LIN Low-voltage detection reset	MB90V340E-101	MB90F351TES	MB90350E	
16bit x 6	-	-	2	1	2/-	1	-	-	-	-	-	LIN	MB90V340E-102	MB90F352E	MB90350E	
16bit x 6	-	-	2	1	2/-	1	-	-	-	-	-	LIN	MB90V340E-101	MB90F352ES	MB90350E	
16bit x 6	-	-	2	1	2/-	1	-	-	-	-	-	LIN Low-voltage detection reset	MB90V340E-102	MB90F352TE	MB90350E	
16bit x 6	-	-	2	1	2/-	1	-	-	-	-	-	LIN Low-voltage detection reset	MB90V340E-101	MB90F352TES	MB90350E	
16bit x 6	-	-	2	1	2/-	1	-	-	-	-	-	LIN Clock Supervisor	MB90V340A-104	MB90F356E	MB90350E	
16bit x 6	-	-	2	1	2/-	1	-	-	-	-	-	LIN Clock Supervisor	MB90V340A-103	MB90F356ES	MB90350E	
16bit x 6	-	-	2	1	2/-	1	-	-	-	-	-	LIN Low-voltage detection reset Clock Supervisor	MB90V340A-104	MB90F356TE	MB90350E	
16bit x 6	-	-	2	1	2/-	1	-	-	-	-	-	LIN Low-voltage detection reset Clock Supervisor	MB90V340A-103	MB90F356TES	MB90350E	
16bit x 6	-	-	2	1	2/-	1	-	-	-	-	-	LIN Clock Supervisor	MB90V340A-104	MB90F357E	MB90350E	
16bit x 6	-	-	2	1	2/-	1	-	-	-	-	-	LIN Clock Supervisor	MB90V340A-103	MB90F357ES	MB90350E	
16bit x 6	-	-	2	1	2/-	1	-	-	-	-	-	LIN Low-voltage detection reset Clock Supervisor	MB90V340A-104	MB90F357TE	MB90350E	
16bit x 6	-	-	2	1	2/-	1	-	-	-	-	-	LIN Low-voltage detection reset Clock Supervisor	MB90V340A-103	MB90F357TES	MB90350E	
16bit x 2	-	-	2	-	2/-	1	-	-	-	-	-	LIN	MB90V340E-102	MB90362E	MB90360E	
16bit x 2	-	-	2	-	2/-	1	-	-	-	-	-	LIN	MB90V340E-101	MB90362ES	MB90360E	
16bit x 2	-	-	2	-	2/-	1	-	-	-	-	-	LIN Low-voltage detection reset	MB90V340E-102	MB90362TE	MB90360E	
16bit x 2	-	-	2	-	2/-	1	-	-	-	-	-	LIN Low-voltage detection reset	MB90V340E-101	MB90362TES	MB90360E	
16bit x 2	-	-	2	-	2/-	1	-	-	-	-	-	LIN Clock Supervisor	MB90V340A-104	MB90367E	MB90360E	
16bit x 2	-	-	2	-	2/-	1	-	-	-	-	-	LIN Clock Supervisor	MB90V340A-103	MB90367ES	MB90360E	
16bit x 2	-	-	2	-	2/-	1	-	-	-	-	-	LIN Low-voltage detection reset Clock Supervisor	MB90V340A-104	MB90367TE	MB90360E	
16bit x 2	-	-	2	-	2/-	1	-	-	-	-	-	LIN Low-voltage detection reset Clock Supervisor	MB90V340A-103	MB90367TES	MB90360E	
16bit x 2	-	-	2	-	2/-	1	-	-	-	-	-	LIN	MB90V340E-102	MB90F362E	MB90360E	
16bit x 2	-	-	2	-	2/-	1	-	-	-	-	-	LIN	MB90V340E-101	MB90F362ES	MB90360E	
16bit x 2	-	-	2	-	2/-	1	-	-	-	-	-	LIN Low-voltage detection reset	MB90V340E-102	MB90F362TE	MB90360E	
16bit x 2	-	-	2	-	2/-	1	-	-	-	-	-	LIN Low-voltage detection reset	MB90V340E-101	MB90F362TES	MB90360E	

(Continued)

Microcontrollers (16-bit Proprietary F²MC-16LX Family)

Series	Part number	Aprication	Package [pin]	Operating voltage : V _{CC} [V]	Internal clock frequency [Max., MHz]	Sub-clock	Memory type	ROM [byte]	RAM [byte]	DMAC [ch.]	External interrupts [ch.]	External bus	A/D converter [bit x ch.]	D/A converter [bit x ch.]	Timer		
															16-bit timer [ch.]	Output compare [ch.]	PPG timer [ch.]
MB90360E	MB90F367E	CAN	48	5	24	Yes	FLASH	64K	3K	-	8	-	10bit x 16	-	2	-	16bit x 4
MB90360E	MB90F367ES	CAN	48	5	24	-	FLASH	64K	3K	-	8	-	10bit x 16	-	2	-	16bit x 4
MB90360E	MB90F367TE	CAN	48	5	24	Yes	FLASH	64K	3K	-	8	-	10bit x 16	-	2	-	16bit x 4
MB90360E	MB90F367TES	CAN	48	5	24	-	FLASH	64K	3K	-	8	-	10bit x 16	-	2	-	16bit x 4
MB90370	MB90372	LCD controller	144	3	16	Yes	MASK	64K	6K	-	6	-	10bit x 12	8bit x 2	4	-	-
MB90370	MB90F372	LCD controller	144	3	16	Yes	FLASH	64K	6K	-	6	-	10bit x 12	8bit x 2	4	-	-
MB90378	MB90F378	LCD controller	144	3	16	Yes	FLASH	128K	6K	-	24	-	10bit x 12	8bit x 2	6	-	-
MB90385	MB90387	CAN	48	5	16	Yes	MASK	64K	2K	-	4	-	10bit x 8	-	2	-	16bit x 4
MB90385	MB90387S	CAN	48	5	16	-	MASK	64K	2K	-	4	-	10bit x 8	-	2	-	16bit x 4
MB90385	MB90F387	CAN	48	5	16	Yes	FLASH	64K	2K	-	4	-	10bit x 8	-	2	-	16bit x 4
MB90385	MB90F387S	CAN	48	5	16	-	FLASH	64K	2K	-	4	-	10bit x 8	-	2	-	16bit x 4
MB90390	MB90394HA	CAN	120	5	24	-	MASK	384K	10K	-	8	-	10bit x 15	-	4	16bit x 8	16bit x 6
MB90390	MB90F394HA	CAN	120	5	24	-	FLASH	384K	10K	-	8	-	10bit x 15	-	4	16bit x 8	16bit x 6
MB90420G	MB90423GA	CAN	100	5	16	-	MASK	128K	6K	-	8	-	10bit x 8	-	2	-	4
MB90420G	MB90423GC	CAN	100	5	16	Yes	MASK	128K	6K	-	8	-	10bit x 8	-	2	-	4
MB90420G	MB90F423GA	CAN	100	5	16	-	FLASH	128K	6K	-	8	-	10bit x 8	-	2	-	4
MB90420G	MB90F423GC	CAN	100	5	16	Yes	FLASH	128K	6K	-	8	-	10bit x 8	-	2	-	4
MB90425G	MB90427GA	CAN	100	5	16	-	MASK	64K	4K	-	8	-	10bit x 8	-	2	-	4
MB90425G	MB90427GC	CAN	100	5	16	Yes	MASK	64K	4K	-	8	-	10bit x 8	-	2	-	4
MB90425G	MB90428GA	CAN	100	5	16	-	MASK	128K	6K	-	8	-	10bit x 8	-	2	-	4
MB90425G	MB90428GC	CAN	100	5	16	Yes	MASK	128K	6K	-	8	-	10bit x 8	-	2	-	4
MB90425G	MB90F428GA	CAN	100	5	16	-	FLASH	128K	6K	-	8	-	10bit x 8	-	2	-	4
MB90425G	MB90F428GC	CAN	100	5	16	Yes	FLASH	128K	6K	-	8	-	10bit x 8	-	2	-	4
MB90435	MB90437L	Standard	100	5	16	Yes	MASK	64K	2K	-	8	Yes	10bit x 8	-	2	4	6
MB90435	MB90437LS	Standard	100	5	16	-	MASK	64K	2K	-	8	Yes	10bit x 8	-	2	4	6
MB90435	MB90438L	Standard	100	5	16	Yes	MASK	128K	4K	-	8	Yes	10bit x 8	-	2	4	6
MB90435	MB90438LS	Standard	100	5	16	-	MASK	128K	4K	-	8	Yes	10bit x 8	-	2	4	6
MB90435	MB90439	Standard	100	5	16	Yes	MASK	256K	6K	-	8	Yes	10bit x 8	-	2	4	6
MB90435	MB90439S	Standard	100	5	16	-	MASK	256K	6K	-	8	Yes	10bit x 8	-	2	4	6
MB90435	MB90F438L	Standard	100	5	16	Yes	FLASH	128K	4K	-	8	Yes	10bit x 8	-	2	4	6
MB90435	MB90F438LS	Standard	100	5	16	-	FLASH	128K	4K	-	8	Yes	10bit x 8	-	2	4	6
MB90435	MB90F439	Standard	100	5	16	Yes	FLASH	256K	6K	-	8	Yes	10bit x 8	-	2	4	6
MB90435	MB90F439S	Standard	100	5	16	-	FLASH	256K	6K	-	8	Yes	10bit x 8	-	2	4	6
MB90440G	MB90443G **	CAN	100	5	16	Yes	MASK	128K	6K	-	8	Yes	10bit x 8	-	16bit x 2	16bit x 4	16bit x 8
MB90440G	MB90F443G	CAN	100	5	16	Yes	FLASH	128K	6K	-	8	Yes	10bit x 8	-	16bit x 2	16bit x 4	16bit x 8
MB90455	MB90455	Standard	48	5	16	Yes	MASK	24K	2K	-	4	-	10bit x 8	-	16bit x 2	-	16bit x 4
MB90455	MB90455S	Standard	48	5	16	-	MASK	24K	2K	-	4	-	10bit x 8	-	16bit x 2	-	16bit x 4
MB90455	MB90456	Standard	48	5	16	Yes	MASK	32K	2K	-	4	-	10bit x 8	-	16bit x 2	-	16bit x 4
MB90455	MB90456S	Standard	48	5	16	-	MASK	32K	2K	-	4	-	10bit x 8	-	16bit x 2	-	16bit x 4
MB90455	MB90457	Standard	48	5	16	Yes	MASK	64K	2K	-	4	-	10bit x 8	-	16bit x 2	-	16bit x 4
MB90455	MB90457S	Standard	48	5	16	-	MASK	64K	2K	-	4	-	10bit x 8	-	16bit x 2	-	16bit x 4
MB90455	MB90F455	Standard	48	5	16	Yes	FLASH	24K	2K	-	4	-	10bit x 8	-	16bit x 2	-	16bit x 4
MB90455	MB90F455S	Standard	48	5	16	-	FLASH	24K	2K	-	4	-	10bit x 8	-	16bit x 2	-	16bit x 4
MB90455	MB90F456	Standard	48	5	16	Yes	FLASH	32K	2K	-	4	-	10bit x 8	-	16bit x 2	-	16bit x 4
MB90455	MB90F456S	Standard	48	5	16	-	FLASH	32K	2K	-	4	-	10bit x 8	-	16bit x 2	-	16bit x 4
MB90455	MB90F457	Standard	48	5	16	Yes	FLASH	64K	2K	-	4	-	10bit x 8	-	16bit x 2	-	16bit x 4
MB90455	MB90F457S	Standard	48	5	16	-	FLASH	64K	2K	-	4	-	10bit x 8	-	16bit x 2	-	16bit x 4
MB90460	MB90462	Inverter control	64	5	16	-	MASK	64K	2K	-	8	-	10bit x 8	-	2	6	4
MB90460	MB90467	Inverter control	64	5	16	-	MASK	64K	2K	-	8	-	10bit x 8	-	2	6	4
MB90460	MB90F462	Inverter control	64	5	16	-	FLASH	64K	2K	-	8	-	10bit x 8	-	2	6	4
MB90480B	MB90F481B	Standard	100	3	25	Yes	FLASH	192K	4K	16	8	Yes	10bit x 8	-	1	6	2
MB90480B	MB90F482B	Standard	100	3	25	Yes	FLASH	256K	6K	16	8	Yes	10bit x 8	-	1	6	2
MB90485B	MB90483C	Standard	100	3	25	Yes	MASK	256K	16K	16	8	Yes	10bit x 8	-	1	6	2
MB90485B	MB90487B	Standard	100	3	25	Yes	MASK	192K	10K	16	8	Yes	10bit x 8	-	1	6	2
MB90485B	MB90488B	Standard	100	3	25	Yes	MASK	256K	10K	16	8	Yes	10bit x 8	-	1	6	2

** : Under planning

Microcontrollers (16-bit Proprietary F²MC-16LX Family)

Timer			Serial		Communication			IE bus [ch.]	LCD controller [seg. x com.]	Inverter	VFD	Functions	Evaluation device	Part number	Series
Input capture [ch.]	PWC timer [ch.]	Up/Down counter [ch.]	[ch.]	I ² C [ch.]	UART/SIO [ch.]	CAN [ch.]	USB-Host [ch.]								
16bit x 2	-	-	2	-	2/-	1	-	-	-	-	-	LIN Clock Supervisor	MB90V340A-104	MB90F367E	MB90360E
16bit x 2	-	-	2	-	2/-	1	-	-	-	-	-	LIN Clock Supervisor	MB90V340A-103	MB90F367ES	MB90360E
16bit x 2	-	-	2	-	2/-	1	-	-	-	-	-	LIN Low-voltage detection reset Clock Supervisor	MB90V340A-104	MB90F367TE	MB90360E
16bit x 2	-	-	2	-	2/-	1	-	-	-	-	-	LIN Low-voltage detection reset Clock Supervisor	MB90V340A-103	MB90F367TES	MB90360E
16bit x 3	-	-	3	2	3/-	-	-	-	-	9 x 4	-	Bit decoder PS/2 interface LPC interface	MB90V370	MB90372	MB90370
16bit x 3	-	-	3	2	3/-	-	-	-	-	9 x 4	-	Bit decoder PS/2 interface LPC interface	MB90V370	MB90F372	MB90370
16bit x 5	-	-	6	2	3/3	-	-	-	-	9 x 4	-	Bit decoder PS/2 interface LPC interface	MB90V378	MB90F378	MB90378
16bit x 2	-	-	1	-	1/-	1	-	-	-	-	-	-	MB90V495G	MB90387	MB90385
16bit x 2	-	-	1	-	1/-	1	-	-	-	-	-	-	MB90V495G	MB90387S	MB90385
16bit x 2	-	-	1	-	1/-	1	-	-	-	-	-	-	MB90V495G	MB90F387	MB90385
16bit x 2	-	-	1	-	1/-	1	-	-	-	-	-	-	MB90V495G	MB90F387S	MB90385
16bit x 6	-	-	4	1	3/1	2	-	-	-	-	-	SMC: 6ch. Sound Generator	MB90V390HB	MB90394HA	MB90390
16bit x 6	-	-	4	-	3/1	2	-	-	-	-	-	SMC: 6ch. Sound Generator	MB90V390HB	MB90F394HA	MB90390
16bit x 3	-	-	2	-	2/-	2	-	-	-	24 x 4	-	Sound Generator	MB90V420G	MB90423GA	MB90420G
16bit x 3	-	-	2	-	2/-	2	-	-	-	24 x 4	-	Sound Generator	MB90V420G	MB90423GC	MB90420G
16bit x 3	-	-	2	-	2/-	2	-	-	-	24 x 4	-	Sound Generator	MB90V420G	MB90F423GA	MB90420G
16bit x 3	-	-	2	-	2/-	2	-	-	-	24 x 4	-	Sound Generator	MB90V420G	MB90F423GC	MB90420G
16bit x 3	-	-	2	-	2/-	1	-	-	-	24 x 4	-	Sound Generator	MB90V420G	MB90427GA	MB90425G
16bit x 3	-	-	2	-	2/-	1	-	-	-	24 x 4	-	Sound Generator	MB90V420G	MB90427GC	MB90425G
16bit x 3	-	-	2	-	2/-	1	-	-	-	24 x 4	-	Sound Generator	MB90V420G	MB90428GA	MB90425G
16bit x 3	-	-	2	-	2/-	1	-	-	-	24 x 4	-	Sound Generator	MB90V420G	MB90428GC	MB90425G
16bit x 3	-	-	2	-	2/-	1	-	-	-	24 x 4	-	Sound Generator	MB90V420G	MB90F428GA	MB90425G
16bit x 3	-	-	2	-	2/-	1	-	-	-	24 x 4	-	Sound Generator	MB90V420G	MB90F428GC	MB90425G
8bit x 2	-	-	3	-	2/1	-	-	-	-	-	-	-	MB90V540G	MB90437L	MB90435
8bit x 2	-	-	3	-	2/1	-	-	-	-	-	-	-	MB90V540G	MB90437LS	MB90435
8bit x 2	-	-	3	-	2/1	-	-	-	-	-	-	-	MB90V540G	MB90438L	MB90435
8bit x 2	-	-	3	-	2/1	-	-	-	-	-	-	-	MB90V540G	MB90438LS	MB90435
8bit x 2	-	-	3	-	2/1	-	-	-	-	-	-	-	MB90V540G	MB90439	MB90435
8bit x 2	-	-	3	-	2/1	-	-	-	-	-	-	-	MB90V540G	MB90439S	MB90435
8bit x 2	-	-	3	-	2/1	-	-	-	-	-	-	-	MB90V540G	MB90F438L	MB90435
8bit x 2	-	-	3	-	2/1	-	-	-	-	-	-	-	MB90V540G	MB90F438LS	MB90435
8bit x 2	-	-	3	-	2/1	-	-	-	-	-	-	-	MB90V540G	MB90F439	MB90435
8bit x 2	-	-	3	-	2/1	-	-	-	-	-	-	-	MB90V540G	MB90F439S	MB90435
16bit x 4	-	-	3	-	2/1	3	-	-	-	-	-	-	MB90V440G	MB90443G **	MB90440G
16bit x 4	-	-	3	-	2/1	3	-	-	-	-	-	-	MB90V440G	MB90F443G	MB90440G
16bit x 2	-	-	1	-	1/-	-	-	-	-	-	-	-	MB90V495G	MB90455	MB90455
16bit x 2	-	-	1	-	1/-	-	-	-	-	-	-	-	MB90V495G	MB90455S	MB90455
16bit x 2	-	-	1	-	1/-	-	-	-	-	-	-	-	MB90V495G	MB90456	MB90455
16bit x 2	-	-	1	-	1/-	-	-	-	-	-	-	-	MB90V495G	MB90456S	MB90455
16bit x 2	-	-	1	-	1/-	-	-	-	-	-	-	-	MB90V495G	MB90457	MB90455
16bit x 2	-	-	1	-	1/-	-	-	-	-	-	-	-	MB90V495G	MB90457S	MB90455
16bit x 2	-	-	1	-	1/-	-	-	-	-	-	-	-	MB90V495G	MB90F455	MB90455
16bit x 2	-	-	1	-	1/-	-	-	-	-	-	-	-	MB90V495G	MB90F455S	MB90455
16bit x 2	-	-	1	-	1/-	-	-	-	-	-	-	-	MB90V495G	MB90F456	MB90455
16bit x 2	-	-	1	-	1/-	-	-	-	-	-	-	-	MB90V495G	MB90F456S	MB90455
16bit x 2	-	-	1	-	1/-	-	-	-	-	-	-	-	MB90V495G	MB90F457	MB90455
16bit x 2	-	-	1	-	1/-	-	-	-	-	-	-	-	MB90V495G	MB90F457S	MB90455
16bit x 3	2	-	2	-	2/-	-	-	-	-	-	Yes	-	MB90V460	MB90462	MB90460
16bit x 3	1	-	2	-	2/-	-	-	-	-	-	Yes	-	MB90V460	MB90467	MB90460
16bit x 3	2	-	2	-	2/-	-	-	-	-	-	Yes	-	MB90V460	MB90F462	MB90460
16bit x 3	-	2	3	-	1/2	-	-	-	-	-	-	-	MB90V480	MB90F481B	MB90480B
16bit x 3	-	2	3	-	1/2	-	-	-	-	-	-	-	MB90V480	MB90F482B	MB90480B
16bit x 3	3	2	3	1	1/2	-	-	-	-	-	-	-	MB90V485B	MB90483C	MB90485B
16bit x 3	3	2	3	1	1/2	-	-	-	-	-	-	-	MB90V485B	MB90487B	MB90485B
16bit x 3	3	2	3	1	1/2	-	-	-	-	-	-	-	MB90V485B	MB90488B	MB90485B

(Continued)

Microcontrollers (16-bit Proprietary F²MC-16LX Family)

Series	Part number	Application	Package [pin]	Operating voltage : V _{CC} [V]	Internal clock frequency [Max., MHz]	Sub-clock	Memory type	ROM [byte]	RAM [byte]	DMAC [ch.]	External interrupts [ch.]	External bus	A/D converter [bit x ch.]	D/A converter [bit x ch.]	Timer		
															16-bit timer [ch.]	Output compare [ch.]	PPG timer [ch.]
MB90485B	MB90F488B	Standard	100	3	25	Yes	FLASH	256K	10K	16	8	Yes	10bit x 8	-	1	6	2
MB90485B	MB90F489B	Standard	100	3	25	Yes	FLASH	384K	24K	16	8	Yes	10bit x 8	-	1	6	2
MB90495G	MB90497G	CAN	64	5	16	Yes	MASK	64K	2K	-	8	Yes	10bit x 8	-	2	-	4
MB90495G	MB90F497G	CAN	64	5	16	Yes	FLASH	64K	2K	-	8	Yes	10bit x 8	-	2	-	4
MB90495G	MB90F498G	CAN	64	5	16	Yes	FLASH	128K	2K	-	8	Yes	10bit x 8	-	2	-	4
MB90520B	MB90522B	LCD controller	128	5	16	Yes	MASK	64K	4K	-	8	-	10bit x 8	8bit x 2	2	8	2
MB90520B	MB90523B	LCD controller	128	5	16	Yes	MASK	64K	4K	-	8	-	10bit x 8	8bit x 2	2	8	2
MB90520B	MB90F523B	LCD controller	128	5	16	Yes	FLASH	128K	4K	-	8	-	10bit x 8	8bit x 2	2	8	2
MB90540G	MB90543G	CAN	100	5	16	Yes	MASK	128K	6K	-	8	Yes	10bit x 8	-	2	4	8
MB90540G	MB90543GS	CAN	100	5	16	-	MASK	128K	6K	-	8	Yes	10bit x 8	-	2	4	8
MB90540G	MB90F543G	CAN	100	5	16	Yes	FLASH	128K	6K	-	8	Yes	10bit x 8	-	2	4	8
MB90540G	MB90F543GS	CAN	100	5	16	-	FLASH	128K	6K	-	8	Yes	10bit x 8	-	2	4	8
MB90545G	MB90547G	CAN	100	5	16	Yes	MASK	64K	2K	-	8	Yes	10bit x 8	-	2	4	8
MB90545G	MB90547GS	CAN	100	5	16	-	MASK	64K	2K	-	8	Yes	10bit x 8	-	2	4	8
MB90545G	MB90548G	CAN	100	5	16	Yes	MASK	128K	4K	-	8	Yes	10bit x 8	-	2	4	8
MB90545G	MB90548GS	CAN	100	5	16	-	MASK	128K	4K	-	8	Yes	10bit x 8	-	2	4	8
MB90545G	MB90549G	CAN	100	5	16	Yes	MASK	256K	6K	-	8	Yes	10bit x 8	-	2	4	8
MB90545G	MB90549GS	CAN	100	5	16	-	MASK	256K	6K	-	8	Yes	10bit x 8	-	2	4	8
MB90545G	MB90F546G	CAN	100	5	16	Yes	FLASH	256K	8K	-	8	Yes	10bit x 8	-	2	4	8
MB90545G	MB90F546GS	CAN	100	5	16	-	FLASH	256K	8K	-	8	Yes	10bit x 8	-	2	4	8
MB90545G	MB90F548G	CAN	100	5	16	Yes	FLASH	128K	4K	-	8	Yes	10bit x 8	-	2	4	8
MB90545G	MB90F548GL	CAN	100	5	16	Yes	FLASH	128K	4K	-	8	Yes	10bit x 8	-	2	4	8
MB90545G	MB90F548GLS	CAN	100	5	16	-	FLASH	128K	4K	-	8	Yes	10bit x 8	-	2	4	8
MB90545G	MB90F548GS	CAN	100	5	16	-	FLASH	128K	4K	-	8	Yes	10bit x 8	-	2	4	8
MB90545G	MB90F549G	CAN	100	5	16	Yes	FLASH	256K	6K	-	8	Yes	10bit x 8	-	2	4	8
MB90545G	MB90F549GS	CAN	100	5	16	-	FLASH	256K	6K	-	8	Yes	10bit x 8	-	2	4	8
MB90550A	MB90552A	Standard	100	5	16	-	MASK	64K	2K	-	8	Yes	10bit x 8	-	2	4	4
MB90550A	MB90553A	Standard	100	5	16	-	MASK	128K	4K	-	8	Yes	10bit x 8	-	2	4	4
MB90550A	MB90F553A	Standard	100	5	16	-	FLASH	128K	4K	-	8	Yes	10bit x 8	-	2	4	4
MB90550A	MB90P553A	Standard	100	5	16	-	OTP	128K	4K	-	8	Yes	10bit x 8	-	2	4	4
MB90550A	MB90T552A	Standard	100	5	16	-	No ROM/ External ROM	-	2K	-	8	Yes	10bit x 8	-	2	4	4
MB90550A	MB90T553A	Standard	100	5	16	-	No ROM/ External ROM	-	4K	-	8	Yes	10bit x 8	-	2	4	4
MB90550B	MB90552B	Standard	100	5	16	-	MASK	64K	2K	-	8	Yes	10bit x 8	-	2	4	4
MB90550B	MB90553B	Standard	100	5	16	-	-	128K	4K	-	8	Yes	10bit x 8	-	2	4	4
MB90560	MB90561A	Inverter control	64	5	16	-	MASK	32K	1K	-	8	-	10bit x 8	-	2	6	4
MB90560	MB90562A	Inverter control	64	5	16	-	MASK	64K	2K	-	8	-	10bit x 8	-	2	6	4
MB90560	MB90F562B	Inverter control	64	5	16	-	FLASH	64K	2K	-	8	-	10bit x 8	-	2	6	4
MB90565	MB90567	Inverter control	64	3.3	16	-	MASK	96K	4K	-	8	-	10bit x 8	-	2	6	4
MB90565	MB90568	Inverter control	64	3.3	16	-	MASK	128K	4K	-	8	-	10bit x 8	-	2	6	4
MB90565	MB90F568	Inverter control	64	3.3	16	-	FLASH	128K	4K	-	8	-	10bit x 8	-	2	6	4
MB90570A	MB90573	Standard	120	5	16	Yes	MASK	128K	6K	-	8	Yes	10bit x 8	8bit x 2	-	4	2
MB90570A	MB90F574A	Standard	120	5	16	Yes	FLASH	256K	10K	-	8	Yes	10bit x 8	8bit x 2	-	4	2
MB90570C	MB90574C	Standard	120	5	16	Yes	MASK	256K	10K	-	8	Yes	10bit x 8	8bit x 2	-	4	2
MB90580	MB90583C	IE bus	100	5	16	Yes	MASK	128K	6K	-	8	Yes	10bit x 8	8bit x 2	3	2	4
MB90580	MB90583CA	IE bus	100	5	16	-	MASK	128K	6K	-	8	Yes	10bit x 8	8bit x 2	3	2	4
MB90580	MB90587C	IE bus	100	5	16	Yes	MASK	64K	4K	-	8	Yes	10bit x 8	8bit x 2	3	2	4
MB90580	MB90587CA	IE bus	100	5	16	-	MASK	64K	4K	-	8	Yes	10bit x 8	8bit x 2	3	2	4
MB90580	MB90F583C	IE bus	100	5	16	Yes	FLASH	128K	6K	-	8	Yes	10bit x 8	8bit x 2	3	2	4
MB90580	MB90F583CA	IE bus	100	5	16	-	FLASH	128K	6K	-	8	Yes	10bit x 8	8bit x 2	3	2	4
MB90580	MB90F584C	IE bus	100	5	16	Yes	FLASH	256K	6K	-	8	Yes	10bit x 8	8bit x 2	3	2	4
MB90580	MB90F584CA	IE bus	100	5	16	-	FLASH	256K	6K	-	8	Yes	10bit x 8	8bit x 2	3	2	4
MB90590G	MB90591G	CAN	100	5	16	-	MASK	384K	8K	-	8	-	10bit x 8	-	2	6	6
MB90590G	MB90594G	CAN	100	5	16	-	MASK	256K	6K	-	8	-	10bit x 8	-	2	6	6

Microcontrollers (16-bit Proprietary F²MC-16LX Family)

Timer			Serial		Communication				IE bus [ch.]	LCD controller [seg. x com.]	Inverter	VFD	Functions	Evaluation device	Part number	Series
Input capture [ch.]	PWC timer [ch.]	Up/Down counter [ch.]	[ch.]	I ² C [ch.]	UART/SIO [ch.]	CAN [ch.]	USB-Host [ch.]	USB-Function [ch.]								
16bit x 3	3	2	3	1	1/2	-	-	-	-	-	-	-	-	MB90V485B	MB90F488B	MB90485B
16bit x 3	3	2	3	1	1/2	-	-	-	-	-	-	-	-	MB90V485B	MB90F489B	MB90485B
16bit x 1	-	-	2	-	2/-	1	-	-	-	-	-	-	-	MB90V495G	MB90497G	MB90495G
16bit x 1	-	-	2	-	2/-	1	-	-	-	-	-	-	-	MB90V495G	MB90F497G	MB90495G
16bit x 1	-	-	2	-	2/-	1	-	-	-	-	-	-	-	MB90V495G	MB90F498G	MB90495G
16bit x 1	-	2	3	-	1/2	-	-	-	-	32 x 4	-	-	-	MB90V520A	MB90522B	MB90520B
16bit x 1	-	2	3	-	1/2	-	-	-	-	32 x 4	-	-	-	MB90V520A	MB90523B	MB90520B
16bit x 1	-	2	3	-	1/2	-	-	-	-	32 x 4	-	-	-	MB90V520A	MB90F523B	MB90520B
16bit x 4	-	-	3	-	2/1	2	-	-	-	-	-	-	-	MB90V540G	MB90543G	MB90540G
16bit x 4	-	-	3	-	2/1	2	-	-	-	-	-	-	-	MB90V540G	MB90543GS	MB90540G
16bit x 4	-	-	3	-	2/1	2	-	-	-	-	-	-	-	MB90V540G	MB90F543G	MB90540G
16bit x 4	-	-	3	-	2/1	2	-	-	-	-	-	-	-	MB90V540G	MB90F543GS	MB90540G
16bit x 4	-	-	3	-	2/1	1	-	-	-	-	-	-	-	MB90V540G	MB90547G	MB90545G
16bit x 4	-	-	3	-	2/1	1	-	-	-	-	-	-	-	MB90V540G	MB90547GS	MB90545G
16bit x 4	-	-	3	-	2/1	1	-	-	-	-	-	-	-	MB90V540G	MB90548G	MB90545G
16bit x 4	-	-	3	-	2/1	1	-	-	-	-	-	-	-	MB90V540G	MB90548GS	MB90545G
16bit x 4	-	-	3	-	2/1	1	-	-	-	-	-	-	-	MB90V540G	MB90549G	MB90545G
16bit x 4	-	-	3	-	2/1	1	-	-	-	-	-	-	-	MB90V540G	MB90549GS	MB90545G
16bit x 4	-	-	3	-	2/1	1	-	-	-	-	-	-	-	MB90V540G	MB90F546G	MB90545G
16bit x 4	-	-	3	-	2/1	1	-	-	-	-	-	-	-	MB90V540G	MB90F546GS	MB90545G
16bit x 4	-	-	3	-	2/1	1	-	-	-	-	-	-	-	MB90V540G	MB90F548G	MB90545G
16bit x 4	-	-	3	-	2/1	1	-	-	-	-	-	-	-	MB90V540G	MB90F548GL	MB90545G
16bit x 4	-	-	3	-	2/1	1	-	-	-	-	-	-	-	MB90V540G	MB90F548GLS	MB90545G
16bit x 4	-	-	3	-	2/1	1	-	-	-	-	-	-	-	MB90V540G	MB90F548GS	MB90545G
16bit x 4	-	-	3	-	2/1	1	-	-	-	-	-	-	-	MB90V540G	MB90F549G	MB90545G
16bit x 4	-	-	3	-	2/1	1	-	-	-	-	-	-	-	MB90V540G	MB90F549GS	MB90545G
8bit x 6	-	-	3	2	1/2	-	-	-	-	-	-	-	-	MB90V550A	MB90552A	MB90550A
8bit x 6	-	-	3	2	1/2	-	-	-	-	-	-	-	-	MB90V550A	MB90553A	MB90550A
8bit x 6	-	-	3	2	1/2	-	-	-	-	-	-	-	-	MB90V550A	MB90F553A	MB90550A
8bit x 6	-	-	3	2	1/2	-	-	-	-	-	-	-	-	MB90V550A	MB90P553A	MB90550A
8bit x 6	-	-	3	2	1/2	-	-	-	-	-	-	-	-	MB90V550A	MB90T552A	MB90550A
8bit x 6	-	-	3	2	1/2	-	-	-	-	-	-	-	-	MB90V550A	MB90T553A	MB90550A
8bit x 6	-	-	3	2	1/2	-	-	-	-	-	-	-	-	MB90V550A	MB90552B	MB90550B
8bit x 6	-	-	3	2	1/2	-	-	-	-	-	-	-	-	MB90V550A	MB90553B	MB90550B
-	-	-	2	-	2/-	-	-	-	-	-	Yes	-	Wave Generator	MB90V560	MB90561A	MB90560
-	-	-	2	-	2/-	-	-	-	-	-	Yes	-	Wave Generator	MB90V560	MB90562A	MB90560
-	-	-	2	-	2/-	-	-	-	-	-	Yes	-	Wave Generator	MB90V560	MB90F562B	MB90560
-	-	-	2	-	2/-	-	-	-	-	-	Yes	-	-	MB90V560	MB90567	MB90565
-	-	-	2	-	2/-	-	-	-	-	-	Yes	-	-	MB90V560	MB90568	MB90565
-	-	-	2	-	2/-	-	-	-	-	-	Yes	-	-	MB90V560	MB90F568	MB90565
8bit x 2	-	8bit x 2	5	1	2/3	-	-	-	-	-	-	-	-	MB90V570A	MB90573	MB90570A
8bit x 2	-	8bit x 2	5	1	2/3	-	-	-	-	-	-	-	-	MB90V570A	MB90F574A	MB90570A
8bit x 2	-	8bit x 2	5	1	2/3	-	-	-	-	-	-	-	-	MB90V570A	MB90574C	MB90570C
8bit x 2	1	-	5	-	5/-	-	-	-	-	1	-	-	-	MB90V580B	MB90583C	MB90580
8bit x 2	1	-	5	-	5/-	-	-	-	-	1	-	-	-	MB90V580B	MB90583CA	MB90580
8bit x 2	1	-	5	-	5/-	-	-	-	-	1	-	-	-	MB90V580B	MB90587C	MB90580
8bit x 2	1	-	5	-	5/-	-	-	-	-	1	-	-	-	MB90V580B	MB90587CA	MB90580
8bit x 2	1	-	5	-	5/-	-	-	-	-	1	-	-	-	MB90V580B	MB90F583C	MB90580
8bit x 2	1	-	5	-	5/-	-	-	-	-	1	-	-	-	MB90V580B	MB90F583CA	MB90580
8bit x 2	1	-	5	-	5/-	-	-	-	-	1	-	-	-	MB90V580B	MB90F584C	MB90580
8bit x 2	1	-	5	-	5/-	-	-	-	-	1	-	-	-	MB90V580B	MB90F584CA	MB90580
8/16bit x 6	-	-	4	-	3/1	2	-	-	-	-	-	-	Stepper Motor Controller: 4ch. Sound generator	MB90V590G	MB90591G	MB90590G
8/16bit x 6	-	-	4	-	3/1	2	-	-	-	-	-	-	Stepper Motor Controller: 4ch. Sound generator	MB90V590G	MB90594G	MB90590G

(Continued)

Microcontrollers (16-bit Proprietary F²MC-16LX Family)

Series	Part number	Application	Package [pin]	Operating voltage : V _{CC} [V]	Internal clock frequency [Max., MHz]	Sub-clock	Memory type	ROM [byte]	RAM [byte]	DMAC [ch.]	External interrupts [ch.]	External bus	A/D converter [bit x ch.]	D/A converter [bit x ch.]	Timer		
															16-bit timer [ch.]	Output compare [ch.]	PPG timer [ch.]
MB90590G	MB90F591G	CAN	100	5	16	-	FLASH	384K	8K	-	8	-	10bit x 8	-	2	6	6
MB90590G	MB90F594G	CAN	100	5	16	-	FLASH	256K	6K	-	8	-	10bit x 8	-	2	6	6
MB90595G	MB90598G	CAN	100	5	16	-	MASK	128K	4K	-	8	-	10bit x 8	-	2	4	4
MB90595G	MB90F598G	CAN	100	5	16	-	FLASH	128K	4K	-	8	-	10bit x 8	-	2	4	4
MB90800	MB90803	LCD controller	100	3	25	Yes	MASK	128K	4K	-	4	-	10bit x 12	-	3	2	2
MB90800	MB90804 **	LCD controller	100	3	25	Yes	MASK	256K	16K	-	4	-	10bit x 12	-	3	2	2
MB90800	MB90F803	LCD controller	100	3	25	Yes	Dual Op. Flash	128K	4K	-	4	-	10bit x 12	-	3	2	2
MB90800	MB90F804	LCD controller	100	3	25	Yes	FLASH	256K	16K	-	4	-	10bit x 12	-	3	2	2
MB90800	MB90F809	LCD controller	100	3	25	Yes	FLASH	192K	10K	-	4	-	10bit x 12	-	3	2	2
MB90820	MB90822	Inverter control	80	5	24	-	MASK	64K	4K	-	8	-	10bit x 16	8bit x 2	2	6	4
MB90820	MB90823	Inverter control	80	5	24	-	MASK	128K	4K	-	8	-	10bit x 16	8bit x 2	2	6	4
MB90820	MB90F822A	Inverter control	80	5	24	-	FLASH	64K	4K	-	8	-	10bit x 16	8bit x 2	2	6	4
MB90820	MB90F823A	Inverter control	80	5	24	-	FLASH	128K	4K	-	8	-	10bit x 16	8bit x 2	2	6	4
MB90860E	MB90867E	Standard	100	5	24	Yes	MASK	128K	6K	16	16	Yes	10bit x 24	-	4	8	8
MB90860E	MB90867ES	Standard	100	5	24	-	MASK	128K	6K	16	16	Yes	10bit x 24	-	4	8	8
MB90860E	MB90F867E	Standard	100	5	24	Yes	FLASH	128K	6K	16	16	Yes	10bit x 24	-	4	8	8
MB90860E	MB90F867ES	Standard	100	5	24	-	FLASH	128K	6K	16	16	Yes	10bit x 24	-	4	8	8
MB90880	MB90882 **	Standard	100	3	33	Yes	MASK	256K	16K	16	24	Yes	10bit x 20	-	4	6	2
MB90880	MB90883 **	Standard	100	3	33	Yes	MASK	384K	24K	16	24	Yes	10bit x 20	-	4	6	2
MB90880	MB90884 **	Standard	100	3	33	Yes	MASK	512K	30K	16	24	Yes	10bit x 20	-	4	6	2
MB90880	MB90F882	Standard	100	3	33	Yes	FLASH	256K	16K	16	24	Yes	10bit x 20	-	4	6	2
MB90880	MB90F882S	Standard	100	3	33	-	FLASH	256K	16K	16	24	Yes	10bit x 20	-	4	6	2
MB90880	MB90F883A	Standard	100	3	25	Yes	FLASH	384K	24K	16	24	Yes	10bit x 20	-	4	6	2
MB90880	MB90F883AS	Standard	100	3	25	-	FLASH	384K	24K	16	24	Yes	10bit x 20	-	4	6	2
MB90880	MB90F884A	Standard	100	3	25	Yes	FLASH	512K	30K	16	24	Yes	10bit x 20	-	4	6	2
MB90880	MB90F884AS	Standard	100	3	25	-	FLASH	512K	30K	16	24	Yes	10bit x 20	-	4	6	2
MB90895	MB90F897	CAN	48	5	16	Yes	Dual Op. Flash	64K	2K	-	4	-	10bit x 8	-	2	-	4
MB90895	MB90F897S	CAN	48	5	16	-	Dual Op. Flash	64K	2K	-	4	-	10bit x 8	-	2	-	4
MB90920	MB90F922NA	CAN	120	5	32	Yes	FLASH	256K	10K	-	8	-	10bit x 8	-	4	-	16bit x 8
MB90920	MB90F922NAS	CAN	120	5	32	-	FLASH	256K	10K	-	8	-	10bit x 8	-	4	-	16bit x 8

** : Under planning

Microcontrollers (16-bit Proprietary F²MC-16LX Family)

Timer			Serial		Communication			IE bus [ch.]	LCD controller [seg. x com.]	Inverter	VFD	Functions	Evaluation device	Part number	Series
Input capture [ch.]	PWC timer [ch.]	Up/Down counter [ch.]	[ch.]	I ² C [ch.]	UART/SIO [ch.]	CAN [ch.]	USB-Host [ch.]								
8/16bit x 6	-	-	4	-	3/1	2	-	-	-	-	-	Stepper Motor Controller: 4ch. Sound generator	MB90V590G	MB90F591G	MB90590G
8/16bit x 6	-	-	4	-	3/1	2	-	-	-	-	-	Stepper Motor Controller: 4ch. Sound generator	MB90V590G	MB90F594G	MB90590G
8/16bit x 6	-	-	3	-	2/1	1	-	-	-	-	-	Stepper Motor Controller: 4ch.	MB90V595G	MB90598G	MB90595G
8/16bit x 6	-	-	3	-	2/1	1	-	-	-	-	-	Stepper Motor Controller: 4ch.	MB90V595G	MB90F598G	MB90595G
16bit x 2	-	-	4	1	2/2	-	-	-	-	48 x 4	-	-	MB90V800	MB90803	MB90800
16bit x 2	-	-	4	1	2/2	-	-	-	-	48 x 4	-	-	MB90V800	MB90804 **	MB90800
16bit x 2	-	-	4	1	2/2	-	-	-	-	48 x 4	-	-	MB90V800	MB90F803	MB90800
16bit x 2	-	-	4	1	2/2	-	-	-	-	48 x 4	-	-	MB90V800	MB90F804	MB90800
16bit x 2	-	-	4	1	2/2	-	-	-	-	48 x 4	-	-	MB90V800	MB90F809	MB90800
16bit x 3	2	-	2	-	2/-	-	-	-	-	-	Yes	-	MB90V820	MB90822	MB90820
16bit x 3	2	-	2	-	2/-	-	-	-	-	-	Yes	-	MB90V820	MB90823	MB90820
16bit x 3	2	-	2	-	2/-	-	-	-	-	-	Yes	-	MB90V820	MB90F822A	MB90820
16bit x 3	2	-	2	-	2/-	-	-	-	-	-	Yes	-	MB90V820	MB90F823A	MB90820
16bit x 8	-	-	4	2	4/-	-	-	-	-	-	-	-	MB90V340E-102	MB90867E	MB90860E
16bit x 8	-	-	4	2	4/-	-	-	-	-	-	-	-	MB90V340E-101	MB90867ES	MB90860E
16bit x 8	-	-	4	2	4/-	-	-	-	-	-	-	-	MB90V340E-102	MB90F867E	MB90860E
16bit x 8	-	-	4	2	4/-	-	-	-	-	-	-	-	MB90V340E-101	MB90F867ES	MB90860E
16bit x 8	-	2	7ch. (Multi Function Serial Interface: UART/SIO/I ² C)			-	-	-	-	-	-	4ch. Base-timer (16bit-reload timer/PWC/PPG/PWM selectable)	MB90V880-102	MB90882 **	MB90880
16bit x 8	-	2	7ch. (Multi Function Serial Interface: UART/SIO/I ² C)			-	-	-	-	-	-	4ch. Base-timer (16bit-reload timer/PWC/PPG/PWM selectable)	MB90V880-102	MB90883 **	MB90880
16bit x 8	-	2	7ch. (Multi Function Serial Interface: UART/SIO/I ² C)			-	-	-	-	-	-	4ch. Base-timer (16bit-reload timer/PWC/PPG/PWM selectable)	MB90V880-102	MB90884 **	MB90880
16bit x 8	-	2	7ch. (Multi Function Serial Interface: UART/SIO/I ² C)			-	-	-	-	-	-	4ch. Base-timer (16bit-reload timer/PWC/PPG/PWM selectable)	MB90V880-102	MB90F882	MB90880
16bit x 8	-	2	7ch. (Multi Function Serial Interface: UART/SIO/I ² C)			-	-	-	-	-	-	4ch. Base-timer (16bit-reload timer/PWC/PPG/PWM selectable)	MB90V880-101	MB90F882S	MB90880
16bit x 8	-	2	7ch. (Multi Function Serial Interface: UART/SIO/I ² C)			-	-	-	-	-	-	4ch. Base-timer (16bit-reload timer/PWC/PPG/PWM selectable)	MB90V880A-102	MB90F883A	MB90880
16bit x 8	-	2	7ch. (Multi Function Serial Interface: UART/SIO/I ² C)			-	-	-	-	-	-	4ch. Base-timer (16bit-reload timer/PWC/PPG/PWM selectable)	MB90V880A-101	MB90F883AS	MB90880
16bit x 8	-	2	7ch. (Multi Function Serial Interface: UART/SIO/I ² C)			-	-	-	-	-	-	4ch. Base-timer (16bit-reload timer/PWC/PPG/PWM selectable)	MB90V880A-102	MB90F884A	MB90880
16bit x 8	-	2	7ch. (Multi Function Serial Interface: UART/SIO/I ² C)			-	-	-	-	-	-	4ch. Base-timer (16bit-reload timer/PWC/PPG/PWM selectable)	MB90V880A-101	MB90F884AS	MB90880
16bit x 2	-	-	2	-	2/-	1	-	-	-	-	-	Dual operation Flash	MB90V495G	MB90F897	MB90895
16bit x 2	-	-	2	-	2/-	1	-	-	-	-	-	Dual operation Flash	MB90V495G	MB90F897S	MB90895
16bit x 6	-	-	4	-	4/-	4	-	-	-	32 x 4	-	Stepper Motor Controller x 4ch., Sound generator x 2ch.	MB90V920-102	MB90F922NA	MB90920
16bit x 6	-	-	4	-	4/-	4	-	-	-	32 x 4	-	Stepper Motor Controller x 4ch., Sound generator x 2ch.	MB90V920-101	MB90F922NAS	MB90920

(Continued)

Microcontrollers (16-bit Proprietary F²MC-16LX Family)

Series	Part number	Aprication	Package [pin]	Operating voltage : V _{CC} [V]	Internal clock frequency [Max., MHz]	Sub-clock	Memory type	ROM [byte]	RAM [byte]	DMAC [ch.]	External interrupts [ch.]	External bus	A/D converter [bit x ch.]	D/A converter [bit x ch.]	Timer		
															16-bit timer [ch.]	Output compare [ch]	PPG timer [ch.]
MB90945	MB90947A	CAN	100	5	24	-	MASK	128K	6K	16	8	-	10bit x 15	-	3	16bit x 4	16bit x 6
MB90945	MB90F946A	CAN	100	5	24	-	FLASH	384K	16K	16	8	-	10bit x 15	-	3	16bit x 4	16bit x 6
MB90945	MB90F947A	CAN	100	5	24	-	FLASH	128K	6K	16	8	-	10bit x 15	-	3	16bit x 4	16bit x 6
MB90945	MB90F949A	CAN	100	5	24	-	FLASH	256K	12K	16	8	-	10bit x 15	-	3	16bit x 4	16bit x 6
MB90960	MB90F962	Standard	48	5	24	Yes	FLASH	64K	3K	-	8	-	10bit x 16	-	2	-	16bit x 4
MB90960	MB90F962S	Standard	48	5	24	-	FLASH	64K	3K	-	8	-	10bit x 16	-	2	-	16bit x 4
MB90980	MB90982	Standard	64	3	25	Yes	MASK	128K	10K	16	8	-	10bit x 8	-	1	4	2
MB90980	MB90F983	Standard	64	3	25	Yes	FLASH	192K	12K	16	8	-	10bit x 8	-	1	4	2
MB90M405	MB90M407	VFD	100	3	16	-	MASK	96K	4K	-	4	-	10bit x 16	-	3	1	2
MB90M405	MB90M408	VFD	100	3	16	-	MASK	128K	4K	-	4	-	10bit x 16	-	3	1	2
MB90M405	MB90MF408	VFD	100	3	16	-	FLASH	128K	4K	-	4	-	10bit x 16	-	3	1	2

Microcontrollers (16-bit Proprietary F²MC-16LX Family)

Timer			Serial			Communication			IE bus [ch.]	LCD controller [seg. x com.]	Inverter	VFD	Functions	Evaluation device	Part number	Series
Input capture [ch.]	PWC timer [ch.]	Up/Down counter [ch.]	[ch.]	I ² C [ch.]	UART/SIO [ch.]	CAN [ch.]	USB-Host [ch.]	USB-Function [ch.]								
16bit x 6	-	-	3	1	2 / 1	1	-	-	-	-	-	LIN	MB90V390HB	MB90947A	MB90945	
16bit x 6	-	-	3	1	3 / 1	1	-	-	-	-	-	LIN	MB90V390HB	MB90F946A	MB90945	
16bit x 6	-	-	3	1	2 / 1	1	-	-	-	-	-	LIN	MB90V390HB	MB90F947A	MB90945	
16bit x 6	-	-	3	1	2 / 1	1	-	-	-	-	-	LIN	MB90V390HB	MB90F949A	MB90945	
16bit x 2	-	-	2	-	2 / -	-	-	-	-	-	-	LIN	MB90V340E-102	MB90F962	MB90960	
16bit x 2	-	-	2	-	2 / -	-	-	-	-	-	-	LIN	MB90V340E-101	MB90F962S	MB90960	
16bit x 2	2	2	3	1	1 / 2	-	-	-	-	-	-	-	MB90V485B	MB90982	MB90980	
16bit x 2	2	2	3	1	1 / 2	-	-	-	-	-	-	-	MB90V485B	MB90F983	MB90980	
-	-	-	4	1	2 / 2	-	-	-	-	-	Yes	VFD	MB90MV405	MB90M407	MB90M405	
-	-	-	4	1	2 / 2	-	-	-	-	-	Yes	VFD	MB90MV405	MB90M408	MB90M405	
-	-	-	4	1	2 / 2	-	-	-	-	-	Yes	VFD	MB90MV405	MB90MF408	MB90M405	

Microcontrollers (16-bit Proprietary F²MC-16FX Family)

Microcontrollers (16-bit Proprietary F²MC-16FX Family)

Series	Part number	Aprication	Package [pin]	Operating voltage : V _{CC} [V]	Internal clock frequency [Max., MHz]	Sub-clock	Memory type	ROM [byte]	RAM [byte]	DMAC [ch.]	External interrupts [ch.]	External bus	A/D converter [bit x ch.]
MB96320	MB96F326RSA	CAN	80	3 or 5	56	-	FLASH	288K	12K	4	15	Yes	10bit x 18
MB96320	MB96F326RWA	CAN	80	3 or 5	56	Yes	FLASH	288K	12K	4	15	Yes	10bit x 18
MB96320	MB96F326YSA	CAN	80	3 or 5	56	-	FLASH	288K	12K	4	15	Yes	10bit x 18
MB96320	MB96F326YWA	CAN	80	3 or 5	56	Yes	FLASH	288K	12K	4	15	Yes	10bit x 18
MB96340	MB96F348HSC	CAN	100	3 or 5	56	-	FLASH	544K	24K	6	16	Yes	10bit x 24
MB96340	MB96F348HWC	CAN	100	3 or 5	56	Yes	FLASH	544K	24K	6	16	Yes	10bit x 24
MB96340	MB96F348RSB	CAN	100	3 or 5	56	-	FLASH	544K	24K	6	16	Yes	10bit x 24
MB96340	MB96F348RWB	CAN	100	3 or 5	56	Yes	FLASH	544K	24K	6	16	Yes	10bit x 24
MB96340	MB96F348TSC	CAN	100	3 or 5	56	-	FLASH	544K	24K	6	16	Yes	10bit x 24
MB96340	MB96F348TWC	CAN	100	3 or 5	56	Yes	FLASH	544K	24K	6	16	Yes	10bit x 24
MB96340	MB96F348YSB	CAN	100	3 or 5	56	-	FLASH	544K	24K	6	16	Yes	10bit x 24
MB96340	MB96F348YWB	CAN	100	3 or 5	56	Yes	FLASH	544K	24K	6	16	Yes	10bit x 24
MB96350	MB96F356RSA	CAN	64	3 or 5	56	-	FLASH	288K	12K	4	13	Yes	10bit x 15
MB96350	MB96F356RWA	CAN	64	3 or 5	56	Yes	FLASH	288K	12K	4	13	Yes	10bit x 15
MB96350	MB96F356YSA	CAN	64	3 or 5	56	-	FLASH	288K	12K	4	13	Yes	10bit x 15
MB96350	MB96F356YWA	CAN	64	3 or 5	56	Yes	FLASH	288K	12K	4	13	Yes	10bit x 15
MB96380	MB96F387RSB	CAN	120	3 or 5	56	-	FLASH	416K	16K	7	8	Yes	10bit x 16
MB96380	MB96F387RWB	CAN	120	3 or 5	56	Yes	FLASH	416K	16K	7	8	Yes	10bit x 16
MB96380	MB96F387YSB	CAN	120	3 or 5	56	-	FLASH	416K	16K	7	8	Yes	10bit x 16
MB96380	MB96F387YWB	CAN	120	3 or 5	56	Yes	FLASH	416K	16K	7	8	Yes	10bit x 16

Microcontrollers (16-bit Proprietary F²MC-16FX Family)

Timer				Serial			Communication	LCD controller [seg. x com.]	Evaluation device	Part number	Series
16-bit timer [ch.]	Output compare [ch]	Input capture [ch.]	PPG timer [ch.]	[ch.]	I ² C [ch.]	UART/ SIO [ch.]	CAN [ch.]				
4	16bit x 6	16bit x 12	16bit x 20	5	1	4 / -	2	-	MB96V300B	MB96F326RSA	MB96320
4	16bit x 6	16bit x 12	16bit x 20	5	1	4 / -	2	-	MB96V300B	MB96F326RWA	MB96320
4	16bit x 6	16bit x 12	16bit x 20	5	1	4 / -	2	-	MB96V300B	MB96F326YSA	MB96320
4	16bit x 6	16bit x 12	16bit x 20	5	1	4 / -	2	-	MB96V300B	MB96F326YWA	MB96320
4	16bit x 8	16bit x 8	16bit x 16	6	2	4 / -	2	-	MB96V300B	MB96F348HSC	MB96340
4	16bit x 8	16bit x 8	16bit x 16	6	2	4 / -	2	-	MB96V300B	MB96F348HWC	MB96340
4	16bit x 8	16bit x 8	16bit x 16	9	2	7 / -	2	-	MB96V300B	MB96F348RSB	MB96340
4	16bit x 8	16bit x 8	16bit x 16	9	2	7 / -	2	-	MB96V300B	MB96F348RWB	MB96340
4	16bit x 8	16bit x 8	16bit x 16	6	2	4 / -	2	-	MB96V300B	MB96F348TSC	MB96340
4	16bit x 8	16bit x 8	16bit x 16	6	2	4 / -	2	-	MB96V300B	MB96F348TWC	MB96340
4	16bit x 8	16bit x 8	16bit x 16	9	2	7 / -	2	-	MB96V300B	MB96F348YSB	MB96340
4	16bit x 8	16bit x 8	16bit x 16	9	2	7 / -	2	-	MB96V300B	MB96F348YWB	MB96340
4	16bit x 4	16bit x 6	16bit x 20	5	1	4 / -	2	-	MB96V300B	MB96F356RSA	MB96350
4	16bit x 4	16bit x 6	16bit x 20	5	1	4 / -	2	-	MB96V300B	MB96F356RWA	MB96350
4	16bit x 4	16bit x 6	16bit x 20	5	1	4 / -	2	-	MB96V300B	MB96F356YSA	MB96350
4	16bit x 4	16bit x 6	16bit x 20	5	1	4 / -	2	-	MB96V300B	MB96F356YWA	MB96350
4	16bit x 4	16bit x 8	16bit x 8	6	1	5 / -	2	65 x 4	MB96V300B	MB96F387RSB	MB96380
4	16bit x 4	16bit x 8	16bit x 8	6	1	5 / -	2	65 x 4	MB96V300B	MB96F387RWB	MB96380
4	16bit x 4	16bit x 8	16bit x 8	6	1	5 / -	2	65 x 4	MB96V300B	MB96F387YSB	MB96380
4	16bit x 4	16bit x 8	16bit x 8	6	1	5 / -	2	65 x 4	MB96V300B	MB96F387YWB	MB96380

Microcontrollers (32-bit Proprietary FR Family)

Microcontrollers (32-bit FR Family)

Series	Part number	Aprication	Package [pin]	Operating voltage : V _{cc} [V]	Internal clock frequency [Max., MHz]	Sub-clock	Memory type	ROM [byte]	RAM [byte]	cache [Kbyte]	DMAC [ch.]	External interrupts [ch.]	External bus	A/D converter [bit x ch.]	D/A converter [bit x ch.]	Timer	
																16-bit timer [ch.]	Output compare [ch.]
MB91101	MB91101A	Standard	100	3 or 5	50	-	No ROM/ External ROM	-	2K	1	8	5	Yes	10bit x 4	-	3	-
MB91107	MB91107A	Standard	120	3	50	-	No ROM/ External ROM	-	128K	1	8	9	Yes	10bit x 4	-	3	-
MB91107	MB91108	Standard	120	3	50	-	No ROM/ External ROM	-	160K	1	8	9	Yes	10bit x 4	-	3	-
MB91121	MB91121	Standard	120	3	50	-	No ROM/ External ROM	-	4K	1	8	8	Yes	10bit x 8	-	3	-
MB91129	MB91F127	Standard	100	3	25	-	FLASH	256K	14K	-	8	6	Yes	10bit x 8	-	3	16bit x 4
MB91129	MB91F128	Standard	100	3	25	-	FLASH	510K	14K	-	8	6	Yes	10bit x 8	-	3	16bit x 4
MB91130	MB91133	Standard	144	3 or 5	33	Yes	MASK	254K	8K	-	8	24	Yes	10bit x 8	8bit x 3	5	16bit x 8
MB91130	MB91F133A	Standard	144	4 or 5	33	Yes	FLASH	254K	8K	-	8	24	Yes	10bit x 8	8bit x 3	5	16bit x 8
MB91150	MB91151A	Standard	144	3	36	-	No ROM/ External ROM	-	34K	1	8	16	Yes	10bit x 8	8bit x 3	4	16bit x 8
MB91150	MB91154	Standard	144	3	33	Yes	MASK	384K	22K	-	8	16	Yes	10bit x 8	8bit x 3	4	16bit x 8
MB91150	MB91155	Standard	144	3	33	Yes	MASK	510K	34K	-	8	16	Yes	10bit x 8	8bit x 3	4	16bit x 8
MB91150	MB91F155A	Standard	144	3	33	Yes	FLASH	510K	34K	-	8	16	Yes	10bit x 8	8bit x 3	4	16bit x 8
MB91150	MB91F158	Standard	120	3	32	-	FLASH	510K	8K	-	-	16	Yes	10bit x 8	8bit x 3	2	16bit x 4
MB91210	MB91213A	CAN	144	5	40	Yes	MASK	544K	24K	-	5	16	-	10bit x 32	-	4	16bit x 8
MB91210	MB91F211B	CAN	100	5	40	Yes	FLASH	288K	16K	-	5	16	-	10bit x 16	-	3	16bit x 8
MB91210	MB91F213A	CAN	144	5	40	Yes	FLASH	544K	24K	-	5	16	-	10bit x 32	-	5	16bit x 8
MB91220	MB91F223	CAN	144	5	32	Yes	FLASH	512K	16K	-	5	8	Yes	10bit x 24	8bit x 2	3	16bit x 2
MB91220	MB91F223S	CAN	144	5	32	-	FLASH	512K	16K	-	5	8	Yes	10bit x 24	8bit x 2	3	16bit x 2
MB91230	MB91233L	LCD controller	120	3	33.6	Yes	MASK	256K	16K	-	-	16	-	10bit x 8	8bit x 2	4	16bit x 4
MB91230	MB91F233	LCD controller	120	3	33.6	Yes	FLASH	256K	16K	-	-	16	-	10bit x 8	8bit x 2	4	16bit x 4
MB91230	MB91F233L	LCD controller	120	3	33.6	Yes	FLASH	256K	16K	-	-	16	-	10bit x 8	8bit x 2	4	16bit x 4
MB91245	MB91248	CAN	144	5	32	Yes	MASK	256K	16K	-	5	8	Yes	10bit x 32	-	3	16bit x 2
MB91245	MB91248S	CAN	144	5	32	-	MASK	256K	16K	-	5	8	Yes	10bit x 32	-	3	16bit x 2
MB91245	MB91F248	CAN	144	5	32	Yes	FLASH	256K	16K	-	5	8	Yes	10bit x 32	-	3	16bit x 2
MB91245	MB91F248S	CAN	144	5	32	-	FLASH	256K	16K	-	5	8	Yes	10bit x 32	-	3	16bit x 2
MB91260B	MB91263B	Inverter control	100	5	33	-	MASK	128K	8K	-	5	10	-	10bit x 12	-	3	16bit x 6
MB91260B	MB91264B	Inverter control	100	5	33	-	MASK	256K	8K	-	5	10	-	10bit x 12	-	3	16bit x 6
MB91260B	MB91F264B	Inverter control	100	5	33	-	FLASH	256K	8K	-	5	10	-	10bit x 12	-	3	16bit x 6
MB91265A	MB91267A	CAN	64	5	33	-	MASK	128K	4K	-	5	8	-	10bit x 11	-	3	16bit x 6
MB91265A	MB91267NA	CAN	64	5	33	-	MASK	128K	4K	-	5	8	-	10bit x 11	-	3	16bit x 6
MB91265A	MB91F267A	CAN	64	5	33	-	Dual Op. Flash	128K	4K	-	5	8	-	10bit x 11	-	3	16bit x 6
MB91265A	MB91F267NA	CAN	64	5	33	-	Dual Op. Flash	128K	4K	-	5	8	-	10bit x 11	-	3	16bit x 6
MB91270	MB91F272 **	CAN	100	5	32	Yes	FLASH	256K	10K	-	5	16	Yes	10bit x 24	-	3	16bit x 8
MB91270	MB91F272S **	CAN	100	5	32	-	FLASH	256K	10K	-	5	16	Yes	10bit x 24	-	3	16bit x 8
MB91270	MB91F273	CAN	100	5	32	Yes	FLASH	512K	24K	-	5	16	Yes	10bit x 24	-	3	16bit x 8
MB91270	MB91F273S	CAN	100	5	32	-	FLASH	512K	24K	-	5	16	Yes	10bit x 24	-	3	16bit x 8

** : Under planning

Microcontrollers (32-bit Proprietary FR Family)

Timer					Serial		Communication			LCD controller [seg. x com.]	Inverter	Functions	Evaluation device	Part number	Series	
Input capture [ch.]	PPG timer [ch.]	PWM timer [ch.]	PWC timer [ch.]	Up/Down counter [ch.]	[ch.]	I ² C [ch.]	UART/SIO [ch.]	CAN [ch.]	USB-Host [ch.]							USB-Function [ch.]
-	-	16bit x 4	-	-	3	-	3/-	-	-	-	-	DRAM I/F	MB91V101A	MB91101A	MB91101	
-	-	16bit x 4	-	-	3	-	3/-	-	-	-	-	DRAM I/F	MB91V108	MB91107A	MB91107	
-	-	16bit x 4	-	-	3	-	3/-	-	-	-	-	DRAM I/F	MB91V108	MB91108	MB91107	
-	-	16bit x 4	-	-	3	-	3/-	-	-	-	-	DRAM I/F DSP	MB91V121	MB91121	MB91121	
16bit x 4	16bit x 4	-	-	-	3	-	3/-	-	-	-	-	-	MB91FV129	MB91F127	MB91129	
16bit x 4	16bit x 4	-	-	-	3	-	3/-	-	-	-	-	-	MB91FV129	MB91F128	MB91129	
16bit x 4	16bit x 6	-	-	8bit x 2	5	-	5/-	-	-	-	-	-	MB91FV130	MB91133	MB91130	
16bit x 4	16bit x 6	-	-	8bit x 2	5	-	5/-	-	-	-	-	-	MB91FV130	MB91F133A	MB91130	
16bit x 4	16bit x 6	-	-	8bit x 2	4	-	4/-	-	-	-	-	-	MB91V151A	MB91151A	MB91150	
16bit x 4	16bit x 6	-	-	8bit x 2	4	1	4/-	-	-	-	-	-	MB91FV150	MB91154	MB91150	
16bit x 4	16bit x 6	-	-	8bit x 2	4	1	4/-	-	-	-	-	-	MB91FV150	MB91155	MB91150	
16bit x 4	16bit x 6	-	-	8bit x 2	4	1	4/-	-	-	-	-	-	MB91FV150	MB91F155A	MB91150	
16bit x 4	16bit x 4	-	-	8bit x 2	2	-	2/-	-	-	-	-	-	MB91FV150	MB91F158	MB91150	
16bit x 4	16bit x 8	-	-	-	7	-	7/-	3	-	-	-	CAN: 32Msg-buffer, LIN	MB91V210	MB91213A	MB91210	
16bit x 4	16bit x 4	-	-	-	5	-	5/-	1	-	-	-	CAN: 32Msg-buffer, LIN	MB91V210	MB91F211B	MB91210	
16bit x 4	16bit x 8	-	-	-	7	-	7/-	3	-	-	-	CAN: 32Msg-buffer, LIN	MB91V210	MB91F213A	MB91210	
16bit x 4	16bit x 16	-	16bit x 1	-	4	-	4/-	2	-	-	32 x 4	CAN: 32Msg-buffer, SMC x 4ch., Sound generator x 3ch., LIN	MB91V220	MB91F223	MB91220	
16bit x 4	16bit x 16	-	16bit x 1	-	4	-	4/-	2	-	-	32 x 4	CAN: 32Msg-buffer, SMC x 4ch., Sound generator x 3ch., LIN	MB91V220	MB91F223S	MB91220	
16bit x 2	16bit x 6	-	8bit x 2	8bit x 2	4	-	4/-	-	-	-	32 x 4	-	MB91V230	MB91233L	MB91230	
16bit x 2	16bit x 6	-	8bit x 2	8bit x 2	4	-	4/-	-	-	-	32 x 6	-	MB91V230	MB91F233	MB91230	
16bit x 2	16bit x 6	-	8bit x 2	8bit x 2	4	-	4/-	-	-	-	32 x 5	-	MB91V230	MB91F233L	MB91230	
16bit x 4	16bit x 4	-	16bit x 1	-	4	-	4/-	2	-	-	32 x 4	CAN: 32Msg-buffer SMC x 6ch. LIN	MB91V245A	MB91248	MB91245	
16bit x 4	16bit x 4	-	16bit x 1	-	4	-	4/-	2	-	-	32 x 4	CAN: 32Msg-buffer SMC x 6ch. LIN	MB91V245A	MB91248S	MB91245	
16bit x 4	16bit x 4	-	16bit x 1	-	4	-	4/-	2	-	-	32 x 4	CAN: 32Msg-buffer SMC x 6ch. LIN	MB91V245A	MB91F248	MB91245	
16bit x 4	16bit x 4	-	16bit x 1	-	4	-	4/-	2	-	-	32 x 4	CAN: 32Msg-buffer SMC x 6ch. LIN	MB91V245A	MB91F248S	MB91245	
16bit x 4	16bit x 8	-	16bit x 2	-	3	-	3/-	-	-	-	-	Yes	MB91V260B	MB91263B	MB91260B	
16bit x 4	16bit x 8	-	16bit x 2	-	3	-	3/-	-	-	-	-	Yes	MB91V260B	MB91264B	MB91260B	
16bit x 4	16bit x 8	-	16bit x 2	-	3	-	3/-	-	-	-	-	Yes	MB91V260B	MB91F264B	MB91260B	
16bit x 4	16bit x 4	-	16bit x 1	-	2	-	2/-	1	-	-	-	Yes	CAN: 32Msg-buffer	MB91V265A	MB91267A	MB91265A
16bit x 4	16bit x 4	-	16bit x 1	-	2	-	2/-	1	-	-	-	Yes	CAN: 32Msg-buffer	MB91V265A	MB91267NA	MB91265A
16bit x 4	16bit x 4	-	16bit x 1	-	2	-	2/-	1	-	-	-	Yes	CAN: 32Msg-buffer	MB91V265A	MB91F267A	MB91265A
16bit x 4	16bit x 4	-	16bit x 1	-	2	-	2/-	1	-	-	-	Yes	CAN: 32Msg-buffer	MB91V265A	MB91F267NA	MB91265A
16bit x 8	16bit x 8	-	-	8bit x 2	7	3	7/-	1	-	-	-	CAN: 32Msg-buffer, LIN	MB91V280	MB91F272 **	MB91270	
16bit x 8	16bit x 8	-	-	8bit x 2	7	3	7/-	1	-	-	-	CAN: 32Msg-buffer, LIN	MB91V280	MB91F272S **	MB91270	
16bit x 8	16bit x 8	-	-	8bit x 2	7	3	7/-	1	-	-	-	CAN: 32Msg-buffer, LIN	MB91V280	MB91F273	MB91270	
16bit x 8	16bit x 8	-	-	8bit x 2	7	3	7/-	1	-	-	-	CAN: 32Msg-buffer, LIN	MB91V280	MB91F273S	MB91270	

(Continued)

Microcontrollers (32-bit Proprietary FR Family)

Series	Part number	Aprication	Package [pin]	Operating voltage : V _{CC} [V]	Internal clock frequency [Max., MHz]	Sub-clock	Memory type	ROM [byte]	RAM [byte]	cache [Kbyte]	DMAC [ch.]	External interrupts [ch.]	External bus	A/D converter [bit x ch.]	D/A converter [bit x ch.]	Timer	
																16-bit timer [ch.]	Output compare [ch.]
MB91270	MB91F277 **	CAN	100	5	32	Yes	FLASH	256K	10K	-	5	16	Yes	10bit x 24	-	3	16bit x 8
MB91270	MB91F277S **	CAN	100	5	32	-	FLASH	256K	10K	-	5	16	Yes	10bit x 24	-	3	16bit x 8
MB91270	MB91F278 **	CAN	100	5	32	Yes	FLASH	512K	24K	-	5	16	Yes	10bit x 24	-	3	16bit x 8
MB91270	MB91F278S **	CAN	100	5	32	-	FLASH	512K	24K	-	5	16	Yes	10bit x 24	-	3	16bit x 8
MB91301	MB91302A	Standard	144	3	68	-	MASK	Yes	4K	4	5	9	Yes	10bit x 4	-	3	-
MB91301	MB91302A-010	Standard	144	3	68	-	No ROM/ External ROM	-	4K	4	5	9	Yes	10bit x 4	-	3	-
MB91301	MB91302A-020	Standard	144	3	68	-	No ROM/ External ROM	-	4K	4	5	9	Yes	10bit x 4	-	3	-
MB91305	MB91305	USB 内蔵	176	3	64	-	No ROM/ External ROM	-	64K	4	5	16	Yes	10bit x 10	-	3	-
MB91307	MB91306R	Standard	120	3	66	-	No ROM/ External ROM	-	64K	1	5	9	Yes	10bit x 4	-	3	-
MB91307	MB91307B	Standard	120	3	66	-	No ROM/ External ROM	-	128K	1	5	9	Yes	10bit x 4	-	3	-
MB91307	MB91307R	Standard	120	3	66	-	No ROM/ External ROM	-	128K	1	5	9	Yes	10bit x 4	-	3	-
MB91310	MB91F312A	USB	144	3	40	Yes	FLASH	512K	16K	-	5	5	-	10bit x 10	-	3	16bit x 4
MB91313	MB91F313	Standard	120	3	33	Yes	FLASH	544K	32K	-	5	24	Yes	10bit x 10	-	6	-
MB91314A	MB91314A	Standard	120	3	33	Yes	MASK	256K	32K	-	5	24	Yes	10bit x 10	-	6	-
MB91314A	MB91F314A	Standard	120	3	33	Yes	FLASH	512K	32K	-	5	24	Yes	10bit x 10	-	6	-
MB91319	MB91316A	USB	176	3	40	Yes	MASK	512K	32K	-	5	5	-	10bit x 10	-	3	16bit x 4
MB91319	MB91F318R	USB	176	3	40	Yes	FLASH	1024K	48K	-	5	5	-	10bit x 10	-	4	16bit x 4
MB91345	MB91F345B	Standard	100	3	50	-	FLASH	512K	32K	-	5	24	Yes	10bit x 16	-	3	16bit x 4
MB91345	MB91F346B *	Standard	100	3	50	-	FLASH	1024K	32K	-	5	24	Yes	10bit x 16	-	3	16bit x 4
MB91350A	MB91351A *	Standard	120	3	50	Yes	MASK	384K	24K	-	5	9	Yes	10bit x 8	8bit x 2	4	16bit x 2
MB91350A	MB91352A	Standard	120	3	50	Yes	MASK	384K	16K	-	5	9	Yes	10bit x 8	8bit x 2	4	16bit x 2
MB91350A	MB91353A	Standard	120	3	50	Yes	MASK	512K	24K	-	5	9	Yes	10bit x 8	8bit x 2	4	16bit x 2
MB91350A	MB91354A	Standard	176	3	50	Yes	MASK	384K	16K	-	5	17	Yes	10bit x 12	8bit x 3	4	16bit x 8
MB91350A	MB91355A	Standard	176	3	50	Yes	MASK	512K	24K	-	5	17	Yes	10bit x 12	8bit x 3	4	16bit x 8
MB91350A	MB91F353A	Standard	120	3	50	Yes	FLASH	512K	24K	-	5	9	Yes	10bit x 8	8bit x 2	4	16bit x 2
MB91350A	MB91F355A	Standard	176	3	50	Yes	FLASH	512K	24K	-	5	17	Yes	10bit x 12	8bit x 3	4	16bit x 8
MB91350A	MB91F356B	Standard	176	3	50	Yes	FLASH	256K	24K	-	5	17	Yes	10bit x 12	8bit x 3	4	16bit x 8
MB91360	MB91366GA	CAN	120	5	64	Yes	MASK	513K	36K	-	5	8	-	10bit x 8	-	6	16bit x 2
MB91360	MB91F362GB	CAN	208	5	64	-	FLASH	512K	20K	-	5	8	Yes	10bit x 16	10bit x 2	6	16bit x 4
MB91360	MB91F364G	CAN	120	5	64	-	FLASH	256K	16K	-	5	8	-	10bit x 12	10bit x 2	3	16bit x 2
MB91360	MB91F365GB	CAN	120	5	64	-	FLASH	512K	36K	-	5	8	-	10bit x 8	10bit x 2	6	16bit x 2
MB91360	MB91F366GB	CAN	120	5	64	Yes	FLASH	514K	36K	-	5	8	-	10bit x 8	-	6	16bit x 2
MB91360	MB91F367GB	CAN	120	5	64	-	FLASH	515K	36K	-	5	8	-	10bit x 8	-	3	16bit x 2
MB91360	MB91F368GB	CAN	120	5	64	Yes	FLASH	516K	36K	-	5	8	-	10bit x 8	-	3	16bit x 2
MB91360	MB91F369GA	CAN	160	5	64	-	FLASH	517K	36K	-	5	8	Yes	10bit x 10	-	6	-
MB91360	MB91F376G	CAN	120	5	64	Yes	FLASH	768K	36K	-	5	8	-	10bit x 8	-	6	16bit x 2
MB91460	MB91461	CAN	176	3	80	-	No ROM/ External ROM	-	64K	4	5	16	Yes	10bit x 13	-	4	16bit x 4
MB91460	MB91F464AB	CAN	100	5	80	Yes	FLASH	416K	16K	-	5	10	-	10bit x 21	-	8	16bit x 6

*: Under development, **: Under planning

Microcontrollers (32-bit Proprietary FR Family)

Timer					Serial		Communication			LCD controller [seg. x com.]	Inverter	Functions	Evaluation device	Part number	Series	
Input capture [ch.]	PPG timer [ch.]	PWM timer [ch.]	PWC timer [ch.]	Up/Down counter [ch.]	I ² C [ch.]	UART/SIO [ch.]	CAN [ch.]	USB-Host [ch.]	USB-Function [ch.]							
16bit x 8	16bit x 8	-	-	8bit x 2	7	3	7/-	1	-	-	-	-	CAN:32Msg-buffer, LIN, Clock supervisor	MB91V280	MB91F277 **	MB91270
16bit x 8	16bit x 8	-	-	8bit x 2	7	3	7/-	1	-	-	-	-	CAN:32Msg-buffer, LIN, Clock supervisor	MB91V280	MB91F277S **	MB91270
16bit x 8	16bit x 8	-	-	8bit x 2	7	3	7/-	1	-	-	-	-	CAN:32Msg-buffer, LIN, Clock supervisor	MB91V280	MB91F278 **	MB91270
16bit x 8	16bit x 8	-	-	8bit x 2	7	3	7/-	1	-	-	-	-	CAN:32Msg-buffer, LIN, Clock supervisor	MB91V280	MB91F278S **	MB91270
16bit x 4	16bit x 4	-	-	-	3	2	3/-	-	-	-	-	-	SDRAM I/F†	MB91V301A	MB91302A	MB91301
16bit x 4	16bit x 4	-	-	-	3	2	3/-	-	-	-	-	-	RTOS	MB91V301A	MB91302A-010	MB91301
16bit x 4	16bit x 4	-	-	-	3	2	3/-	-	-	-	-	-	Program Loader	MB91V301A	MB91302A-020	MB91301
16bit x 4	16bit x 4	-	16bit x 1	-	5	4	5/-	-	-	1	-	-	SDRAM I/F	MB91305	MB91305	MB91305
-	-	-	-	-	3	1	3/-	-	-	-	-	-	-	MB91V307R	MB91306R	MB91307
-	-	-	-	-	3	1	3/-	-	-	-	-	-	-	MB91V307R	MB91307B	MB91307
-	-	-	-	-	3	1	3/-	-	-	-	-	-	-	MB91V307R	MB91307R	MB91307
16bit x 4	16bit x 4	-	16bit x 1	-	5	4	5/-	-	1	1	-	-	OSDC	MB91FV310A	MB91F312A	MB91310
-	16bit x 4	-	16bit x 1	-	11ch. (Multi Function Serial Interface: UART/SIO/I ² C)		-	-	-	-	-	-	HDMI-CEC/ Remote control receiver 2 ch., Multifunction timer x 4 ch.	-	MB91F313	MB91313
-	16bit x 4	-	16bit x 1	-	11ch. (Multi Function Serial Interface: UART/SIO/I ² C)		-	-	-	-	-	-	CCD x 1 ch., Multifunction timer x 4 ch.	-	MB91314A	MB91314A
-	16bit x 4	-	16bit x 1	-	11ch. (Multi Function Serial Interface: UART/SIO/I ² C)		-	-	-	-	-	-	CCD x 1 ch., Multifunction timer x 4 ch.	-	MB91F314A	MB91314A
16bit x 4	16bit x 4	-	16bit x 1	-	5	4	5/-	-	-	1	-	-	OSDC, CCD	MB91FV319R	MB91316A	MB91319
16bit x 4	16bit x 4	-	16bit x 1	-	5	4	5/-	-	-	1	-	-	OSDC, CCD	MB91FV319R	MB91F318R	MB91319
16bit x 4	16bit x 8	-	16bit x 1	16bit x 2	11ch. (Multi Function Serial Interface: UART/SIO/I ² C)		-	-	-	-	-	-	-	MB91F345	MB91F345B	MB91345
16bit x 4	16bit x 8	-	16bit x 1	16bit x 2	11ch. (Multi Function Serial Interface: UART/SIO/I ² C)		-	-	-	-	-	-	-	MB91F346	MB91F346B *	MB91345
16bit x 4	16bit x 3	-	-	8bit x 1	6	1	4/2	-	-	-	-	-	-	MB91V350A	MB91351A *	MB91350A
16bit x 4	16bit x 3	-	-	8bit x 1	6	1	4/2	-	-	-	-	-	-	MB91V350A	MB91352A	MB91350A
16bit x 4	16bit x 3	-	-	8bit x 1	6	1	4/2	-	-	-	-	-	-	MB91V350A	MB91353A	MB91350A
16bit x 4	16bit x 6	-	-	8bit x 2	8	1	5/3	-	-	-	-	-	-	MB91V350A	MB91354A	MB91350A
16bit x 4	16bit x 6	-	-	8bit x 2	8	1	5/3	-	-	-	-	-	-	MB91V350A	MB91355A	MB91350A
16bit x 4	16bit x 3	-	-	8bit x 1	6	1	4/2	-	-	-	-	-	-	MB91V350A	MB91F353A	MB91350A
16bit x 4	16bit x 6	-	-	8bit x 2	8	1	5/3	-	-	-	-	-	-	MB91V350A	MB91F355A	MB91350A
16bit x 4	16bit x 6	-	-	8bit x 2	8	1	5/3	-	-	-	-	-	-	MB91V350A	MB91F356B	MB91350A
16bit x 4	16bit x 8	-	-	-	4	1	2/2	2	-	-	-	-	Sound generator	MB91FV360GA	MB91366GA	MB91360
16bit x 4	16bit x 8	16bit x 8	-	-	5	1	3/2	3	-	-	-	-	SMC Sound generator	MB91FV360GA	MB91F362GB	MB91360
16bit x 4	16bit x 4	-	-	-	4	1	2/2	1	-	-	-	-	-	MB91FV360GA	MB91F364G	MB91360
16bit x 4	16bit x 8	-	-	-	4	1	2/2	2	-	-	-	-	Sound generator	MB91FV360GA	MB91F365GB	MB91360
16bit x 4	16bit x 8	-	-	-	4	1	2/2	2	-	-	-	-	Sound generator	MB91FV360GA	MB91F366GB	MB91360
16bit x 4	16bit x 4	-	-	-	3	1	1/2	2	-	-	-	-	-	MB91FV360GA	MB91F367GB	MB91360
16bit x 4	16bit x 4	-	-	-	3	1	1/2	2	-	-	-	-	-	MB91FV360GA	MB91F368GB	MB91360
-	16bit x 4	-	-	-	3	1	1/2	2	-	-	-	-	Sound generator	MB91FV360GA	MB91F369GA	MB91360
16bit x 4	16bit x 8	-	-	-	4	1	2/2	2	-	-	-	-	Sound generator	MB91FV360GA	MB91F376G	MB91360
16bit x 4	16bit x 8	-	-	-	7	3	7/-	2	-	-	-	-	CAN: 32Msg-buffer, LIN	MB91V460	MB91461	MB91460
16bit x 8	16bit x 10	-	-	-	5	1	5/-	1	-	-	-	-	CAN: 32Msg-buffer, LIN	MB91V460	MB91F464AB	MB91460

(Continued)

FR Family product list

Microcontrollers (32-bit Proprietary FR Family)

Series	Part number	Aprication	Package [pin]	Operating voltage : V _{CC} [V]	Internal clock frequency [Max., MHz]	Sub-clock	Memory type	ROM [byte]	RAM [byte]	cache [Kbyte]	DMAC [ch.]	External interrupts [ch.]	External bus	A/D converter [bit x ch.]	D/A converter [bit x ch.]	Timer	
																16-bit timer [ch.]	Output compare [ch]
MB91460	MB91F465BA	CAN	144	5	80	Yes	FLASH	544K	40K	8	5	16	Yes	10bit x 16	-	8	16bit x 8
MB91460	MB91F465KB	CAN	120	5	80	Yes	FLASH	544K	16K	4	5	10	-	10bit x 26	-	8	16bit x 8
MB91460	MB91F465XA	CAN	100	5	100	Yes	FLASH	544K	32K	-	5	11	-	10bit x 17	-	8	16bit x 6
MB91460	MB91F467BA	CAN	144	5	80	Yes	FLASH	1088K	40K	8	5	16	Yes	10bit x 16	-	8	16bit x 8
MB91460	MB91F467DB	CAN	208	5	96	Yes	FLASH	1088K	64K	8	5	14	Yes	10bit x 24	-	8	16bit x 4
MB91460	MB91F467R	CAN	176	3	80	Yes	FLASH	1088K	64K	8	5	16	Yes	10bit x 16	-	5	16bit x 4
MB91470	MB91F475	Inverter control	144	5	80	-	FLASH	256K	16K	-	5	10	Yes	10bit x 12	-	2	16bit x 6
MB91470	MB91F478	Inverter control	144	5	80	-	FLASH	384K	24K	-	5	10	Yes	12bit x 4 x 2	-	2	16bit x 6
MB91470	MB91F479	Inverter control	144	5	80	-	FLASH	512K	32K	-	5	10	Yes	12bit x 4 x 2	-	2	16bit x 6
MB91480	MB91482 *	Inverter control	100	5	80	-	MASK	256K	16K	-	5	10	-	10bit x 18	-	2	16bit x 12
MB91480	MB91F482	Inverter control	100	5	80	-	FLASH	256K	16K	-	5	10	-	10bit x 18	-	2	16bit x 12
MB91480	MB91F487	Inverter control	100	5	80	-	FLASH	512K	32K	-	5	10	-	10bit x 18	-	2	16bit x 12
MB91605	MB91605	Standard	176	3	80	-	No ROM/ External ROM	-	128K	Introdu ction : 8 Data : 8	4	24	Yes	10bit x 12	-	Yes	-
MB91635	MB91F637	Standard	144	3	60	Yes	FLASH	512K	48K	-	8	32	Yes	10bit x 31	8bit x 3	Yes	16bit x 8
MB91635	MB91F639	Standard	144	3	60	Yes	FLASH	1M	64K	-	8	32	Yes	10bit x 31	8bit x 3	Yes	16bit x 8
MB91645	MB91F647	Standard	176	3	60	Yes	FLASH	512K	48K	-	8	32	Yes	10bit x 32	8bit x 3	Yes	16bit x 8
MB91660	MB91661*	Standard	120	3	33	Yes	MASK	384K	32K	-	8	32	Yes	10bit x 24 x 2Unit	8bit x 3	Yes	32bit x 8
MB91660	MB91F662	Standard	120	3	33	Yes	FLASH	512K	48K	-	8	32	Yes	10bit x 24 x 2Unit	8bit x 3	Yes	32bit x 8

*: Under development

Microcontrollers (32-bit Proprietary FR Family)

Timer					Serial		Communication			LCD controller [seg. x com.]	Inverter	Functions	Evaluation device	Part number	Series	
Input capture [ch.]	PPG timer [ch.]	PWM timer [ch.]	PWC timer [ch.]	Up/Down counter [ch.]	I ² C [ch.]	UART/SIO [ch.]	CAN [ch.]	USB-Host [ch.]	USB-Function [ch.]							
16bit x 8	16bit x 16	-	-	16bit x 2	7	2	7/-	3	-	-	-	-	CAN: 32Msg-buffer, LIN Sound Gnerator	MB91V460	MB91F465BA	MB91460
16bit x 8	16bit x 12	-	-	-	5	1	5/-	1	-	-	-	-	CAN: 32Msg-buffer LIN	MB91V460	MB91F465KB	MB91460
16bit x 8	16bit x 12	-	-	-	3	1	3/-	2	-	-	-	-	CAN: 32Msg-buffer LIN FlexRay	MB91V460	MB91F465XA	MB91460
16bit x 8	16bit x 16	-	-	16bit x 2	7	2	7/-	6	-	-	-	-	CAN: 32Msg-buffer, LIN, Sound Gnerator	MB91V460	MB91F467BA	MB91460
16bit x 8	16bit x 12	-	-	16bit x 2	5	3	5/-	3	-	-	-	-	CAN: 32Msg-buffer, LIN, Sound Gnerator	MB91V460	MB91F467DB	MB91460
16bit x 4	16bit x 8	-	-	-	7	3	7/-	2	-	-	-	-	CAN: 32, 64Msg-buffer LIN	MB91V460	MB91F467R	MB91460
16bit x 4	16bit x 4	-	-	16bit x 1	6ch. (Multi Function Serial Interface: UART/SIO/I ² C)		-	-	-	-	-	Yes	BaseTimer x 4ch.	MB91V470	MB91F475	MB91470
16bit x 4	16bit x 4	-	-	16bit x 1	6ch. (Multi Function Serial Interface: UART/SIO/I ² C)		-	-	-	-	-	Yes	BaseTimer x 4ch.	MB91V470	MB91F478	MB91470
16bit x 4	16bit x 4	-	-	16bit x 1	6ch. (Multi Function Serial Interface: UART/SIO/I ² C)		-	-	-	-	-	Yes	BaseTimer x 4ch.	MB91V470	MB91F479	MB91470
16bit x 8	16bit x 8	-	-	-	3ch. (Multi Function Serial Interface: UART/SIO/I ² C)		-	-	-	-	-	Yes	BaseTimer x 4ch.	MB91V470	MB91482 *	MB91480
16bit x 8	16bit x 8	-	-	-	3ch. (Multi Function Serial Interface: UART/SIO/I ² C)		-	-	-	-	-	Yes	BaseTimer x 4ch.	MB91V470	MB91F482	MB91480
16bit x 8	16bit x 8	-	-	-	3ch. (Multi Function Serial Interface: UART/SIO/I ² C)		-	-	-	-	-	Yes	BaseTimer x 4ch.	MB91V470	MB91F487	MB91480
-	Yes	Yes	Yes	-	12ch. (Multi Function Serial Interface: UART/SIO/I ² C)		-	-	-	-	-	-	SDRAM I/F, Base Timer: Reload Timer/PPG/PWM/PWC mode selectable, HDMI-CEC x 1ch.	-	MB91605	MB91605
16bit x 8	Yes	Yes	Yes	4bit x 4	12ch. (Multi Function Serial Interface: UART/SIO/I ² C)		-	-	-	-	-	-	Reload Timer/PPG/PWM/PWC mode selectable, 32 bit mode can be used	MB91V650	MB91F637	MB91635
16bit x 8	Yes	Yes	Yes	4bit x 4	12ch. (Multi Function Serial Interface: UART/SIO/I ² C)		-	-	-	-	-	-	Reload Timer/PPG/PWM/PWC mode selectable, 32 bit mode can be used	MB91V650	MB91F639	MB91635
16bit x 8	Yes	Yes	Yes	4bit x 4	12ch. (Multi Function Serial Interface: UART/SIO/I ² C)		-	-	-	-	-	-	Reload Timer/PPG/PWM/PWC mode selectable, 32 bit mode can be used	MB91V650	MB91F647	MB91645
32bit x 8	Yes	Yes	Yes	-	12ch. (Multi Function Serial Interface: UART/SIO/I ² C)		-	1	1	-	-	-	Base Timer: Reload Timer/PPG/PWM/PWC mode selectable, USB2.0, Slave I/F	-	MB91661*	MB91660
32bit x 8	Yes	Yes	Yes	-	12ch. (Multi Function Serial Interface: UART/SIO/I ² C)		-	1	1	-	-	-	Base Timer: Reload Timer/PPG/PWM/PWC mode selectable, USB2.0, Slave I/F	-	MB91F662	MB91660

FR Family product list

Support Hardware for F²MC-8L Family

Support Hardware for F²MC-8L Family

Development Tools				
Target Microcontroller			Fujitsu Microelectronics ICE	
Series name	Product name	Package (Lead pitch, body size)	Probe	Equipment common to series
MB89051	MB89051 MB89F051	LQFP-64P (0.65 mm, 12 × 12 mm) FPT-64P-M09	Cable : MB2144-220 + Header : MB2144-227-01 **	<ul style="list-style-type: none"> • Main unit : MB2141B • Pod : MB2144-508 • Emulator debugger software : SOFTUNE • RS-232C cable or LAN cable
MB89120	MB89121	QFP-48P (0.8 mm, 10 × 10 mm) FPT-48P-M13	MB2144-203	
MB89120A	MB89123A	QFP-48P (0.8 mm, 10 × 10 mm) FPT-48P-M13	MB2144-203	
	MB89125A	QFP-48P (0.8 mm, 10 × 10 mm) FPT-48P-M13		
MB89130	MB89131 MB89P131	QFP-48P (0.8 mm, 10 × 10 mm) FPT-48P-M13	MB2144-203	
MB89130A	MB89133A MB89P133A	QFP-48P (0.8 mm, 10 × 10 mm) FPT-48P-M13 SDIP-48P DIP-48P-M01	MB2144-203	
	MB89135A MB89P135A	QFP-48P (0.8 mm, 10 × 10 mm) FPT-48P-M13		
MB89140/A	MB89143A MB89144A MB89145 MB89146 MB89P147	SH-DIP-64P DIP-64P-M01	MB2144-201	
		QFP-64P (1.0 mm, 14 × 20 mm) FPT-64P-M06	MB2144-202	
	MB89W147	SH-DIP-64C DIP-64C-A06	MB2144-201	
MB89150	MB89151 MB89152 MB89153 MB89154 MB89155 MB89P155 -101 to 105	LQFP-80P (0.5 mm, 12 × 12 mm) FPT-80P-M05 LQFP-80P (0.65 mm, 14 × 14 mm) FPT-80P-M11 QFP-80P (0.8 mm, 14 × 20 mm) FPT-80P-M06	MB2144-202	
MB89150A	MB89151A MB89152A MB89153A MB89154A MB89155A MB89P155 -201 to 205	LQFP-80P (0.5 mm, 12 × 12 mm) FPT-80P-M05 LQFP-80P (0.65 mm, 14 × 14 mm) FPT-80P-M11 QFP-80P (0.8 mm, 14 × 20 mm) FPT-80P-M06	MB2144-202	
MB89160	MB89161 MB89163 MB89165 MB89P165 -101 to 105	LQFP-80P (0.5 mm, 12 × 12 mm) FPT-80P-M05 LQFP-80P (0.65 mm, 14 × 14 mm) FPT-80P-M11 QFP-80P (0.8 mm, 14 × 20 mm) FPT-80P-M06	MB2144-202	
	MB89W165	QFP-80C (0.8 mm, 14 × 20 mm) FPT-80C-A02		
MB89160L	MB89163L MB89165L	LQFP-80P (0.5 mm, 12 × 12 mm) FPT-80P-M05 LQFP-80P (0.65 mm, 14 × 14 mm) FPT-80P-M11 QFP-80P (0.8 mm, 14 × 20 mm) FPT-80P-M06	MB2144-202	
MB89160A	MB89161A MB89163A MB89165A MB89P165 -201 to 203	LQFP-80P (0.5 mm, 12 × 12 mm) FPT-80P-M05 LQFP-80P (0.65 mm, 14 × 14 mm) FPT-80P-M11 QFP-80P (0.8 mm, 14 × 20 mm) FPT-80P-M06	MB2144-202	

Support Hardware for F²MC-8L Family

Development Tools		Equipment for Program to OTP/EPROM			Target Microcontroller
Evaluation Device (Lead pitch, body size)	IC Package Conversion Adapter *3 (Converting foot patterns of evaluation device)	Microcontroller Subject to Program	EPROM Programmer	IC Package Conversion Adapter *3 (for Program to OTP/ EPROM)	Product name
		Product name			
MB89F051 LQFP-64P (mounted on probe header)	Unnecessary	MB89F051 FPT-64P-M09	Recommended EPROM Programmer *9	FLASH-64QF2-32DP-8LF3	MB89051 MB89F051
			Yokogawa Digital Computer *3 Serial programmer		
MB89PV130A MQP-48C-P01 (0.8 mm, 15 × 15 mm) *5	Unnecessary	MB89P131 FPT-48P-M13	General-purpose EPROM Programmer *6 (capable of programming to MBM27C256A)	ROM-48QF2-28DP-8L	MB89121
	Unnecessary	MB89P133A FPT-48P-M13		ROM-48QF2-28DP-8L	MB89123A
	Unnecessary	MB89P135A FPT-48P-M13		ROM-48QF2-28DP-8L	MB89125A
	Unnecessary	MB89P131 FPT-48P-M13		ROM-48QF2-28DP-8L	MB89131 MB89P131
	Unnecessary	MB89P133A FPT-48P-M13		ROM-48QF2-28DP-8L	MB89133A MB89P133A
	48QF-48SD-8L	MB89P133A DIP-48P-M01		ROM-48SD-28DP-8L2	
	Unnecessary	MB89P135A FPT-48P-M13		ROM-48QF2-28DP-8L	MB89135A MB89P135A
MB89PV140 MDP-64C-P02	Unnecessary	MB89P147 DIP-64P-M01		ROM-64SD-28DP-8L4	MB89143A MB89144A
MB89PV140 MQP-64C-P01 (1.0 mm, 16 × 22 mm) *5	Unnecessary	MB89P147 FPT-64P-M06		ROM-64QF-28DP-8L4	MB89145 MB89146 MB89P147
MB89PV140 MDP-64C-P02	Unnecessary	MB89W147 DIP-64C-A06		ROM-64SD-28DP-8L4	MB89W147
MB89PV150-101 to 105 MQP-80C-P01 (0.8 mm, 16 × 22 mm) *5	80QF-80QF2-8L-UP 80QF-80SQF-8L-DWN	MB89P155-101 to 105 FPT-80P-M05	General-purpose EPROM Programmer *6 (capable of programming to MBM27C256A)	ROM-80SQF-28DP-8L	MB89151 MB89152
	80QF-80QF2-8L-UP 80QF-80QF2-8L-DWN	MB89P155-101 to 105 FPT-80P-M11		ROM-80QF2-28DP-8L2	MB89153 MB89154 MB89155
	Unnecessary	MB89P155-101 to 105 FPT-80P-M06		ROM-80QF-28DP-8L3	MB89P155 -101 to 105
MB89PV150-101 to 105 MQP-80C-P01 (0.8 mm, 16 × 22 mm) *5	80QF-80QF2-8L-UP 80QF-80SQF-8L-DWN	MB89P155 -201 to 205 FPT-80P-M05		ROM-80SQF-28DP-8L	MB89151A MB89152A MB89153A
	80QF-80QF2-8L-UP 80QF-80QF2-8L-DWN	MB89P155-201 to 205 FPT-80P-M11		ROM-80QF2-28DP-8L2	MB89154A MB89155A
	Unnecessary	MB89P155-201 to 205 FPT-80P-M06		ROM-80QF-28DP-8L3	MB89P155 -201 to 205
MB89PV160-101 to 105 MQP-80C-P01 (0.8 mm, 16 × 22 mm) *5	80QF-80QF2-8L-UP 80QF-80SQF-8L-DWN	MB89P165-101 to 105 FPT-80P-M05		ROM-80SQF-28DP-8L	MB89161 MB89163
	80QF-80QF2-8L-UP 80QF-80QF2-8L-DWN	MB89P165-101 to 105 FPT-80P-M11		ROM-80QF2-28DP-8L2	MB89165 MB89P165
	Unnecessary	MB89P165-101 to 105 FPT-80P-M06		ROM-80QF-28DP-8L3	-101 to 105
	Unnecessary	MB89W165 FPT-80C-A02		ROM-80QF-28DP-8L3	MB89W165
MB89PV160-101 to 105 MQP-80C-P01 (0.8 mm, 16 × 22 mm) *5	80QF-80QF2-8L-UP 80QF-80SQF-8L-DWN	MB89P165-101 to 105 FPT-80P-M05	ROM-80SQF-28DP-8L	MB89163L MB89165L	
	80QF-80QF2-8L-UP 80QF-80QF2-8L-DWN	MB89P165-101 to 105 FPT-80P-M11	ROM-80QF2-28DP-8L2		
	Unnecessary	MB89P165-101 to 105 FPT-80P-M06	ROM-80QF-28DP-8L3		
MB89PV160-101 to 105 MQP-80C-P01 (0.8 mm, 16 × 22 mm) *5	80QF-80QF2-8L-UP 80QF-80SQF-8L-DWN	MB89P165-201 to 203 FPT-80P-M05	ROM-80SQF-28DP-8L	MB89161A MB89163A MB89165A MB89P165 -201 to 203	
	80QF-80QF2-8L-UP 80QF-80QF2-8L-DWN	MB89P165-201 to 203 FPT-80P-M11	ROM-80QF2-28DP-8L2		
	Unnecessary	MB89P165-201 to 203 FPT-80P-M06	ROM-80QF-28DP-8L3		

Support Hardware for F²MC-8L Family

Development Tools				
Target Microcontroller			Fujitsu Microelectronics ICE	
Series name	Product name	Package (Lead pitch, body size)	Probe	Equipment common to series
MB89180	MB89181	LQFP-64P (0.65 mm, 12 × 12 mm)	MB2144-202	
	MB89182	FPT-64P-M09		
	MB89183	QFP-64P (1.0 mm, 14 × 20 mm)		
	MB89185	FPT-64P-M06		
-101 to 108	MB89P185	SQFP-64P (0.5 mm, 10 × 10 mm)		
		FPT-64P-M03		
MB89190	MB89191	SOP-28P (1.27 mm, 17.75 × 8.6 mm)	MB2144-203	
	MB89193	FPT-28P-M17		
	MB89195	SH-DIP-28P		
	MB89P195 -101	DIP-28P-M03		
		DIP-28P		
	DIP-28P-M05			
MB89190A	MB89191A	SOP-28P (1.27 mm, 17.75 × 8.6 mm)	MB2144-203	
	MB89191H	FPT-28P-M17		
	MB89193A	SH-DIP-28P		
	MB89193H	DIP-28P-M03		
	MB89195A	DIP-28P		
MB89P195A -201	DIP-28P-M05			
MB89202/R	MB89202	SH-DIP-32P (1.78 mm, 28 × 8.89 mm)	MB2144-201	
	MB89F202	DIP-32P-M06		
	MB89F202R			
	MB89202Y	SSOP-34P (0.65 mm, 11 × 6.1 mm)		
MB89F202Y	MB89F202Y	FPT-34P-M03		
	MB89F202RY			
MB89F202RY	MB89F202RY	QFP-32P (0.8 mm, 7 × 7 mm)		
MB89480	MB89485	LQFP-64P (0.65 mm, 12 × 12 mm)	MB2144-201	
	MB89485L	FPT-64P-M09		
	MB89P485	SH-DIP-64P		
	MB89P485L	DIP-64P-M01		
MB89490	MB89497	QFP-100P (0.65 mm, 14 × 20 mm)	MB2144-202	
	MB89498	FPT-100P-M06		
	MB89F499	LQFP-100P (0.5 mm, 14 × 14 mm)		
		FPT-100P-M05		

Support Hardware for F²MC-8L Family

Development Tools		Equipment for Program to OTP/EPROM			Target Microcontroller
Evaluation Device (Lead pitch, body size)	IC Package Conversion Adapter *3 (Converting foot patterns of evaluation device)	Microcontroller Subject to Program	EPROM Programmer	IC Package Conversion Adapter *3 (for Program to OTP/ EPROM)	Product name
		Product name			
MB89PV180-101 to 107 MQP-64C-P01 (1.0 mm, 16 × 22 mm) *5	Not supported	MB89P185-101 to 107 FPT-64P-M09	General-purpose EPROM Programmer *6 (capable of programming to MBM27C256A)	ROM-64QF2-28DP-8L2	MB89181 MB89182
	Unnecessary	MB89P185-101 to 107 FPT-64P-M06		ROM-64QF-28DP-8L3	MB89183 MB89185
	Not supported	Not OTP ROM type		Not OTP ROM type	MB89P185 -101 to 108
MB89PV190 MQP-48C-P01 (0.8 mm, 15 × 15 mm) *5	48QF-28SOP-8L	MB89P195-101 FPT-28P-M17	General-purpose EPROM Programmer *7	ROM-28SOP-28DP-8L	MB89191
	48QF-28SD-8L	Not OTP ROM type		Not OTP ROM type	MB89193 MB89195
	48QF-28DP-8L	MB89P195-101 DIP-28P-M05		ROM-28DP-28DP-8L	MB89P195-101
MB89PV190A MQP-48C-P01 (0.8 mm, 15 × 15 mm) *5	48QF-28SOP-8L	MB89P195A-201 FPT-28P-M17	General-purpose EPROM Programmer *7	ROM-28SOP-28DP-8L	MB89191A/H
	48QF-28SD-8L	Not OTP ROM type		Not OTP ROM type	MB89193A/H MB89195A
	48QF-28DP-8L	MB89P195A-201 DIP-28P-M05		ROM-28DP-28DP-8L	MB89P195A-201
MB2144-230	Unnecessary	MB89F202 MB89F202R	Flash Support Group Parallel Programmer	TEF110-89F202-PSH	MB89202 MB89F202 MB89F202R
	Tokyo Eletech FEA-20P2	MB89F202Y MB89F202RY		TEF110-89F202-PFV	MB89202Y MB89F202Y MB89F202RY
	Not supported	MB89F202RY		Not supported	MB89F202RY
MB89PV480 MDP-64C-P02	64SD-64QF2-8L	MB89P485 MB89P485L FPT-64P-M09	Recommended EPROM Programmer *9	ROM2-64QF2-32DP-8LA3	MB89485 MB89P485
	Unnecessary	MB89P485 MB89P485L DIP-64P-M01		ROM2-64SD-32DP-8LA3	MB89485L MB89P485L
MB89PV490 MQP-100C-P01 (0.65 mm, 16 × 22 mm)	Unnecessary	MB89F499 FPT-100P-M06	Recommended EPROM Programmer *9 Yokogawa Digital Computer *3 Serial programmer	FLASH-100QF-32DP-8LF2	MB89497 MB89498
	100QF-100SQF-8L			FLASH-100SQF-32DP-8LF	MB89F499

Support Hardware for F²MC-8L Family

Development Tools				
Target Microcontroller			Fujitsu Microelectronics ICE	
Series name	Product name	Package (Lead pitch, body size)	Probe	Equipment common to series
MB89530A	MB89535A MB89537A MB89537AC MB89538A MB89538AC MB89P538 MB89F538	SH-DIP-64P DIP-64P-M01	MB2144-201	
		LQFP-64P (0.5 mm, 10 × 10 mm) FPT-64P-M03		
		LQFP-64P (0.65 mm, 12 × 12 mm) FPT-64P-M09	MB2144-202	
		QFP-64P (1.0 mm, 14 × 20 mm) FPT-64P-M06		<ul style="list-style-type: none"> • Main unit : MB2141B • Pod : MB2144-508
MB89550A	MB89557A MB89558A MB89P558A -201 to 203	TQFP-100P (0.4 mm, 12 × 12 mm) FPT-100P-M18	MB2144-203	<ul style="list-style-type: none"> • Emulator debugger software : SOFTUNE • RS-232C cable or LAN cable
		LQFP-100P (0.5 mm, 14 × 14 mm) FPT-100P-M05		
MB89560	MB89567A MB89567AC MB89P568	LQFP-80P (0.5 mm, 12 × 12 mm) FPT-80P-M05	MB2144-202	
		LQFP-80P (0.65 mm, 14 × 14 mm) FPT-80P-M11		
		QFP-80P (0.8 mm, 14 × 20 mm) FPT-80P-M06		
MB89580B	MB89583B MB89585B MB89P585B	LQFP-64P (0.5 mm, 10 × 10 mm) FPT-64P-M03	Cable : MB2144-220 + Header : MB2144-217-01 *4	
	MB89589B MB89P589B	LQFP-64P (0.65 mm, 12 × 12 mm) FPT-64P-M09	Cable : MB2144-220 + Header : MB2144-224-01 *4	
MB89580BW	MB89583BW MB89585BW MB89P585BW	LQFP-64P (0.5 mm, 10 × 10 mm) FPT-64P-M03	Cable : MB2144-220 + Header : MB2144-225-01 *10	

Support Hardware for F²MC-8L Family

Development Tools		Equipment for Program to OTP/EPROM			Target Microcontroller
Evaluation Device (Lead pitch, body size)	IC Package Conversion Adapter *3 (Converting foot patterns of evaluation device)	Microcontroller Subject to Program	EPROM Programmer	IC Package Conversion Adapter *3 (for Program to OTP/ EPROM)	Product name
		Product name			
MB89PV530 MDIP-64C-P02	Unnecessary	MB89P538 DIP-64P-M01	General-purpose EPROM Programmer (capable of programming to MBM27C1001) *6	ROM-64SD-32DP-8LA2	
		MB89F538 DIP-64P-M01	Recommended EPROM Programmer *9 TSUZUKI DENSAN TF-WRITER	FLASH-64SD-32DP-8LF	
	64SD-64SQF-8L	Not OTP and ROM type	—	Not OTP and ROM type	
	64SD-64QF2-8L	MB89P538 FPT-64P-M09	General-purpose EPROM Programmer (capable of programming to MBM27C1001) *6	ROM-64QF2-32DP-8LA	
MB89F538 FPT-64P-M09		Recommended EPROM Programmer *9 TSUZUKI DENSAN TF-WRITER	FLASH-64QF2-32DP-8LF2		
MB89PV530 MQP-64C-P01 (1.0 mm, 16 × 22 mm) *5	Unnecessary	MB89P538 FPT-64P-M06	General-purpose EPROM Programmer (capable of programming to MBM27C1001) *6	ROM-64QF-32DP-8LA2	
		MB89F538 FPT-64P-M06	Recommended EPROM Programmer *9 TSUZUKI DENSAN TF-WRITER	FLASH-64QF-32DP-8LF	
			Yokogawa Digital Computer *3 Serial programmer		
MB89PV550A MQP-100C-P02 (0.5 mm, 15 × 15 mm) *5	100SQF-100TQF-8L	MB89P558A FPT-100P-M18	General-purpose EPROM Programmer *6 (capable of programming to MBM27C1001)	ROM-100TQF-32DP-8LA	MB89557A MB89558A MB89P558A
			Yokogawa Digital Computer *3 Serial programmer		
	Unnecessary	MB89P558A FPT-100P-M05	General-purpose EPROM Programmer *6 (capable of programming to MBM27C1001)	ROM-100SQF-32DP-8LA2	
			Yokogawa Digital Computer *3 Serial programmer		
MB89PV560 MQP-80C-P01 (0.8 mm, 16 × 22 mm) *5	80QF-80QF2-8L-UP	MB89P568 FPT-80P-M05	General-purpose EPROM Programmer *6 (capable of programming to MBM27C1001)	ROM-80SQF-32DP-8LA	MB89567A MB89567AC MB89P568
	80QF-80QF2-8L-UP	MB89P568 FPT-80P-M11		ROM-80QF2-32DP-8LA2	
	80QF-80QF2-8L-DWN	MB89P568 FPT-80P-M06		ROM-80QF-32DP-8LA2	
MB89P585B LQFP64 (mounted to Probe Header)	Unnecessary	MB89P585B FPT-64P-M03	Recommended EPROM Programmer *8	ROM2-64LQF-32DP-8LA	MB89583B MB89P585B MB89585B
			Yokogawa Digital Computer *3 Serial programmer		
MB89P589B LQFP64 (mounted to Probe Header)		MB89P589B FPT-64P-M09	Recommended EPROM Programmer *8	ROM2-64QF2-32DP-8LA2	MB89589B MB89P589B
MB89P585BW LQFP64 (mounted to Probe Header)	Unnecessary	MB89P585BW FPT-64P-M03	Recommended EPROM Programmer *8	ROM2-64LQF-32DP-8LA	MB89583BW MB89585BW MB89P585BW
			Yokogawa Digital Computer *3 Serial programmer		

Support Hardware for F²MC-8L Family

Development Tools					
Target Microcontroller			Fujitsu Microelectronics ICE		
Series name	Product name	Package (Lead pitch, body size)	Probe	Equipment common to series	
MB89630R	MB89635R MB89T635R MB89636R MB89637R MB89T637R	SH-DIP-64P DIP-64P-M01	MB2144-201		
		LQFP-64P (0.65 mm, 12 × 12 mm) FPT-64P-M09			
		QFP-64P (1.0 mm, 14 × 20 mm) FPT-64P-M06	MB2144-202		
	MB89W637	SH-DIP-64C DIP-64C-A06	MB2144-201		
MB89650AR	MB89653AR MB89655AR MB89656AR MB89657AR MB89P657A	QFP-100P (0.65 mm, 14 × 20 mm) FPT-100P-M06	MB2144-203		
		LQFP-100P (0.5 mm, 14 × 14 mm) FPT-100P-M05			
MB89660R	MB89663R MB89665R MB89P665	SH-DIP-64P DIP-64P-M01	Cable : MB2144-220 + Header : MB2144-216-01		
		QFP-64P (1.0 mm, 14 × 20 mm) FPT-64P-M06	Cable : MB2144-220 + Header : MB2144-215-01 for QFP-64 *4		
MB89670AR	MB89673AR MB89675AR MB89677AR MB89P677A	QFP-80P (0.8 mm, 14 × 20 mm) FPT-80P-M06	MB2144-202		
		LQFP-80P (0.65mm, 14 × 14 mm) FPT-80P-M11			
MB89680	MB89689 MB89P689	QFP-100P (0.65 mm, 14 × 20 mm) FPT-100P-M06	MB2144-202		<ul style="list-style-type: none"> • Main unit : MB2141B • Pod : MB2144-508 • Emulator debugger software : SOFTUNE • RS-232C cable or LAN cable
	MB89W689	QFP-100C (0.65 mm, 14 × 20 mm) FPT-100C-A02			
MB89800	MB89803 MB89805 MB89P808	QFP-100P (0.65 mm, 14 × 20 mm) FPT-100P-M06	MB2144-202		
		LQFP-100P (0.5 mm, 14 × 14 mm) FPT-100P-M05			
MB89810A	MB89816A MB89P817A	QFP-64P (1.0 mm, 14 × 20 mm) FPT-64P-M06	Cable : MB2144-220 + Header : MB2144-214-01A		
MB89820	MB89821 MB89823R MB89825 MB89P825	LQFP-80P (0.65 mm, 14 × 14 mm) FPT-80P-M11	MB2144-202		
		MB89850R	MB89855R MB89P857	QFP-64P (1.0 mm, 14 × 20 mm) FPT-64P-M06	
MB89W857	QFP-64C FPT-64C-A02				
MB89855R MB89P857	SH-DIP-64P DIP-64P-M01				
MB89W857	SH-DIP-64C DIP-64C-A06				
MB89863	MB89863	QFP-48P (0.8 mm, 10 × 10 mm) FPT-48P-M04	Cable : MB2144-220 + Header : MB2144-212-01A		
MB89860	MB89865 MB89867 MB89P867	QFP-80P (0.8 mm, 14 × 20 mm) FPT-80P-M06	Cable : MB2144-220 + Header : MB2144-211-01A fir QFP-80 *4		
	MB89W867	QFP-80C (0.8 mm, 14 × 20 mm) FPT-80C-A02			
MB89890	MB89898 MB89899 MB89P899	QFP-100P (0.65 mm, 14 × 20 mm) FPT-100P-M06	MB2144-202		
MB89920	MB89923 MB89925 MB89P928	QFP-80P (0.8 mm, 14 × 20 mm) FPT-80P-M06	MB2144-202		

Support Hardware for F²MC-8L Family

Development Tools		Equipment for Program to OTP/EPROM			Target Microcontroller	
Evaluation Device (Lead pitch, body size)	IC Package Conversion Adapter *3 (Converting foot patterns of evaluation device)	Microcontroller Subject to Program	EPROM Programmer	IC Package Conversion Adapter *3 (for Program to OTP/ EPROM)	Product name	
		Product name				
MB89PV630 MDP-64C-P02	Unnecessary	MB89W637 DIP-64P-M01	General-purpose EPROM Programmer *6 (capable of programming to MBM27C256A)	ROM-64SD-28DP-8L	MB89635R MB89T635R MB89636R MB89637R MB89T637R	
	64SD-64QF2-8L	MB89W637 FPT-64P-M09		ROM-64QF2-28DP-8L		
MB89PV630 MQP-64C-P01 (1.0 mm, 16 × 22 mm) *5	Unnecessary	—		—		
MB89PV630 MDP-64C-P02	Unnecessary	MB89W637 DIP-64C-A06		ROM-64SD-28DP-8L		MB89W637
MB89PV650A MQP-100C-P02 (0.5 mm, 15 × 15 mm) *5	100SQF-100QF-8L	MB89P657A FPT-100P-M06		ROM-100QF-28DP-8L2		MB89653AR MB89655AR MB89656AR MB89657AR MB89P657A
	Unnecessary	MB89P657A FPT-100P-M05	ROM-100SQF-28DP-8L			
MB89P665 SH-DIP-64P (mounted to Probe Header)	Unnecessary	MB89P665 DIP-64P-M01	General-purpose EPROM Programmer (capable of programming to MBM27C256A)	ROM-64SD-28DP-8L	MB89663R MB89665R MB89P665	
MB89P665 QFP-64P (mounted to Probe Header)		MB89P665 FPT-64P-M06		ROM-64QF-28DP-8L		
MB89PV670A MQP-80C-P01 (0.8 mm, 16 × 22 mm) *5	Unnecessary	MB89P677A FPT-80P-M06		ROM-80QF-28DP-8L2		MB89673AR MB89675AR MB89677AR MB89P677A
	80QF-80QF2-8L-UP 80QF-80QF2-8L-DWN	MB89P677A FPT-80P-M11		ROM-80QF2-28DP-8L		
MB89PV680 MQP-100C-P01 (0.65 mm, 16 × 22 mm) *5	Unnecessary	MB89P689 MB89W689 FPT-100P-M06		General-purpose EPROM Programmer *6 (capable of programming to MBM27C1001)	ROM-100QF-32DP-8LA	MB89689 MB89P689
		MB89P689 MB89W689 FPT-100C-A02	ROM-100QF-32DP-8LA			
MB89PV800 MQP-100C-P01 (0.65 mm, 16 × 22 mm)	Unnecessary	MB89P808 FPT-100P-M06	General-purpose EPROM Programmer (capable of programming to MBM27C1001)	ROM-100QF-32DP-8LA2	MB89803 MB89805 MB89P808	
	Not supported	MB89P808 FPT-100P-M05		ROM-100SQF-32DP-8LA3		
MB89P817 QFP-64P (1.00mm, 14 × 20mm) (mounted to Probe Header)	Unnecessary	MB89P817A FPT-64P-M06	General-purpose EPROM Programmer (capable of programming to MBM27C256A)	ROM-64QF-28DP-8L	MB89816A MB89P817A	
MB89PV820 MQP-80C-P01 (0.8 mm, 16 × 22 mm) *5	80QF-80QF2-8L-UP 80QF-80QF2-8L-DWN	MB89P825 FPT-80P-M11		ROM-80QF2-28DP-8L3	MB89821 MB89823R MB89825 MB89P825	
				ROM-64QF-28DP-8L	MB89855R MB89P857	
MB89P857 SH-DIP-64P (mounted to Probe Header)	64SD-64QF-8L	MB89P857 FPT-64P-M06 MB89W857 FPT-64C-A02		ROM-64QF-28DP-8L5	MB89W857	
	Unnecessary	MB89P857 DIP-64P-M01 MB89W857 FPT-64C-A06		ROM-64SD-28DP-8L	MB89855R MB89P857 MB89W857	
MB89P857 SH-DIP-64P (mounted to Probe Header)	64SD-48QF-8L	MB89P857Av MB89W857 DIP-64P-M01	ROM-64SD-28DP-8L	MB89863		
MB89P867 QFP-80P (14 × 20 mm) (mounted to Probe Header)	Unnecessary	MB89P867 FPT-80P-M06	General-purpose EPROM Programmer (capable of programming to MBM27C256A)	ROM-80QF-28DP-8L2	MB89865 MB89867 MB89P867 MB89W867	
		MB89W867 FPT-80C-A02				
MB89PV890 MQP-100C-P01 (0.65 mm, 16 × 22 mm) *5	Unnecessary	MB89P899 FPT-100P-M06	General-purpose EPROM Programmer (capable of programming to MBM27C1001)	ROM-100QF-32DP-8LA	MB89898 MB89899 MB89P899	
MB89PV920 MQP-80C-P01 (0.8 mm, 16 × 22 mm) *5	Unnecessary	MB89P928 FPT-80P-M06		ROM-80QF-32DP-8LA	MB89923 MB89925 MB89P928	

Support Hardware for F²MC-8L Family

Development Tools				
Target Microcontroller			Fujitsu Microelectronics ICE	
Series name	Product name	Package (Lead pitch, body size)	Probe	Equipment common to series
MB89930A MB89930B	MB89935B MB89P935B	SSOP-30P (0.65 mm, 5.6 × 9.7 mm) FPT-30P-M02	MB2144-203	<ul style="list-style-type: none"> • Main unit : MB2141B • Pod : MB2144-508
MB89940	MB89943 MB89945 MB89P945	QFP-48P (0.8mm, 12 × 12mm) FPT-48P-M16	MB2144-203	
MB89980	MB89983 MB89P985	LQFP-64P (0.65mm, 12 × 12mm) FPT-64P-M09	MB2144-202	<ul style="list-style-type: none"> • RS-232C cable or LAN cable
		LQFP-64P (0.5mm, 10 × 10mm) FPT-64P-M03		

*1 : Under development

*2 : The IC package conversion adapter is provided by Sunhayato Corp. Contact details

Sales Info: Advanced Interconnectics: URL: <http://advintcorp.com>

*3 : Contact details: Yokogawa Digital Computer Corporation TEL(81-42)333-6222 FAX(81-42)352-6107

*4 : For QFP-48 : TQ-PACK048SA and TQ-SOCKET048SAG (each provided)

For QFP-64 : TQ-PACK060RZ and TQ-SOCKET064RZG (each provided)

For LQFP-64 : TQ-PACK064SD and TQ-SOCKET064SD (each provided)

For QFP-80 : TQ-PACK080SA and TQ-SOCKET080RAZ (each provided)

It should be noted that there is a slight difference in footprint size between the Q pack and other mass-produced packages. therefore, caution is required in designing the footprint of the print board.

Sales Info:

• USA:OESS Co. San Jose Office TEL(408)437-1582

• Europe Germany: OESS GmbH TEL(06106)2857890

Tokyo Eletech Co, Ltd. TEL(81)3-3820-7141

Support Hardware for F²MC-8L Family

Development Tools		Equipment for Program to OTP/EPROM			Target Microcontroller
Evaluation Device (Lead pitch, body size)	IC Package Conversion Adapter *3 (Converting foot patterns of evaluation device)	Microcontroller Subject to Program	EPROM Programmer	IC Package Conversion Adapter *3 (for Program to OTP/ EPROM)	Product name
		Product name			
MB89PV930A MQP-48C-P01 (0.8 mm, 15 × 15 mm) *5	48QF-30SOP-8L	MB89P935B FPT-30P-M02	Yokogawa Digital Computer *3 Serial programmer	ROM3-FPT30M02-8L	MB89935B MB89P935B
MB89PV940 MQP-48C-P01 (0.8mm, 15 × 15mm) *5	Unnecessary	MB89P945 FPT-48P-M16	General-purpose EPROM Programmer *6 (capable of programming to MBM27C256A)	ROM-48QF-28DP-8L3	MB89943 MB89945 MB89P945
MB89PV980 MQP-64C-P01 (1.0mm, 16 × 22mm)	Not supported	MB89P985 FPT-64P-M09	General-purpose EPROM Programmer *6 (capable of programming to MBM27C256A)	ROM-64QF2-28DP-8L4	MB89983 MB89P985
	Not supported	MB89P985 FPT-64P-M03		ROM-64SQF-28DP-8L3	

*5 : It should be noted that there is a slight difference in footprint size of mass-produced packages. therefore, caution is required in designing the footprint of the print board.

*6 : Recommended EPROM programmer for OTP/EPROM microcontroller

- Contact details: Data I/O TEL(81-3)3779-2151
- Contact details: Minato Electronics Inc. TEL(81)45-591-5611
- Contact details: Advantest URL: <http://www.advantest.co.jp/index-e.html>

*7 : Recommended EPROM programmer for MB89P195/P195A

- MODEL 1890A(Ver. 2.1 or higher) + OU910(Ver. 4.07 or higher); Contact details: Minato Electronics Inc. TEL(81)45-591-5611
- AF9708, AF9709, AF9723; Contact details: Flash Support Group, Inc. TEL(81)53-428-8383

*8 : Recommended EPROM programmer

- MODEL 1890A(Ver. 2.8 or higher)+OU-910(Ver. 4.32t1 or higher) is required 3 V board (ML 01-781) ;Contact details: Minato Electronics Inc. TEL(81)45-591-5611
- AF9708, AF9709, AF9723; Contact details: Flash Support Group, Inc. TEL(81)53-428-8383

*9 : Recommended EPROM programmer

- MODEL 1890A+OU-910(Ver. 4.32t1 or higher); Contact details: Minato Electronics Inc. TEL(81)45-591-5611
- A conversion board (H910-1148) is required.
- AF9708, AF9709/B; Contact details: Flash Support Group, Inc. TEL(81)53-428-8383

*10: For QFP-64 (MB89P589B) : NQPACK064SB, HQPACK064SB140 (each provided)

Support Hardware for F²MC-8FX Family

Support Hardware for F²MC-8FX Family

Development Tools					
Target Microcontroller			Fujitsu Microelectronics ICE		
Series name	Product name	Package (Lead pitch, body size)	Header board	MCU board	Equipment common to series
MB95100B	MB95107B *1 MB95F108B *1	LQFP-64P (0.5 mm, 10 × 10 mm) FPT-64P-M03	MB2146-220 Includes: NQPACK064SD *2 × 1 HQPACK064SD *2 × 1	MB2146-301A-E	<ul style="list-style-type: none"> • BGM adapter : MB2146-09A-E • Emulator debugger software : SOFTUNE • USB cable (bundled to MB2146-09A-E)
		LQFP-64P (0.65 mm, 12 × 12 mm) FPT-64P-M09	MB2146-221 Includes: NQPACK064SB *2 × 1 HQPACK064SB140 *2 × 1	MB2146-301A-E	
MB95100AM	MB95108AM *1 MB95F108AM *1	LQFP-64P (0.5 mm, 10 × 10 mm) FPT-64P-M03	MB2146-220 Includes: NQPACK064SD *2 × 1 HQPACK064SD *2 × 1	MB2146-303A-E	
		LQFP-64P (0.65 mm, 12 × 12 mm) FPT-64P-M09	MB2146-221 Includes: NQPACK064SB *2 × 1 HQPACK064SB140 *2 × 1	MB2146-303A-E	
MB95110B	MB95116B *1 MB95F118B *1	LQFP-48P (0.5 mm, 7 × 7 mm) FPT-48P-M26	MB2146-210 Includes: NQPACK048SD *2 × 1 HQPACK048SD *2 × 1	MB2146-301A-E	
		BCC-48P (0.5 mm, 7 × 7 mm) LCC-48P-M09	—	MB2146-301A-E	
		LQFP-52P (0.65 mm, 10 × 10 mm) FPT-52P-M01	MB2146-260 Includes: NQPACK052SB *2 × 1 HQPACK052SB *2 × 1	MB2146-303A-E	
MB95120	MB95F128D	LQFP-100P (0.5 mm, 14 × 14 mm) FPT-100P-M20	MB2146-250 Includes: NQPACK100SD *2 × 1 HQPACK100SD *2 × 1	MB2146-301A-E	
		QFP-100P (0.65 mm, 14 × 20 mm) FPT-100P-M06	MB2146-251 Includes: NQPACK100RB179 *2 × 1 HQPACK100RB179 *2 × 1		
MB95120MB	MB95F128MB	LQFP-100P (0.5 mm, 14 × 14 mm) FPT-100P-M05	MB2146-250 Includes: NQPACK100SD *2 × 1 HQPACK100SD *2 × 1	MB2146-303A-E	
		QFP-100P (0.65 mm, 14 × 20 mm) FPT-100P-M06	MB2146-251 Includes: NQPACK100RB179 *2 × 1 HQPACK100RB179 *2 × 1	MB2146-303A-E	
MB95130M	MB95136M *1 MB95F136M *4	SOP-28P (1.27 mm, 8.6 × 17.75 mm) FPT-28P-M17	MB2146-270 Includes: SSA-28YR1-M17 × 1	MB2146-303A-E	
MB95140	MB95F146	LQFP-32P (0.8 mm, 7 × 7 mm) FPT-32P-M21	MB2146-200 Includes: NQPACK032SA *2 × 1 HQPACK032SA *2 × 1	MB2146-301A-E	
MB95150M	MB95F156M	LQFP-48P (0.5 mm, 7 × 7 mm) FPT-48P-M26	MB2146-213 Includes: NQPACK048SD *2 × 1 HQPACK048SD *2 × 1	MB2146-303A-E	
		LQFP-52P (0.65 mm, 10 × 10 mm) FPT-52P-M01	MB2146-261 Includes: NQPACK052SB *2 × 1 HQPACK052SB *2 × 1		
MB95160M	MB95F168M	LQFP-64P (0.5 mm, 10 × 10 mm) FPT-64P-M24	MB2146-222 Includes: NQPACK064SD *2 × 1 HQPACK064SD *2 × 1	MB2146-303A-E	
		LQFP-64P (0.65 mm, 12 × 12 mm) FPT-64P-M23	MB2146-223 Includes: NQPACK064SB *2 × 1 HQPACK064SB *2 × 1		

*1: Under development

*2: The header board requires NQPACK.

Contact for details:

- USA: OESS Co. San Jose Office TEL(408)437-1582
- Europe Germany: OESS GmbH TEL(06106)2857890
- Tokyo Eletech Co. Ltd. TEL(81)3-3820-7141

*3: Compatible Flash Support Group ROM programmers: AF9708, AF9709/B: URL <http://www.j-fsg.co.jp/e/top.html>

*4: The signal conversion board is used instead of NQPACK.

Signal conversion board for MB95F136M: SSA-28YR1-M17

Contact for details:

- USA: OESS Co. San Jose Office TEL(408)437-1582
- Europe Germany: OESS GmbH TEL(06106)2857890
- Tokyo Eletech Co. Ltd. TEL(81)3-3820-7141

Support Hardware for F²MC-8FX Family

Development Tools	Equipment for Program to OTP/EPROM			Target Microcontroller
	Microcontroller subject Program	Parallel Programmer		
Evaluation Device (Lead pitch, body size)	Product name	Programmer (manufacturer)	IC Package Conversion Adapter (for program)	Product name
MB95FV100D-101 (The evaluation device has been mounted on the MCU board.)	MB95F108B FPT-64P-M03	Flash Support Group, Inc.	TEF110-108F35AP	MB95107B *1 MB95F108B *1
	MB95F108B FPT-64P-M09	Flash Support Group, Inc.	TEF110-108F36AP	
MB95FV100D-103 (The evaluation device has been mounted on the MCU board.)	MB95F108AM FPT-64P-M03	Flash Support Group, Inc.	TEF110-108F35AP	MB95108AM *1 MB95F108AM *1
	MB95F108AM FPT-64P-M09	Flash Support Group, Inc.	TEF110-108F36AP	
MB95FV100D-101 (The evaluation device has been mounted on the MCU board.)	MB95F118B FPT-48P-M26	Flash Support Group, Inc.	TEF110-118F37AP	MB95116B *1 MB95F118B *1
	MB95F118B LCC-48P-M09	Flash Support Group, Inc.	TEF110-118F41AP	
MB95FV100D-103 (The evaluation device has been mounted on the MCU board.)	MB95F118M FPT-52P-M01	Flash Support Group, Inc.	TEF110-95118PMC	MB95117M *1 MB95F118M
MB95FV100D-101 (The evaluation device has been mounted on the MCU board.)	MB95F128 FPT-100P-M20	Flash Support Group, Inc.	TEF110-95F128HSPFV	MB95F128D
	MB95F128 FPT-100P-M06	Flash Support Group, Inc.	TEF110-95F128HSPF	
MB95FV100D-103 (The evaluation device has been mounted on the MCU board.)	MB95F128MB FPT-100P-M05	Flash Support Group, Inc.	TEF110-95F128HSPFV	MB95F128MB
	MB95F128MB FPT-100P-M06	Flash Support Group, Inc.	TEF110-95F128HSPF	
MB95FV100D-103 (The evaluation device has been mounted on the MCU board.)	MB95F136M FPT-28P-M17	Flash Support Group, Inc.	TEF110-95F136HSPF	MB95136M *1 MB95F136M *4
MB95FV100D-101 (The evaluation device has been mounted on the MCU board.)	MB95F146 FPT-32P-M21	Flash Support Group, Inc.	TEF110-95F146	MB95F146
MB95FV100D-103 (The evaluation device has been mounted on the MCU board.)	MB95F156M FPT-48P-M26	Flash Support Group, Inc.	TEF110-95F156HPFV	MB95F156M
	MB95F156M FPT-52P-M01	Flash Support Group, Inc.	TEF110-95F156HPMC	
MB95FV100D-103 (The evaluation device has been mounted on the MCU board.)	MB95F168M FPT-64P-M24	Flash Support Group, Inc.	TEF110-95F168HPMC1	MB95F168M
	MB95F168M FPT-64P-M23	Flash Support Group, Inc.	TEF110-95F168HPMC	

Support Hardware for F²MC-16LX Family

Support Hardware for F²MC-16LX Family

Development Tools					
Target Microcontroller			Fujitsu Microelectronics ICE		Evaluation Device
Series name	Product name	Package (Lead pitch, body size)	Probe	Main unit, other	
MB90330A	MB90333A MB90F334A	LQFP-120P (0.4 mm, 14 × 14 mm) FPT-120P-M05	MB2132-491 *5		MB90V330A (PGA-299C)
		LQFP-120P (0.5 mm, 16 × 16 mm) FPT-120P-M21	MB2132-492 *5		
MB90335	MB90337 *1 MB90F337 *1	LQFP-64P (0.65 mm, 12 × 12 mm) FPT-64P-M09	MB2132-493 *5		MB90V330A (PGA-299C)
MB90340E	MB90341E *1 MB90341ES *1 MB90341CE *1 MB90341CES *1 MB90342E MB90342ES MB90342CE MB90342CES MB90F342E MB90F342ES MB90F342CE MB90F342CES MB90F343E *1 MB90F343ES *1 MB90F343CE *1 MB90F343CES *1 MB90F345E MB90F345ES MB90F345CE MB90F345CES MB90346E MB90346ES MB90346CE MB90346CES MB90F346E MB90F346ES MB90F346CE MB90F346CES MB90347E MB90347ES MB90347CE MB90347CES MB90F347E MB90F347ES MB90F347CE MB90F347CES MB90348E *1 MB90348ES *1 MB90348CE *1 MB90348CES *1 MB90349E MB90349ES MB90349CE MB90349CES MB90F349E MB90F349ES MB90F349CE MB90F349CES	LQFP-100P (0.5 mm, 14 × 14 mm) FPT-100P-M05	MB2147-581 *5	<ul style="list-style-type: none"> • Main unit : MB2147-01 • Adaptor board : MB2147-20 • Evaluation device : separately available • Emulator debugger software : SOFTUNE • RS-232C cable or USB cable or LAN cable 	MB90V340E-101 (1-clock system) or MB90V340E-102 (2-clock system) (PGA-299C)
		QFP-100P (0.65 mm, 14 × 20 mm) FPT-100P-M06	MB2147-582 *5		

Support Hardware for F²MC-16LX Family

Equipment for Program to Flash/OTP/EPROM				Target Microcontroller
Microcontroller subject Program	Parallel Programmer		Serial Programmer	Product name
Product name	Programmer (manufacturer)	IC Package Conversion Adapter (for program)	Programmer (manufacture)	
MB90F334A FPT-120P-M05	Flash Support Group	TEF110-334F22AP *8	TSUZUKI DENSAN • TF-WRITER Yokogawa Digital Computer • Main unit: AF2xx • Control modules compatible with various microcontrollers • Other options	MB90333A MB90F334A
MB90F334A FPT-120P-M21		TEF110-334F26AP *8		
MB90F337 FPT-64P-M09	Flash Support Group	TEF110-337F31AP *8		MB90337 *1 MB90F337 *1
MB90F342E MB90F342ES MB90F342CE MB90F342CES MB90F343E *1 MB90F343ES *1 MB90F343CE *1 MB90F343CES *1 MB90F345E MB90F345ES MB90F345CE MB90F345CES MB90F346E MB90F346ES MB90F346CE MB90F346CES MB90F347E MB90F347ES MB90F347CE MB90F347CES MB90F349E MB90F349ES MB90F349CE MB90F349CES FPT-100P-M05	Flash Support Group	TEF110-328F13AP-2 *8	Flash Support Group • Main unit: AF9101 (Under planning excluding MB90F347) Yokogawa Digital Computer • Main unit: AF2xx • Control modules compatible with various microcontrollers • Other options	MB90341E *1 MB90341ES *1 MB90341CE *1 MB90341CES *1 MB90342E MB90342ES MB90342CE MB90342CES MB90F342E MB90F342ES MB90F342CE MB90F342CES MB90F343E *1 MB90F343ES *1 MB90F343CE *1 MB90F343CES*1 MB90F345E MB90F345ES MB90F345CE MB90F345CES MB90F346E MB90F346ES MB90F346CE MB90F346CES MB90F347E MB90F347ES MB90F347CE MB90F347CES MB90F349E MB90F349ES MB90F349CE MB90F349CES
MB90F342E MB90F342ES MB90F342CE MB90F342CES MB90F343E *1 MB90F343ES *1 MB90F343CE *1 MB90F343CES *1 MB90F345E MB90F345ES MB90F345CE MB90F345CES MB90F346E MB90F346ES MB90F346CE MB90F346CES MB90F347E MB90F347ES MB90F347CE MB90F347CES MB90F349E MB90F349ES MB90F349CE MB90F349CES FPT-100P-M06	Flash Support Group	TEF110-328F12AP-2 *8		

Support Hardware for F²MC-16LX Family

Support Hardware for F²MC-16LX Family

Development Tools					
Target Microcontroller			Fujitsu Microelectronics ICE		Evaluation Device
Series name	Product name	Package (Lead pitch, body size)	Probe	Main unit, other	
MB90350E	MB90351E MB90351ES MB90351TE MB90351TES MB90352E MB90352ES MB90352TE MB90352TES MB90356E MB90356ES MB90356TE MB90356TES MB90357E MB90357ES MB90357TE MB90357TES	LQFP-64P (0.65 mm, 12 × 12 mm) FPT-64P-M23	MB2147-540 *2	<ul style="list-style-type: none"> Main unit : MB2147-01 Adaptor board : MB2147-20 Evaluation device : (separately available) Emulator debugger software : SOFTUNE RS-232C cable or USB cable or LAN cable 	MB90V340E-101/103 (1-clock system) MB90V340E-102/104 (2-clock system) (PGA-299C)
	MB90F351E MB90F351ES MB90F351TE MB90F351TES MB90F352E MB90F352ES MB90F352TE MB90F352TES MB90F356E MB90F356ES MB90F356TE MB90F356TES MB90F357E MB90F357ES MB90F357TE MB90F357TES	LQFP-64P (0.5 mm, 10 × 10 mm) FPT-64P-M24	MB2147-542		
MB90360E	MB90362E MB90362ES MB90362TE MB90362TES MB90F362E MB90F362ES MB90F362TE MB90F362TES MB90367E MB90367ES MB90367TE MB90367TES MB90F367E MB90F367ES MB90F367TE MB90F367TES	LQFP-48P (0.5 mm, 7 × 7 mm) FPT-48P-M26	MB2147-521 *2	<ul style="list-style-type: none"> Main unit : MB2147-01 Adaptor board : MB2147-10 Evaluation device : separately available Emulator debugger software : SOFTUNE RS-232C cable or USB cable or LAN cable 	MB90V340E-101/103 (1-clock system) MB90V340E-102/104 (2-clock system) (PGA-299C)
MB90370	MB90372 MB90F372	LQFP-144P (0.4mm, 16 × 16 mm) FPT-144P-M12	MB2132-471		
MB90375	MB90F377	LQFP-144P (0.4mm, 16 × 16 mm) FPT-144P-M12			MB90V370 (PGA-256C)
MB90378	MB90F378	LQFP-144P (0.4 mm, 16 × 16 mm) FPT-144P-M12	MB2132-471	<ul style="list-style-type: none"> Main unit : MB2147-01 Adaptor board : MB2147-20 Evaluation device : (separately available) Emulator debugger software : SOFTUNE RS-232C cable or USB cable or LAN cable 	MB90V378 (PGA-299C)

Support Hardware for F²MC-16LX Family

Equipment for Program to Flash/OTP/EPROM				Target Microcontroller
Microcontroller subject Program	Parallel Programmer		Serial Programmer	Product name
Product name	Programmer (manufacturer)	IC Package Conversion Adapter (for program)	Programmer (manufacture)	
MB90F351E MB90F351ES MB90F351TE MB90F351TES MB90F352E MB90F352ES MB90F352TE MB90F352TES MB90F356E MB90F356ES MB90F356TE MB90F356TES MB90F357E MB90F357ES MB90F357TE MB90F357TES FPT-64P-M23	Flash Support Group	TE110-352F30AP *8	Yokogawa Digital Computer • Main unit: AF2xx • Control modules compatible with various microcontrollers • Other options	MB90351E MB90351ES MB90351TE MB90351TES MB90352E MB90352ES MB90352TE MB90352TES MB90356E MB90356ES MB90356TE MB90356TES MB90357E MB90357ES MB90357TE MB90357TES MB90357TES MB90F351E MB90F351ES MB90F351TE MB90F351TES MB90F352E MB90F352ES MB90F352TE MB90F352TES MB90F356E MB90F356ES MB90F356TE MB90F356TES MB90F357E MB90F357ES MB90F357TE MB90F357TES
MB90F351E MB90F351ES MB90F351TE MB90F351TES MB90F352E MB90F352ES MB90F352TE MB90F352TES MB90F356E MB90F356ES MB90F356TE MB90F356TES MB90F357E MB90F357ES MB90F357TE MB90F357TES FPT-64P-M24	Flash Support Group	TEF110-90F352A		MB90F351E MB90F351ES MB90F351TE MB90F351TES MB90F352E MB90F352ES MB90F352TE MB90F352TES MB90F356E MB90F356ES MB90F356TE MB90F356TES MB90F357E MB90F357ES MB90F357TE MB90F357TES
MB90F362E MB90F362ES MB90F362TE MB90F362TES MB90F367E MB90F367ES MB90F367TE MB90F367TES FPT-48P-M26	Flash Support Group	TEF110-387F15AP-2 *8	Flash Support Group • Main unit: AF9101 Yokogawa Digital Computer • Main unit: AF2xx • Control modules compatible with various microcontrollers • Other options	MB90362E MB90362ES MB90362TE MB90362TES MB90F362E MB90F362ES MB90F362TE MB90F362TES MB90367E MB90367ES MB90367TE MB90367TES MB90F367E MB90F367ES MB90F367TE MB90F367TES
MB90F372 FPT-144P-M12	Flash Support Group	TE110-372F17AP *8	Not supported	MB90372 MB90F372
MB90F377 FPT-144P-M12	Flash Support Group	TE110-372F17AP *8	Not supported	MB90F377
MB90F378 FPT-144P-M12	Flash Support Group	TE110-372F17AP *8	Not supported	MB90F378

Support Hardware for F²MC-16LX Family

Support Hardware for F²MC-16LX Family

Development Tools					
Target Microcontroller			Fujitsu Microelectronics ICE		Evaluation Device
Series name	Product name	Package (Lead pitch, body size)	Probe	Main unit, other	
MB90385	MB90387 MB90387S MB90F387 MB90F387S	LQFP-48P (0.5 mm, 7 × 7 mm) FPT-48P-M26	MB2132-466 *5	<ul style="list-style-type: none"> Main unit : MB2147-01 Adaptor board : MB2147-10 Evaluation device : separately available Emulator debugger software : SOFTUNE RS-232C cable or USB cable or LAN cable 	MB90V495G (PGA-256C)
MB90390	MB90394HA MB90F394HA	LQFP-120P (0.5mm, 16 × 16 mm) FPT-120P-M21	MB2132-469 *5	<ul style="list-style-type: none"> Main unit : MB2147-01 Adaptor board : MB2147-20 Evaluation device : (separately available) Emulator debugger software : SOFTUNE RS-232C cable or USB cable or LAN cable 	MB90V390HB (PGA-299C)
MB90M405	MB90M407 MB90M407A MB90M408 MB90M408A MB90MF408 MB90MF408A	QFP-100P (0.6 5mm, 14 × 20 mm) FPT-100P-M06	MB2132-464 *5		MB90MV405 (PGA-256C)
MB90420G MB90425G	MB90423GA MB90423GB MB90423GC MB90F423GA MB90F423GB MB90F423GC MB90427GA MB90427GB MB90427GC MB90428GA MB90428GB MB90428GC MB90F428GA MB90F428GB MB90F428GC	QFP-100P (0.65mm, 14 × 20mm) FPT-100P-M06	MB2132-464 *5	<ul style="list-style-type: none"> Main unit : MB2147-01 Adaptor board : MB2147-10 Evaluation device : separately available Emulator debugger software : SOFTUNE RS-232C cable or USB cable or LAN cable 	MB90V420G (PGA-256C)
		LQFP-100P (0.5mm, 14 × 14mm) FPT-100P-M05	MB2132-496 *5		
MB90435	MB90437L MB90437LS MB90438L MB90438LS MB90439 MB90439S MB90F438L MB90F438LS MB90F439 MB90F439S	QFP-100P (0.65mm, 14 × 20mm) FPT-100P-M06	MB2132-464 *5		MB90V540G (PGA-256C)
		LQFP-100P (0.5mm, 14 × 14mm) FPT-100P-M05	MB2132-496 *5		
MB90440G	MB90443G *1 MB90F443G	QFP-100P (0.65mm, 14 × 20 mm) FPT-100P-M06	MB2132-464 *5	<ul style="list-style-type: none"> Main unit : MB2147-01 Adaptor board : MB2147-10 Evaluation device : separately available Emulator debugger software : SOFTUNE RS-232C cable or USB cable or LAN cable 	MB90V440G (PGA-256C)

Support Hardware for F²MC-16LX Family

Equipment for Program to Flash/OTP/EPROM				Target Microcontroller
Microcontroller subject Program	Parallel Programmer		Serial Programmer	Product name
Product name	Programmer (manufacturer)	IC Package Conversion Adapter (for program)	Programmer (manufacture)	
MB90F387 MB90F387S FPT-48P-M26	Flash Support Group	TEF110-387F15AP-2 *8	TSUZUKI DENSAN • TF-WRITER Yokogawa Digital Computer • Main unit: AF2xx	MB90387 MB90387S MB90F387 MB90F387S
MB90F394H FPT-120P-M21	Flash Support Group	TEF110-394F16AP *8	• Yokogawa Digital Computer • Main unit: AF2xx • Control modules compatible with various microcontrollers • Other options	MB90394HA MB90F394HA
MB90MF408 MB90MF408A FPT-100P-M06	Not supported	Not supported	Yokogawa Digital Computer • Main unit: AF2xx • Control modules compatible with various microcontrollers • Other options	MB90M407 MB90M407A MB90M408 MB90M408A MB90MF408 MB90MF408A
MB90F423GA MB90F423GB MB90F423GC MB90F428GA MB90F428GB MB90F428GC FPT-100P-M06	Minato Electronics	MF00-989B *6 MF05-989A *9	TSUZUKI DENSAN • TF-WRITER Yokogawa Digital Computer • Main unit: AF2xx • Control modules compatible with various microcontrollers • Other options	MB90423GA MB90423GB MB90423GC MB90F423GA MB90F423GB MB90F423GC MB90427GA MB90427GB MB90427GC MB90428GA MB90428GB MB90428GC MB90F428GA MB90F428GB MB90F428GC
	Flash Support Group	TEF110-553F01AP-2 *8		
	Data I/O	S5023		
MB90F423GA MB90F423GB MB90F423GC MB90F428GA MB90F428GB MB90F428GC FPT-100P-M05	Minato Electronics	MF00-709A *6 MF05-709B *9	Yokogawa Digital Computer • Main unit: AF2xx • Control modules compatible with various microcontrollers • Other options	MB90437L MB90437LS MB90438L MB90438LS MB90439 MB90439S MB90F438L MB90F438LS MB90F439 MB90F439S
	Flash Support Group	TEF110-580F03AP-2 *8		
	Data I/O	Not supported		
MB90F438L MB90F438LS MB90F439 MB90F439S FPT-100P-M06	Minato Electronics	MF00-989B *6 MF05-989A *9	Yokogawa Digital Computer • Main unit: AF2xx • Control modules compatible with various microcontrollers • Other options	MB90443G *1 MB90F443G
	Flash Support Group	TEF110-553F01AP-2 *8		
	Data I/O	S5023		
MB90F443G FPT-100P-M06	Minato Electronics	MF00-989B *6 MF05-989A *9	TSUZUKI DENSAN • TF-WRITER	MB90443G *1 MB90F443G
	Flash Support Group	TEF110-553F01AP-2 *8	Yokogawa Digital Computer • Main unit: AF2xx • Control modules compatible with various microcontrollers • Other options	
	Data I/O	S5023		

Support Hardware for F²MC-16LX Family

Support Hardware for F²MC-16LX Family

Development Tools					
Target Microcontroller			Fujitsu Microelectronics ICE		Evaluation Device
Series name	Product name	Package (Lead pitch, body size)	Probe	Main unit, other	
MB90455	MB90455 MB90455S MB90F455 MB90F455S MB90456 MB90456S MB90F456 MB90F456S MB90457 MB90457S MB90F457 MB90F457S	LQFP-48P (0.5mm, 7 × 7 mm) FPT-48P-M26	MB2132-466 *5	<ul style="list-style-type: none"> Main unit : MB2147-01 Adaptor board : MB2147-10 Evaluation device : separately available Emulator debugger software : SOFTUNE RS-232C cable or USB cable or LAN cable 	MB90V495G (PGA-256C)
MB90460	MB90462 MB90467 MB90F462	SH-DIP-64P DIP-64P-M01	MB2132-434	<ul style="list-style-type: none"> Main unit : MB2147-01 Adaptor board : MB2147-10 	MB90V460 (PGA-256C)
		QFP-64P (1.0mm, 14 × 20mm) FPT-64P-M06	MB2132-434 + 64SD-64QF-8L *3	<ul style="list-style-type: none"> Evaluation device : separately available Emulator debugger software : SOFTUNE 	
		LQFP-64P (0.65mm, 12 × 12mm) FPT-64P-M09	MB2132-461 *5	<ul style="list-style-type: none"> RS-232C cable or USB cable or LAN cable 	
MB90480B	MB90F481B MB90F482B	QFP-100P (0.65mm, 14 × 20 mm) FPT-100P-M06	MB2132-464 *5	<ul style="list-style-type: none"> Main unit : MB2147-01 Adaptor board : MB2147-20 Evaluation device : separately available 	MB90V480 (PGA-299C)
		LQFP-100P (0.5mm, 14 × 14mm) FPT-100P-M05	MB2132-496 *5		
MB90485B	MB90483C MB90487B MB90488B MB90F488B MB90F489B	QFP-100P (0.65mm, 14 × 20 mm) FPT-100P-M06	MB2132-464 *5	<ul style="list-style-type: none"> Emulator debugger software : SOFTUNE RS-232C cable or USB cable or LAN cable 	MB90V485B (PGA-299C)
		LQFP-100P (0.5mm, 14 × 14mm) FPT-100P-M05	MB2132-496 *5		
MB90495G	MB90497G MB90F497G MB90F498G	QFP-64P (1.0mm, 14 × 20mm) FPT-64P-M06	MB2132-434 + 64SD-64QF-8L *3	<ul style="list-style-type: none"> Main unit : MB2147-01 Adaptor board : MB2147-10 Evaluation device : separately available 	MB90V495G (PGA-256C)
		LQFP-64P (0.65mm, 12 × 12mm) FPT-64P-M09	MB2132-461 *5	<ul style="list-style-type: none"> Emulator debugger software : SOFTUNE RS-232C cable or USB cable or LAN cable 	

Support Hardware for F²MC-16LX Family

Equipment for Program to Flash/OTP/EPROM				Target Microcontroller
Microcontroller subject Program	Parallel Programmer		Serial Programmer	Product name
Product name	Programmer (manufacturer)	IC Package Conversion Adapter (for program)	Programmer (manufacture)	
MB90F455 MB90F455S MB90F456 MB90F456S MB90F457 MB90F457S FPT-48P-M26	Flash Support Group	TEF110-387F15AP-2 *8	Yokogawa Digital Computer • Main unit: AF2xx • Control modules compatible with various microcontrollers • Other options	MB90455 MB90455S MB90F455 MB90F455S MB90456 MB90456S MB90F456 MB90F456S MB90457 MB90457S MB90F457 MB90F457S
MB90F462 DIP-64P-M01	Minato Electronics	MF13-787B *6	TSUZUKI DENSAN • TF-WRITER Yokogawa Digital Computer • Main unit: AF2xx • Control modules compatible with various microcontrollers • Other options	MB90462 MB90467 MB90F462
	Flash Support Group	TEF110-562F05AP-2 *8		
	Data I/O	Not supported		
MB90F462 FPT-64P-M06	Minato Electronics	MF13-785B *6		
	Flash Support Group	TEF110-562F06AP-2 *8		
	Data I/O	Not supported		
MB90F462 FPT-64P-M09	Minato Electronics	MF13-786B *6		
	Flash Support Group	TEF110-562F07AP-2 *8		
	Data I/O	Not supported		
MB90F481 MB90F482 MB90F488 MB90F489 FPT-100P-M06	Minato Electronics	MF00-989B *6 MF05-989A *9		
	Flash Support Group	TEF110-553F01AP-2 *8		
	Data I/O	S5023 *7		
MB90F481 MB90F482 MB90F488 MB90F489 FPT-100P-M05	Minato Electronics	MF00-709A *6 MF05-709B *9		
	Flash Support Group	TEF110-580F03AP-2 *8		
	Data I/O	Not supported		
MB90F488B FPT-100P-M06	Minato Electronics	MF00-989B *6 MF05-989A *9		
	Flash Support Group	TEF110-553F01AP-2 *8		
	Data I/O	S5023 *7		
MB90F488B FPT-100P-M05	Minato Electronics	MF00-709A *6 MF05-709B *9		
	Flash Support Group	TEF110-580F03AP-2 *8		
	Data I/O	Not supported		
MB90F497G MB90F498G FPT-64P-M06	Minato Electronics	MF13-785B *6 MF05-785B *9	TSUZUKI DENSAN • TF-WRITER Yokogawa Digital Computer • Main unit: AF2xx • Control modules compatible with various microcontrollers • Other options	MB90483C MB90487B MB90488B MB90F488B MB90F489B
	Flash Support Group	TEF110-562F06AP-2 *8		
	Data I/O	Not supported		
MB90F497G MB90F498G FPT-64P-M09	Minato Electronics	MF13-786B *6 MF05-786B *9		
	Flash Support Group	TEF110-562F07AP-2 *8		
	Data I/O	Not supported		

Support Hardware for F²MC-16LX Family

Support Hardware for F²MC-16LX Family

Development Tools					
Target Microcontroller			Fujitsu Microelectronics ICE		Evaluation Device
Series name	Product name	Package (Lead pitch, body size)	Probe	Main unit, other	
MB90520A MB90520B	MB90522A MB90522B MB90523A MB90523B MB90F523A MB90F523B	QFP-120P (0.5mm, 20 × 20mm) FPT-120P-M13	MB2132-468 *5	<ul style="list-style-type: none"> • Main unit : MB2147-01 • Adaptor board : MB2147-10 • Evaluation device : separately available • Emulator debugger software : SOFTUNE • RS-232C cable or USB cable or LAN cable 	MB90V520A (PGA-256C)
		LQFP-120P (0.4mm, 14 × 14mm) FPT-120P-M05	MB2132-498 *5		
MB90540 MB90540G	MB9543G MB90543GS MB90F543 MB90F543G MB90F543GS	QFP-100P (0.65mm, 14 × 20mm) FPT-100P-M06	MB2132-464 *5		MB90V540 MB90V540G (PGA-256C)
		LQFP-100P (0.5mm, 14 × 14mm) FPT-100P-M05	MB2132-496 *5		
MB90545 MB90545G	MB90F546G MB90F546GS MB90547G MB90547GS MB90548G MB90548GS MB90F548G MB90F548GL MB90F548GLS MB90F548GS MB90549G MB90549GS M90F549 MB90F549G MB90F549GS	QFP-100P (0.65mm, 14 × 20mm) FPT-100P-M06	MB2132-464 *5		MB90V540 MB90V540G (PGA-256C)
		LQFP-100P (0.5mm, 14 × 14mm) FPT-100P-M05	MB2132-496 *5		
MB90550A MB90550B	MB90552A MB90552B MB90T552A MB90553A MB90553B MB90T553A MB90P553A MB90F553A	QFP-100P (0.65mm, 14 × 20mm) FPT-100P-M06	MB2132-464 *5		MB90V550A (PGA-256C)
		LQFP-100P (0.5mm, 14 × 14mm) FPT-100P-M05	MB2132-496 *5		
MB90560	MB90561 MB90561A MB90562 MB90562A MB90F562 MB90F562B	SH-DIP-64P DIP-64P-M01	MB2132-434	MB90V560 (PGA-256C)	
		LQFP-64P (0.65mm, 12 × 12mm) FPT-64P-M09	MB2132-461 *5		
		QFP-64P (1.0mm, 14 × 20mm) FPT-64P-M06	MB2132-434 + 64SD-64QF-8L *3		

Support Hardware for F²MC-16LX Family

Equipment for Program to Flash/OTP/EPROM				Target Microcontroller	
Microcontroller subject Program	Parallel Programmer		Serial Programmer	Product name	
Product name	Programmer (manufacturer)	IC Package Conversion Adapter (for program)	Programmer (manufacture)		
MB90F523A MB90F523B FPT-120P-M13	Minato Electronics	MF00-23B *6 MF05-23B *9	TSUZUKI DENSAN • TF-WRITER Yokogawa Digital Computer • Main unit: AF2xx • Control modules compatible with various microcontrollers • Other options	MB90522A MB90522B MB90523A MB90523B MB90F523A MB90F523B	
	Flash Support Group	TEF110-574F02AP-2 *8			
	Data I/O	S5024			
MB90F523A MB90F523B FPT-120P-M05	Minato Electronics	MF00-22B *6 MF05-22B *9			
	Flash Support Group	TEF110-523F08AP-2 *8			
	Data I/O	Not supported			
MB90F543 MB90F543G/GS FPT-100P-M06	Minato Electronics	MF00-989B *6 MF05-989A *9		TSUZUKI DENSAN • TF-WRITER Yokogawa Digital Computer • Main unit: AF2xx • Control modules compatible with various microcontrollers • Other options	MB90543G MB90543GS MB90F543 MB90F543G MB90F543GS
	Flash Support Group	TEF110-553F01AP-2 *8			
	Data I/O	S5023			
MB90F543 MB90F543G/GS FPT-100P-M05	Minato Electronics	MF00-709A *6 MF05-709B *9			
	Flash Support Group	TEF110-580F03AP-2 *8			
	Data I/O	Not supported			
MB90F546G/GS MB90F548G/GS MB90F548GL/GLS MB90549G/GS FPT-100P-M06	Minato Electronics	MF00-989B *6 MF05-989A *9	TSUZUKI DENSAN • TF-WRITER Yokogawa Digital Computer • Main unit: AF2xx • Control modules compatible with various microcontrollers • Other options		MB90F546G MB90F546GS MB90547G MB90547GS MB90548G MB90548GS MB90F548GL MB90F548GLS MB90F548GS MB90549G MB90549GS MB90F549 MB90F549G MB90F549GS
	Flash Support Group	TEF110-553F01AP-2 *8			
	Data I/O	S5023			
MB90F546G/GS MB90F548G/GS MB90F548GL/GLS MB90F549G/GS FPT-100P-M05	Minato Electronics	MF00-709A *6 MF05-709B *9			
	Flash Support Group	TEF110-580F03AP-2 *8			
	Data I/O	Not supported			
MB90P553A FPT-100P-M06	General-purpose EPROM Programmer capable of programming to MBM27C1000	ROM-100QF-32DP-16L *3		—	
MB90F553A FPT-100P-M06	Minato Electronics	MF00-989B *6 MF05-989A *9		TSUZUKI DENSAN • TF-WRITER Yokogawa Digital Computer • Main unit: AF2xx • Control modules compatible with various microcontrollers • Other options	MB90552A MB90552B MB90T552A MB90553A MB90553B MB90T553A MB90P553A MB90F553A
	Flash Support Group	TEF110-553F01AP-2 *8			
	Data I/O	S5023			
MB90F553A FPT-100P-M05	Minato Electronics	MF00-709A *6 MF05-709B *9			
	Flash Support Group	TEF110-580F03AP-2 *8			
	Data I/O	Not supported			
MB90F562 MB90F562B DIP-64P-M01	Minato Electronics	MF13-787B *6 MF05-787B *9	TSUZUKI DENSAN • TF-WRITER Yokogawa Digital Computer • Main unit: AF2xx • Control modules compatible with various microcontrollers • Other options		MB90561 MB90561A MB90562 MB90562A MB90F562 MB90F562B
	Flash Support Group	TEF110-562F05AP-2 *8			
	Data I/O	Not supported			
MB90F562 MB90F562B FPT-64P-M09	Minato Electronics	MF13-786B *6 MF05-786B *9			
	Flash Support Group	TEF110-562F07AP-2 *8			
	Data I/O	Not supported			
MB90F562 MB90F562B FPT-64P-M06	Minato Electronics	MF13-785B *6			
	Flash Support Group	TEF110-562F06AP-2 *8			
	Data I/O	Not supported			

Support Hardware
for F²MC-16LX Family

Support Hardware for F²MC-16LX Family

Development Tools					
Target Microcontroller			Fujitsu Microelectronics ICE		Evaluation Device
Series name	Product name	Package (Lead pitch, body size)	Probe	Main unit, other	
MB90565	MB90567 MB90568 MB90F568	QFP-64P (1.0mm, 14 × 20mm) FTP-64P-M06	MB2132-434 + 64SD-64QF-8L		MB90V560 (PGA-256C)
		LQFP-64P (0.65mm, 12 × 12mm) FTP-64P-M09	MB2132-461 *5		
MB90570A/C	MB90574C MB90F574 MB90F574A	LQFP-120P (0.5mm, 16 × 16mm) FPT-120P-M21	MB2132-497 *5	<ul style="list-style-type: none"> • Main unit : MB2147-01 • Adaptor board : MB2147-10 • Evaluation device : separately available 	MB90V570 MB90V570A (PGA-256C)
	MB90573 MB90574 MB90574C MB90F574 MB90F574A	QFP-120P (0.5mm, 20 × 20mm) FPT-120P-M13	MB2132-468 *5		
	MB90573 MB90574 MB90F574 MB90F574A	LQFP-120P (0.4mm, 14 × 14mm) FPT-120P-M05	MB2132-498 *5		
MB90580C	MB90583C MB90583CA MB90F583C MB90F584C MB90F584CA MB90587C MB90587CA	QFP-100P (0.65mm, 14 × 20mm) FPT-100P-M06	MB2132-464 *5	<ul style="list-style-type: none"> • Emulator debugger software : SOFTUNE • RS-232C cable or USB cable or LAN cable 	MB90V580B (PGA-256C)
		LQFP-100P (0.5mm, 14 × 14mm) FPT-100P-M05	MB2132-496 *5		
MB90590G	MB90591G MB90F591G MB90594G MB90F594G	QFP-100P (0.65mm, 14 × 20mm) FPT-100P-M06	MB2132-464 *5		MB90V590G (PGA-256C)
MB90595G	MB90598G MB90F598G	QFP-100P (0.65mm, 14 × 20mm) FPT-100P-M06	MB2132-464 *5		MB90V595G (PGA-256C)
MB90800	MB90803 MB90F803 MB90804 *2 MB90F804 MB90F809	QFP-100P (0.65 mm, 14 × 20 mm) FPT-100P-M06	MB2147-582 *5	<ul style="list-style-type: none"> • Main unit : MB2147-01 • Adaptor board : MB2147-20 • Evaluation device : (separately available) • Emulator debugger software : SOFTUNE • RS-232C cable or USB cable or LAN cable 	MB90V800-101 (Single clock) MB90V800-201 (Dual clock) (PGA-299C)
MB90820	MB90822 MB90F822 MB90F823	QFP-80P (0.8 mm, 14 × 20 mm) FPT-80P-M06	MB2147-560 *5		
		LQFP-80P (0.5 mm, 12 × 12 mm) FPT-80P-M05	MB2147-561 *5		
MB90860E/ES	MB90867E MB90867ES MB90F867E MB90F867ES	LQFP-100P (0.5 mm, 14 × 14 mm) FPT-100P-M05	MB2147-581 *5		MB90V820 (PGA-299C)
		QFP-100P (0.65 mm, 14 × 20 mm) FPT-100P-M06	MB2147-582 *5		

Support Hardware for F²MC-16LX Family

Equipment for Program to Flash/OTP/EPROM				Target Microcontroller
Microcontroller subject Program	Parallel Programmer		Serial Programmer	Product name
Product name	Programmer (manufacturer)	IC Package Conversion Adapter (for program)	Programmer (manufacture)	
MB90F568 FPT-64P-M06	Minato Electronics	MF13-785B * ⁶ MF05-785B * ⁹	TSUZUKI DENSAN • TF-WRITER Yokogawa Digital Computer • Main unit: AF2xx • Control modules compatible with various microcontrollers • Other options	MB90567 MB90568 MB90F568
	Flash Support Group	TEF110-562F06AP-2 * ⁸		
	Data I/O	Not supported		
MB90F568 FPT-64P-M09	Minato Electronics	MF13-786B * ⁶ MF05-786B * ⁹		
	Flash Support Group	TEF110-562F07AP-2 * ⁸		
	Data I/O	Not supported		
MB90F574A FPT-120P-M21	Minato Electronics	MF00-729B * ⁶ MF05-729B * ⁹		
	Flash Support Group	TEF110-574F04AP-2 * ⁸		
	Data I/O	Not supported		
MB90F574A FPT-120-M13	Minato Electronics	MF00-23B * ⁶ MF05-23B * ⁹		
	Flash Support Group	TEF110-574F02AP-2 * ⁸		
	Data I/O	S5024 * ⁷		
MB90F574A FPT-120P-M05	Minato Electronics	MF00-22B * ⁶		
	Flash Support Group	TEF110-523F08AP-2 * ⁸		
	Data I/O	Not supported		
MB90F583C MB90F583CA MB90F584C MB90F584CA FPT-100P-M06	Minato Electronics	MF00-989B * ⁶ MF05-989A * ⁹		
	Flash Support Group	TEF110-553F01AP-2 * ⁸		
	Data I/O	S5023 * ⁷		
MB90F583C MB90F583CA MB90F584C MB90F584CA FPT-100P-M05	Minato Electronics	MF00-709A * ⁶ MF05-709B * ⁹		
	Flash Support Group	TEF110-580F03AP-2 * ⁸		
	Data I/O	Not supported		
MB90F591G MB90F594G FPT-100P-M06	Minato Electronics	MF00-989B * ⁶ MF05-989A * ⁹		
	Flash Support Group	TEF110-553F01AP-2 * ⁸		
	Data I/O	S5023 * ⁷		
MB90F598G FPT-100P-M06	Minato Electronics	MF00-989B * ⁶ MF05-989A * ⁹		
	Flash Support Group	TEF110-553F01AP-2 * ⁸		
	Data I/O	S5023 * ⁷		
MB90F803 MB90F804 MB90F809 FPT-100P-M06	Flash Support Group	TEF110-328F12AP-2 * ⁸		
MB90F822A MB90F823A FPT-80P-M06	Flash Support Group	TEF110-822F27AP		
MB90F822A MB90F823A FPT-80P-M05	Flash Support Group	TEF110-822F28AP		
MB90F822A MB90F823A FPT-80P-M11	Flash Support Group	TEF110-822F32AP		
MB90F867E MB90F867ES FPT-100P-M05	Flash Support Group	TEF110-328F13AP-2		
MB90F867E MB90F867ES FPT-100P-M06	Flash Support Group	TEF110-328F12AP-2 * ⁸		

Support Hardware for F²MC-16LX Family

Support Hardware for F²MC-16LX Family

Development Tools					
Target Microcontroller			Fujitsu Microelectronics ICE		Evaluation Device
Series name	Product name	Package (Lead pitch, body size)	Probe	Main unit, other	
MB90880	MB90882 MB90882S MB90883 MB90883S MB90884 MB90884S	LQFP-100P (0.5 mm, 14 × 14 mm) FPT-100P-M20	MB2147-581 *5	<ul style="list-style-type: none"> Main unit : MB2147-01 Adaptor board : MB2147-20 Evaluation device : (separately available) Emulator debugger software : SOFTUNE RS-232C cable or USB cable or LAN cable 	MB90V880A
	MB90F882 MB90F882S MB90F883A MB90F883AS MB90F884A MB90F884AS	QFP-100P (0.65 mm, 14 × 20 mm) FPT-100P-M06	MB2147-582 *5		
MB90895	MB90F897 MB90F897S	LQFP-48P (0.5 mm, 7 × 7 mm) FPT-48P-M26	MB2132-466 *5	<ul style="list-style-type: none"> Main unit : MB2147-01 Adaptor board : MB2147-10 Evaluation device : (separately available) Emulator debugger software : SOFTUNE RS-232C cable or USB cable or LAN cable 	MB90V495G (PGA-256C)
MB90920	MB90F922 MB90F922S	LQFP-120P (0.5 mm, 16 × 16 mm) FPT-120P-M21	MB2132-469	<ul style="list-style-type: none"> Main unit : MB2147-01 Adaptor board : MB2147-20 Evaluation device : (separately available) Emulator debugger software : SOFTUNE RS-232C cable or USB cable or LAN cable 	MB90V920 (PGA-299C)
MB90945	MB90947A MB90F946A MB90F947A MB90F949A	QFP-100P (0.65 mm, 14 × 20 mm) FPT-100P-M06	MB2147-583		MB90V390HB (PGA-299C)
		LQFP-100P (0.5 mm, 14 × 14 mm) FPT-100P-M05	MB2147-584		
MB90960	MB90F962 MB90F962S	LQFP-48P (0.5 mm, 7 × 7 mm) FPT-48P-M26	MB2147-5421		MB90V340E (PGA-299C)
MB90980	MB90F983	LQFP-64P (0.5 mm, 10 × 10 mm) FPT-64P-M03	MB2147-541 *5	MB90V485B (PGA-299C)	

*1 : Under development

*2 : Being planned

*3 : The IC package conversion adapter provided by Sunhayato is required for connecting the probe cable (separately available).

100QF-100SQF-16F : For QFP-100 (0.65mm, 14 × 20mm) to SQFP-100 (0.5mm, 14 × 14mm)

64SD-64QF2-8L : For SHDIP-64 to QFP-64

Sales Info: Advanced Interconnectics <http://advintcorp.com>

*4 : The Yamaichi Electronics IC socket is always required for connecting each probe cable (separately available).

IC149-100-14-B5 (_ = "0" positioning post unavailable, _ = "1" positioning post available) for QFP-100 (lead pitch : 0.65mm, body size : 14 × 20mm)

Sales Info:

• USA: Yamaichi Electronics Inc. TEL(408)4520797

• Europe Denmark: Wlmatok A.S. TEL(65)351446

England: Radiatron Components Ltd. TEL(01)8911221

AB Connector Ltd. TEL(0604)712000

Finland: Dualtek Oy TEL(80)8019911

France: Manudax-France TEL(1)4342-2050

Germany: Macrotron AG TEL(089)4208148

Glyn GmbH TEL:(49)61278077

Connector Service GmbH TEL:(089)429277

Italy: Eurosab International s.r.l TEL(02)93169781

Spain: S.A Generalde Imporciones Electronicas TEL(1)416-92-61

Sweden: Bexab Electronics TEL(08)7680560

Switzerland: Slcovend AG TEL(01)8303161

• Asia Singapore: Yamco Electronics Pte Ltd. TEL(336)6522

Korea: Asia Yamaichi Electronics, Inc. TEL(02)482-7263

Taiwan: Sing Way Co. TEL:(02)718-5971

Joung Lai Trading Co. Ltd. TEL:(02)754-1022

For IC sockets, it should be noted that there is a slight difference in footprint size between these and other mass-produced packages. Therefore, caution is required in designing the footprint of the print board.

Support Hardware for F²MC-16LX Family

Equipment for Program to Flash/OTP/EPROM				Target Microcontroller
Microcontroller subject Program	Parallel Programmer		Serial Programmer	Product name
Product name	Programmer (manufacturer)	IC Package Conversion Adapter (for program)	Programmer (manufacture)	
MB90F882 MB90F882S MB90F883A MB90F883AS MB90F884A MB90F884AS FPT-100P-M05	Flash Support Group	TEF110-328F13AP-2 *8	Yokogawa Digital Computer • Main unit: AF2xx • Control modules compatible with various microcontrollers • Other options	MB90882 MB90882S MB90883 MB90883S MB90884 MB90884S MB90F882 MB90F882S MB90F883A MB90F883AS MB90F884A MB90F884AS
MB90F882 MB90F882S MB90F883A MB90F883AS MB90F884A MB90F884AS FPT-100P-M06	Flash Support Group	TEF110-328F12AP-2 *8		MB90F882 MB90F882S MB90F883A MB90F883AS MB90F884A MB90F884AS
MB90F897 MB90F897S FPT-48P-M26	Flash Support Group	TEF110-387F15AP		MB90F897 MB90F897S
MB90F922 MB90F922S FPT-64P-M03	Flash Support Group	TEF110-394F16AP		MB90F922 MB90F922S
MB90F946A MB90F947A MB90F949A FPT-100P-M06	Flash Support Group	TEF110-328F12AP-2		MB90947A MB90F946A MB90F947A MB90F949A
MB90F946A MB90F947A MB90F949A FPT-100P-M05	Flash Support Group	TEF110-328F13AP-2		
MB90F962 MB90F962S FPT-48P-M26	Flash Support Group	TEF110-387F15AP-2	-	MB90F962 MB90F962S
MB90F983 FPT-64P-M03	Flash Support Group	TEF110-90F983	Yokogawa Digital Computer • Main unit: AF2xx • Control modules compatible with various microcontrollers • Other options	MB90F983

*5: TQPACK and NQPACK required for the connecting target of probe cable:

- NQPACK048SD and HQPACK048SD (attached) for LQFP-48 (lead pitch: 0.5 mm; body size: 7 × 7 mm)
 - NQPACK064SB and HQPACK064SB140 (attached) for LQFP-64 (lead pitch: 0.65 mm; body size: 12 × 12 mm)
 - NQPACK064SD-ND and HQPACK064SD (attached) for LQFP-64 (lead pitch: 0.5 mm; body size: 10 × 10 mm)
 - NQPACK080RA and HQPACK080RA (attached) for QFP-80 (lead pitch: 0.8 mm; body size: 14 × 20 mm)
 - NQPACK080SB and HQPACK080SB160 (attached) for LQFP-80 (lead pitch: 0.65 mm; body size: 14 × 14 mm)
 - NQPACK080SD and HQPACK080SD (attached) for LQFP-80 (lead pitch: 0.5 mm; body size: 12 × 12 mm)
 - NQPACK100RB179 and HQPACK100RB179 (attached) for QFP-100 (lead pitch: 0.65 mm; body size: 14 × 20 mm)
 - NQPACK100SD-ND and HQPACK100SD (attached) for LQFP-100 (lead pitch: 0.5 mm; body size: 14 × 14 mm)
 - NQPACK120SD220 and HQPACK120SD226 (attached) for QFP-120 (lead pitch: 0.5 mm; body size: 20 × 20 mm)
 - TQPACK120/144SD and TQSOCKET120/144SDP (attached) for QFP-120 (lead pitch: 0.5 mm; body size: 20 × 20 mm)
 - NQPACK120SD and HQPACK120SD (attached) for QFP-120 (lead pitch: 0.5 mm; body size: 16 × 16 mm)
 - NQPACK120SE and HQPACK120SE (attached) for LQFP-120 (lead pitch: 0.4 mm; body size: 14 × 14 mm)
- Caution: For the TQPACK and NQPACK, it should be noted that there is a slight difference in footprint size between these and other mass-produced packages.
Therefore, caution is required in designing the footprint of the print board.

Sales Info:

- USA: OESS Co. San Jose Office TEL(408)437-1582
- Europe Germany: OESS GmbH TEL(06106)2857890

*6: Compatible Minato Electronics ROM programmers: MODEL 1890A (Ver. 2.5 or later) + OU910 (Ver. 4.32r or later), MODEL 1893 (Ver. 1.10l or higher), MODEL 1931 (Ver. 1.10l or higher), MODEL 1930 + SU3000LX (Ver. 4.10l or higher);
Contact details: TEL (81-45) 591-5611; FAX (81-45) 592-2854

*7: Compatible Data I/O ROM programmers: OPTIMA, Dual-Package, OCTAL, QUAD: TEL(81-3) 3779-2151

*8: Compatible Flash Support Group ROM programmers: AF9708, AF9709/B: URL <http://www.j-fsg.co.jp/e/top.html>

*9: Adaptor for MODEL-1940

Support Hardware for FR Family

Support Hardware for FR Family

Target Microcontroller		Development Tools		
Product name	Package (Lead pitch, body size) Package code	Fujitsu Microelectronics ICE		
		Adapter, header	Main unit, other	- Evaluation Device - Package - DSU type
MB91101A	LQFP-100 (0.5mm,14 × 14mm) FPT-100P-M05	- Adapter unit: MB2197-101 *2 Note: Yamaichi Electronics IC socket is required separately (Option: IC149-100-□25-B5).	- Main unit: MB2197-01 - DSU cable: MB2197-10 - Evaluation device : separately available - Option ROM alternate unit: MB2197-90 - RS232C cable or LAN cable - Debugger software: SOFTUNE	- MB91V101A - PGA135 - DSU2
	QFP-100 (0.65mm,14 × 20mm) FPT-100P-M06	- Adapter unit: MB2197-102 *2 Note: Yamaichi Electronics IC socket is required separately (Option: IC149-100-□14-B5).		
MB91107A MB91108	LQFP-120 (0.5mm,16 × 16mm) FPT-120P-M21	- Adapter unit: MB2197-103 *3 Note: Tokyo Eletech IC socket is required separately (1-set is bundled.: NQPACK120SD, HQPACK120SD) .		- MB91V108 - PGA135 - DSU2
MB91121	LQFP-120 (0.5mm,16 × 16mm) FPT-120P-M21	- Adapter unit: MB2197-103 *3 Note: Tokyo Eletech IC socket is required separately (1-set is bundled.: NQPACK120SD, HQPACK120SD).		
MB91F127 MB91F128	LQFP-100 (0.5 mm, 14 × 14 mm) FPT-100P-M05	- Adapter board: MB2197-160 - Header: MB2197-162 *3 Note: Tokyo Eletech IC socket is required separately (1-set is bundled.: NQPACK100SD-ND, HQPACK100SD) .		- MB91FV129 - PGA299 - DSU3
MB91133 MB91F133A	LQFP-144 (0.5 mm,20 × 20 mm) FPT-144P-M08	- Adapter board: MB2197-130 - Header: MB2197-135 *3 Note: Tokyo Eletech IC socket is required separately (1-set is bundled.: NQPACK144SD-ND, HQPACK144SD) .		
MB91151A	LQFP-144 (0.5mm,20 × 20mm) FPT-144P-M08	- Adapter board: MB2197-150 - Header: MB2197-155 *3 Note: Tokyo Eletech IC socket is required separately (1-set is bundled.: NQPACK144SD-ND, HQPACK144SD) .	- Main unit: MB2198-01 - DSU cable: MB2198-10 - Evaluation device: separately avail- able - RS232C cable or USB cable or LAN cable - Debugger software: SOFTUNE	- MB91FV130 - PGA299 - DSU3
MB91154 MB91155 MB91F155A	LQFP-144 (0.5mm,20 × 20mm) FPT-144P-M08	- Adapter board: MB2197-150 - Header: MB2197-155 *3 Note: Tokyo Eletech IC socket is required separately (1-set is bundled.: NQPACK144SD-ND, HQPACK144SD) .		- MB91FV150 - PGA299 - DSU3
MB91F158	LQFP-120 (0.4mm, 14 × 14mm) FPT-120P-M05	- Adapter board: MB2197-150 - Header: MB2197-153 Note: Tokyo Eletech IC socket is required separately (1-set is bundled.: NQPACK120SE, HQPACK120SE) .	- Main unit: MB2198-01 - DSU cable: MB2198-10 - Evaluation device: separately avail- able - RS232C cable or USB1.1 cable or LAN cable: Commercial product - Debugger software: SOFTUNE	- MB91FV150 - PGA299 - DSU3

Support Hardware for FR Family

Development Tools		Equipment for Program to Flash				Target Microcontroller
Evaluation board		Microcontroller Subject to Program	Parallel programmer		Serial programmer	
Fujitsu Microelectronics	Sunhayato Corp.	Product name (Package)	Maker name	Programming adapter	Maker name Product name	Product name
1) - Main board: MB91906EB - Daughter board: MB91901EB *: Simple substance use is possible. (Evaluation device is with mounting. Connection use of ICE is possible (DSU) .	Not supported	—	—	—	—	MB91101A
2) - Main board: MB91906EB - Daughter board: MB91902EB *: Simple substance use is possible. (Option: MB91101A , Connection use of SOPHIA SYSTEMS or YDC ICE is possible. (NQPACK socket Note: Fujitsu ICE is not connectable (Yamaichi Electronics socket).		—	—	—	—	
3) - Main board: MB91906EB - Simple target for ICE: MB91903EB *: Simple substance use is possible. (Evaluation device is with mounting. Connection use of ICE is possible (DSU) .	Not supported	—	—	—	—	
- Main board: MB91906EB - Daughter board: MB91907EB *: Connection use of ICE is possible (NQPACK socket is used).	Not supported	—	—	—	—	MB91107A MB91108
- Main board: MB91906EB - Daughter board: MB91907EB *: Simple substance use is possible (Option: MB911121 , Connection use of ICE is possible (NQPACK socket is used).	Not supported	—	—	—	—	MB91121
- Main board: MB91906EB - Daughter board: MB91910EB	Not supported	MB91F128 FPT-100P-M05	Flash Support Group *5	TE110-123F14AP	Yokogawa Digital Computer NETIMPRESS *6	MB91F127 MB91F128
- Main board: MB91906EB - Daughter board: MB91908EB *: Simple substance use is possible (Option: MB91F133A , Connection use of ICE is possible (NQPACK socket is used).	Not supported	MB91F133A FPT-144P-M08	Minato Electronics *4	MF00-871 (for MODEL1893/1931 MF05-871 (for MODEL1940)	Yokogawa Digital Computer NETIMPRESS *6	MB91133 MB91F133A
- Main board: MB91906EB - Daughter board: MB91911EB *: Simple substance use is possible (Option: MB91F155A , Connection use of ICE is possible (NQPACK socket is used).	Not supported	—	—	—	—	MB91151A
- Main board: MB91906EB - Daughter board: MB91911EB *: Simple substance use is possible. (Option: MB91F155A , Connection use of ICE is possible (NQPACK socket is used).	Not supported	MB91F155A FPT-144P-M08	Minato Electronics *4	MF13-1003A (for MODEL1893/1931 MF05-103 (for MODEL1940)	Yokogawa Digital Computer NETIMPRESS *6	MB91154 MB91155 MB91F155A
Flash Support Group *5			TE110-155F10AP			
- Main board: MB91906EB - Daughter board: MB91911EB *: Simple substance use is possible. (Option: MB91F155A , Connection use of ICE is possible (NQPACK socket is used).	Not supported	MB91F158 FPT-120P-M05	Minato Electronics *4	MF13-1271 (for MODEL1893/1931) MF05-1271 (for MODEL1940)	—	MB91F158

Support Hardware for FR Family

Target Microcontroller		Development Tools		
Product name	Package (Lead pitch, body size) Package code	Fujitsu Microelectronics ICE		
		Adapter, header	Main unit, other	Evaluation Device - Package - DSU type
MB91F211B	LQFP-100P (0.5mm, 14 × 14mm) FPT-100P-M20	- Adapter board: MB2198-140 - Header: MB2198-142 Note: Tokyo Eletech IC socket is required separately (1-set is bundled: NQPACK100SD-ND, HQPACK100SD) .		- MB91V210 - PGA420 - DSU4
MB91213A MB91F213A	LQFP-144P (0.5mm, 20 × 20mm) FPT-144P-M08	- Adapter board: MB2198-140 - Header: MB2198-141 Note: Tokyo Eletech IC socket is required separately (1-set is bundled: NQPACK144SD-ND, HQPACK144SD)		- MB91V210 - PGA420 - DSU4
MB91F223 MB91F223S	LQFP-144P (0.5mm, 20 × 20mm) FPT-144P-M08	- Adapter board: MB2198-130 - Header: MB2198-132 Note: Tokyo Eletech IC socket is required separately (1-set is bundled: NQPACK144SD-ND, HQPACK144SD)		- MB91V220 - PGA401 - DSU4
MB91233L MB91F233 MB91F233L	LQFP-120P (0.4mm, 14 × 14mm) FPT-120P-M05	- Adapter board: MB2198-130 - Header: MB2198-121 Note: Tokyo Eletech IC socket is required separately (1-set is bundled: NQPACK120SE, HQPACK120SE) .		- MB91V230 - PGA401 - DSU4
MB91248 *1 MB91248S *1 MB91F248 MB91F248S	LQFP-144P (0.5mm, 20 × 20mm) FPT-144P-M08	- Adapter board: MB2198-130 - Header: MB2198-123 Note: Tokyo Eletech IC socket is required separately (1-set is bundled: NQPACK144SD-ND, HQPACK144SD)	- Main unit: MB2198-01	- MB91V245A - PGA401 - DSU4
MB91263B MB91264B MB91F264B	LQFP-100P (0.5mm, 14 × 14mm) FPT-100P-M05	- Adapter board: MB2198-130 - Header: MB2198-126 *3 Note: Tokyo Eletech IC socket is required separately (1-set is bundled: NQPACK100SD-ND, HQPACK100SD) .	- Evaluation device: separately available - Debugger software: SOFTUNE - RS232C cable: Commercial product (9pin-9pin cross) - USB1.1 cable: Commercial product - LAN cable: Commercial product	- MB91V260B - PGA401 - DSU4
	QFP-100P (0.65mm, 14 × 20mm) FPT-100P-M06	- Adapter board: MB2198-130 - Header: MB2198-122 Note: Tokyo Eletech IC socket is required separately (1-set is bundled: NQPACK100RB179-A, HQPACK100RB179) .		
MB91267A MB91267NA MB91F267A MB91F267NA	LQFP-64 (0.65mm, 12 × 12mm) FPT-64P-M09	- Adapter board: MB2198-130 - Header: MB2198-128 Note: Tokyo Eletech IC socket is required separately (1-set is bundled: NQPACK064SB, HQPACK064SB140) .		- MB91V265A - PGA401 - DSU4
MB91F273 MB91F273S MB91F278 MB91F278S	LQFP-100 (0.5mm, 14 × 14mm) FPT-100P-M05	- Adapter board: MB2198-130 - Header: MB2198-129 Note: Tokyo Eletech IC socket is required separately (1-set is bundled: NQPACK100SD-ND, HQPACK100SD) .		- MB91V280 - PGA401 - DSU4
MB91302A	LQFP-144 (0.4mm, 16 × 16mm) FPT-144P-M12	- Adapter board: MB2198-100 - Header: MB2198-101 *3 Note: Tokyo Eletech IC socket is required separately (1-set is bundled: NQPACK144SE, HQPACK144SE) . - RAM board (Option) : MB2198-90	- Main unit: MB2198-01 - DSU cable: MB2198-10 - Evaluation device: separately available - RS232C cable or USB cable or LAN cable - Debugger software: SOFTUNE	- MB91V301A - PGA179 - DSU4

Support Hardware for FR Family

Development Tools		Equipment for Program to Flash				Target Microcontroller
Evaluation board		Microcontroller Subject to Program	Parallel programmer		Serial programmer	
Fujitsu Microelectronics	Sunhayato Corp.	Product name (Package)	Maker name	Programming adapter	Maker name Product name	Product name
Not supported	Not supported	MB91F211B FPT-100P-M20	Flash Support Group *5	Under development	—	MB91F211B
Not supported	Not supported	MB91F213A FPT-144P-M08	Flash Support Group *5	TEF110-91F213	—	MB91213A MB91F213A
Not supported	Not supported	MB91F223 MB91F223S FPT-144P-M08	Flash Support Group *5	TEF110-248F42AP	—	MB91F223 MB91F223S
- MB91920EB	Not supported	MB91F233 MB91F233L FPT-120P-M05	Minato Electronics *4	MF13-1330 (for MODEL1893/ 1931)	Yokogawa Digital Computer NETIMPRESS *6	MB91233L MB91F233 MB91F233L
			Flash Support Group *5	TEF110-233F20AP		
Not supported	Not supported	MB91F248 MB91F248S FPT-144P-M08	Flash Support Group *5	TEF110-248F42AP	Yokogawa Digital Computer NETIMPRESS *6	MB91248 *1 MB91248S *1 MB91F248 MB91F248S
- MB91921EB	- Main unit: BBF- 2001-MB01 - Daughter unit: BBF-2001- FR100CAN2-NB - Main + Daughter unit: BBF-2001- FR100CAN2-NS	MB91F264B FPT-100P-M05	Minato Electronics *4	MF13-1605 (for MODEL1893/ 1931)	Flash Support Group *5 AF9101	MB91263B MB91264B MB91F264B
			Flash Support Group *5	TEF110-264F34AP	Yokogawa Digital Computer NETIMPRESS *6	
		MB91F264B FPT-100P-M06	Minato Electronics *4	MF13-1427 (for MODEL1893/ 1931)	Flash Support Group *5 AF9101	
			Flash Support Group *5	TEF110-264F21AP	Yokogawa Digital Computer NETIMPRESS *6	
Not supported	Not supported	MB91F267A MB91F267NA FPT-64P-M09	Flash Support Group *5	TEF110-267F43AP	Yokogawa Digital Computer NETIMPRESS *6	MB91267A MB91267NA MB91F267A MB91F267NA
Not supported	- Main unit: BBF- 2004 - Daughter unit: BBF-2004- FR100SCL-NB - Main + Daughter unit: BBF-2004- FR100SCL-NS	MB91F272 FPT-100P-M05	Flash Support Group *5	TEF110-272F39AP	—	MB91F273 MB91F273S MB91F278 MB91F278S
- Main board: MB91906EB - Daughter board: MB91914EB	Not supported	—	—	—	—	MB91302A

Support Hardware
for FR Family

Support Hardware for FR Family

Target Microcontroller		Development Tools		
Product name	Package (Lead pitch, body size) Package code	Fujitsu Microelectronics ICE		
		Adapter, header	Main unit, other	Evaluation Device - Package - DSU type
MB91305	LQFP-176 (0.5 mm, 24 × 24 mm) FPT-176P-M07	-		- MB91305 - LQFP-176 - DSU4
MB91306R MB91307B MB91307R	LQFP-120 (0.5 mm, 16 × 16 mm) FPT-120P-M21	- Adapter board: MB2197-170A - Header: MB2197-172 *3 Note: Tokyo Eletech IC socket is required separately (1-set is bundled: NQPACK120SD, HQPACK120SD. - RAM board (Option) : MB2197-91		- MB91V307R - PGA135 - DSU3
MB91F312A	LQFP-144 (0.5 mm, 20 × 20 mm) FPT-144P-M08	-		- MB91FV310A - LQFP-144 - DSU4
MB91F313	LQFP-176 (0.5 mm, 24 × 24 mm) FPT-176P-M07	-	- Main unit: MB2198-01 - DSU cable: MB2198-10 - Evaluation device: separately available - Debugger software: SOFTUNE	- MB91F313 - LQFP-176 - DSU4
MB91F314A	LQFP-120 (0.5 mm, 16 × 16 mm) FPT-120P-M21	-	- RS232C cable: Commercial product (9pin-9pin cross) - USB1.1 cable: Commercial product - LAN cable: Commercial product	- MB91F314A - LQFP-120 - DSU4
MB91316A MB91F318A MB91F318B	LQFP-176 (0.5 mm, 24 × 24 mm) FPT-176P-M07	-		- MB91FV319A - LQFP-176 - DSU4
MB91F318R MB91F318S	LQFP-176 (0.5 mm, 24 × 24 mm) FPT-176P-M07	-		- MB91FV319R - LQFP-176 - DSU4
MB91F345B MB91F346B *1	LQFP-100 (0.5 mm, 14 × 14 mm) FPT-100P-M05	-		- MB91F345B - MB91F346B - LQFP-100 - DSU4
MB91351A MB91352A MB91353A MB91F353A	LQFP-120 (0.5mm, 16 × 16mm) FPT-120P-M21	- Adapter board: MB2198-110 - Header: MB2198-112 *3 Note: Tokyo Eletech IC socket is required separately (1-set is bundled: NQPACK120SD, HQPACK120SD.	- Main unit: MB2198-01 - Evaluation device: separately available - Debugger software: SOFTUNE	- MB91V350A - BGA420 - DSU4
MB91354A MB91355A MB91F355A MB91F356B	LQFP-176 (0.5mm, 24 × 24mm) FPT-176P-M02	- Adapter board: MB2198-110 - Header: MB2198-111 *3 Note: Tokyo Eletech IC socket is required separately (1-set is bundled: NQPACK176SD, HQPACK176SD.	- RS232C cable: Commercial product (9pin-9pin cross) - USB1.1 cable: Commercial product - LAN cable: Commercial product	- MB91V350A - BGA420 - DSU4
MB91F362GB	QFP-208 (0.5 mm, 28 × 28 mm) FPT-208P-M04	- Adapter board: MB2197-120 - Header: MB2197-127 *3 Note: Tokyo Eletech IC socket is required separately (1-set is bundled.: NQPACK208SD, HQPACK208SD) .	- Main unit: MB2198-01 - DSU cable: MB2198-10 - Evaluation device: separately available - Debugger software: SOFTUNE	- MB91FV360GA - PGA401 - DSU3
MB91F364G	LQFP-120 (0.5mm, 16 × 16mm) FPT-120P-M21		- RS232C cable: Commercial product (9pin-9pin cross) - USB1.1 cable: Commercial product - LAN cable: Commercial product	
MB91F365GB	LQFP-120 (0.5mm, 16 × 16mm) FPT-120P-M21	- Adapter board: MB2197-120 - Header: MB919360-120L or MB919360-120H		- MB91FV360GA - PGA401 - DSU3
MB91366GA MB91F366GB	LQFP-120 (0.5mm, 16 × 16mm) FPT-120P-M21			

Support Hardware for FR Family

Development Tools		Equipment for Program to Flash				Target Microcontroller
Evaluation board		Microcontroller Subject to Program	Parallel programmer		Serial programmer	
Fujitsu Microelectronics	Sunhayato Corp.	Product name (Package)	Maker name	Programming adapter	Maker name Product name	Product name
- MB91925EB	-	—	—	—	—	MB91305
- Main board: MB91906EB - Daughter board: MB91915EB	Not supported	—	—	—	—	MB91306R MB91307B MB91307R
- MB91918EB	Not supported	MB91FV310A FPT-144P-M08	Minato Electronics *4	MF00-1526 (for MODEL1893/ 1931)	Not supported	MB91F312A
—	Not supported	MB91F313 FPT-176P-M07	Flash Support Group *5	TRF110-91F313	—	MB91F313
—	Not supported	MB91F314A FPT-120P-M21	Flash Support Group *5	TRF110-91F313	—	MB91F314A
—	Not supported	MB91FV319A FPT-176P-M07	Minato Electronics *4	MF05-1695 (for MODEL1940)	Not supported	MB91316A MB91F318A MB91F318B
—	Not supported	MB91FV319R FPT-176P-M07	Flash Support Group *5	TEF110-91FV319R	Not supported	MB91F318R MB91F318S
Not supported	Not supported	—	—	—	Under planning	MB91F345B MB91F346B *1
- Main board: MB91906EB - Daughter board: MB91922EB	Not supported	MB91F353A FPT-120P-M21	Minato Electronics *4	Under development	Yokogawa Digital Computer NETIMPRESS *6	MB91351A MB91352A MB91353A MB91F353A
			Flash Support Group *5	TEF110-353F18AP		
- Main board: MB91906EB - Daughter board: MB91916EB	Not supported	MB91F355A FPT-176P-M02	Minato Electronics *4	MF13-1361 (for MODEL1893/ 1931)	Yokogawa Digital Computer NETIMPRESS *6	MB91354A MB91355A MB91F355A MB91F356B
			Flash Support Group *5	TEF110-355F19AP		
- Main board: MB91906EB - Daughter board: MB91913EB *: Simple substance use is possible (Option: MB91F362GA , Connection use of ICE is possible (NQPACk socket is used).	Not supported	MB91F362GA FPT-208P-M04	Minato Electronics *4	MF00-892 (for MODEL1893/ 1931) MF05-892 (for MODEL1940)	Yokogawa Digital Computer NETIMPRESS *6	MB91F362GB
Not supported	Not supported	MB91F364G FPT-120P-M21	Minato Electronics *4	MF00-964 (for MODEL1893/ 1931)	Not supported	MB91F364G
Not supported	Not supported	MB91F365GB FPT-120P-M21	Minato Electronics *4	MF00-964 (for MODEL1893/ 1931)	Not supported	MB91F365GB
Not supported	Not supported	MB91F366GB FPT-120P-M21	Minato Electronics *4	MF00-964 (for MODEL1893/ 1931)	Not supported	MB91366GA MB91F366GB

Support Hardware for FR Family

Target Microcontroller		Development Tools		
Product name	Package (Lead pitch, body size) Package code	Fujitsu Microelectronics ICE		
		Adapter, header	Main unit, other	Evaluation Device - Package - DSU type
MB91F367GB	LQFP-120 (0.5mm, 16 × 16mm) FPT-120P-M21	- Adapter board: MB2197-120 - Header: MB919360-120L or MB919360-120H		- MB91FV360GA - PGA401 - DSU3
MB91F368GB	LQFP-120 (0.5mm, 16 × 16mm) FPT-120P-M21			
MB91F376G	LQFP-120 (0.5mm, 16 × 16mm) FPT-120P-M21			
MB91F369GA	QFP-160 (0.65mm, 28 × 28mm) FPT-160P-M15	- Adapter board: MB2197-120 - Header: MB919360-160		- MB91FV360GA - PGA401 - DSU3
MB91461	LQFP-176P (0.5 mm, 24 × 24 mm) FPT-176P-M07	—		- MB91461 - LQFP176 - DSU4
MB91F463N	LQFP-64P (0.65 mm, 12 × 12 mm) FPT-64P-M23	- Adapter board: MB2198-300A - Header: MB2198-304A-E		- MB91V460 - BGA660 - DSU4
MB91F464A	LQFP-100P (0.5 mm, 14 × 14 mm) FPT-100P-M20	- Adapter board: MB2198-600A5 - Adapter board: MB2198-600A4 (GHS) - Header: MB2198-606 (non level shifter)		- MB91V460 - BGA660 - DSU4
MB91F465B	LQFP-144P (0.5 mm, 20 × 20 mm) FPT-144P-M08	- Adapter board: MB2198-600A5 - Adapter board: MB2198-600A4 (GHS) - Header: MB2198-604B (non level shifter) - Header: MB2198-634B (level shifter) - Header: MB2198-664 (single chip)	- Main unit: MB2198-01	- MB91V460 - BGA660 - DSU4
MB91F465K	LQFP-120P (0.5 mm, 16 × 16 mm) FPT-120P-M21	- Adapter board: MB2198-600A5 - Adapter board: MB2198-600A4 (GHS) - Header: MB2198-609 (non level shifter)	- DSU cable: MB2198-10	- MB91V460 - BGA660 - DSU4
MB91F465X	LQFP-100P (0.5 mm, 14 × 14 mm) FPT-100P-M20	- Adapter board: MB2198-600A5 - Adapter board: MB2198-600A4 (GHS) - Header: MB2198-602 (non level shifter) - FlexRay expansion board: MB2198-603	- Evaluation device: separately available - Debugger software: SOFTUNE - RS232C cable: Commercial product(9pin-9pin cross)	- MB91V460 - BGA660 - DSU4
MB91F467R	LQFP-176P (0.5 mm, 24 × 24 mm) FPT-176P-M07	- Adapter board: MB2198-300A - Header: MB2198-305 (level shifter)	- USB1.1 cable: Commercial product - LAN cable: Commercial product	- MB91V460 - BGA660 - DSU4
	LQFP-176P (0.5 mm, 24 × 24 mm) FPT-176P-M07	- Adapter board: MB2198-600 - Header: MB2198-601 (non level shifter)		- MB91V460 - BGA660 - DSU4
MB91F467B	LQFP-144P (0.5 mm, 20 × 20 mm) FPT-144P-M08	- Adapter board: MB2198-600A5 - Adapter board: MB2198-600A4 (GHS) - Header: MB2198-604B (non level shifter) - Header: MB2198-634B (level shifter) - Header: MB2198-664 (single chip)		- MB91V460 - BGA660 - DSU4
MB91F467C	QFP-144P (0.5 mm, 20 × 20 mm) FPT-144P-M08	- Adapter board: MB2198-600A5 - Adapter board: MB2198-600A4 (GHS) - Header: MB2198-607 (non level shifter)		- MB91V460 - BGA660 - DSU4
MB91F467D	LQFP-208P (0.5 mm, 28 × 28 mm) FPT-208P-M07	- Adapter board: MB2198-600A5 - Adapter board: MB2198-600A4 (GHS) - Header: MB2198-605B (non level shifter) - Header: MB2198-635B (level shifter)		- MB91V460 - BGA660 - DSU4
MB91F469G	BGA-320P	- Adapter board: MB2198-600A5 - Adapter board: MB2198-600A4 (GHS) - Header: MB2198-608 (non level shifter) - Header: MB2198-638 (level shifter)		- MB91V460 - BGA660 - DSU4
MB91F475 MB91F478 MB91F479	LQFP-144P (0.4 mm, 16 × 16 mm) FPT-144P-M12	- Adapter board: MB2198-160 - Header: MB2198-161 - Pseudo power-on debug adapter: MB2198-169		- MB91FV470 - BGA224 - DSU4
	PFBGA-144P (0.8 mm, 12 × 12 mm) BGA-144P-M06	—		- MB91FV470 - BGA224 - DSU4
MB91F482 MB91F487	LQFP-100P (0.5 mm, 14 × 14 mm) FPT-100P-M20	- Adapter board: MB2198-160 - Header: MB2198-162 - Pseudo power-on debug adapter: MB2198-169		- MB91FV470 - BGA224 - DSU4

*1: Under development

*2: A Yamaichi Electronics IC socket is required for connection of an adapter.

Contact details: TEL: (81-3)3778-6104, FAX: (81-3)3778-6171, http://www.yamaichi.co.jp/index_e_shtml

*3: A Tokyo Eletech IC socket is required for connection of an adapter (side of user's board)

Contact details: TEL: (81-3)5295-1661, FAX: (81-3)5295-1663, http://www.tetc.co.jp/e_tet.htm

*4: MINATO ELECTRONICS INC.

Contact details: TEL: (81)45-591-5611, FAX: (81-45)592-2854, http://www.minato.co.jp/index_e.asp

*5: Flash Support Group, Inc.

Contact details: TEL: (81)53-428-8383, <http://www.j-fsg.co.jp/e/top.html>

*6: Yokogawa Digital Computer Corporation

Contact details: TEL: (81)42-333-6224, FAX: (81)42-352-6107, <http://www.yokogawa-digital.com/emb/en/index.html>

Support Hardware for FR Family

Development Tools		Equipment for Program to Flash				Target Microcontroller
Evaluation board		Microcontroller Subject to Program	Parallel programmer		Serial programmer	
Fujitsu Microelectronics	Sunhayato Corp.	Product name (Package)	Maker name	Programming adapter	Maker name Product name	Product name
Not supported	Not supported	MB91F367GB FPT-120P-M21	Minato Electronics *4	MF00-964 (for MODEL1893/ 1931)	Not supported	MB91F367GB
Not supported	Not supported	MB91F368GB FPT-120P-M21	Minato Electronics *4	MF00-964 (for MODEL1893/ 1931)	Not supported	MB91F368GB
Not supported	Not supported	MB91F376G FPT-120P-M21	Minato Electronics *4	MF00-964 (for MODEL1893/ 1931)	Not supported	MB91F376G
Under development	Not supported	MB91F369GA FPT-160P-M15	Minato Electronics *4	MF00-1272 (for MODEL1893/ 1931) MF05-1272 (for MODEL1940)	Yokogawa Digital Computer NETIMPRESS *6	MB91F369GA
Not supported	Not supported	—	—	—	—	MB91461
Not supported	Not supported	—	—	—	—	MB91F463N
Not supported	Not supported	—	—	—	—	MB91F464A
Not supported	Not supported	—	—	—	—	MB91F465B
Not supported	Not supported	—	—	—	—	MB91F465K
Not supported	Not supported	—	—	—	—	MB91F465X
Not supported	Not supported	—	—	—	—	MB91F467R
Not supported	Not supported	—	—	—	—	MB91F467B
Not supported	Not supported	—	—	—	—	MB91F467C
Not supported	Not supported	—	—	—	—	MB91F467D
Not supported	Not supported	—	—	—	—	MB91F469G
Not supported	Not supported	—	—	—	Yokogawa Digital Computer NETIMPRESS *1, *6	MB91F475 MB91F478 MB91F479
Not supported	Not supported	—	—	—	Yokogawa Digital Computer NETIMPRESS *1, *6	
Not supported	Not supported	—	—	—	Yokogawa Digital Computer NETIMPRESS *1, *6	MB91F482 MB91F487

Package Line-up

Package Line-up

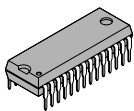
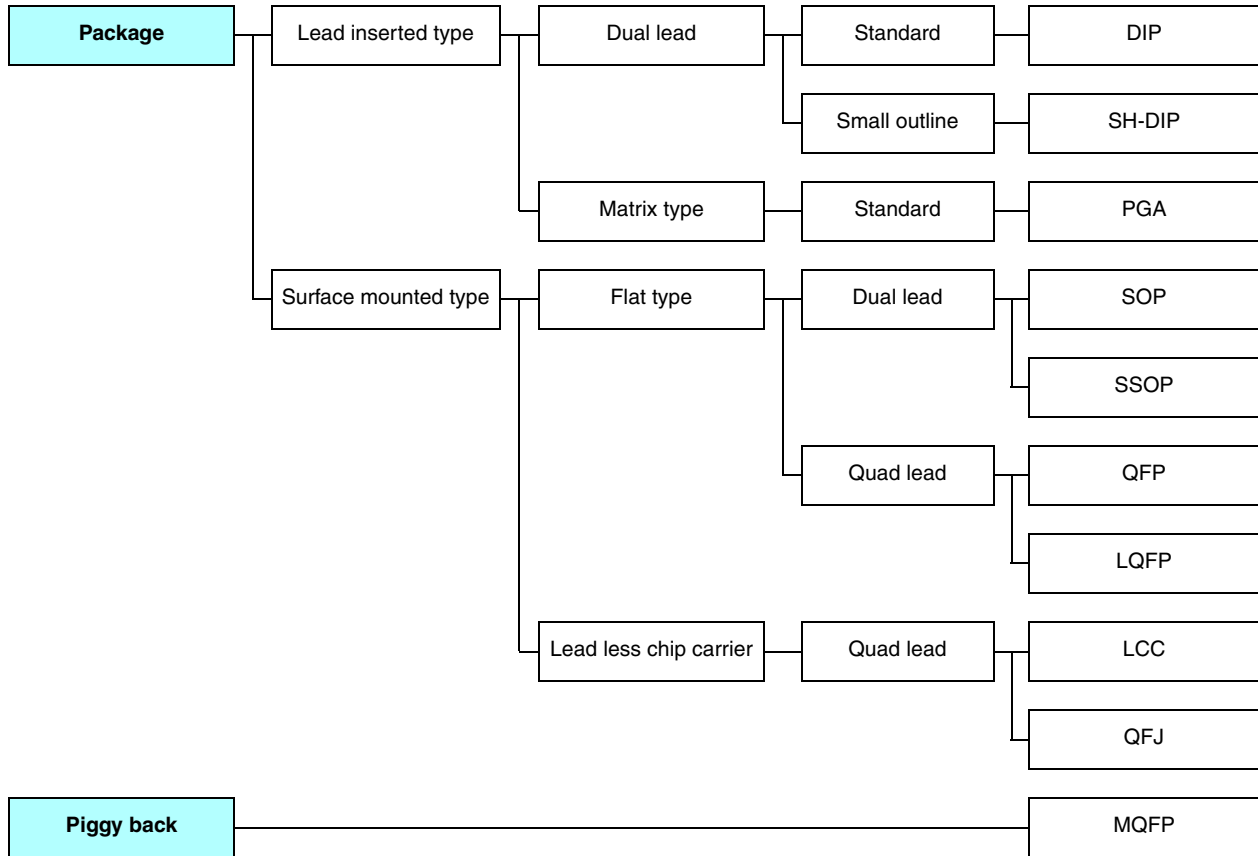

DIP-28P

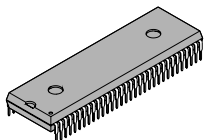

SH-DIP-64P

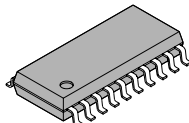

SOP-20P

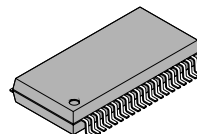

SSOP-40P

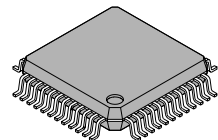

QFP-48P

Package Line-up

Name of package	Description	Lead pitch (mm)
DIP	Dual In-line Package	2.54
SH-DIP *	Shrink Dual In-line Package	1.778
PGA	Pin Grid Array Package	1.27/2.54
SOP	Small Outline Package (straight lead) Small Outline L-Leaded Package (gull wing lead)	1.27
SSOP	Shrink Small Outline L-Leaded Package	0.65/0.80/1.00
QFP	Quad Flat Package (straight lead), Quad Flat L-Leaded Package (gull wing lead)	0.40/0.50/ 0.65/0.80/1.00
LQFP *	Low-Profile Quad Flat L-Leaded Package	0.40/0.50/0.65/0.80
LCC	Leadless Chip Carrier	1.016
QFJ	Quad Flat J-Leaded Package	1.27
MQFP	Quad Flat Type Module	0.50/0.65/0.80/1.00

*: Package name by Fujitsu Microelectronics.

Note: Plastic surface mount packages have some limitations regarding mounting conditions. Please check before using

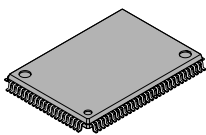

LQFP-100P

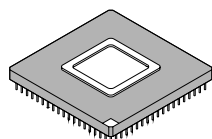

PGA-256C

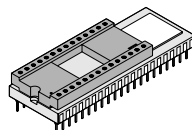

MDIP-42C

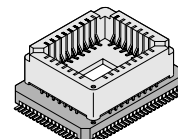

MQFP-80C

Index

Part number	Page	Document code	Part number	Page	Document code
MB89051	32	DS07-12551-2E	MB89825	18	DS07-12513-6E
MB89121	8	DS07-12509-7E	MB89865	30	DS07-12504-5E
MB89123A	8	DS07-12509-7E	MB89867	30	DS07-12504-5E
MB89125A	8	DS07-12509-7E	MB89898	28	DS07-12524-4E
MB89131	8	DS07-12510-10E	MB89899	28	DS07-12524-4E
MB89133A	8	DS07-12510-10E	MB89923	22	DS07-12526-1E
MB89135A	8	DS07-12510-10E	MB89925	22	DS07-12526-1E
MB89143A	28	DS07-12528-3E	MB89935B	10	DS07-12541-6E
MB89144A	28	DS07-12528-3E	MB89943	16	DS07-12536-5E
MB89145	28	DS07-12522-3E	MB89945	16	DS07-12536-5E
MB89146	28	DS07-12522-3E	MB89983	16	-
MB89161	20	DS07-12405-3E	MB89F051	32	DS07-12551-2E
MB89161A	20	DS07-12405-3E	MB89F202	10	DS07-12561-1E
MB89163	20	DS07-12405-3E	MB89F202RA	10	-
MB89163A	20	DS07-12405-3E	MB89F202RAY	10	-
MB89165	20	DS07-12405-3E	MB89F202Y	10	-
MB89165A	20	DS07-12405-3E	MB89F499	26	DS07-12560-1E
MB89191	6	DS07-12512-8E	MB89F538	12	DS07-12547-5E
MB89191A	6	DS07-12512-8E	MB89F538L	12	DS07-12548-4E
MB89191AH	6	DS07-12512-8E	MB89P131	8	DS07-12510-10E
MB89193	6	DS07-12512-8E	MB89P133A	8	DS07-12510-10E
MB89193A	6	DS07-12512-8E	MB89P135A	8	DS07-12510-10E
MB89193AH	6	DS07-12512-8E	MB89P147	28	DS07-12522-3E
MB89195	6	DS07-12512-8E	MB89P165	20	DS07-12405-3E
MB89195A	6	DS07-12512-8E	MB89P195	6	DS07-12512-8E
MB89202	10	DS07-12561-1E	MB89P195A	6	DS07-12512-8E
MB89202Y	10	-	MB89P475	12	DS07-12552-1E
MB89475	12	DS07-12552-1E	MB89P485	18	DS07-12559-1E
MB89485	18	DS07-12559-1E	MB89P485L	18	DS07-12559-1E
MB89485L	18	DS07-12559-1E	MB89P538	12	-
MB89498	26	DS07-12560-1E	MB89P558A	24	DS07-12550-1E
MB89535A	12	DS07-12547-5E	MB89P568	22	DS07-12555-1E
MB89537A	12	DS07-12547-5E	MB89P585B	32	DS07-12543-4E
MB89537AC	12	DS07-12547-5E	MB89P585BW	32	DS07-12543-4E
MB89538A	12	DS07-12547-5E	MB89P589B	32	DS07-12543-4E
MB89538AC	12	DS07-12547-5E	MB89P637	14	-
MB89557A	24	DS07-12550-1E	MB89P677A	14	-
MB89558A	24	DS07-12550-1E	MB89P808	24	DS07-12549-1E
MB89567A	22	DS07-12555-1E	MB89P825	18	DS07-12513-6E
MB89567AC	22	DS07-12555-1E	MB89P867	30	DS07-12504-5E
MB89583B	32	DS07-12543-4E	MB89P899	28	DS07-12524-4E
MB89583BW	32	DS07-12543-4E	MB89P928	22	DS07-12526-1E
MB89585B	32	DS07-12543-4E	MB89P935B	10	DS07-12541-6E
MB89585BW	32	DS07-12543-4E	MB89P945	16	DS07-12536-5E
MB89589B	32	DS07-12543-4E	MB89P985	16	-
MB89635R	14	DS07-12531-2E	MB89PV130A	8	-
MB89636R	14	DS07-12531-2E	MB89PV140	28	-
MB89637R	14	DS07-12531-2E	MB89PV160	20	-
MB89673AR	14	DS07-12537-1E	MB89PV190	6	-
MB89675AR	14	DS07-12537-1E	MB89PV190A	6	-
MB89677AR	14	DS07-12537-1E	MB89PV470	12	-
MB89803	24	DS07-12549-1E	MB89PV480	18	DS07-12559-1E
MB89805	24	DS07-12549-1E	MB89PV490	26	-
MB89821	18	DS07-12513-6E	MB89PV530	12	DS07-12548-4E
MB89823R	18	DS07-12513-6E	MB89PV550A	24	-

Part number	Page	Document code	Part number	Page	Document code
MB89PV560	22	-	MB90362E	102	DS07-13746-2E
MB89PV630	14	-	MB90362ES	102	DS07-13746-2E
MB89PV670A	14	-	MB90362TE	102	DS07-13746-2E
MB89PV800	24	-	MB90362TES	102	DS07-13746-2E
MB89PV820	18	-	MB90367E	102	DS07-13746-2E
MB89PV890	28	-	MB90367ES	102	DS07-13746-2E
MB89PV920	22	-	MB90367TE	102	DS07-13746-2E
MB89PV930A	10	-	MB90367TES	102	DS07-13746-2E
MB89PV940	16	-	MB90372	130	DS07-13729-1E
MB89PV980	16	-	MB90387	104	DS07-13717-3E
MB89V201	10	-	MB90387S	104	DS07-13717-3E
MB89W165	20	DS07-12405-3E	MB90394HA	124	DS07-13723-6E
MB89W867	30	DS07-12504-5E	MB90423GA	110	DS07-13711-4E
MB90333A	134	DS07-13734-3E	MB90423GC	110	DS07-13711-4E
MB90337	134	DS07-13735-2E	MB90427GA	112	DS07-13711-4E
○ MB90341CE	118	DS07-13747-2E	MB90427GC	112	DS07-13711-4E
○ MB90341CES	118	DS07-13747-2E	MB90428GA	112	DS07-13711-4E
○ MB90341E	118	DS07-13747-2E	MB90428GC	112	DS07-13711-4E
○ MB90341ES	118	DS07-13747-2E	MB90437L	94	DS07-13727-1E
MB90342CE	118	DS07-13747-2E	MB90437LS	94	DS07-13727-1E
MB90342CES	118	DS07-13747-2E	MB90438L	94	DS07-13727-1E
MB90342E	118	DS07-13747-2E	MB90438LS	94	DS07-13727-1E
MB90342ES	118	DS07-13747-2E	MB90439	94	DS07-13727-1E
MB90346CE	116	DS07-13747-2E	MB90439S	94	DS07-13727-1E
MB90346CES	116	DS07-13747-2E	○ MB90443G	112	DS07-13716-2E
MB90346E	116	DS07-13747-2E	MB90455	84	DS07-13728-3E
MB90346ES	116	DS07-13747-2E	MB90455S	84	DS07-13728-3E
MB90347CE	116	DS07-13747-2E	MB90456	84	DS07-13728-3E
MB90347CES	116	DS07-13747-2E	MB90456S	84	DS07-13728-3E
MB90347E	116	DS07-13747-2E	MB90457	84	DS07-13728-3E
MB90347ES	116	DS07-13747-2E	MB90457S	84	DS07-13728-3E
○ MB90348CE	116	DS07-13747-2E	MB90462	86	DS07-13714-1E
○ MB90348CES	116	DS07-13747-2E	MB90467	86	DS07-13714-1E
○ MB90348E	116	DS07-13747-2E	MB90483C	96	DS07-13722-9E
○ MB90348ES	116	DS07-13747-2E	MB90487B	96	DS07-13722-9E
MB90349CE	116	DS07-13747-2E	MB90488B	96	DS07-13722-9E
MB90349CES	116	DS07-13747-2E	MB90497G	110	DS07-13713-3E
MB90349E	116	DS07-13747-2E	MB90522B	128	DS07-13707-3E
MB90349ES	116	DS07-13747-2E	MB90523B	128	DS07-13707-3E
MB90351E	106	DS07-13744-3E	MB90543G	114	DS07-13703-5E
MB90351ES	106	DS07-13744-3E	MB90543GS	114	DS07-13703-5E
MB90351TE	106	DS07-13744-3E	MB90547G	120	DS07-13703-5E
MB90351TES	106	DS07-13744-3E	MB90547GS	120	DS07-13703-5E
MB90352E	106	DS07-13744-3E	MB90548G	120	DS07-13703-5E
MB90352ES	106	DS07-13744-3E	MB90548GS	120	DS07-13703-5E
MB90352TE	106	DS07-13744-3E	MB90549G	120	DS07-13703-5E
MB90352TES	106	DS07-13744-3E	MB90549GS	120	DS07-13703-5E
MB90356E	108	DS07-13744-3E	MB90552A	90	DS07-13706-4E
MB90356ES	108	DS07-13744-3E	MB90552B	90	DS07-13706-4E
MB90356TE	108	DS07-13744-3E	MB90553A	90	DS07-13706-4E
MB90356TES	108	DS07-13744-3E	MB90553B	90	DS07-13706-4E
MB90357E	108	DS07-13744-3E	MB90561A	86	DS07-13715-3E
MB90357ES	108	DS07-13744-3E	MB90562A	86	DS07-13715-3E
MB90357TE	108	DS07-13744-3E	MB90567	88	DS07-13715-3E
MB90357TES	108	DS07-13744-3E	MB90568	88	DS07-13715-3E

○: Under planning

Index

Part number	Page	Document code
MB90573	100	DS07-13701-8E
MB90574C	100	DS07-13701-8E
MB90583C	92	DS07-13710-4E
MB90583CA	92	DS07-13710-4E
MB90587C	92	DS07-13710-4E
MB90587CA	92	DS07-13710-4E
MB90591G	124	DS07-13704-5E
MB90594G	124	DS07-13704-5E
MB90598G	114	DS07-13705-6E
MB90803	128	DS07-13733-2E
○ MB90804	128	-
MB90822	90	DS07-13738-2E
MB90823	90	DS07-13738-2E
MB90867E	92	DS07-13748-2E
MB90867ES	92	DS07-13748-2E
○ MB90882	98	DS07-13743-2E
○ MB90883	98	DS07-13743-2E
○ MB90884	98	DS07-13743-2E
MB90947A	122	DS07-13741-2E
MB90982	88	DS07-13742-1E
MB90F334A	134	DS07-13734-3E
MB90F337	134	DS07-13735-2E
MB90F342CE	118	DS07-13747-2E
MB90F342CES	118	DS07-13747-2E
MB90F342E	118	DS07-13747-2E
MB90F342ES	118	DS07-13747-2E
○ MB90F343CE	118	DS07-13747-2E
○ MB90F343CES	118	DS07-13747-2E
○ MB90F343E	118	DS07-13747-2E
○ MB90F343ES	118	DS07-13747-2E
MB90F345CE	118	DS07-13747-2E
MB90F345CES	118	DS07-13747-2E
MB90F345E	118	DS07-13747-2E
MB90F345ES	118	DS07-13747-2E
MB90F346CE	116	DS07-13747-2E
MB90F346CES	116	DS07-13747-2E
MB90F346E	116	DS07-13747-2E
MB90F346ES	116	DS07-13747-2E
MB90F347CE	116	DS07-13747-2E
MB90F347CES	116	DS07-13747-2E
MB90F347E	116	DS07-13747-2E
MB90F347ES	116	DS07-13747-2E
MB90F349CE	116	DS07-13747-2E
MB90F349CES	116	DS07-13747-2E
MB90F349E	116	DS07-13747-2E
MB90F349ES	116	DS07-13747-2E
MB90F351E	106	DS07-13744-3E
MB90F351ES	106	DS07-13744-3E
MB90F351TE	106	DS07-13744-3E
MB90F351TES	106	DS07-13744-3E
MB90F352E	106	DS07-13744-3E
MB90F352ES	106	DS07-13744-3E
MB90F352TE	106	DS07-13744-3E
MB90F352TES	106	DS07-13744-3E
MB90F356E	108	DS07-13744-3E

Part number	Page	Document code
MB90F356ES	108	DS07-13744-3E
MB90F356TE	108	DS07-13744-3E
MB90F356TES	108	DS07-13744-3E
MB90F357E	108	DS07-13744-3E
MB90F357ES	108	DS07-13744-3E
MB90F357TE	108	DS07-13744-3E
MB90F357TES	108	DS07-13744-3E
MB90F362E	102	DS07-13746-2E
MB90F362ES	102	DS07-13746-2E
MB90F362TE	102	DS07-13746-2E
MB90F362TES	102	DS07-13746-2E
MB90F367E	102	DS07-13746-2E
MB90F367ES	102	DS07-13746-2E
MB90F367TE	102	DS07-13746-2E
MB90F367TES	102	DS07-13746-2E
MB90F372	130	DS07-13729-1E
MB90F378	100	DS07-13740-1E
MB90F387	104	DS07-13717-3E
MB90F387S	104	DS07-13717-3E
MB90F394HA	124	DS07-13723-6E
MB90F423GA	110	DS07-13711-4E
MB90F423GC	110	DS07-13711-4E
MB90F428GA	112	DS07-13711-4E
MB90F428GC	112	DS07-13711-4E
MB90F438L	94	DS07-13727-1E
MB90F438LS	94	DS07-13727-1E
MB90F439	94	DS07-13727-1E
MB90F439S	94	DS07-13727-1E
MB90F443G	112	DS07-13716-2E
MB90F455	84	DS07-13728-3E
MB90F455S	84	DS07-13728-3E
MB90F456	84	DS07-13728-3E
MB90F456S	84	DS07-13728-3E
MB90F457	84	DS07-13728-3E
MB90F457S	84	DS07-13728-3E
MB90F462	86	DS07-13714-1E
MB90F481B	96	DS07-13722-9E
MB90F482B	96	DS07-13722-9E
MB90F488B	96	DS07-13722-9E
MB90F489B	96	DS07-13722-9E
MB90F497G	110	DS07-13713-3E
MB90F498G	110	DS07-13713-3E
MB90F523B	128	DS07-13707-3E
MB90F543G	114	DS07-13703-5E
MB90F543GS	114	DS07-13703-5E
MB90F546G	120	DS07-13703-5E
MB90F546GS	120	DS07-13703-5E
MB90F548G	120	DS07-13703-5E
MB90F548GL	120	DS07-13703-5E
MB90F548GLS	120	DS07-13703-5E
MB90F548GS	120	DS07-13703-5E
MB90F549G	120	DS07-13703-5E
MB90F549GS	120	DS07-13703-5E
MB90F553A	90	DS07-13706-4E
MB90F562B	86	DS07-13715-3E

○: Under planning

Part number	Page	Document code	Part number	Page	Document code
MB90F568	88	DS07-13715-3E	MB90V550A	90	-
MB90F574A	100	DS07-13701-8E	MB90V560	86, 88	-
MB90F583C	92	DS07-13710-4E	MB90V570A	100	-
MB90F583CA	92	DS07-13710-4E	MB90V580B	92	-
MB90F584C	92	-	MB90V590G	124	-
MB90F584CA	92	-	MB90V595G	114	DS07-13705-6E
MB90F591G	124	DS07-13704-5E	MB90V800	128	-
MB90F594G	124	DS07-13704-5E	MB90V820	90	DS07-13738-2E
MB90F598G	114	DS07-13705-6E	MB90V880A-101	98	-
MB90F803	128	-	MB90V880A-102	98	-
MB90F804	128	DS07-13733-2E	MB90V920-101	126	-
© MB90F809	128	-	MB90V920-102	126	-
MB90F822A	90	DS07-13738-2E	MB91101A	218	DS07-16301-4E
MB90F823A	90	DS07-13738-2E	MB91107A	218	-
MB90F867E	92	DS07-13748-2E	MB91108	218	DS07-16305-3E
MB90F867ES	92	DS07-13748-2E	MB91121	218	DS07-16303-3E
MB90F882	98	DS07-13743-2E	MB91133	220	DS07-16308-2E
MB90F882S	98	DS07-13743-2E	MB91151A	222	DS07-16312-1E
MB90F883A	98	DS07-13743-2E	MB91154	222	DS07-16306-3E
MB90F883AS	98	DS07-13743-2E	MB91155	222	DS07-16306-3E
MB90F884A	98	DS07-13743-2E	MB91213A	232	-
MB90F884AS	98	DS07-13743-2E	MB91233L	234	DS07-16506-2E
MB90F897	104	DS07-13731-3E	© MB91248	234	DS07-16803-2E
MB90F897S	104	DS07-13731-3E	© MB91248S	234	DS07-16803-2E
MB90F922NA	126	-	MB91263B	236	DS07-16507-2E
MB90F922NAS	126	-	MB91264B	236	DS07-16507-2E
MB90F946A	122	DS07-13741-2E	MB91267A	236	DS07-16702-4E
MB90F947A	122	DS07-13741-2E	MB91267NA	236	DS07-16702-4E
MB90F949A	122	DS07-13741-2E	MB91302A	224	DS07-16502-3E
MB90F962	84	DS07-13749-1E	MB91302A-010	224	-
MB90F962S	84	DS07-13749-1E	MB91302A-020	224	-
MB90F983	88	DS07-13742-1E	MB91305	224	DS07-16703-1E
MB90M407	132	DS07-13718-2E	MB91306R	224	DS07-16314-2E
MB90M408	132	DS07-13718-2E	MB91307B	224	DS07-16309-3E
MB90MF408	132	DS07-13718-2E	MB91307R	224	DS07-16314-2E
MB90MV405	132	-	MB91314A	228	DS07-16802-1E
MB90P553A	90	DS07-13706-4E	MB91316A	228	DS07-16705-1E
MB90T552A	90	DS07-13706-4E	MB91351A	230	DS07-16503-4E
MB90T553A	90	DS07-13706-4E	MB91352A	230	DS07-16503-4E
MB90V330A	134	DS07-13734-3E	MB91353A	230	DS07-16503-4E
MB90V340E-101	84, 92, 102, 106, 116, 118	DS07-13744-3E	MB91354A	230	DS07-16503-4E
MB90V340E-102	84, 92, 102, 106, 116, 118	DS07-13744-3E	MB91355A	230	DS07-16503-4E
MB90V340E-103	102, 108	DS07-13744-3E	MB91366GA	240	-
MB90V340E-104	102, 108	DS07-13744-3E	MB91461	242	DS07-16602-1E
MB90V370	130	-	© MB91482	250	DS07-16901-2E
MB90V378	100	DS07-13740-1E	MB91605	252	-
MB90V390HB	122, 124	DS07-13723-6E	© MB91661	256	-
MB90V420G	110, 112	DS07-13711-4E	MB91F127	220	DS07-16310-1E
MB90V440G	112	-	MB91F128	220	DS07-16310-1E
MB90V460	86	-	MB91F133A	220	DS07-16308-2E
MB90V480B	96	DS07-13722-9E	MB91F155A	222	DS07-16306-3E
MB90V485B	88, 96	DS07-13722-9E	MB91F158	222	DS07-16316-1E
MB90V495G	84, 104, 110	DS07-13713-3E	MB91F211B	232	-
MB90V520A	128	-	MB91F213A	232	-
MB90V540G	94, 114, 120	-	MB91F223	232	DS07-16806-2E

©: Under development

Index

Part number	Page	Document code
MB91F223S	232	DS07-16806-2E
MB91F233	234	-
MB91F233L	234	DS07-16506-2E
MB91F248	234	DS07-16803-2E
MB91F248S	234	DS07-16803-2E
MB91F264B	236	DS07-16507-2E
MB91F267A	236	DS07-16702-4E
MB91F267NA	236	DS07-16702-4E
○ MB91F272	238	-
○ MB91F272S	238	-
MB91F273	238	DS07-16801-2E
MB91F273S	238	DS07-16801-2E
○ MB91F277	238	-
○ MB91F277S	238	-
○ MB91F278	238	DS07-16801-2E
○ MB91F278S	238	DS07-16801-2E
MB91F312A	226	DS07-16505-2E
MB91F313	226	-
MB91F314A	228	-
MB91F318R	228	DS07-16705-1E
MB91F345B	238	DS07-16704-2E
MB91F346B	238	DS07-16704-2E
MB91F353A	230	DS07-16503-4E
MB91F355A	230	DS07-16503-4E
MB91F356B	230	DS07-16503-4E
MB91F362GB	240	DS07-16401-4E
MB91F364G	240	DS07-16401-4E
MB91F365GB	240	DS07-16401-4E
MB91F366GB	240	DS07-16401-4E
MB91F367GB	240	DS07-16401-4E
MB91F368GB	240	DS07-16401-4E
MB91F369GA	240	DS07-16401-4E
MB91F376G	240	DS07-16401-4E
MB91F464AB	244	-
MB91F465BA	246	-
MB91F465KB	244	-
MB91F465XA	248	-
MB91F467BA	246	-
MB91F467DB	248	-
MB91F467R	242	DS07-16603-1E
MB91F475	250	DS07-16901-2E
MB91F478	250	DS07-16901-2E
MB91F479	250	DS07-16901-2E
MB91F482	250	-
MB91F487	250	DS07-16901-2E
MB91F637	254	-
MB91F639	254	-
MB91F647	254	-
MB91F662	256	-
MB95107B	40	DS07-12617-1E
MB95108AM	42	DS07-12614-2E
MB95116B	38	DS07-12615-1E
MB95117M	40	DS07-12611-4E
MB95128MB	46	DS07-12610-3E
○ MB95136MB	36	DS07-12621-1E

Part number	Page	Document code
MB95156M	44	DS07-12613-3E
MB95F104AJ	42	-
MB95F106AJ	42	-
MB95F108AM	42	-
MB95F108B	40	-
◎ MB95F114J	40	-
◎ MB95F116J	40	-
MB95F118B	38	-
MB95F118M	40	-
MB95F124MB	46	DS07-12610-3E
MB95F126MB	46	DS07-12610-3E
MB95F128D	46	DS07-12616-1E
MB95F128MB	46	DS07-12610-3E
MB95F133J	36	-
MB95F134J	36	-
MB95F136MB	36	-
◎ MB95F146	36	-
MB95F156M	44	DS07-12613-3E
MB95F168M	44	DS07-12609-4E
MB95FV100D-101	36, 38, 40, 46	DS07-12616-1E
MB95FV100D-103	36, 40, 42, 44, 46	DS07-12609-4E
◎ MB96F326RSA	136	-
◎ MB96F326RWA	136	-
◎ MB96F326YSA	136	-
◎ MB96F326YWA	136	-
◎ MB96F348HSC	136	-
◎ MB96F348HWC	136	-
MB96F348RSB	136	-
MB96F348RWB	136	-
◎ MB96F348TSC	136	-
◎ MB96F348TWC	136	-
MB96F348YSB	136	-
MB96F348YWB	136	-
◎ MB96F356RSB	138	-
◎ MB96F356RWB	138	-
◎ MB96F356YSB	138	-
◎ MB96F356YWB	138	-
◎ MB96F387RSA	138	-
◎ MB96F387RWA	138	-
◎ MB96F387YSA	138	-
◎ MB96F387YWA	138	-
MB96V300B	136, 138	-

○: Under planning, ◎: Under development

FUJITSU MICROELECTRONICS LIMITED

Shinjuku Dai-Ichi Seimei Bldg. 7-1, Nishishinjuku 2-chome, Shinjuku-ku,
Tokyo 163-0722, Japan Tel: +81-3-5322-3347 Fax: +81-3-5322-3387
<http://jp.fujitsu.com/fml/en/>

For further information please contact:

North and South America

FUJITSU MICROELECTRONICS AMERICA, INC.
1250 E. Arques Avenue, M/S 333
Sunnyvale, CA 94085-5401, U.S.A.
Tel: +1-408-737-5600 Fax: +1-408-737-5999
<http://www.fma.fujitsu.com/>

Europe

FUJITSU MICROELECTRONICS EUROPE GmbH
Pittlerstrasse 47, 63225 Langen,
Germany
Tel: +49-6103-690-0 Fax: +49-6103-690-122
<http://emea.fujitsu.com/microelectronics/>

Korea

FUJITSU MICROELECTRONICS KOREA LTD.
206 KOSMO TOWER, 1002 Daechi-Dong,
Kangnam-Gu, Seoul 135-280
Korea
Tel: +82-2-3484-7100 Fax: +82-2-3484-7111
<http://www.fmk.fujitsu.com/>

Asia Pacific

FUJITSU MICROELECTRONICS ASIA PTE LTD.
151 Lorong Chuan, #05-08 New Tech Park,
Singapore 556741
Tel: +65-6281-0770 Fax: +65-6281-0220
<http://www.fujitsu.com/sg/services/micro/semiconductor/>

FUJITSU MICROELECTRONICS SHANGHAI CO., LTD.
Rm.3102, Bund Center, No.222 Yan An Road(E),
Shanghai 200002, China
Tel: +86-21-6335-1560 Fax: +86-21-6335-1605
<http://cn.fujitsu.com/fmc/>

FUJITSU MICROELECTRONICS PACIFIC ASIA LTD.
10/F., World Commerce Centre, 11 Canton Road
Tsimshatsui, Kowloon
Hong Kong
Tel: +852-2377-0226 Fax: +852-2376-3269
<http://cn.fujitsu.com/fmc/tw>

All Rights Reserved.

The contents of this document are subject to change without notice.

Customers are advised to consult with sales representatives before ordering.

The information, such as descriptions of function and application circuit examples, in this document are presented solely for the purpose of reference to show examples of operations and uses of FUJITSU MICROELECTRONICS device; FUJITSU MICROELECTRONICS does not warrant proper operation of the device with respect to use based on such information. When you develop equipment incorporating the device based on such information, you must assume any responsibility arising out of such use of the information.

FUJITSU MICROELECTRONICS assumes no liability for any damages whatsoever arising out of the use of the information.

Any information in this document, including descriptions of function and schematic diagrams, shall not be construed as license of the use or exercise of any intellectual property right, such as patent right or copyright, or any other right of FUJITSU MICROELECTRONICS or any third party or does FUJITSU MICROELECTRONICS warrant non-infringement of any third-party's intellectual property right or other right by using such information. FUJITSU MICROELECTRONICS assumes no liability for any infringement of the intellectual property rights or other rights of third parties which would result from the use of information contained herein.

The products described in this document are designed, developed and manufactured as contemplated for general use, including without limitation, ordinary industrial use, general office use, personal use, and household use, but are not designed, developed and manufactured as contemplated (1) for use accompanying fatal risks or dangers that, unless extremely high safety is secured, could have a serious effect to the public, and could lead directly to death, personal injury, severe physical damage or other loss (i.e., nuclear reaction control in nuclear facility, aircraft flight control, air traffic control, mass transport control, medical life support system, missile launch control in weapon system), or (2) for use requiring extremely high reliability (i.e., submersible repeater and artificial satellite).

Please note that FUJITSU MICROELECTRONICS will not be liable against you and/or any third party for any claims or damages arising in connection with above-mentioned uses of the products.

Any semiconductor devices have an inherent chance of failure. You must protect against injury, damage or loss from such failures by incorporating safety design measures into your facility and equipment such as redundancy, fire protection, and prevention of over-current levels and other abnormal operating conditions.

Exportation/release of any products described in this document may require necessary procedures in accordance with the regulations of the Foreign Exchange and Foreign Trade Control Law of Japan and/or US export control laws.

The company names and brand names herein are the trademarks or registered trademarks of their respective owners.

Edited Strategic Business Development Dept.

©2008 FUJITSU MICROELECTRONICS LIMITED Printed in Japan
2008.1