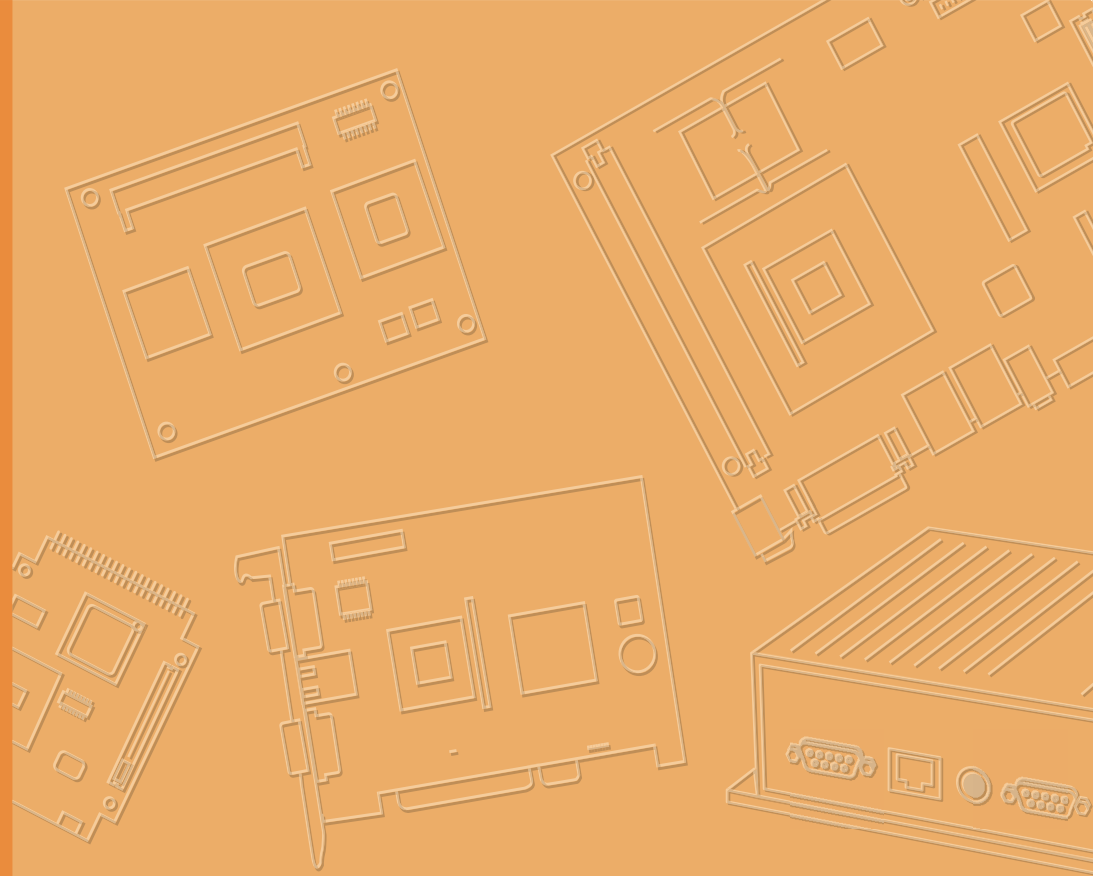


User Manual



UTC-320

**Intel® Platform Processor-
based Ubiquitous Touch
Computer with 21.5" TFT LCD**

ADVANTECH

Enabling an Intelligent Planet

Copyright

The documentation and the software included with this product are copyrighted 2016 by Advantech Co., Ltd. All rights are reserved. Advantech Co., Ltd. reserves the right to make improvements in the products described in this manual at any time without notice. No part of this manual may be reproduced, copied, translated or transmitted in any form or by any means without the prior written permission of Advantech Co., Ltd. Information provided in this manual is intended to be accurate and reliable. However, Advantech Co., Ltd. assumes no responsibility for its use, nor for any infringements of the rights of third parties, which may result from its use.

Acknowledgements

Award is a trademark of Award Software International, Inc. Intel® and Celeron® are trademarks of Intel Corporation.

IBM, PC/AT, PS/2 and VGA are trademarks of International Business Machines Corporation.

Intel® and Pentium® are trademarks of Intel Corporation.

Microsoft Windows® is a registered trademark of Microsoft Corp. RTL is a trademark of Realtek Semiconductor Co., Ltd.

All other product names or trademarks are properties of their respective owners.

For more information on this and other Advantech products, please visit our websites at:

<http://www.advantech.com>

For technical support and service, please visit our support website at:

<http://support.advantech.com>

This manual is for the UTC-320.

Declaration of Conformity

FCC Class A

Note: This equipment has been tested and found to comply with the limits for a Class B digital device, pursuant to part 15 of the FCC Rules. These limits are designed to provide reasonable protection against harmful interference in a residential installation. This equipment generates, uses and can radiate radio frequency energy and, if not installed and used in accordance with the instructions, may cause harmful interference to radio communications. However, there is no guarantee that interference will not occur in a particular installation. If this equipment does cause harmful interference to radio or television reception, which can be determined by turning the equipment off and on, the user is encouraged to try to correct the interference by one or more of the following measures:

- Reorient or relocate the receiving antenna.
- Increase the separation between the equipment and receiver.
- Connect the equipment into an outlet on a circuit different from that to which the receiver is connected.
- Consult the dealer or an experienced radio/TV technician for help.

Warning! *Any changes or modifications made to the equipment which are not expressly approved by the relevant standards authority could void your authority to operate the equipment.*



Packing List

Before you begin installing UTC-320, please make sure that the following materials have been shipped:

- UTC-320 series
- Accessories for UTC-320
 - Warranty card
 - 1 x adapter
 - 1 x SATA cable
 - Packet of screws

If any of these items are missing or damaged, contact your distributor or sales representative immediately.

Technical Support and Assistance

1. Visit the Advantech web site at <http://support.advantech.com> where you can find the latest information about the product.
2. Contact your distributor, sales representative, or Advantech's customer service center for technical support if you need additional assistance. Please have the following information ready before you call:
 - Product name and serial number
 - Description of your peripheral attachments
 - Description of your software (operating system, version, application software, etc.)
 - A complete description of the problem
 - The exact wording of any error messages

Safety Instructions

1. Read these safety instructions carefully.
2. Keep this User Manual for later reference.
3. Disconnect this equipment from any AC outlet before cleaning. Use a damp cloth. Do not use liquid or spray detergents for cleaning.
4. For plug-in equipment, the power outlet socket must be located near the equipment and must be easily accessible.
5. Keep this equipment away from humidity.
6. Put this equipment on a reliable surface during installation. Dropping it or letting it fall may cause damage.
7. The openings on the enclosure are for air convection. Protect the equipment from overheating. **DO NOT COVER THE OPENINGS.**
8. Make sure the voltage of the power source is correct before connecting the equipment to the power outlet.
9. Position the power cord so that people cannot step on it. Do not place anything over the power cord.
10. All cautions and warnings on the equipment should be noted.
11. If the equipment is not used for a long time, disconnect it from the power source to avoid damage by transient overvoltage.
12. Never pour any liquid into an opening in the device. This may cause fire or electrical shock.
13. Never open the equipment. For safety reasons, the equipment should be opened only by qualified service personnel.
14. If one of the following situations arises, get the equipment checked by service personnel:
 15. The power cord or plug is damaged.
 16. Liquid has penetrated into the equipment.
 17. The equipment has been exposed to moisture.
 18. The equipment does not work well, or you cannot get it to work according to the user's manual.
 19. The equipment has been dropped and damaged.
 20. The equipment has obvious signs of breakage.
21. **DO NOT LEAVE THIS EQUIPMENT IN AN ENVIRONMENT WHERE THE STORAGE TEMPERATURE MAY GO BELOW -20° C (-4° F) OR ABOVE 60° C (140° F). THIS COULD DAMAGE THE EQUIPMENT. THE EQUIPMENT SHOULD BE IN A CONTROLLED ENVIRONMENT.**
22. **CAUTION: DANGER OF EXPLOSION IF BATTERY IS INCORRECTLY REPLACED. REPLACE ONLY WITH THE SAME OR EQUIVALENT TYPE RECOMMENDED BY THE MANUFACTURER, DISCARD USED BATTERIES ACCORDING TO THE MANUFACTURER'S INSTRUCTIONS.**
23. The sound pressure level at the operator's position according to IEC 704-1:1982 is no more than 70 dB (A).

DISCLAIMER: This set of instructions is given according to IEC 704-1. Advantech disclaims all responsibility for the accuracy of any statements contained herein.

Contents

Chapter 1	General Information	1
1.1	Introduction	2
1.2	General Specifications	2
1.2.1	General	2
1.2.2	Standard PC Functions.....	2
1.2.3	Audio Function.....	2
1.2.4	LAN Function	2
1.2.5	Touch screen (Optional)	3
1.2.6	Environment.....	3
1.3	LCD Specifications.....	4
1.4	Optional modules	4
1.5	Dimensions	5
	Figure 1.1 Dimensions of UTC-320	5
Chapter 2	System Setup.....	7
2.1	A Quick Tour of the UTC-320.....	8
	Figure 2.1 Front view of UTC-320	8
	Figure 2.2 Rear view of UTC-320	8
2.2	Installation Procedures.....	9
2.2.1	Connecting the power cord	9
2.2.2	Connecting the keyboard or mouse	9
2.2.3	Switching on the power.....	9
	Figure 2.3 Connect the power cord to the DC inlet.....	9
2.3	Running the BIOS Setup Program	10
2.4	Installing System Software	12
2.4.1	Method 1: Ethernet	12
2.4.2	Method 2: External USB CD-ROM.....	12
2.5	Installing the Drivers.....	12
Chapter 3	Hardware Installation and Upgrades ...	13
3.1	Introduction	14
3.2	Installing the 2.5" Hard Disk Drive (HDD)	14
	Figure 3.1 Installing primary 2.5" HDD	14
3.3	Installing the mSATA Card	15
	Figure 3.2 Installing the mSATA Card	15
3.4	Installing the WLAN.....	16
Chapter 4	Jumper Settings and Connectors	19
4.1	Jumpers and Connectors	20
4.1.1	Setting jumpers	20
4.1.2	Jumpers and connectors.....	21
	Table 4.1: Jumpers and Connector Functions.....	21
4.1.3	Locating jumpers and connectors	22
	Figure 4.1 Jumpers and Connectors on UTC-320.....	22
4.2	Jumpers	23
4.2.1	Jumper List	23
	Table 4.2: Jumper List.....	23

4.2.2	Jumper Settings.....	23
	Table 4.3: JP1:LCD PWM POWER.....	23
	Table 4.4: JP2:LCD ENABLE POWER	23
	Table 4.5: JP3:LCD POWER	24
	Table 4.6: JP4: TOUCH POWER.....	24
	Table 4.7: JP5: AT/ATX POWER SEL	24
	Table 4.8: JP6: CLEAR CMOS	25
	Table 4.9: CN9:COM1 /COM2 RING POWER.....	25
	Table 4.10:CN10: CSAFE Power	25

Appendix A I/O Pin Assignments 27

A.1	PIN Assignments	28
	Table A.1: CN1: Backlight.....	28
	Table A.2: CN2: Internal USB.....	28
	Table A.3: CN3:SATA POWER	29
	Table A.4: CN4: LVDS	29
	Table A.5: CN5: SATA.....	31
	Table A.6: CN9:Touch	31
	Table A.7: CN13:DDR3L SODIMM.....	32
	Table A.8: MINIPCI1:MINIPCI	33
	Table A.9: MSATA1: MSATA.....	34
	Table A.10:CN11:CSAFE	36
	Table A.11:CN13: COM2.....	37
	Table A.12:CN14: COM1.....	38
	Table A.13:CN15: SPEAKER	38
	Table A.14:CN21: Line-out	39
	Table A.15:CN22: MIC-IN.....	39
	Table A.16:CN17: LAN1/LAN2	39
	Table A.17:CN24: HDMI	40
	Table A.18:CN19:External USB.....	41
	Table A.19:CN20:External USB.....	42
	Table A.20:CN18: External USB.....	43
	Table A.21:CN23: RJ11	43
	Table A.22:SW2 BUTTON: Power button.....	44
	Table A.23:CN31: DC-IN	44
	Table A.24:VGA.....	45

Chapter 1

General Information

This chapter gives background information on the UTC-320.

Sections include:

- Introduction
- General Specifications
- LCD Specifications
- Dimensions

1.1 Introduction

UTC-320 is a multi-purpose all-in-one computing system equipped with a wide format, touch based LCD panel. It is easy to integrate key peripherals and display systems for diversified self-service and interactive signage deployed in different locations. With its removable frame, the system could also fulfill control system applications with its panel mounting design.

1.2 General Specifications

1.2.1 General

- **Dimensions:** 520.2 mm (L) x 316.1 mm (H) x 45.9 mm (D)
- **Weight:** 6.5 kg
- **Power adaptor:** AC/DC (Standard Build in) 12 V, 84 W
Input voltage: 100 ~ 240 V_{AC}
Output voltage: 12 V @ 7 A
- **Disk drive housing:** Space for one 2.5" SATA HDD
- **Front panel:** IP65

1.2.2 Standard PC Functions

- **CPU:** Intel® Haswell or Baytrail with 3 MB L2 cache
- **BIOS:** AMI 16 MB Flash BIOS via SPI
- **System chipset:** Intel® Haswell or Baytrail
- **System memory:** 1 x SO-DIMM DDR3L 1333 MHz up to 8 GB
- **Serial ports:** 1 x RS-232 COM , 1 x RS-232 / 422 / 485
- **Universal serial bus (USB) port:** Supports up to 2 x USB 2.0 / 4 x USB 3.0
- **Mini PCI-E bus expansion slot:** Accepts one mini PCI-E device (wireless LAN card)
- **Watchdog timer:** Single chip Watchdog 255-level interval timer, setup by software
- **Power management:** Full ACPI (Advanced Configuration and Power Interface) 2.0 Supports S0, S1, S3,S4, S5

1.2.3 Audio Function

- **Audio:** High Definition Audio (HD), 1 W x 2 Speakers
- Optional - Audio output function

1.2.4 LAN Function

- **Chipset:**
 - LAN1 Intel I218LM, LAN2 Intel WGI211AT for Core i
 - LAN1 Intel WGI211AT, LAN2 Intel WGI211AT for Celeron
- **Speed:** 1000 Mbps /Interface: 2 x RJ45
- **Wake-on-LAN:** Supports Wake-on-LAN function with ATX power control
- Supports LAN teaming (in fault tolerance)

1.2.5 Touch screen (Optional)

Type	Analog Resistive 5-wires (Res. Flat Glass) / Projected Capacitive Touch Panel (Pcap. Flat Glass)
Light Transmission	80%
Controller	USB interface
Durability (touches in a lifetime)	36 million

1.2.6 Environment

- **Operating temperature:** 0 ~ 40° C (32 ~ 104° F)
- **Storage temperature:** -20 ~ 60° C
- **Relative humidity:** 10 ~ 90% @ 40° C (non-condensing)
- **Shock:** 10 G peak acceleration (11 ms duration)
- **Certification:** EMC: CE, FCC, BSMI, VCCI.
Safety: UL 60950, CB, CCC, BSMI
- **Vibration:** 5 ~ 500 Hz 0.5 G RMS Random vibration
- **VESA Support:** 100 x 100 mm (screw type- M4 x 8)

Caution! Use suitable mounting apparatus to avoid risk of injury.



- Supports landscape and portrait screen modes.

Note! Please follow suggestion to install UTC-320 Models.



1.3 LCD Specifications

- **Display type:** 21.5" TFT LCD
- **Max. resolution:** 1920 x 1080
- **Colors:** 16.7 M
- **Pixel Pitch (um):** 248.25 (H) x 248.25 (V)
- **View Angle:** 89°/89°
- **Luminance:** 200 cd/m²

Note! *The color LCD display installed in the UTC-320 is high-quality and reliable. However, it may contain a few defective pixels which do not always illuminate. With current technology, it is impossible to completely eliminate defective pixels. Advantech is actively working to improve this technology.*



1.4 Optional modules

- **Memory:** 1 x SO-DIMM DDR3L 1333 MHz up to 8 GB
- **HDD:** 2.5" SATA HDD
- **Operating System:** Windows Embedded Standard 7, Windows Embedded Standard 8.1, Embedded Linux 3.0, Windows Embedded Standard 10
- **Touchscreen:** Analog resistive (Optional - PCT solution)
- **Power cord:** 1702002600 (US) 1702002605 (Europe)
- **Wireless LAN Module:**

Part No.	Description
968EMW0071	Wireless 802.11abgn AR9382 2T2R Full-size DNXA-1
1750006682-01	Main antenna wireless 200 mm

1.5 Dimensions

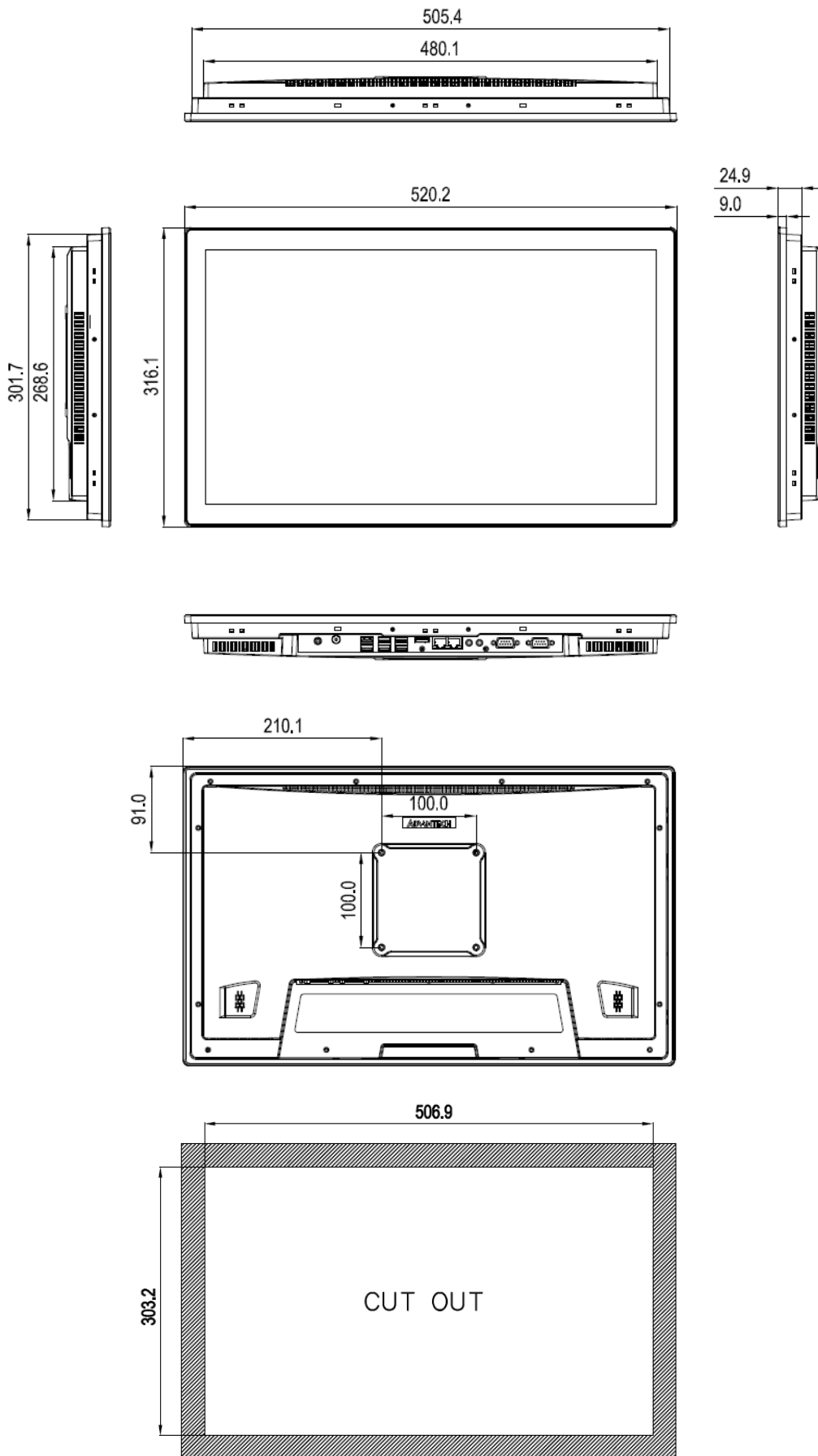


Figure 1.1 Dimensions of UTC-320

Chapter 2

System Setup

This chapter details system setup on the UTC-320.

Sections include:

- A Quick Tour of the UTC-320
- Installation procedures
- Running the BIOS Setup Program
- Installing System Software

2.1 A Quick Tour of the UTC-320

Before you start to set up the UTC-320, take a moment to become familiar with the locations and purposes of the controls, drives, connectors and ports, which are illustrated in the figures below.

When you place the UTC-320 upright on the desktop, its front panel appears as shown in Figure 2.1.

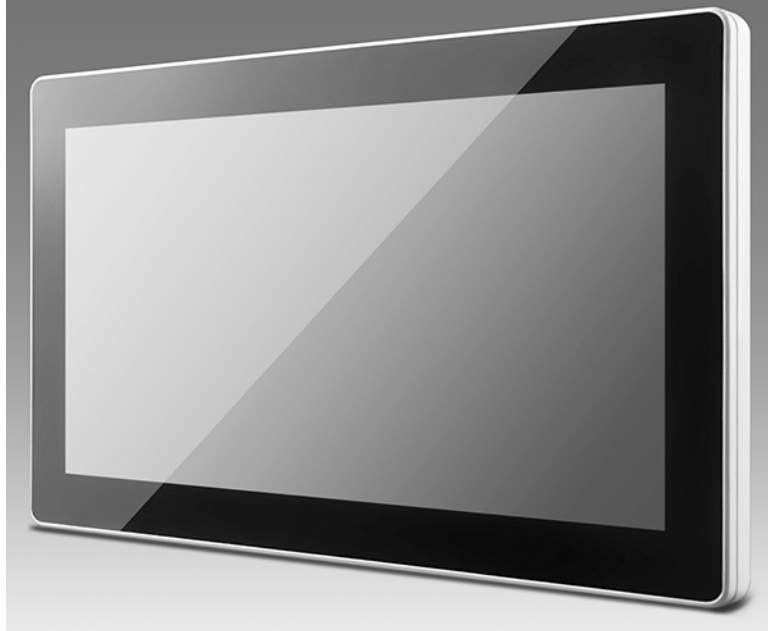
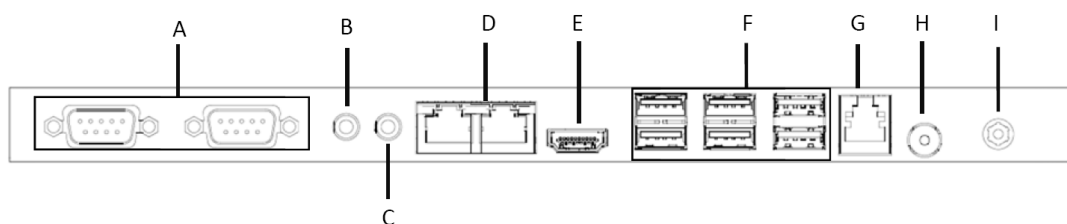


Figure 2.1 Front view of UTC-320

When you turn the UTC-320 around and look at its rear cover, you will find the I/O section as shown in Fig. 2.2. (The I/O section includes various I/O ports, including serial ports, Ethernet ports, USB ports, HDMI, and LINE-OUT / MIC-IN, RJ11, DC-IN, Power button.)



Figure 2.2 Rear view of UTC-320



- | | |
|---------------------------|--|
| A. COM Port | B. Line-out |
| C. MIC-IN | D. Gigabit LAN x2 |
| E. HDMI or VGA (optional) | F. USB3.0 x4, USB2.0 x2 for Core i
USB2.0 x5, USB3.0 x1 for Celeron |
| G. RJ11 (optional) | H. Power switch |
| I. DC-IN | |

2.2 Installation Procedures

2.2.1 Connecting the power cord

The UTC-320 can be powered by a DC electrical outlet. Be sure to always handle the power cords by holding the plug ends only. Please follow the Figure 2.3 to connect the male plug of the power cord to the DC inlet of the UTC-320.

2.2.2 Connecting the keyboard or mouse

Before you start the computer, please connect keyboard port on the I/O section of the UTC-320.

2.2.3 Switching on the power

When you look at the rear side of the UTC-320, you will see the power switch as shown in Figure 2.3.



Figure 2.3 Connect the power cord to the DC inlet

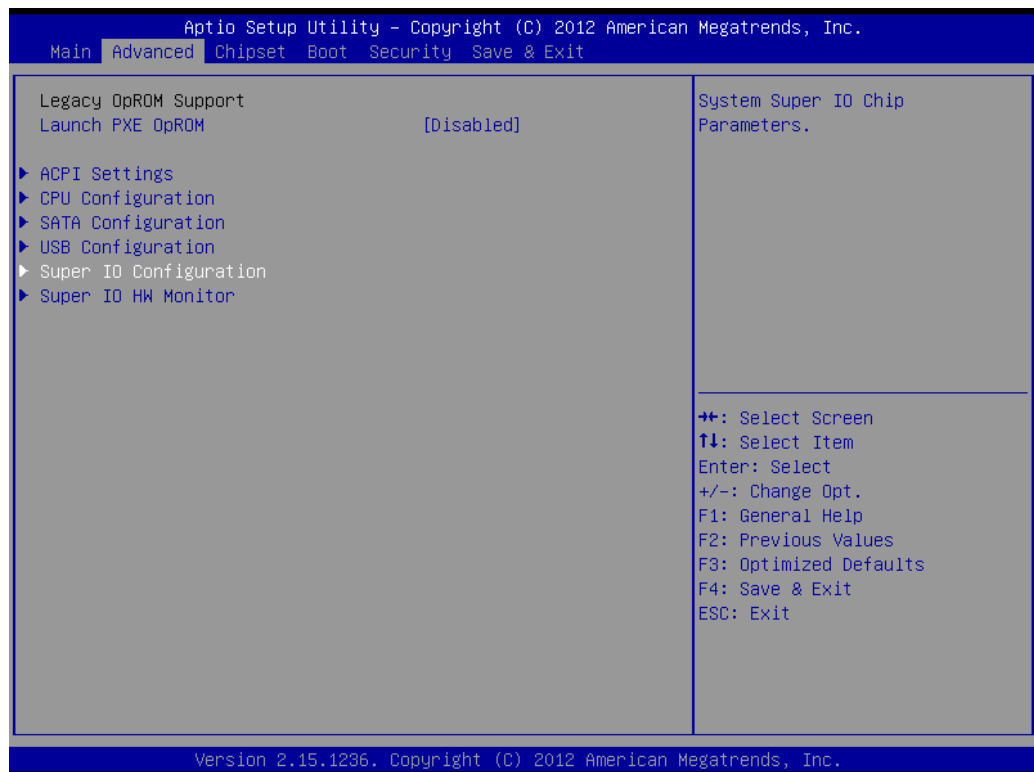
2.3 Running the BIOS Setup Program

Your UTC-320 is likely to have been properly set up and configured by your dealer prior to delivery. You may still find it necessary to use the UTC-320's BIOS (Basic Input-Output System) setup program to change system configuration information, such as the current date and time or your type of hard drive. The setup program is stored in read-only memory (ROM). It can be accessed either when you turn on or reset the UTC-320, by pressing the "Del" key on your keyboard immediately after powering on the computer.

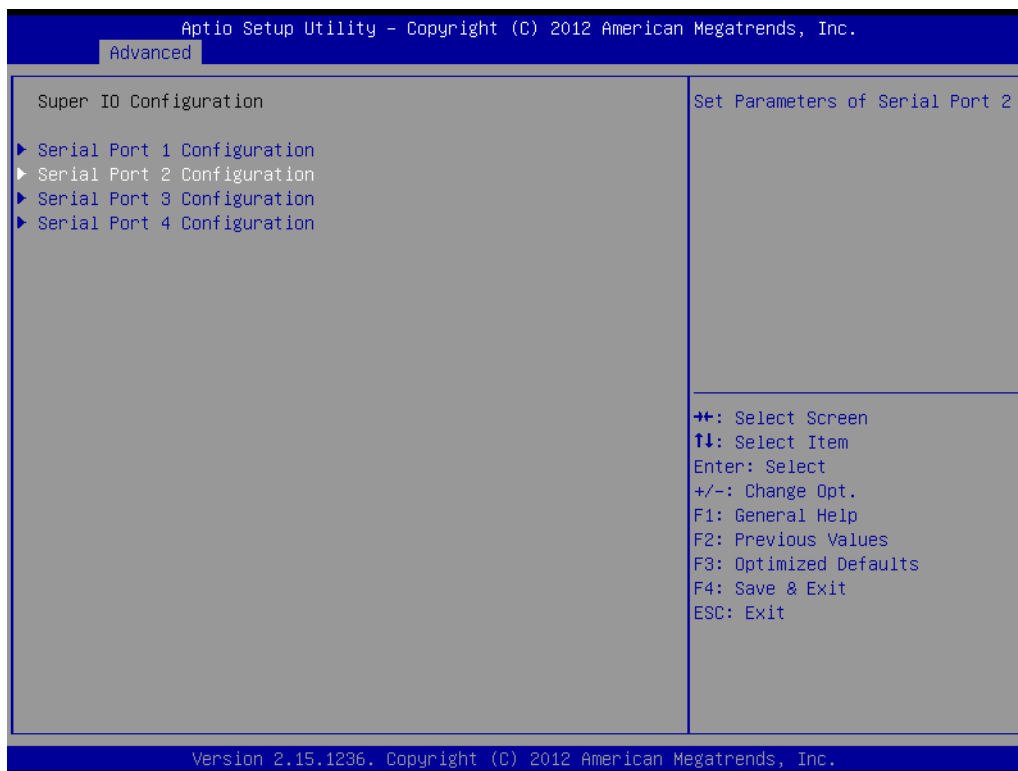
The settings you specify with the setup program are recorded in a special area of memory called CMOS RAM. This memory is backed up by a battery so that it will not be erased when you turn off or reset the system. Whenever you turn on the power, the system reads the settings stored in CMOS RAM and compares them to the equipment check conducted during the power on self-test (POST). If an error occurs, an error message will be displayed on screen, and you will be prompted to run the setup program.

COM2 RS232/RS422/RS485 Selection:

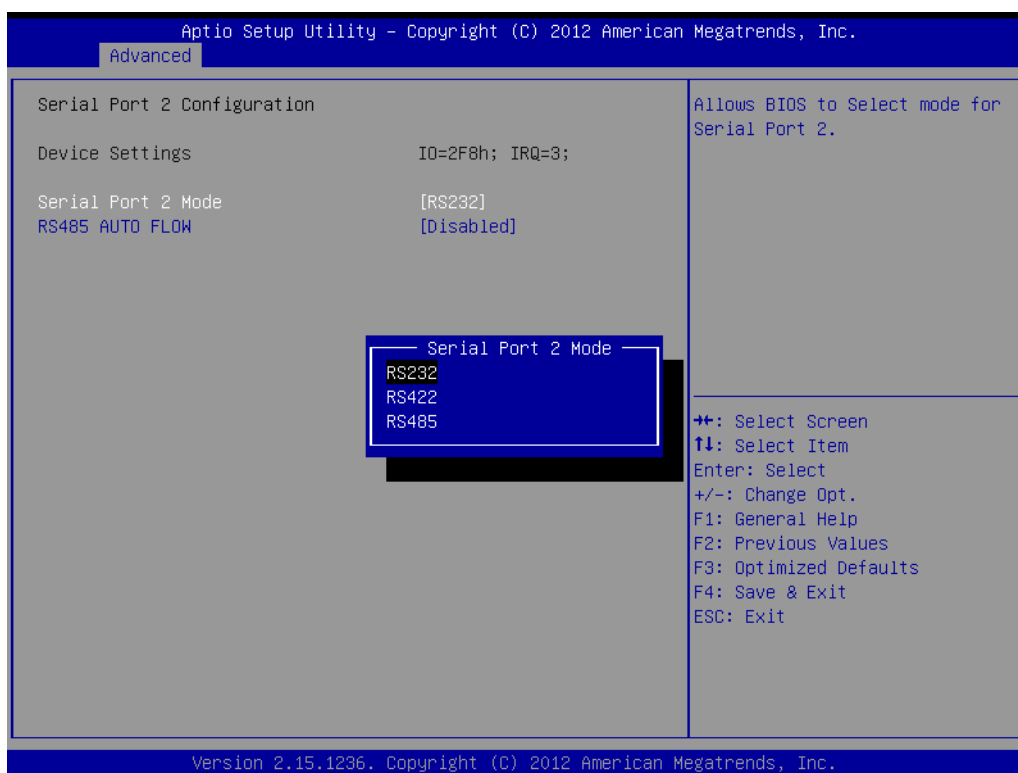
Enter Into BIOS setup → Advanced → Super IO Configuration.



Select Serial Port 2 Configuration.



Change Serial Port 2 Mode [RS232/RS422/RS485].



2.4 Installing System Software

Recent releases of operating systems from major vendors include setup programs which load automatically and guide you through hard disk preparation and operating system installation. The guidelines below will help you determine the steps necessary to install your operating system on the UTC-320 hard drive.

Note! *Some distributors and system integrators may have already pre-installed system software prior to shipment of your UTC-320.*



Installing software requires an installed HDD. Software can be loaded in the UTC-320 using any of four methods:

2.4.1 Method 1: Ethernet

You can use the Ethernet port to download software to the HDD.

2.4.2 Method 2: External USB CD-ROM

If required, insert your operating system's installation or setup diskette into the diskette drive until the release button pops out.

The BIOS of UTC-320 supports system boot-up directly from the CD-ROM drive. You may also insert your system installation CD-ROM into the CD-ROM drive.

Power on your UTC-320 or reset the system by pressing the "Ctrl+Alt+Del" keys simultaneously. The UTC-320 will automatically load the operating system from the diskette or CD-ROM.

If you are presented with the opening screen of a setup or installation program, follow the instructions on screen. The setup program will guide you through preparation of your hard drive, and installation of the operating system. If you are presented with an operating system command prompt, such as A:\>, then you must partition and format your hard drive, and manually copy the operating system files to it. Refer to your operating system user manual for instructions on partitioning and formatting a hard drive.

2.5 Installing the Drivers

After installing your system software, you will be able to set up Ethernet, chipset, graphics, audio, USB 3.0 and touchscreen functions; download the drivers from the Advantech website.

www.advantech.com

Note! *The drivers and utilities used for the UTC-320 are subject to change without notice.*



If in doubt, check Advantech's website or contact our application engineers for the latest information regarding drivers and utilities.

Chapter 3

Hardware Installation and Upgrades

This chapter details installing the UTC-320 hardware.

Sections include:

- Overview of Hardware Installation and Upgrading
- Installing the 2.5" Hard Disk Drive (HDD)
- Installing the mSATA
- Installing the WLAN

3.1 Introduction

The UTC-320 consists of a PC-based computer that is housed in a plastic enclosure. You can install a HDD, DRAM, and MiniSATA card by removing the rear cover. Any maintenance or hardware upgrades can be easily completed after removing the rear cover.

Warning! Do not remove the rear cover until you have verified that no power is flowing within the UTC-320. Power must be switched off and the power cord must be unplugged. Every time you service the UTC-320, you should be aware of this.



3.2 Installing the 2.5" Hard Disk Drive (HDD)

You can attach one Serial Advanced Technology Attachment (SATA) hard disk drive to the UTC-320's internal controller. The SATA controller supports faster data transfer and allows the SATA hard drive to exceed 150 MB. The following are instructions for installation:

1. Detach and remove the rear cover.
2. Place the HDD in the metal bracket, and tighten the screws (see Figure 3.1).
3. The HDD cable (SATA 7P+1*5P-2.5/SATA(15+7)P) is next to the metal brace. Connect the HDD cable to the motherboard (SATA1/SATA POWER). Plug the other end of the cable into the SATA hard drive.
4. Put the rear cover on and tighten the screws.

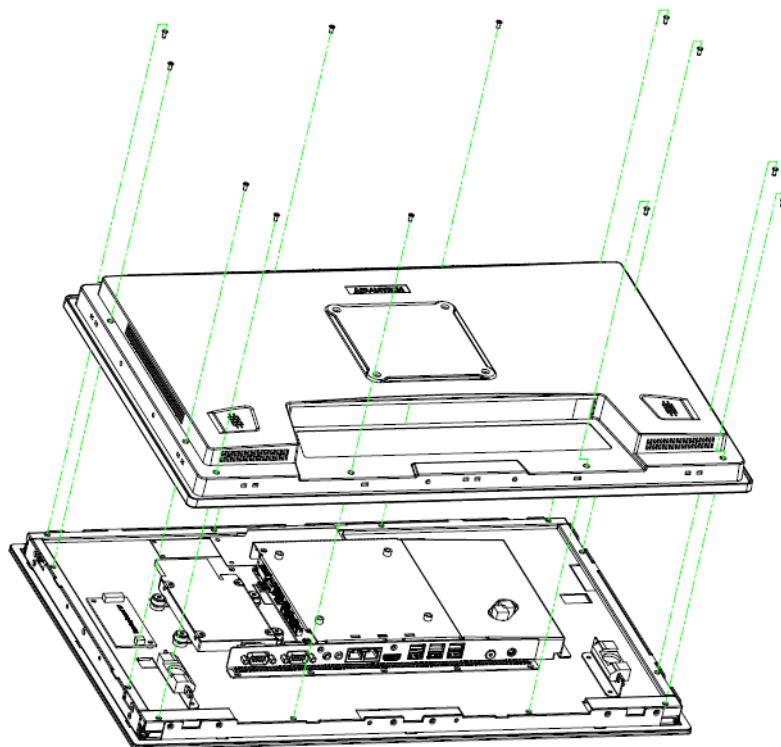


Figure 3.1 Installing primary 2.5" HDD

3.3 Installing the mSATA Card

1. Remove 12 screws on the back cover.
2. Remove 6 screws on the reinforced board.

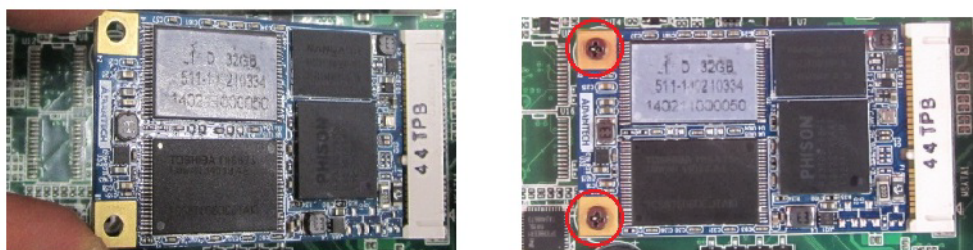
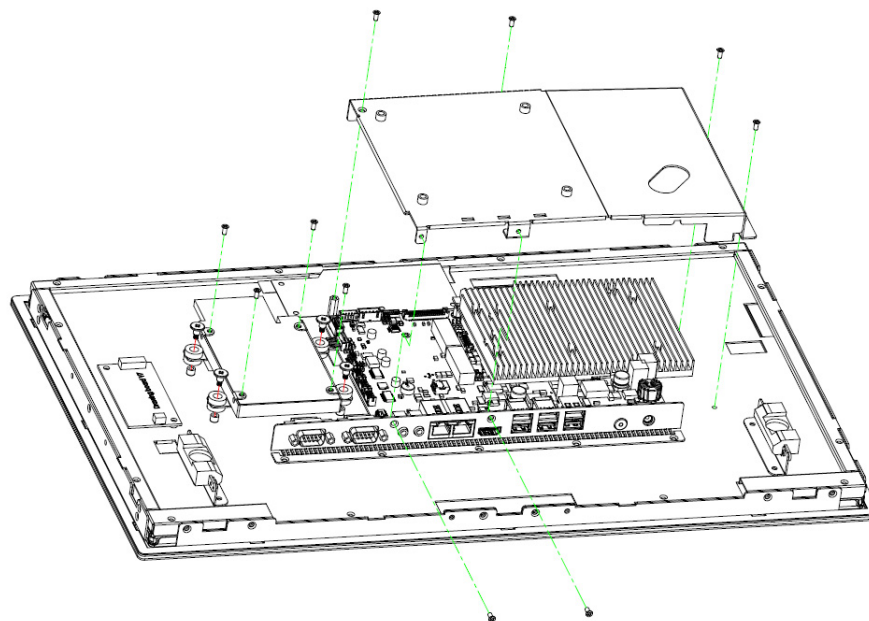
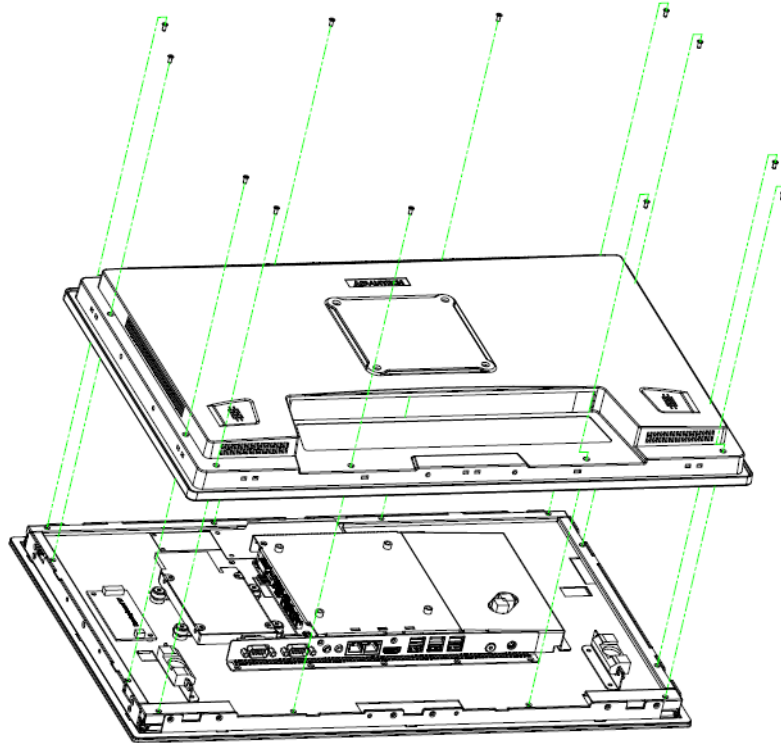


Figure 3.2 Installing the mSATA Card

3.4 Installing the WLAN

Reserve two locations for the external Antenna. One is at the IO port, the other is at the rear cover. Customers can choose based on their requirement.

1. Remove 12 x screws from the back cover.



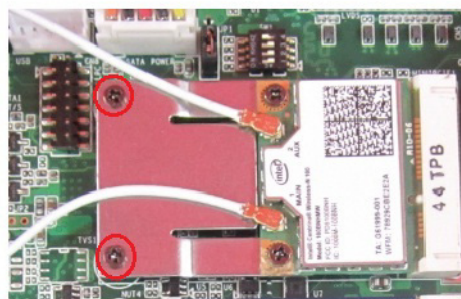
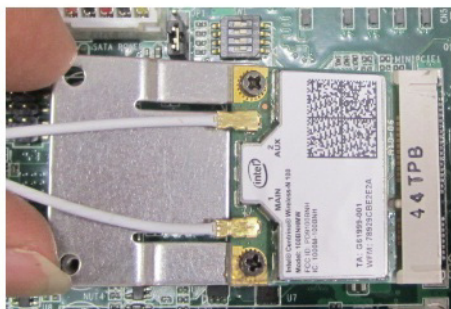
2. Remove 6 screws on the reinforced board.
3. Coaxial cable (Advantech P/N: 1750006682-01)



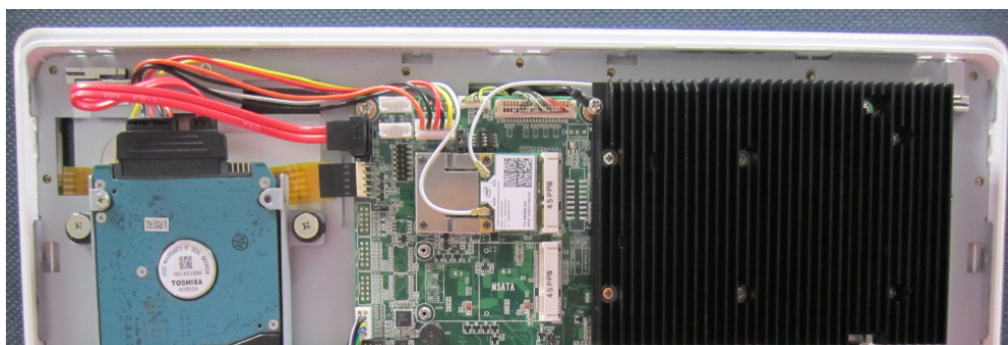
4. Connect the coaxial cable to "ANT1" on the WLAN card.



5. Install the WLAN card on M/B bottom side.



6. Cable routing of the wireless antenna is shown below.



Chapter 4

Jumper Settings and Connectors

This chapter tells how to set up the UTC-320 hardware, including instructions on setting jumpers and connecting peripherals, switches and indicators. Be sure to read all the safety precautions before you begin the installation procedures.

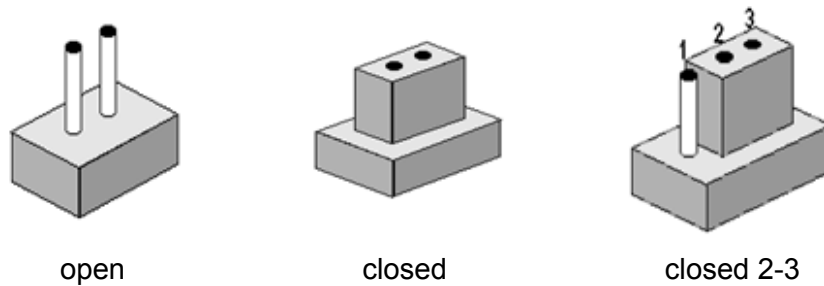
Sections include:

- Jumpers and Connectors
- CMOS Clear for External RTC (JP3)
- COM Port Interface
- Watchdog Timer Configuration

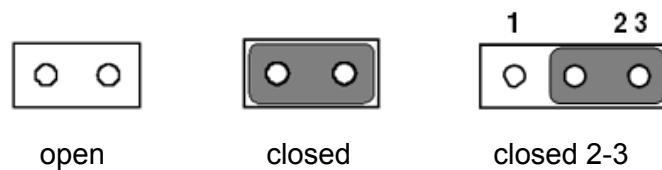
4.1 Jumpers and Connectors

4.1.1 Setting jumpers

You can configure your UTC-320 to match the needs of your application by setting jumpers. A jumper is the simplest kind of electrical switch. It consists of two metal pins and a small metal clip (often protected by a plastic cover) that slides over the pins to connect them. To 'close' a jumper, you connect the pins with the clip. To 'open' a jumper you remove the clip. Sometimes a jumper will have three pins, labeled 1, 2, and 3. In this case, you would connect either pins 1 and 2 or pins 2 and 3.



The jumper settings are schematically depicted in this manual as follows:.



A pair of needle-nose pliers may be helpful when working with jumpers. If you have any doubts about the best hardware configuration for your application, contact your local distributor or sales representative before you make any changes.

4.1.2 Jumpers and connectors

The motherboard of the UTC-320 has a number of jumpers and connectors that allow you to configure your system to suit your applications. The table below lists the function of each of the board's jumpers.

Table 4.1: Jumpers and Connector Functions

Label	Function
CN1	Back_Light
CN2	Internal USB
CN3	SATA POWER
CN4	LVDS
CN5	SATA
CN6	Touch
CN9	Touch
DIMM1	DDR3L SODIMM
MINIPCIE1	MINIPCIE
MSATA1	MSATA
CN11	CSAFE
CN13	COM2
CN14	COM1
CN15	Speaker
CN21	Line-out
CN22	MIC-IN
CN17	LAN1/LAN2
CN24	HDMI
CN19	External USB
CN20	External USB
CN18	External USB
CN23	RJ11
SW2	Power button
CN25	DC-IN

4.1.3 Locating jumpers and connectors

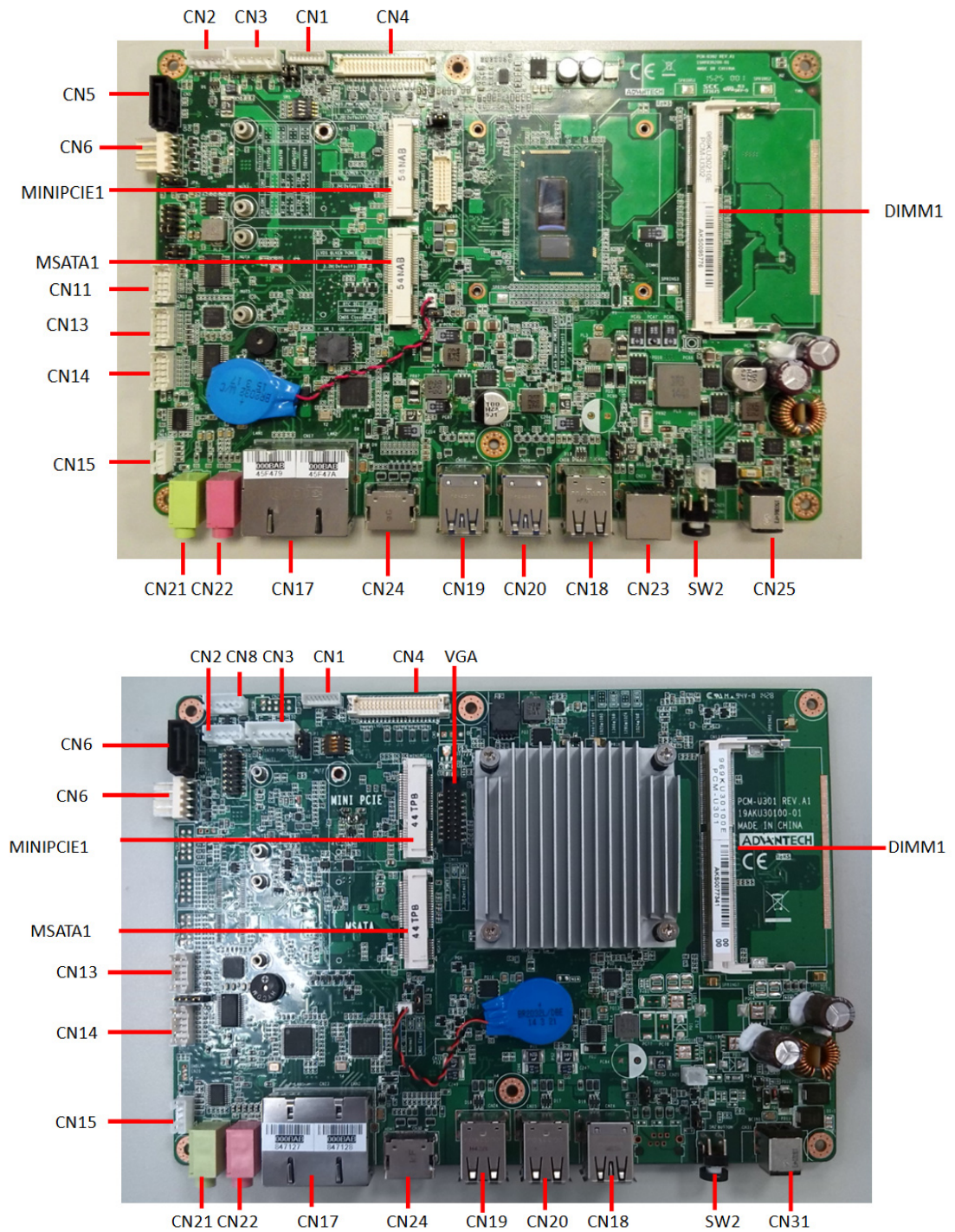


Figure 4.1 Jumpers and Connectors on UTC-320

4.2 Jumpers

4.2.1 Jumper List

Table 4.2: Jumper List

JP1	LCD PWM POWER
JP2	LCD ENABLE POWER
JP3	LCD POWER
JP4	TOUCH POWER
JP5	AT/ATX POWER SEL
JP6	Clear CMOS
CN9	COM1/COM2 RING POWER
CN10	CSAFE POWER

4.2.2 Jumper Settings

Table 4.3: JP1:LCD PWM POWER

Part Number	1653003101
Footprint	HD_3x1P_79_D
Description	PIN HEADER 3x1P 2.0mm 180D(M) DIP 2000-13 WS
Setting	Function
(1-2)	5V
(2-3)*	3.3V

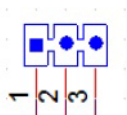


Table 4.4: JP2:LCD ENABLE POWER

Part Number	1653003101
Footprint	HD_3x1P_79_D
Description	PIN HEADER 3x1P 2.0mm 180D(M) DIP 2000-13 WS
Setting	Function
(1-2)	5V
(2-3)*	3.3V

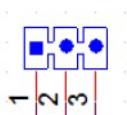
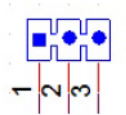
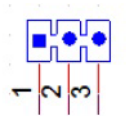


Table 4.5: JP3:LCD POWER

Part Number	1653003100
Footprint	HD_3x1P_100_D
Description	PIN HEADER 3x1P 2.54mm 180D(M) DIP 1130-000-03S
Setting	Function
(1-2)	5V
(2-3)*	3.3V

**Table 4.6: JP4: TOUCH POWER**

Part Number	1653003101
Footprint	HD_3x1P_79_D
Description	PIN HEADER 3x1P 2.0mm 180D(M) DIP 2000-13 WS
Setting	Function
(1-2)*	+3.3V
(2-3)	+3.3VSB

**Table 4.7: JP5: AT/ATX POWER SEL**

Part Number	1653005101
Footprint	HD_5x1P_79_D
Description	PIN HEADER 3x1P 2.0mm 180D(M) DIP 2000-13 WS
Setting	Function
(1-2)	AT
(2-3)*	ATX

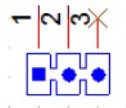


Table 4.8: JP6: CLEAR CMOS

Part Number	1653005101
Footprint	HD_5x1P_79_D
Description	PIN HEADER 3x1P 2.0mm 180D(M) DIP 2000-13 WS
Setting	Function
(1-2)	Clear CMOS
(2-3)*	Normal

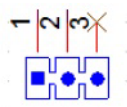


Table 4.9: CN9:COM1 /COM2 RING POWER

Part Number	1653005261
Footprint	HD_5x2P_79
Description	PIN HEADER 5x2P 2.0mm 180D(M) SMD 21N22050
Setting	Function
(1-3) *	COM1 RING
(3-5)	COM1 RI output +5V
(7-9)	COM1 RI output +12V
(2-4) *	COM2 RING
(4-6)	COM2 RI output +5V
(8-10)	COM2 RI output +12V

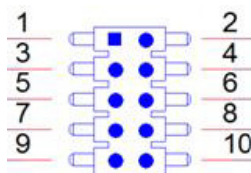
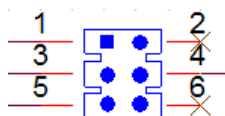


Table 4.10: CN10: CSAFE Power

Part Number	1653003201
Footprint	HD_3x2P_79_D
Description	PIN HEADER 3x2P 2.0mm 180D(M) DIP 21N22050
Setting	Function
(1-3) *	CSAFE output +5V
(3-4)	CSAFE output +9V
(3-5)	CSAFE output +12V



Appendix **A**

I/O Pin Assignments

A.1 PIN Assignments

Table A.1: CN1: Backlight

Part Number	1655004512-01
Footprint	WF_8P_49_BOX_D
Description	WAFER BOX 8P 1.25mm 180D(M) DIP A1251WV0-8P
Pin	Pin name
1	+12V_INVERTER
2	+12V_INVERTER
3	GND
4	GND
5	BKLT_EN
6	BRIGHT1
7	+12V_INVERTER
8	GND

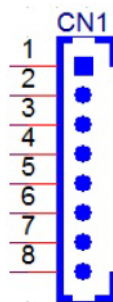


Table A.2: CN2: Internal USB

Part Number	1655000453
Footprint	WHL5V-2M-24W1140
Description	WAFER BOX 2.0mm 5P 180D(M) DIP WO/Pb JIH VEI
Pin	Pin name
1	+5V
2	D-
3	D+
4	GND
5	GND

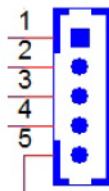
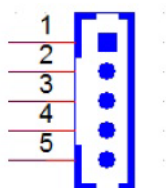


Table A.3: CN3:SATA POWER

Part Number	1659254005
Footprint	SATA_7P_WATM-07DBN4A3B8UW_D
Description	Serial ATA 7P 1.27mm 180D(M) DIP WATM-07DBN4A3B8
Pin	Pin name
1	+3.3V
2	GND
3	+5V
4	GND
5	+12V

**Table A.4: CN4: LVDS**

Part Number	1653920200
Footprint	SPH20X2
Description	B/B Conn. 40P 1.25mm 90D SMD DF13-40DP-1.25V(91)
Pin	Pin name
1	+3.3V or +5V
2	+3.3V or +5V -
3	GND
4	GND
5	+3.3V or +5V
6	+3.3V or +5V
7	LVDS0_D0-
8	LVDS1_D0-
9	LVDS0_D0+
10	LVDS1_D0+
11	GND
12	GND-
13	LVDS0_D1-
14	LVDS1_D1-
15	LVDS0_D1+
16	LVDS1_D1+
17	GND
18	GND
19	LVDS0_D2-
20	LVDS1_D2-
21	LVDS0_D2+
22	LVDS1_D2+-
23	GND
24	GND

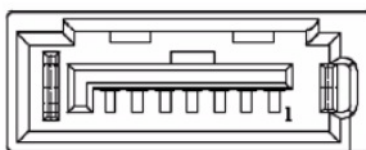
Table A.4: CN4: LVDS

25	LVDS0_CLK-
26	LVDS1_CLK-
27	LVDS0_CLK+
28	LVDS1_CLK+
29	GND
30	GND
31	LVDS0_DDC_SC
32	LVDS0_DDC_SD
33	GND
34	GND
35	LVDS0_D3-
36	LVDS1_D3-
37	LVDS0_D3+
38	LVDS1_D3+
39	+3.3V or +5V
40	+3.3V or +5V



Table A.5: CN5: SATA

Part Number	1654004659
Footprint	WF_5P_98_BOX_D
Description	WAFER BOX 5P 2.5mm 180D(M) DIP 2503-WS-5
Pin	Pin name
1	GND
2	TX+
3	TX-
4	GND
5	RX+
6	RX-
7	GND

**Table A.6: CN9:Touch**

Part Number	1655005110
Footprint	WF_5P_100_RA_D
Description	WAFER 5P 2.54mm 90D(M) DIP 2542-WR-5
Pin	Pin name
1	Y+
2	Y-
3	SENSE
4	X+
5	X-

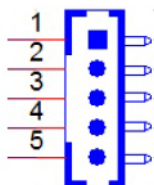


Table A.7: CN13:DDR3L SODIMM

Part Number	1651002087-11
Footprint	DDR3_204P_AS0A626-N2S6-7H
Description	DDR3 SODIMM H=5.2mm STD 204P SMD AS0A626-H2S6-7H
Pin	Pin name
1	VREF_DQ
2	GND
3	GND
4	DQ4
5	DQ0
6	DQ5
7	DQ1
8	GND
9	GND
10	DQS0
11	GND
12	GND
13	DQ4
14	DQ0
15	DQ5
16	DQ1
17	GND
18	GND
19	GND
20	GND
21	DQ4
22	DQ0
23	DQ5
24	DQ1
25	GND
26	GND
27	DQS1
28	GND
29	GND
30	DQ4
31	DQ0
32	DQ5
33	DQ1
34	GND
35	GND

Table A.8: MINIPCI1:MINIPCI1	
Part Number	1654002538
Footprint	FOX_AS0B226-S68K7F
Description	MINI PCI E 52P 6.8mm 90D SMD AS0B226-S68Q-7H
Pin	Pin name
1	MPCI1_WAKE#
2	+3.3VSB
3	NC
4	GND
5	NC
6	NC
7	MPCI1_CLKREQ#
8	NC
9	GND
10	NC
11	CLK_MINI_PCI-
12	NC
13	CLK_MINI_PCI+
14	NC
15	GND
16	NC
17	NC
18	GND
19	NC
20	MPCI1_DISABLE#
21	GND
22	PLTRST#
23	PCIE_RX-
24	+3.3VSB
25	PCIE_RX+
26	GND
27	GND
28	+1.5V
29	GND
30	SMB_CLK_MPCI1
31	PCIE_TX-
32	SMB_DAT_MPCI1
33	PCIE_TX+
34	GND
35	GND
36	USB_D-
37	GND
38	USB_D+
39	+3.3VSB
40	GND
41	+3.3VSB
42	NC

Table A.8: MINIPCIE1:MINIPCIE

43	NC
44	NC
45	NC
45	NC
47	NC
48	NC
49	NC
50	GND
51	NC
52	+3.3VSB

Table A.9: MSATA1: MSATA

Part Number	1654002538
Footprint	FOX_AS0B226-S68K7F
Description	MINI PCI E 52P 6.8mm 90D SMD AS0B226-S68Q-7H
Pin	Pin name
1	NC
2	+3.3V
3	NC
4	NC
5	NC
6	NC
7	NC
8	NC
9	GND
10	NC
11	NC
12	NC
13	NC
14	NC
15	GND
16	NC
17	NC
18	GND
19	NC
20	NC
21	GND
22	NC
23	SATA1_RX+
24	+3.3V
25	SATA1_RX-
26	GND
27	GND
28	NC
29	GND
30	NC

Table A.9: MSATA1: MSATA

31	SATA1_TX-
32	NC
33	SATA1_TX+
34	GND
35	GND
36	NC
37	GND
38	NC
39	+3.3V
40	GND
41	+3.3V
42	NC
43	NC
44	NC
45	NC
45	NC
47	NC
48	NC
49	NC
50	GND
51	+3.3V
52	+3.3V

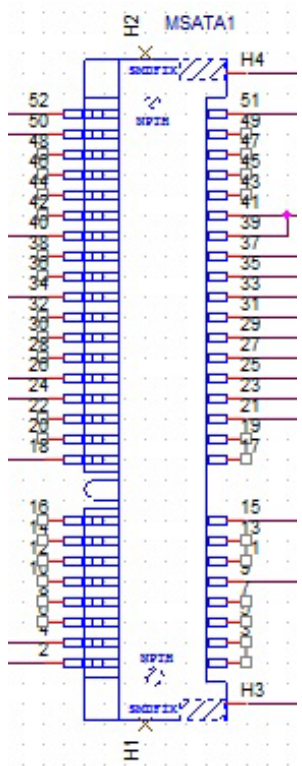


Table A.10: CN11:CSAFE

Part Number	1655000197
Footprint	WF_5x2P_79_BOX_D_P1R
Description	1655_WF_5x2P_79_BOX_D_P1R_0.Normal
Pin	Pin name
1	LINE_IN1_L
2	LINIE_IN1_R
3	COM3_RX+
4	COM3_TX
5	V_CSAFE
6	COM3_CTS#
7	GND
8	GND
9	

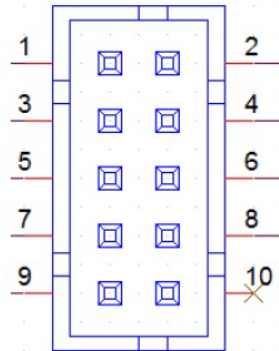
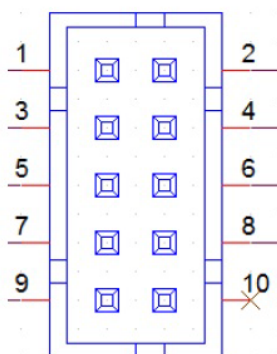


Table A.11: CN13: COM2

Part Number	1655000197
Footprint	WF_5x2P_79_BOX_D_P1R
Description	1655_WF_5x2P_79_BOX_D_P1R_0.Normal
Pin	Pin name
1	422/485 TX-
2	422/485 TX+
3	422 RX+
4	422 RX-
5	GND
6	DSR#
7	RTS#
8	CTS#
9	RI#



UART RS485 Auto Flow Control

COM2 supports RS485 auto flow control function for all UART.

When enabling the RS485 auto control function, it will automatically drive RTS# pin to logic high or low for flow control.

To make this RS485 auto flow control function work, please be noted that the parity and stop-bit setting has to be one of the following three settings:

- (1) 8 data bits + 1 parity bit + 1 stop bit
- (2) 8 data bits + 1 parity bit + 2 stop bits
- (3) 8 data bits + 2 stop bits

Table A.12: CN14: COM1

Part Number	1655000197
Footprint	WF_5x2P_79_BOX_D_P1R
Description	1655_WF_5x2P_79_BOX_D_P1R_0.Normal
Pin	Pin name
1	DCD
2	RXD
3	TXD
4	DTR#
5	GND
6	DSR#
7	RTS#
8	CTS#
9	RI#

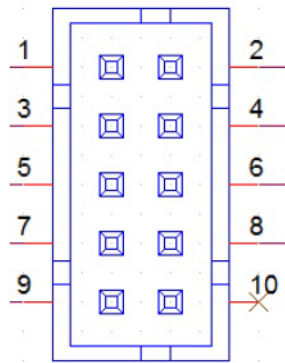


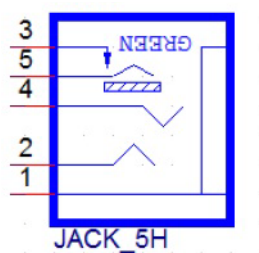
Table A.13: CN15: SPEAKER

Part Number	1655304020
Footprint	WF_4P_79_BOX_R1_D
Description	WAFER BOX 2.0mm 4P 180D(M) W/LOCK A2001WV2-4P
Pin	Pin name
1	AUD_OUTA-
2	AUD_OUTA+
3	AUD_OUTB+
4	AUD_OUTB-

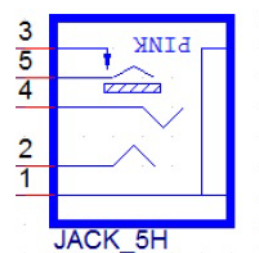


Table A.14: CN21: Line-out

Part Number	1652001586
Footprint	KUONYI_PJ-2508PC-5-L
Description	PHONE JACK 5P 3.5φ 90D(F) AZALIA GREEN DIP WO/P
Pin	Pin name
1	GND
2	OUT_L
3	JD
4	OUT_R
5	GND

**Table A.15: CN22: MIC-IN**

Part Number	1652001584
Footprint	KUONYI_PJ-2508PA-5-L
Description	PHONE JACK 5P 3.5φ 90D(F) AZALIA PINK DIP WO/Pb
Pin	Pin name
1	GND
2	MIC_L
3	JD
4	MIC_R
5	GND

**Table A.16: CN17: LAN1/LAN2**

Part Number	1652003274
Footprint	RJ45_28P_RTB-19GB9J1A
Description	PHONE JACK RJ45 28P DIP RTB-19GB9J1A
Pin	Pin name

Table A.17: CN24: HDMI

Part Number	1654011175-01
Footprint	HDMI_19P_QJ51191-LFB4-7F
Description	HDMI Conn. 19P 0.5mm 90D(F) SMD QJ51191-LFB4-7F
Pin	Pin name
1	HDMI_TX0+
2	GND
3	HDMI_TX0-
4	HDMI_TX1+
5	GND
6	HDMI_TX1-
7	HDMI_TX2+
8	GND
9	HDMI_TX2-
10	HDMI_TX3+
11	GND
12	HDMI_TX3-
13	NC
14	NC
15	HDMI_CLK
16	HDMI_DAT
17	GND
18	+5V
19	HDMI_DET

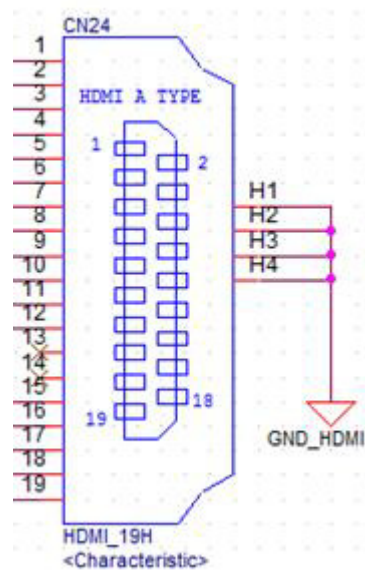


Table A.18: CN19:External USB

Part Number	1654010969-01
Footprint	USB_9x2P_UEA1112C-8HS6-4F
Description	USB CONN. 18P 2.0mm 90D(F) DIP UEA1112C
Pin	Pin name
1	+5VSB
2	D-
3	D+
4	GND
5	SSRX-
6	SSRX+
7	GND
8	SSTX-
9	SSTX+
10	+5VSB
11	D-
12	D+
13	GND
14	SSRX-
15	SSRX+
16	GND
17	SSTX-
18	SSTX+

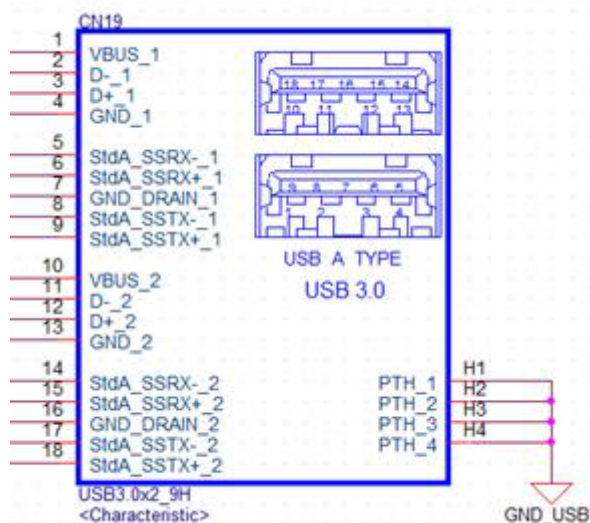


Table A.19: CN20:External USB

Part Number	1654010969-01
Footprint	USB_9x2P_UEA1112C-8HS6-4F
Description	USB CONN. 18P 2.0mm 90D(F) DIP UEA1112C
Pin	Pin name
1	+5VSB
2	D-
3	D+
4	GND
5	SSRX-
6	SSRX+
7	GND
8	SSTX-
9	SSTX+
10	+5VSB
11	D-
12	D+
13	GND
14	SSRX-
15	SSRX+
16	GND
17	SSTX-
18	SSTX+

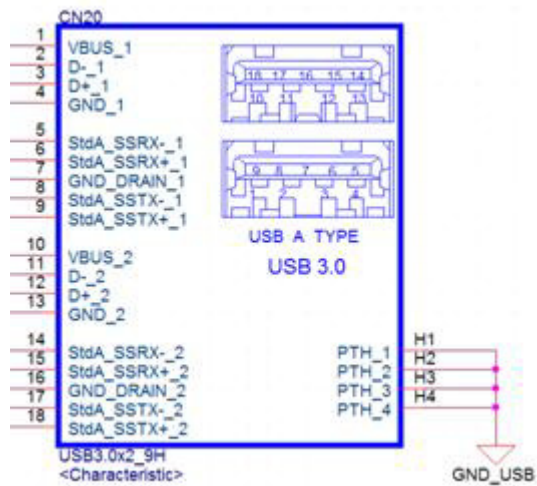
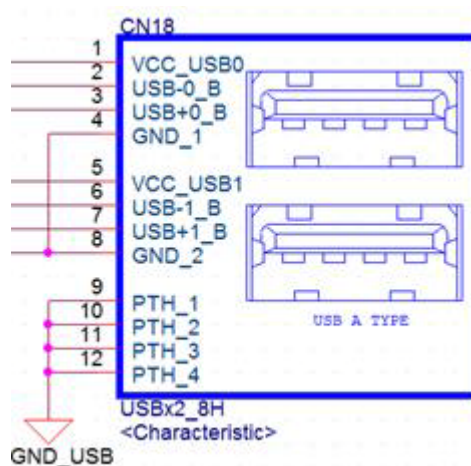


Table A.20: CN18: External USB

Part Number	1654009513
Footprint	USB_8P_UB1112C-8FDE-4F
Description	USB CONN. 8P 2.0mm 90D DIP UB1112C-8FDE-4F
Pin	Pin name
1	+5VSB
2	D-
3	D+
4	GND
5	+5VSB
6	D-
7	D+
8	GND

**Table A.21: CN23: RJ11**

Part Number	1652005977-02
Footprint	RJ11_6P_RJ1201-66N024R0
Description	PHONE JACK RJ11 6P6C 90D(F) DIP 6u RJ1201-66N024
Pin	Pin name
1	GND
2	GPIOA
3	Status
4	POWER
5	GPIOB
6	GND

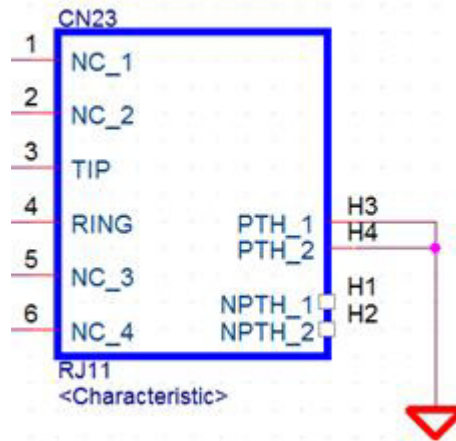


Table A.22: SW2 BUTTON: Power button

Part Number	1600000055
Footprint	SW_6P_TC003-N11AABRGXX-RK_D
Description	PUSH SW DIP 6P W/LED WO/Pb TC003-N11AABRGXX-RK
Pin	Pin name
1	GND
2	GND
3	ATX_PWRBTN#
4	ATX_PWRBTN#
5	+5V
6	GND

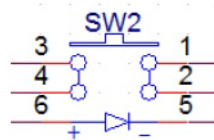


Table A.23: CN31: DC-IN

Part Number	1652005624
Footprint	PJ_2P_2DC-G213B200
Description	DC POWER JACK 2.5mm 90D(M) DIP 2DC-G213B200
Pin	Pin name
1	DC_IN
2	GND

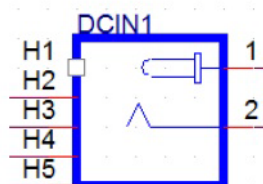
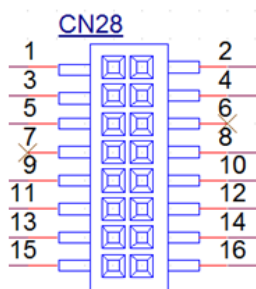


Table A.24: VGA	
Part Number	1653208260
Footprint	HD_8x2P_79_BOX
Description	BOX HEADER 8x2P 2.00mm 180D(M) SMD 23N6850
Pin	Pin name
1	VGA_R
2	+5V
3	VGA_G
4	GND
5	VGA_B
6	NC
7	NC
8	VGA_DDAT
9	GND
10	VGA_HS
11	GND
12	VGA_VS
13	GND
14	VGA_DCLK
15	GND
16	GND



ADVANTECH

Enabling an Intelligent Planet

www.advantech.com

Please verify specifications before quoting. This guide is intended for reference purposes only.

All product specifications are subject to change without notice.

No part of this publication may be reproduced in any form or by any means, electronic, photocopying, recording or otherwise, without prior written permission of the publisher.

All brand and product names are trademarks or registered trademarks of their respective companies.

© Advantech Co., Ltd. 2016