



Transportation

Product Catalog

for Passenger and Commercial Vehicles



ORIGINAL
EQUIPMENT
MANUFACTURER

littelfuse.com/CVP

Including:



Nearly 100 Years of Electrical Power Expertise

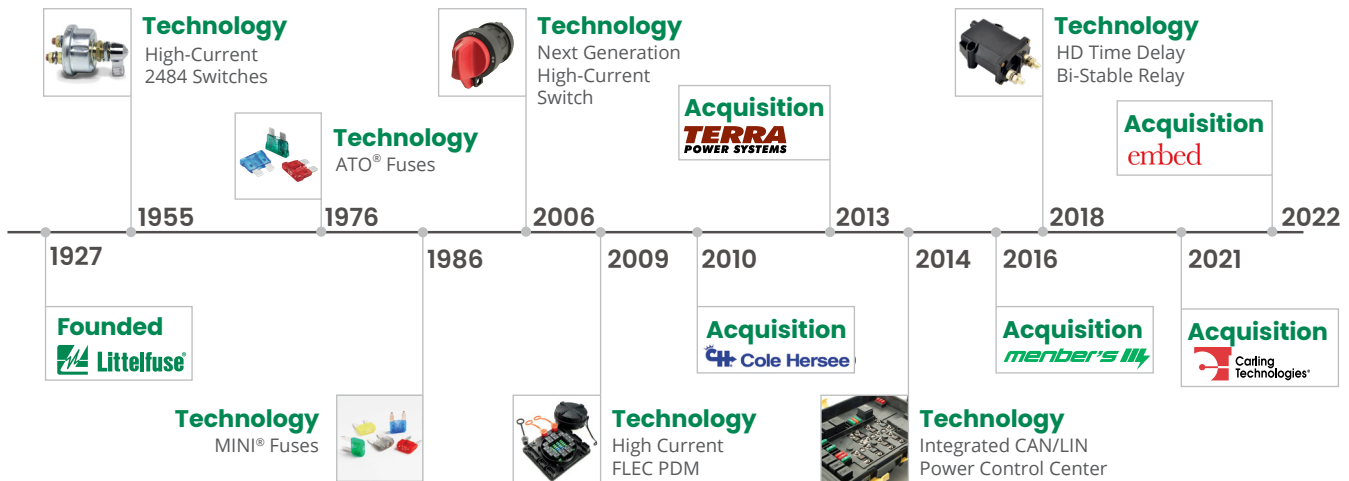

Market Focus Industries and Applications

Commercial Vehicle Focus Markets



Truck and Bus

- On-Highway
- Severe Duty
- Transit Buses
- Vocational



Construction

- Loaders
- Skid Steers
- Excavators
- Cranes



Agriculture

- Tractors
- Harvesters
- Lawn Turf
- Loaders



Material Handling

- Forklifts
- Telehandlers
- Aerial Work Platform
- Pallet Jacks



Powersport / Recreational

- Golf Carts
- ATV
- Snowmobiles

Other Served Markets



Marine

- Cabin Cruisers
- Ski Boats
- Pontoons
- Fishing Boats

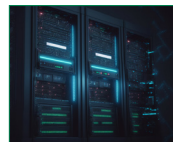

Datacom / Telecom

- Power Distribution Units
- Data Centers
- Cell Towers
- 5G Networks



Industrial Automation

- Conveyor Belts
- Motor Controllers
- Compressors
- Robotics



Renewable Energy

- Photovoltaic Systems
- Combiners Boxes
- Inverters



eMobility

- Battery Pack Disconnect
- HV Power Distribution
- Charging Station

AFTERMARKET PRODUCTS

Now Available

MCASE+® Cartridge Fuses



See [page 15](#) for more details.

FHZ Series Bolt-Down Fuse Blocks

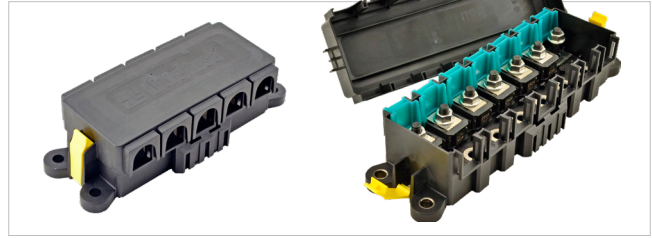

See [page 33](#) for more details.

Commercial and Fleet Vehicle Emergency Fuse Kit



See [page 23](#) for more details.

4P-5P Series ZCASE® Fuse Holder



See [page 40](#) for more details.

Red Box™ Blade Fuse Module Tray



See [page 25](#) for more details.

75930 and 75940 Series Manual Battery Disconnect Switches



See [page 68](#) for more details.



OEM Product

Now Available in Aftermarket Packaging

Rockers, Toggles and Push Button Switches,
USB Chargers, and Thermal Circuit Breakers

See [pages 136-138](#) for more details.



Table of Contents

Circuit Protection

Fuses and Circuit Breakers



Fuse Selection Chart	7
Fuseology	9
Packaging	11
Blade Fuses	12
Cartridge Fuses	15
Bolt-Down Fuses	16
Auto Link Fuses	17
Glass Fuses	18
Specialty Fuse Products	20
Assortment Kits	21
Circuit Breakers	27

Fuse Blocks & Holders



Bolt-Down Fuse Blocks	32
In-Line Fuse Holders	34
JCASE and Glass Fuse Holders	37
Add-A-Circuit® and Power Feed	38
Fuse Pullers and Battery Accessories	39
Multiple Position Fuse Blocks	39
Terminal Blocks	42
New Products Spotlight	44

Power Distribution Modules



Hard-Wired Boxes	46
Power Distribution Modules	47

Battery Management



Battery Isolators	52
Battery Combiners & FlexMod™ Devices	53
Low Voltage Disconnect Accessories	53
How A Smart Battery Isolator Works	54

Relays and Solenoids



Bi-Stable Latching Relays	56
Standard High Current Relays	57
Reversing and Latching Solenoids	60
Plug-In Relays	61
DC Contactor Selection Guide	63

Battery & Master Disconnect Switches



Battery Disconnect Switches	68
Single-Pole Battery Switches	73
Double-Pole Battery Switches	74
Marine Battery Switches	75
Battery Selector Disconnect Switches	76
Battery Switch & Battery Accessories	77
Application and Advantages	78
Principles of Operation and Selection Criteria	78
Battery Disconnect Switch Selection	79
Ingress Protection	80

Ignition Switches



Sealed Ignition Switches	82
Heavy Duty Ignition Switches	83
General Purpose Ignition Switches	84
Marine Grade Ignition Switches	86
Ignition Switch Accessories	87
Anti-Restart Ignition Switches	88

Rocker Switches



Sealed Rocker Switches	90
Rocker Switches and Accessories	94
Standard Heavy Duty Rocker Switches	95
FAQ's Rocker and Toggle Switches	96

Toggle Switches



Toggle Switches	98
Toggle Switches and Accessories	102
Switch Diagrams	103

Momentary Switches



Momentary Push-Button Switches	106
Momentary Door Switches	109

Push-Pull, Rotary and Foot Switches



Push-Pull Switches	112
Rotary Switches	114
Rotary Wiper Switches	115
Rotary Headlamp Switches	117
Foot Operated Switches	117
Specialty Switches	119

Vehicle Connectors



Tractor-Trailer Connectors	122
Trailer Connectors	127
Connector Mounts & Accessories	128

Indicator Devices



LED Pilot Lights	130
Incandescent Pilot Lights	131
Panel Lamps and Base Sockets	132
Buzzers and Alarms	133
Why Are LED Lights Better For My Vehicle?	134

New Packaged Carling Technologies Product



New Retail Packaged Product Offerings	136
Additional Product Capabilities	139

Appendix

Alphanumeric Part Number Index	141
--------------------------------	-----

Circuit Protection



What Type of Fuse do I Need?

DC automotive fuses are offered in three basic forms: Blade, Cartridge and Bolt Down.

Blade & Cartridge fuses can be hand inserted into a fuse holder. These fuses provide protection for several amperage ratings up to 80A. They are well suited to protect smaller to medium diameter wires that are usually some distance from the battery. Single blade fuse holders are often called 'In-Line' fuse holders as they are spliced into the wiring. Remember to place the fuse holder as close to the battery and as far away from the load as possible, so that it protects the wire from a short anywhere along its length. Any short between the power source and the fuse is not protected. Littelfuse blade fuses include: MICRO2®, MICRO3®, MINI®, LP MINI®, ATO®, MAXI®, MAXI+®, MCASE+®, JCASE® and LP JCASE®.

Bolt Down fuses need to be secured to the fuse holder with a screw, nut or bolt. These fuses provide protection from 30A to 600A. They are well suited to protect medium to large diameter wires that are usually closer to the battery. Ring terminals are crimped onto cables that are connected to these holders and spliced into the wiring. Remember to place the fuse holder as close to the battery and as far away from the load as possible, so that it protects the wire from a short anywhere along its length. Any short between the power source and the fuse is not protected which is why you should have master fusing as close the battery as possible. Littelfuse bolt-down fuses include: MIDI®, MEGA®, CF8 and ZCASE®.

Also, there are still a wide variety of applications that use glass tube fuses. These are typically lower current values and are becoming less popular for most automotive applications due to their size, form factors, and lack of color coding.

It Glows When it Blows!



SmartGlow® fuse technology makes identifying an open circuit quick and easy. Inside a fuse box, it can be difficult to locate which fuse in an array has blown. You can easily identify the SmartGlow because it lights up, indicating the need for replacement. Available in MINI®, ATO®, and MAXI® blade fuses.

Every Fuse Requires a Fuse Holder!

Littelfuse offers a wide variety of fuse holder and power distribution modules in different configurations to meet unique needs. Please see the Power Distribution Modules or Fuse Blocks & Holders sections of the catalog to select a product that fits your application requirements.



Retail Information



Planogram

Updated brand packaging introduced in 2015 allowing for easy identification of product families in a retail display.

Littelfuse developed the next generation of Retail Circuit Protection with the ease of product selection as a top priority.

Easy Identification

Of product families in color coordinated packages for an easy to use and set up planogram layout.

More Space

For higher margin kits and assortments.

Increase Market Coverage

With the newest Littelfuse MICRO2®, MICRO3®, MCASE+® and ZCASE® fuses.

**ORIGINAL
EQUIPMENT
MANUFACTURER**

OEM Symbol

Prominent on package assures consumers of quality and actual OE replacement.

Color Coded

For easier stocking and consumer selection.

Multi-Lingual

One SKU covers US, Canadian, German and Latin American markets.

MATERIAL NUMBER	CATALOG NUMBER	DESCRIPTION
00940477Z	094477	Our 87 SKU, 510-piece pre-pack Plan-O-Gram includes full blade-fuse coverage, as well as expanded coverage into newer parts such as Low-Profile MINI, Low-Profile JCASE, MICRO2, MICRO3, MCASE and Emergency Kits. Includes blade fuses, glass fuses, circuit breakers, Assortment and Emergency kits, fuse holders and fuse tester/pullers. Measures approximately 36"x36".

Fuse Selection Chart

FUSE TYPE	MICRO2	ATO®	MINI®	MCASE® + JCASE®	MAXI	MIDI	MEGA®	PAL Series 0	PAL Series 1	PAL Series 2	PAL Series 5	ZCASE
ACTUAL FUSE SIZE	MICRO3		Low Profile MINI®	Low Profile JCASE®	MAXI +			Female Terminal PAL Series 3 Mini Female Terminal	Straight Male Terminal	13/16" Bent Male Terminal PAL Series 4 9/16" Bent Male Terminal	Locking Female Terminal	
Black		1A				175A			80A	80A		40A
Gray		2A		15A	25A	150A			120A	120A		60A
Violet		3A	3A		100A	200A			140A	140A		80A
Pink		4A	4A	30A		125A	250A	30A	30A	30A		100A
Tan		5A	5A	25A	70A	70A	225A					125A
Brown		7.5A	7.5A	35A						70A	25A	150A
Red		10A	10A	50A	50A	50A	80A	50A	50A	50A		175A
Blue		15A	15A	20A	60A	100A	200A	20A	100A	100A		200A
Yellow		20A	20A	60A	20A	60A	100A	60A	60A	60A		225A
Clear		25A	25A	80A	80A	80A						250A
Green		30A	30A	40A	30A	40A	125A	40A		40A	30A	300A
Orange		40A		40A	40A	30A	150A					400A
White				25A		25A	175A			120A		500A
Light Green					30A	30A						600A

GLASS

AGU	AGY	SFE30
AGC	SFE20, UK	AGX
SFE14	AGW, SFE75, SFE9	AGA, SFE4
SFE6		

AGA	1A	1.5A	2A	3A	5A	6A	7.5A	10A	15A	20A	25A	30A
AGC	1.5A	2A	2.5A	3A	4A	5A	6A	7.5A	10A	15A	20A	25A
AGU	1A	1.5A	2A	3A	4A	5A	6A	7.5A	10A	15A	20A	25A
AGY	1A	1.5A	2A	3A	4A	5A	6A	7.5A	10A	15A	20A	25A
AGW	1A	1.5A	2A	3A	4A	5A	6A	7.5A	10A	15A	20A	25A
AGX	1A	1.5A	2A	3A	4A	5A	6A	7.5A	10A	15A	20A	25A
UK	3A	4A	5A	6A	7.5A	10A	15A	20A	25A	30A	35A	50A

Fuse Holder Selection Chart

FUSE TYPE	ATO®		MINI®		MAXI		GLASS							
ACTUAL FUSE SIZE														
PHOTO														
Series Name	FHAC1	FHAC2	FHA1	FHA2	FHA-GLO	AFH1	SEALD ATO	FHM1	FHM2	FHM-GLO	SEALED MINI	MAH1	FNY1	FNY2
Holder Type	In-Line	In-Line	In-Line	In-Line	In-Line	In-Line Panel Mount	In-Line	In-Line	In-Line	In-Line	In-Line	In-Line	In-Line	In-Line
Max Amperage	20A	30A	20A	30A	30A	30A	30A	20A	30A	30A	30A	60A	20A	30A
Wire Color	Black	Orange	Black	Orange	Red	Black	Red	Black	Orange	Red	Red	Black or Red	Black	Orange
Weatherproof	•	•			•		•	•	•	•	•		•	•
Notes	Standard	Heavy Duty	Standard	Heavy Duty	Heavy Duty	Standard	Heavy Duty	Standard	Heavy Duty	Heavy Duty	Heavy Duty	Standard	Standard	Heavy Duty
FUSE TYPE	JCASE® and Low Profile JCASE®													
ACTUAL FUSE SIZE														
PHOTO														
Series Name	FHJC1	FHJC2	FHJ1	FHJ2	498	Compact-498	FLEX-MIDI	298	SN	FLEX-MEGA				
Holder Type	In-Line	In-Line	In-Line	In-Line	In-Line	In-Line	Bolt-Down	Bolt-Down	Bolt-Down	Bolt-Down				
Max Amperage	40A	60A	40A	60A	200A	200A	200A	500A	500A	500A				
Wire Color	Red	Red	Red	Red	-	-	-	-	-	-				
Weatherproof	•	•				with heat shrink								
Notes	Standard	Heavy Duty	Standard	Heavy Duty	Standard	Compact	Busbars Available	Standard	AssureLatch & IP69K	Busbars Available				

AA-101-CFSC

Fuseology

Understanding how circuit protection works is a key to diagnosing automotive electrical problems. When a fuse blows, that means the fuse is doing its job — sending you a message that something needs to be fixed.

What is the purpose of a fuse?

A fuse is a safety valve. It is designed to stop current from exceeding the rating of the wires or components. Without fuses, excessive current could cause damage to electrical systems, and even result in fires.

In general, a fuse has a simple construction. The key component is the “element” — a short piece of metal wire or strap.

What causes a fuse to blow?

The element is designed to melt at a specific temperature, to protect wires and equipment from overcurrents. An overcurrent is any current that exceeds the amperage rating or wiring capacity of equipment or devices under normal conditions of use.



If an overcurrent causes the current in a circuit to rise above a specific level — often the circuit’s rating — the heat produced will melt the fuse’s element, causing the fuse to “blow.” This opens the circuit and immediately stops the flow of current. Fuses are designed to blow at temperatures far below those that would cause damage or hazards.

Once a fuse is blown, it can be replaced to allow the current to flow again. **But simply replacing a fuse may not be the solution to the problem.** In fact, there is a chance the fuse will just blow again, because the fuse is signaling a problem in the system. Understanding the factors that cause a fuse to blow will help you diagnose automotive electrical problems.

There are two types of overcurrents that can cause a fuse to blow: overloads and short circuits.

Overload

What: The current exceeds the amperage at which the wires or equipment are rated.

Why: Too many devices are connected to one circuit, or a device malfunctions and draws higher than its normal operating current. Sustained overloads cause overheating of circuit components and the fuse blows.

Short Circuit

What: The current is out of its normal path.

Why: A malfunction creates an unintended path for electricity to flow from the battery or alternator to ground. This can be caused by the touching of any positive wire to a ground wire, e.g. due to frayed wire insulation, or tools laid across the positive and ground wires of a circuit. The uncontrolled current to ground then surpasses the normal resistance of the wire contained in the circuit, forcing higher and higher current to the point that the generating heat blows the fuse.

Finding a Fuse

To be able to address fuse issues, you first must be able to locate the appropriate fuse within the vehicle. In today’s vehicles, each individual wire is protected by a circuit protection device.

Fuses are contained in fuse blocks located at various points throughout the vehicle. The diagram above illustrates typical fuse block locations.

Selecting the Right Fuse

Once you have found the fuse that has blown, and solved the problem in the vehicle, you must replace the blown fuse with an appropriate device.

When selecting the right fuse for replacement, you should consider the following:

Physical Type

The replacement fuse must be of the same physical type as the blown fuse being replaced. It must be of the same style and have the same dimensions so that it can fit properly in the fuse block or fuse holder. Check your owner’s manual to determine the appropriate fuse type.

Installation Tip: Littelfuse holds patents for the designs on most automotive fuses. It is important to remember that the physical type of the fuse is important, but it is not the only factor affecting the fuse’s function. Although some fuses appear to be the same type and dimension as Littelfuse fuses, they do not necessarily have the same performance characteristics.



Look for the Littelfuse OEM Label

To guarantee the same level of quality in circuit protection that the major automotive manufacturers require for their original equipment fuses, look for the OEM seal on Littelfuse aftermarket products. Only Littelfuse products can guarantee this level of quality.

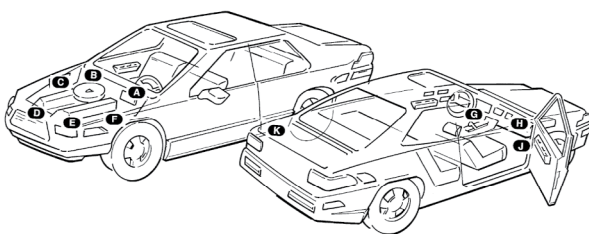

Bold letter indicates fuse block location.

- | | |
|--------------------------|--|
| A Left fire wall | G Behind/under dash left |
| B Right fire wall | H Behind/in glove box |
| C Right fender | J Behind/under dash right |
| D Right front | K Rear compartment |
| E Left front | IL In-line with device protected |
| F Left fender | (locations may vary from car to car, see your dealer.) |

Fuseology

Beware of Counterfeit Fuses

At first glance, it's hard to tell the difference between a genuine Littelfuse blade fuse and a counterfeit. The counterfeit may have the same physical dimensions, but using it can be dangerous because it fails to perform to the stringent performance and safety specifications developed by Littelfuse and the OEMs.

In many cases, the elements in counterfeit fuses do not correspond with the amperage specification stamped on the fuse. This will prevent the elements from opening at the rated or correct amperage, which could result in a fire causing serious damage to the vehicle, its contents and its passengers.

Responding to this growing problem, the United States International Trade Commission and then President Ronald Reagan issued and approved an exclusion order in 1983 prohibiting the importation of the look-alike blade fuses into the United States. This order was initiated because many of these fuses were proven to be totally unsafe. The photos shown here indicate why counterfeit fuses are potentially unsafe and present a fire risk.

To guarantee quality and safety, look for the Littelfuse name on fuses and fuse packaging.



Current Rating — Amperage

The current rating, marked on every fuse, is the maximum current in amperes that the fuse can continuously carry under specified conditions.

Tip: When selecting a fuse, make sure the current rating of the fuse is the same amperage as the circuit. You can obtain the

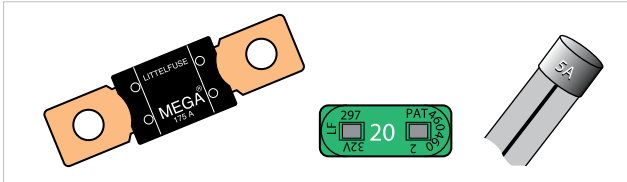

current rating of a circuit by looking in the owner's manual of the vehicle or checking to see if it is written on the fuse block.

Overfusing and Underfusing

Overfusing is when the fuse has a current rating higher than the rating of the circuit. In this case, the fuse will not be able to protect the circuit properly because the circuit could reach overcurrent levels, causing damage and safety hazards, before the fuse would blow.

Underfusing is when the fuse is rated at a current too far below the rating of the circuit. In this case the fuse will blow, even though the circuit is functioning normally without an overcurrent. Underfusing almost guarantees that a fuse will blow repeatedly. This is referred to as a nuisance blow.

Voltage Rating

The voltage rating, marked on every fuse, indicates the maximum voltage at which the fuse is designed to operate safely if an overcurrent occurs.

Tip: The fuse voltage rating must equal or exceed this circuit voltage where the fuse is installed. This is not a problem in fuse selection because automotive fuse applications are typically around 12 volts, while the voltage rating of the majority of Littelfuse automotive fuses including ATO Fuse, MINI Fuse, MAXI Fuse and MEGA Fuse is 32 volts.

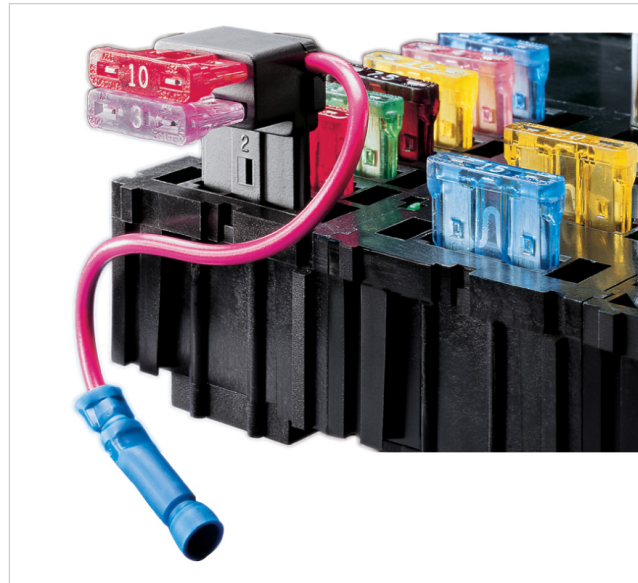

Adding a Circuit

Always use a circuit protection device with a fuse holder or fuse block whenever adding additional circuits to ensure optimal safety. The fastest, easiest option for installers who need to add a circuit for applications such as electronic components, is the Littelfuse Add-A-Circuit Fuse Holder. Add-A-Circuit, available in ATO® and MINI® blade fuse versions, is designed to facilitate installation of fuses for accessories of 10 amps or less. The Add-A-Circuit adapts the fuse block to the installer's needs, quickly turning one slot in the fuse block into two, providing a safe, economical alternative to splicing or fusetaps.

Caution: Fusetaps are not a recommended alternative for adding circuits because they can overstress the terminals in the fuse block. This situation can create a loose fitting fuse, which in turn produces excessive heat, which can cause nuisance blows, even melting of the fuse and fuse block and possibly an expensive repair in the future. When a fusetap is used, in many cases there is no fuse protecting the new circuit, a condition which can also present a hazard.



Another alternative to adding a circuit is the Littelfuse Battery Power Feed (BPF). This device attaches directly to the battery terminal, allowing the addition of up to three circuits. Then use an in-line fuse holder to protect the circuit properly.

Packaging

Packaging / Part Numbering



Bulk Carton

The outer corrugated cardboard box that holds several cartons.

Carton

The outer corrugated cardboard box that holds several inner packs, or bulk fuses (no inner packs).

Blister Pack

A retail package containing one or several identical products, such as fuses, or it may contain an assortment of fuses. Blister packs are designed to fit on a peg-hook. 'Bubble pack' or 'clamshell' packages are blister packs.

Inner Pack

A small chipboard box containing several blister packs or pillboxes.

Pill Box

A small plastic box containing fuses. Pillboxes are snap-shut resealable.

Standard Fuse Packaging

BOXED MERCHANDISE	PIECES/ BOX	STANDARD PACK	ORDER
ATO, MINI Fuses	5 to a box	100 (twenty 5 packs)	by piece
Glass Ceramic Fuses	5 to a box	50 (ten 5 packs)	by piece
AGU Fuses	10 to a box	10 (one 10 pack)	by piece
MAXI, PAL, MEGA, MIDI	1 to a pack	10	by piece
Flashers, Circuit Breakers, Fuse Holders	1 to a pack	10	by piece

RETAIL PACKAGED MERCHANDISE	FUSES/ CARD	STANDARD PACK	ORDER
ATO, MINI Fuses, Glass, Ceramic Fuses	5 to a card	5 cards/shelf pack	by card
MAXI, PAL, MEGA, MIDI Fuses Plus Packs	1 to a card	5 cards/shelf pack	by card
Retail Carded Kits and Assortments	Various	5 cards/shelf pack	by card
Assortments, Jobber Boards, Merchandisers, etc.	Various	Single unit	by card

Examples of Order Numbers

Order numbers must have between 9 characters and 15 characters. These are for added description, such as ZXPRO. When you place an order, write or type the characters without a break in the string.

0 A T 0 0 1 0 . V P
 First set of four "ATO Fuses" Second set of four "10 Amps:" "Retail pack of 5"

0 M I N 0 3 0 . Z X P R O
 First set of four "MINI Fuses" Second set of four "30 Amps:" "Professional Pack"

Mandatory Characters

First set of four

These identify the product group, like LMIN (Low profile MINI fuse) or 0MAX (MAXI fuses).

Second set of four

These identify the product subgroup. In fuses, this usually identifies the amperage.

The decimal point counts as one character, eg 010. = 10A, 100. = 100A, 01.5 = 1.5A.

9th character

Inner pack quantity. See list of codes below.

Inner Pack Codes

Quantity Code

1 = X	50 = L	500 = U	3,000 = W
5 = V	100 = H	1,000 = M	4,000 = Y
10 = T	200 = F	1,500 = D	5,000 = N
20 = S	250 = G	2,500 = E	10,000 = K

Optional Characters

10th Character

Packaging type. P= Retail pack, B=Blister Pack.

Last set of 5

May be used to give additional information such as, MXGLO for SmartGlow fuses

Blade Fuses

MINI® • 2-30A

The MINI fuse is quickly becoming the new standard for vehicle circuit protection. Its miniature design meets the need for more circuits to be protected while utilizing less space, and its ability to cope with high temperatures in adverse environments makes the MINI fuse the recommended choice for protection. Smart Glow fuses are innovative automotive style fuses that feature an indicator light that glows when the fuse is blown, saving time to troubleshoot an open circuit.



Additional information: Littelfuse.com/MINI, Littelfuse.com/MINISmartGlow

Standard: Voltage Rating Characteristics: 32V AC/DC Fast-Acting, Approvals: UL listed, SAE J2077.

Smart Glow: Interrupting Rating: 1000A @ 32V DC, Voltage Rating: 32V DC, Operating Temperature Range: -40°C to +125°C, Terminals: Tin plated zinc



COLOR CODE	CURRENT RATING (A)	BOXED MATERIAL NUMBER	CARDED PACKAGING MATERIAL NUMBER	CARDED PRO 25 PIECE MATERIAL NUMBER	CARDED PACKAGING MATERIAL NUMBER
Gray	2	0MIN002.V	0MIN002.VP	0MIN002.ZXPRO	-
Violet	3	0MIN003.V	0MIN003.VP	0MIN003.ZXPRO	0MIN003.VPGLO
Pink	4	0MIN004.V	0MIN004.VP	0MIN004.ZXPRO	-
Tan	5	0MIN005.V	0MIN005.VP	0MIN005.ZXPRO	0MIN005.VPGLO
Brown	7.5	0MIN07.5V	0MIN07.5VP	0MIN07.ZXPRO	0MIN07.5VPGLO
Red	10	0MIN010.V	0MIN010.VP	0MIN010.ZXPRO	0MIN010.VPGLO
Blue	15	0MIN015.V	0MIN015.VP	0MIN015.ZXPRO	0MIN015.VPGLO
Yellow	20	0MIN020.V	0MIN020.VP	0MIN020.ZXPRO	0MIN020.VPGLO
Clear	25	0MIN025.V	0MIN025.VP	0MIN025.ZXPRO	0MIN025.VPGLO
Green	30	0MIN030.V	0MIN030.VP	0MIN030.ZXPRO	0MIN030.VPGLO



Dimensions [mm]

MINI®

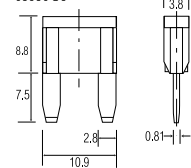

Smart Glow MINI®

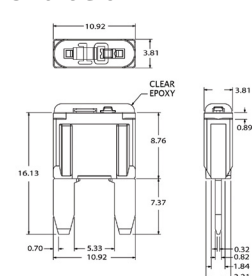

Low Profile MINI® • 2-30A

The Low Profile MINI fuse is designed to mate with tuning-fork terminals, which provides additional weight and material savings in fuse box designs by eliminating the need for female box terminals.

Additional information: Littelfuse.com/LPMINI

Voltage Rating: 58V DC, Interrupting Rating: 1000A @ 58V DC, Operating Temperature Range: -40°C to +125°C, Terminals: Silver plated zinc, Housing Materials: Nylon composite



COLOR CODE	CURRENT RATING (A)	BOXED MATERIAL NUMBER	CARDED PACKAGING MATERIAL NUMBER	CARDED PLUS PACK PACKAGING MATERIAL NUMBER
Gray	2	LMIN002.V	-	-
Tan	5	LMIN005.V	LMIN005.VP	LMIN005.ZXPROA
Brown	7.5	LMIN07.5V	-	-
Red	10	LMIN010.V	LMIN010.VP	LMIN010.ZXPROA
Blue	15	LMIN015.V	LMIN015.VP	LMIN015.ZXPROA
Yellow	20	LMIN020.V	LMIN020.VP	LMIN020.ZXPROA
Clear	25	LMIN025.V	LMIN025.VP	LMIN025.ZXPROA
Green	30	LMIN030.V	LMIN030.VP	LMIN030.ZXPROA



Dimensions [mm]

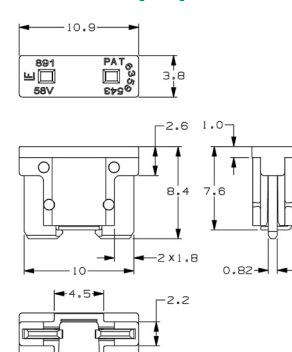

Blade Fuses

ATO® • Autofuse® • 1-40A

The ATO fuse is currently found on most cars, trucks, buses and off the road vehicles worldwide. Features Littelfuse designed industry standard color coding to indicate amp rating. Smart Glow fuses are innovative automotive style fuses that feature an indicator light that glows when the fuse is blown, saving time to troubleshoot an open circuit.

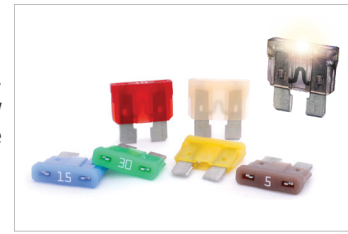

Additional information: Littelfuse.com/ATOSmartGlow, Littelfuse.com/Blade-Fuses/ATO

Standard: Voltage Rating Characteristics: 32V AC/DC Fast-Acting Approvals: UL listed, SAE J2077.

Smart Glow: Interrupting Rating: 1000A @ 32V DC Voltage Rating: 32V DC Operating Temperature Range: -40°C to +125°C Terminals: Tin plated zinc



COLOR CODE	CURRENT RATING (A)	BOXED MATERIAL NUMBER	CARDED PACKAGING MATERIAL NUMBER	CARDED PLUS PACK PACKAGING MATERIAL NUMBER	CARDED PACKAGING MATERIAL NUMBER
Black	1	0ATO001.V	0ATO001.VP	-	-
Gray	2	0ATO002.V	0ATO002.VP	-	-
Violet	3	0ATO003.V	0ATO003.VP	-	0ATO003.VPGLO
Pink	4	0ATO004.V	0ATO004.VP	-	-
Tan	5	0ATO005.V	0ATO005.VP	0ATO005.ZXPRO	0ATO005.VPGLO
Brown	7.5	0ATO007.5V	0ATO007.5VP	0ATO007.5ZXPRO	0ATO007.5VPGLO
Red	10	0ATO010.V	0ATO010.VP	0ATO010.ZXPRO	0ATO010.VPGLO
Blue	15	0ATO015.V	0ATO015.VP	0ATO015.ZXPRO	0ATO015.VPGLO
Yellow	20	0ATO020.V	0ATO020.VP	0ATO020.ZXPRO	0ATO020.VPGLO
Clear	25	0ATO025.V	0ATO025.VP	0ATO025.ZXPRO	0ATO025.VPGLO
Green	30	0ATO030.V	0ATO030.VP	0ATO030.ZXPRO	0ATO030.VPGLO
Orange	40	0ATO040.V	0ATO040.VP	-	-



Dimensions inches [mm]

ATO®

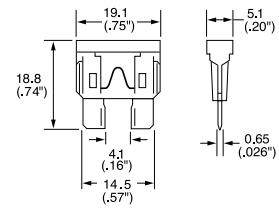

Smart Glow ATO®

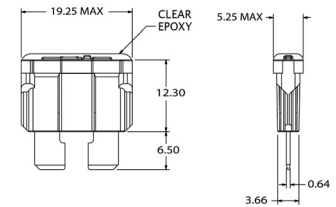

MAXI • 20-100A

MAXI Fuses are primarily used for under hood applications and are produced with a high temperature polymer and silver plated blades. They replace the commonly used fusible wire or fusible link to protect a high current segment or system of the wiring harness. Features Littelfuse designed industry standard color coding to indicate amp rating. Smart Glow fuses are innovative automotive style fuses that feature an indicator light that glows when the fuse is blown, saving time to troubleshoot an open circuit.



Additional information: Littelfuse.com/MAXI, Littelfuse.com/MAXISmartGlow

Standard: Voltage Rating: 32V DC, Interrupting Ratings: 1000A @ 32V DC, Operating Temperature Range: -40°C to +125°C, Terminals: Silver plated

Smart Glow: Voltage Rating: 32V DC, Interrupting Ratings: 1000A @ 32V DC, Operating Temperature Range: -40°C to +125°C, Terminals: Silver plated



COLOR CODE	CURRENT RATING (A)	BOXED MATERIAL NUMBER	CARDED PACKAGING MATERIAL NUMBER	CARDED PACKAGING MATERIAL NUMBER
Yellow	20	0MAX020.X	0MAX020.XP	0MAX020.XPGLO
Green	30	0MAX030.X	0MAX030.XP	0MAX030.XPGLO
Orange	40	0MAX040.X	0MAX040.XP	0MAX040.XPGLO
Red	50	0MAX050.X	0MAX050.XP	0MAX050.XPGLO
Blue	60	0MAX060.X	0MAX060.XP	0MAX060.XPGLO
Tan	70	0MAX070.X	-	0MAX070.XPGLO
Clear	80	0MAX080.X	0MAX080.XP	0MAX080.XPGLO
Purple	100	-	-	0MAX100.XPGLO



Dimensions inches [mm]

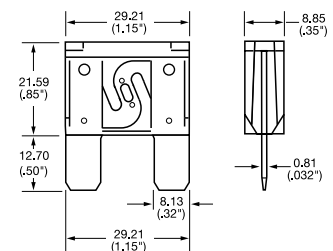

Blade Fuses

MAXI+® • 20-60A **NEW**

The MAXI+® Fuse is new standard for vehicle circuit protection. Its miniature design meets the need for more circuits to be protected while utilizing less space, and its ability to cope with high temperatures in adverse environments makes the MAXI+® Fuse of recommended choice for protection.

Additional information: Littelfuse.com/MAXI32V

Voltage Rating: 32V DC, Interrupting Ratings: 1000A @ 32V DC, Operating Temperature Range: -40°C to +125°C



COLOR CODE	CURRENT RATING (A)	BULK MATERIAL NUMBER	CARDED 2 PIECE MATERIAL NUMBER	TEST CABLE SIZE (MM²)	TYP. VOLTAGE DROP (MV)	TYP. COLD RESISTANCE (MO)
Yellow	20	0899020.Z	0MAXP020.VP	1.5	80	3.0
White	25	0899025.Z	0MAXP025.VP	2.5	77	2.3
Light Green	30	0899030.Z	0MAXP030.VP	2.5	60	1.7
Dark Green	35	0899035.Z	0MAXP035.VP	4	58	1.2
Orange	40	0899040.Z	0MAXP040.VP	4	55	1.0
Red	50	0899050.Z	0MAXP050.VP	6	50	0.7
Blue	60	0899060.Z	0MAXP060.VP	6	62	0.5

Dimensions [mm]

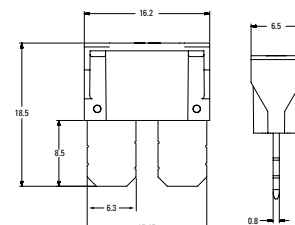

MICRO2® • 5-30A

Its sub-miniature design meets the need for more circuits to be protected while utilizing less space and its ability to cope with high temperatures in adverse environments makes the MICRO2 Fuse the recommended choice for protection.

Additional information: Littelfuse.com/MICRO2

Voltage Rating: 32V DC, Interrupting Ratings: 1000A @ 32V DC, Operating Temperature Range: -40°C to +125°C



COLOR CODE	CURRENT RATING (A)	BULK 50 PIECE MATERIAL NUMBER	CARDED PLUS 25 PIECE MATERIAL NUMBER	BOXED 5 PIECE MATERIAL NUMBER	CARDED 5 PIECE MATERIAL NUMBER
Tan	5	0327005.LXS	-	MIC2005.V	MIC2005.VP
Brown	7.5	032707.5LXS	-	MIC207.5V	MIC207.5VP
Red	10	0327010.LXS	MIC2010.ZXPRO	MIC2010.V	MIC2010.VP
Blue	15	0327015.LXS	MIC2015.ZXPRO	MIC2015.V	MIC2015.VP
Yellow	20	0327020.LXS	MIC2020.ZXPRO	MIC2020.V	MIC2020.VP
Clear	25	0327025.LXS	-	MIC2025.V	MIC2025.VP
Green	30	0327030.LXS	MIC2030.ZXPRO	MIC2030.V	MIC2030.VP



Dimensions [mm]

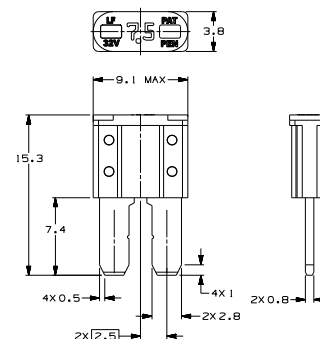

MICRO3® • 5-15A

The MICRO3 Fuse is the new standard for vehicle circuit protection. The MICRO3 Fuse has 3 terminals and 2 fuse elements with a common center terminal. Its sub-miniature design meets the need for more circuits to be protected while utilizing less space and its ability to cope with high temperatures in adverse environments makes the MICRO3 Fuse the recommended choice for protection.

Additional information: Littelfuse.com/MICRO3

Voltage Rating: 32V DC, Interrupting Ratings: 1000A @ 32V DC, Operating Temperature Range: -40°C to +125°C



COLOR CODE	CURRENT RATING (A)	BOXED 50 PIECE MATERIAL NUMBER	CARDED PLUS 25 PIECE MATERIAL NUMBER	BOXED 5 PIECE MATERIAL NUMBER	CARDED 5 PIECE MATERIAL NUMBER
Tan	5	0337005.LXS	MIC3005.ZXPRO	MIC3005.V	MIC3005.VP
Brown	7.5	033707.5LXS	MIC307.5ZXPRO	MIC307.5V	MIC307.5VP
Red	10	0337010.LXS	MIC3010.ZXPRO	MIC3010.V	MIC3010.VP
Blue	15	0337015.LXS	MIC3015.ZXPRO	MIC3015.V	MIC3015.VP



Dimensions [mm]

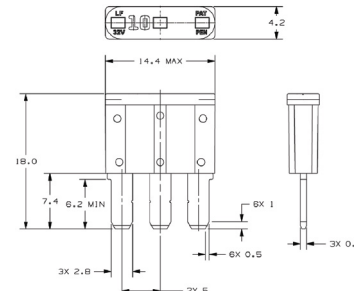

Cartridge Fuses

JCASE® • 20-60A

Smaller space saving footprint is being designed in by many OEM's. Patented technology provides both increased time delay and low voltage drop. Features ANSI standard OCR-A font for visual inspection systems, double spring-beam box terminal and unique secondary locking feature holds terminal firmly in place.

Additional information: Littelfuse.com/JCASE

Voltage Rating Characteristics: 32V AC/DC Slo-Blo®, Interrupting Ratings: 1000A @ 32V DC, Operating Temperature Range: -40°C to +125°C, Insertion Force: 53N max. (12lb), Extraction Force: 9N min. (2lb)



COLOR CODE	CURRENT RATING (A)	BOXED MATERIAL NUMBER	CARDED PACKAGING MATERIAL NUMBER
Blue	20	JCAS020.X	JCAS020.XP
White	25	JCAS025.X	JCAS025.XP
Pink	30	JCAS030.X	JCAS030.XP
Green	40	JCAS040.X	JCAS040.XP
Red	50	JCAS050.X	JCAS050.XP
Yellow	60	JCAS060.X	JCAS060.XP



Dimensions [mm]

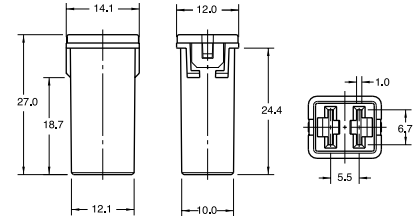

Low Profile JCASE® • 20-60A

Smaller space saving footprint is being designed in by many OEM's. Patented technology provides both increased time delay and low voltage drop. Features ANSI standard OCR-A font for visual inspection systems, double spring-beam box terminal and unique secondary locking feature holds terminal firmly in place.

Additional information: Littelfuse.com/LPJCASE

Voltage Rating: 58V DC, Interrupting Rating: 1000A @ 58V DC, Operating Temperature Range: -40°C to +125°C, Insertion Force: 53N Max. (12 lb.), Extraction Force: 9N Min (2 lb.)



COLOR CODE	CURRENT RATING (A)	BOXED MATERIAL NUMBER	CARDED PACKAGING MATERIAL NUMBER
Blue	20	LJCA020.X	LJCA020.XP
White	25	LJCA025.X	LJCA025.XPA
Pink	30	LJCA030.X	LJCA030.XP
Green	40	LJCA040.X	LJCA040.XP
Red	50	LJCA050.X	LJCA050.XP
Yellow	60	LJCA060.X	LJCA060.XP



Dimensions [mm]

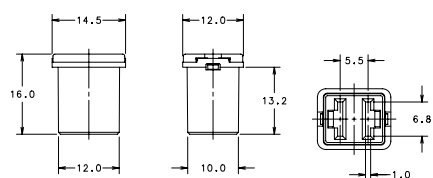

MCASE+® • 15-60A

The Unslotted MCASE+ Fuse is a cartridge style fuse up to 40A with female terminals for 2.8 mm male terminals. The Slotted MCASE+ Fuse is available up to 60A and can mate with larger male terminals (e.g., 6.3mm) or even mount directly to onto a busbar. Miniaturized footprint for optimal usage of space, featuring time delay and the ability to handle inrush currents.

Additional information: Littelfuse.com/MCASE

Voltage Rating: 32V DC, Interrupting Ratings: 1000A @ 32V DC, Operating Temperature Range: -40°C to +125°C, Fuse Insertion Force: 50N (11.2lbf) Typical, Extraction Force: 4N Min. (0.9 lb.) | 24.5N Max. (5.5 lb)



COLOR CODE	CURRENT RATING (A)	BULK 500 PIECE MATERIAL NUMBER	BOXED 50 PIECE MATERIAL NUMBER	BOXED 5 PIECE MATERIAL NUMBER	CARDED 1 PIECE MATERIAL NUMBER	CARDED 5 PIECE MATERIAL NUMBER
Unslotted MCASE+						
Gray	15	0695015.U	0695015.LPXP	MCAS015.V	MCAS015.XP	-
Blue	20	0695020.U	0695020.LPXP	MCAS020.V	MCAS020.XP	-
White	25	0695025.U	0695025.LPXP	MCAS025.V	MCAS025.XP	-
Pink	30	0695030.U	0695030.LPXP	MCAS030.V	MCAS030.XP	-
Green	40	0695040.U	0695040.LPXP	MCAS040.V	MCAS040.XP	-
Slotted MCASE+						
Gray	15	0695015.US	0695015.LPXP	MCAS015.VS	MCAS015.XPS	-
Blue	20	0695020.US	0695020.LPXP	MCAS020.VS	MCAS020.XPS	MCAS020.VPS
White	25	0695025.US	0695025.LPXP	MCAS025.VS	MCAS025.XPS	-
Pink	30	0695030.US	0695030.LPXP	MCAS030.VS	MCAS030.XPS	MCAS030.VPS
Green	40	0695040.US	0695040.LPXP	MCAS040.VS	MCAS040.XPS	MCAS040.VPS
Red	50	0695050.US	0695050.LPXP	MCAS050.VS	MCAS050.XPS	-
Yellow	60	0695060.US	0695060.LPXP	MCAS060.VS	MCAS060.XPS	-



Dimensions [mm]

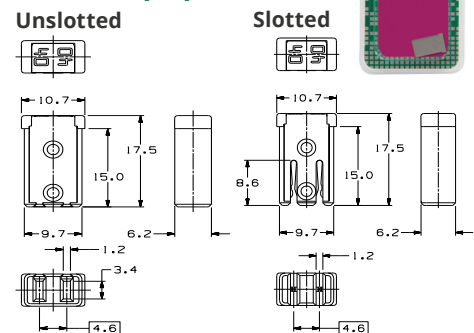

* Please inquire about additional bulk quantities

Bolt-Down Fuses

MEGA® • 80-500A

Littelfuse patented fuse designed for high current protection up to 500A found on many OEM vehicles. Slo-Blo® feature eliminates nuisance blowing during temporary, short duration overloads. Commonly used for battery and alternator connections and other heavy gauge cables requiring ultra high current protection. Also available with a clear housing, M6 mounting hole, single mounting hole or silver plating. **Additional information:** Littelfuse.com/MEGA



Voltage Rating Characteristics: 32V AC/DC, Slo-Blo®

CURRENT RATING (A)	BOXED 50 PIECE MATERIAL NUMBER	BOXED 50 PIECE MATERIAL NUMBER	CARDED MATERIAL NUMBER
80	-	OMEG080.X	OMEG080.XPA
100	OMEG100.L	OMEG100.X	OMEG100.XP
125	OMEG125.L	OMEG125.X	OMEG125.XP
150	OMEG150.L	OMEG150.X	OMEG150.XP
175	OMEG175.L	OMEG175.X	OMEG175.XP
200	OMEG200.L	OMEG200.X	OMEG200.XP
225	OMEG225.L	OMEG225.X	OMEG225.XP
250	OMEG250.L	OMEG250.X	OMEG250.XP
300	OMEG300.L	OMEG300.X	-
350	OMEG350.L	OMEG350.X	-
400	OMEG400.L	OMEG400.X	-
450	OMEG450.L	OMEG450.X	-
500	OMEG500.L	OMEG500.X	-



Dimensions inches [mm]

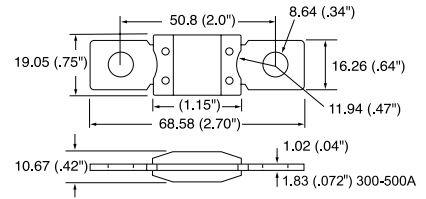

MIDI® • 30-200A

Littelfuse patented fuse found on many OEM vehicles. Slo-Blo® feature eliminates nuisance blowing during temporary, short duration overloads. Also available with a clear housing, M6 mounting hole, single mounting hole or silver plating. **Additional information:** Littelfuse.com/MIDI

Voltage Rating Characteristics: 32V AC/DC, Slo-Blo®

CURRENT RATING (A)	BULK 10 PIECE MATERIAL NUMBER	BOXED MATERIAL NUMBER	CARDED MATERIAL NUMBER
30	0498030.TXN	-	-
40	0498040.TXN	-	-
50	0498050.TXN	0MID050.X	0MID050.XP
60	0498060.TXN	-	-
70	0498070.TXN	-	0MID070.XP
80	0498080.TXN	0MID080.X	0MID080.XP
100	0498100.TXN	-	0MID100.XP
125	0498125.TXN	-	0MID125.XP
150	0498150.TXN	-	0MID150.XP
175	-	-	0MID175.XP
200	0498200.TXN	-	0MID200.XP



Dimensions mm [inches]

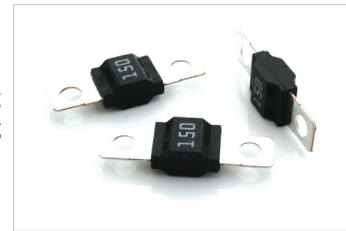
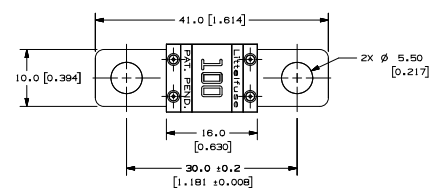

ZASE® • 40-600A

Designed for a one bolt connection M6 (125-250A) or M8 (300-600A) and can be used directly on a battery post or busbar connection. **Additional information:** Littelfuse.com/ZCASE

Voltage Rating Characteristics: 32V AC/DC, Slo-Blo®

CURRENT RATING (A)	BULK 480 PIECE MATERIAL NUMBER	BULK 100 PIECE MATERIAL NUMBER	CARDED MATERIAL NUMBER
40	3298040.Z	3298040.H	-
60	3298060.Z	3298060.H	-
80	3298080.Z	3298080.H	ZCAS080.XP
100	3298100.Z	3298100.H	ZCAS100.XP
125	3298125.Z	3298125.H	ZCAS125.XP
150	3298150.Z	3298150.H	ZCAS150.XP
175	3298175.Z	3298175.H	ZCAS175.XP
200	3298200.Z	3298200.H	ZCAS200.XP
225	3298225.Z	3298225.H	ZCAS225.XP
250	3298250.Z	3298250.H	ZCAS250.XP
300	3298300.ZXSTA	3298300.H	ZCAS300.XP
350	3298350.ZXSTA	3298350.H	ZCAS350.XP
400	3298400.ZXSTA	3298400.H	ZCAS400.XP
500	3298500.ZXSTA	3298500.H	ZCAS500.XP
600	3298600.ZXSTA	3298600.H	-



Dimensions [mm]

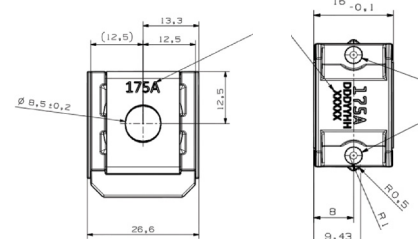

Auto Link Fuses

PAL Auto Link Fuses

Commonly found on Japanese and Domestic built vehicles in current ratings up to 140 amps. Available with female connector, male connector, bent connector and locking female connector. Color coded to indicate amp rating.

Additional information: Littelfuse.com/PAL

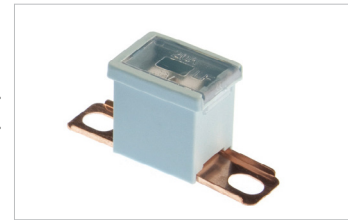

PAL Female Terminal

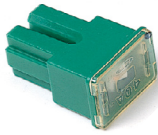

COLOR CODE	CURRENT RATING (A)	BOXED MATERIAL NUMBER	CARDED PACKAGING MATERIAL NUMBER
Blue	20	OPAL020.X	OPAL020.XP
Pink	30	OPAL030.X	OPAL030.XP
Green	40	OPAL040.X	OPAL040.XP
Red	50	OPAL050.X	OPAL050.XP
Yellow	60	OPAL060.X	OPAL060.XP

PAL Straight Male Terminal



COLOR CODE	CURRENT RATING (A)	BOXED MATERIAL NUMBER	CARDED PACKAGING MATERIAL NUMBER
Pink	30	OPAL130.X	OPAL130.XP
Yellow	60	OPAL160.X	OPAL160.XP
Black	80	OPAL180.X	OPAL180.XP
Blue	100	OPAL1100X	OPAL1100XP
Gray	120	OPAL1120X	OPAL1200XP

PAL MINI® Female Terminal

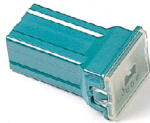

COLOR CODE	CURRENT RATING (A)	BOXED MATERIAL NUMBER	CARDED PACKAGING MATERIAL NUMBER
Pink	30	OPAL330.X	OPAL330.XP
Green	40	OPAL340.X	OPAL340.XP

PAL 9/16" Bent Male Terminal

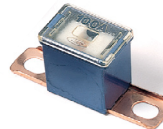

COLOR CODE	CURRENT RATING (A)	BOXED MATERIAL NUMBER	CARDED PACKAGING MATERIAL NUMBER
Pink	30	OPAL430.X	OPAL430.XP
Green	40	OPAL440.X	OPAL440.XP
Red	50	OPAL450.X	OPAL450.XP
Black	80	OPAL480.X	OPAL480.XP
Blue	100	OPAL4100X	OPAL4100XP
White	120	-	OPAL4120XP
Purple	140	-	OPAL4140XP

PAL Locking Female Terminal



COLOR CODE	CURRENT RATING (A)	BOXED MATERIAL NUMBER	CARDED PACKAGING MATERIAL NUMBER
Brown	25	OPAL525.X	OPAL525.XP
Green	30	OPAL530.X	OPAL530.XP

PAL 13/16" Bent Male Terminal

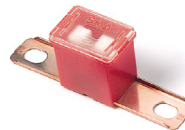

COLOR CODE	CURRENT RATING (A)	BOXED MATERIAL NUMBER	CARDED PACKAGING MATERIAL NUMBER
Pink	30	OPAL230.X	OPAL230.XP
Green	40	OPAL240.X	OPAL240.XP
Red	50	OPAL250.X	OPAL250.XP
Yellow	60	OPAL260.X	OPAL260.XP
Brown	70	OPAL270.X	OPAL270.XP
Black	80	OPAL280.X	OPAL280.XP
Blue	100	OPAL2100X	OPAL2100XP
Gray	120	OPAL2120X	OPAL2120XP
Purple	140	-	OPAL2140XP

Glass Fuses

Additional information: Littelfuse.com/GLASS

AG

Originally stood for “all glass.” The automotive industry uses the “AG” prefix (AGC, AGW) for most glass fuses. They vary in length, diameter and amperage rating.

Voltage Rating: 32V AC/DC, 250V may be substituted

CURRENT RATING (A)	BOXED MATERIAL NUMBER	CARDED PACKAGING MATERIAL NUMBER	CURRENT RATING (A)	BOXED MATERIAL NUMBER	CARDED PACKAGING MATERIAL NUMBER	CURRENT RATING (A)	BOXED MATERIAL NUMBER	CARDED PACKAGING MATERIAL NUMBER
AGC (1AG)			313 (3AG)			326 (3AG)		
1	0AGA001.V	0AGA001.VP	.25	-	0313.250VXP	.25	-	0326.250VXP
1.5	0AGA01.5V	-	.30	-	0313.300VXP	3	-	0326003.VXP
2	0AGA002.V	0AGA002.VP	.5	-	0313.500VXP	4	-	0326004.VXP
2.5	0AGA02.5V	-	1	-	0313001.VXP	15	-	0326015.VXP
3	0AGA003.V	0AGA003.VP	2	-	0313002.VXP	20	-	0326020.VXP
5	0AGA005.V	0AGA005.VP	3	-	0313003.VXP	25	-	0326025.VXP
6	0AGA006.V	-	4	-	0313004.VXP	AGU (5AG)		
7.5	0AGA07.5V	-	5	-	0313005.VXP	10	0AGU010.T	-
10	0AGA010.V	0AGA010.VP	7	-	0313007.VXP	15	0AGU015.T	-
15	0AGA015.V	0AGA015.VP	8	-	0313008.VXP	20	0AGU020.T	-
20	0AGA020.V	0AGA020.VP	1.2	-	031301.2VXP	25	0AGU025.T	-
25	0AGA025.V	-	1.5	-	031301.5VXP	30	0AGU030.T	-
30	0AGA030.V	0AGA030.VP	1.6	-	031301.6VXP	35	0AGU035.T	-
AGC (3AG)			10	-	0313010.VXP	40	0AGU040.T	0AGU040.VPG
.5	0AGC.500V	-	15	-	0313015.VXP	50	0AGU050.T	0AGU050.VPG
1	0AGC001.V	0AGC001.VP	2.5	-	031302.5VXP	60	0AGU060.T	0AGU060.VPG
1.5	0AGC01.5V	0AGC01.5VP	2.8	-	031302.8VXP	AGW (7AG)		
2	0AGC002.V	0AGC002.VP	20	-	0313020.VXP	1	0AGW01.V	-
2.5	0AGC02.5V	0AGC02.5VP	25	-	0313025.VXP	1.5	0AGW01.5V	-
3	0AGC003.V	0AGC003.VP	32	-	0313032.VXP	2.5	0AGW02.5V	-
4	0AGC004.V	0AGC004.VP	30	-	0313030.VXP	3	0AGW003.V	-
5	0AGC005.V	0AGC005.VP	1.25	-	03131.25VXP	4	0AGW004.V	-
6	0AGC006.V	0AGC006.VP	6.25	-	03136.25VXP	5	0AGW005.V	0AGW005.VP
7.5	0AGC07.5V	0AGC07.5VP	314 (3AB)			6	0AGW006.V	-
8	0AGC008.V	-	1	-	0314001.VXP	15	0AGW015.V	0AGW015.VP
10	0AGC010.V	0AGC010.VP	5	-	0314005.VXP	20	0AGW020.V	0AGW020.VP
15	0AGC015.V	0AGC015.VP	10	-	0314010.VXP	30	0AGW030.V	0AGW030.VP
20	0AGC020.V	0AGC020.VP	12	-	0314012.VXP	AGX (8AG)		
25	0AGC025.V	0AGC025.VP	15	-	0314015.VXP	2	0AGX002.V	-
30	0AGC030.V	0AGC030.VP	20	-	0314020.VXP	20	-	0AGX020.VP
35	0AGC035.V	0AGC035.VP				25	-	0AGX025.VP
						30	-	0AGX030.VP



SFE

Glass fuses designed to specifications set by the Society of Fuse Engineers. All are 1/4 inch in diameter, but vary in length according to the ampere rating to ensure accurate fuse replacement.

Voltage Rating: 32V AC/DC, 250V may be substituted

CURRENT RATING (A)	BOXED MATERIAL NUMBER	CARDED PACKAGING MATERIAL NUMBER
4	0SFE004.V	0SFE004.VP
6	0SFE006.V	0SFE006.VP
7.5	0SFE07.5V	0SFE07.5VP
9	0SFE009.V	0SFE009.VP
14	0SFE014.V	0SFE014.VP
20	0SFE020.V	0SFE020.VP
30	0SFE030.V	0SFE030.VP



Glass Fuses

235

The 235 Series 5x20mm fast-acting glass body cartridge fuse designed to UL specification. Designed to UL/CSA/ANCE 248 Standard.

Additional information: Littelfuse.com/235

Voltage Rating: 32V AC/DC, 250V may be substituted

CURRENT RATING (A)	CARDED PACKAGING MATERIAL NUMBER
.5	0235.500VXP
.6	0235.600VXP
.8	0235.800VXP
1	0235001.VXP
1.25	02351.25VXP
1.6	023501.6VXP

CURRENT RATING (A)	CARDED PACKAGING MATERIAL NUMBER
2	0235002.VXP
2.5	023502.5VXP
3	0235003.VXP
4	0235004.VXP
5	0235005.VXP
6	0235006.VXP



GBC • Torpedo Fuse

A thermoplastic type, torpedo shaped fuse that can be currently found in many European cars. Consisting of a heat resistant body, the fuse element stretches over the exterior of the body from end to end. The bodies vary in color (by amperage) to ensure proper replacement.

Voltage Rating: 32V AC/DC, 250V may be substituted

CURRENT RATING (A)	BOXED MATERIAL NUMBER	CARDED PACKAGING MATERIAL NUMBER
5	0GBC005.V	-
8	0GBC008.V	0GBC008.VP
16	0GBC016.V	0GBC016.VP
25	0GBC025.V	0GBC025.VP



RK5 Series Fuses • 125-300V DC • 0.1-600A **NEW**

A dependable choice for safeguarding electrical circuits against overcurrents and short circuits. These time-delay fuses are engineered to deliver outstanding performance and reliability.

Additional information: Littelfuse.com/RK5

Voltage Rating: FLNR: 125V DC - 90-100A FLSR: 300 V DC - 80-100A

CURRENT RATING (A)	CARDED MATERIAL NUMBER
FLNR	
90	FLNR090.V
100	FLNR100.V

CURRENT RATING (A)	CARDED MATERIAL NUMBER
FLSR	
80	FLSR080.V
100	FLSR100.V



Honda, Volkswagen & Universal Fusible Links

Honda: Fusible links fit Honda Civics fusible link bar. Available in 45, 55 & 65A. Carded merchandise only available in 3 piece assortment 094413.

Volkswagen: Fusible links fit Volkswagen and Universal fusible link bars. Available in 30, 40, 50, 60, 80, 110, 150 & 175A fuse bars.

Universal: Fusible links are OEM replacement fusible link bars. Available in 30, 50, 80 & 100A.

CARDED PART NUMBER MATERIAL NUMBER	CARDED PART NUMBER CATALOG NUMBER	DESCRIPTION
00940413ZP	094413	Fusible Link assortment - fits Honda vehicles
00940402ZP	0940402	Fusible Link assortment - fits Volkswagen vehicles
0FLC014.XP	FLC14BP	Fusible Link 14 AWG
0FLW014.XP	FLW14BP	Fusible Link 14 AWG with Terminals
0FLW016.XP	FLW16BP	Fusible Link 16 AWG with Terminals



Specialty Fuse Products

CNNe, CNN, CNL Forklift Type Fuses

CNNe fuses are rated for applications up to 80V DC. As fork lift trucks voltages increase, circuit protection needs to be rated higher to handle the increased voltage. The 80V CNN_E and 48V CNN are considered very fast-acting for quicker reaction time, the 32V CNL fuses are fast-acting.

Additional information: Littelfuse.com/CNN

Voltage Rating: **CNNe:** 80V DC / 125V AC; **CNN:** 48V DC / 125V AC; **CNL:** 32V DC / 32V AC
Ampere Range: 10-800A; Interrupting Rating: 2,500A; Maximum Torque: 90 lbs



PART NUMBER MATERIAL NUMBER	PART NUMBER CATALOG NUMBER	V DC	PART NUMBER MATERIAL NUMBER	PART NUMBER CATALOG NUMBER	V DC	PART NUMBER MATERIAL NUMBER	PART NUMBER CATALOG NUMBER	V DC
CNNe			CNN			CNL		
OCNN035E.V	CNN035E	80	OCNN010.V	CNN010	48	OCNL035.V	CNL035	32
OCNN040E.V	CNN040E	80	OCNN035.V	CNN035	48	OCNL040.V	CNL040	32
OCNN050E.V	CNN050E	80	OCNN040.V	CNN040	48	OCNL050.V	CNL050	32
OCNN060E.V	CNN060E	80	OCNN050.V	CNN050	48	OCNL060.V	CNL060	32
OCNN080E.V	CNN080E	80	OCNN060.V	CNN060	48	OCNL080.V	CNL080	32
OCNN090E.V	CNN090E	80	OCNN080.V	CNN080	48	OCNL100.V	CNL100	32
OCNN100E.V	CNN0100E	80	OCNN090.V	CNN090	48	OCNL125.V	CNL125	32
OCNN125E.V	CNN0125E	80	OCNN100.V	CNN100	48	OCNL150.V	CNL150	32
OCNN150E.V	CNN0150E	80	OCNN125.V	CNN125	48	OCNL175.V	CNL175	32
OCNN175E.V	CNN0175E	80	OCNN150.V	CNN150	48	OCNL200.V	CNL200	32
OCNN200E.V	CNN0200E	80	OCNN175.V	CNN175	48	OCNL225.V	CNL225	32
OCNN225E.V	CNN0225E	80	OCNN200.V	CNN200	48	OCNL250.V	CNL250	32
OCNN250E.V	CNN0250E	80	OCNN225.V	CNN225	48	OCNL275.V	CNL275	32
OCNN275E.V	CNN0275E	80	OCNN250.V	CNN250	48	OCNL300.V	CNL300	32
OCNN300E.V	CNN0300E	80	OCNN275.V	CNN275	48	OCNL325.V	CNL325	32
OCNN325E.V	CNN0325E	80	OCNN300.V	CNN300	48	OCNL350.V	CNL350	32
OCNN350E.V	CNN0350E	80	OCNN325.V	CNN325	48	OCNL400.V	CNL400	32
OCNN400E.V	CNN0400E	80	OCNN350.V	CNN350	48	OCNL500.V	CNL500	32
OCNN500E.V	CNN0500E	80	OCNN400.V	CNN400	48			
OCNN600E.V	CNN0600E	80	OCNN500.V	CNN500	48			
OCNN700E.V	CNN0700E	80	OCNN600.V	CNN600	48			
OCNN800E.V	CNN0800E	80	OCNN700.V	CNN700	48			
			OCNN800.V	CNN800	48			

JLLN & JLLS Series Fuses • 160/300V DC • 1-1200A • UL Class T

Additional information: Littelfuse.com/JLNN or Littelfuse.com/JLLS

Voltage Rating: JLLN: 160V DC (1-60A); 125V DC (70-1200A except 900A) JLLS: 300V DC (1-1200A)



CURRENT RATING (A)	MATERIAL NUMBER	V DC	PACK SIZE	CURRENT RATING (A)	MATERIAL NUMBER	V DC	PACK SIZE	CURRENT RATING (A)	MATERIAL NUMBER	V DC	PACK SIZE	CURRENT RATING (A)	MATERIAL NUMBER	V DC	PACK SIZE
JLNN				JLNN				JLLS				JLLS			
1	JLLN001.T	160	10	110	JLLN110.X	125	1	1	JLLS001.T	300	10	125	JLLS125.X	300	1
2	JLLN002.T	160	10	125	JLLN125.X	125	1	2	JLLS002.T	300	10	150	JLLS150.X	300	1
3	JLLN003.T	160	10	150	JLLN150.X	125	1	3	JLLS003.T	300	10	175	JLLS175.X	300	1
6	JLLN006.T	160	10	175	JLLN175.X	125	1	6	JLLS006.T	300	10	200	JLLS200.X	300	1
10	JLLN010.T	160	10	200	JLLN200.X	125	1	10	JLLS010.T	300	10	225	JLLS225.X	300	1
15	JLLN015.T	160	10	225	JLLN225.X	125	1	15	JLLS015.T	300	10	250	JLLS250.X	300	1
20	JLLN020.T	160	10	250	JLLN250.X	125	1	20	JLLS020.T	300	10	300	JLLS300.X	300	1
25	JLLN025.T	160	10	300	JLLN300.X	125	1	25	JLLS025.T	300	10	350	JLLS350.X	300	1
30	JLLN030.T	160	10	350	JLLN350.X	125	1	30	JLLS030.T	300	10	400	JLLS400.X	300	1
35	JLLN035.T	160	10	400	JLLN400.X	125	1	35	JLLS035.T	300	10	450	JLLS450.X	300	1
40	JLLN040.T	160	10	450	JLLN450.X	125	1	40	JLLS040.T	300	10	500	JLLS500.X	300	1
45	JLLN045.T	160	10	500	JLLN500.X	125	1	45	JLLS045.T	300	10	600	JLLS600.X	300	1
50	JLLN050.T	160	10	600	JLLN600.X	125	1	50	JLLS050.T	300	10	700	JLLS700.X	300	1
60	JLLN060.T	160	10	700	JLLN700.X	125	1	60	JLLS060.T	300	10	800	JLLS800.X	300	1
70	JLLN070.T	125	5	800	JLLN800.X	125	1	70	JLLS070.V	300	5	900	JLLS900.X	300	1
80	JLLN080.T	125	5	1000	JLLN1000X	125	1	80	JLLS080.V	300	5	1000	JLLS1000X	300	1
90	JLLN090.T	125	5	1100	JLLN1100X	125	1	90	JLLS090.V	300	5	1100	JLLS1100X	300	1
100	JLLN100.V	125	5	1200	JLLN1200X	125	1	100	JLLS100.V	300	5	1200	JLLS1200X	300	1
								110	JLLS110.X	300	1				

Assortment Kits

Value Pack Kits

The Littelfuse Value Packs contain a complete assortment of OEM fuses. Value Packs give you the tools for the protection you need — when and where you need it! The Ultimate fuse kit for home and repair shop comes in a clear plastic, reusable package.

MATERIAL NUMBER	CATALOG NUMBER	DESCRIPTION
00940400Z	094400	ATO Super Value Pack 40 piece
00940462Z	094462	MINI Super Value Pack 40 piece
00940475Z	094475	ATO, MINI, MAXI Super Value Pack 21 piece
00940550Z	094550	MINI / CASE Super Value Pack 29 piece
00940554Z	-	Low Profile MINI / Low Profile JCASE Super Value Pack 30 piece
00940557ZXA	-	AGC Glass Super Value Pack 40 piece
00940566ZXA	-	MICRO2 / MICRO3 Super Value Pack 60 piece



Fuse Assortment Kits

Littelfuse assortments contain a variety of a specific fuse type in assorted amperages.

MATERIAL NUMBER	CATALOG NUMBER	DESCRIPTION	CONTENTS
00940133ZP	94133	European Fuse Assortment	2 each: GBC 8A, 16A Fuses & 1 each: GBC 25A
00940134ZP	94134	British Fuse Assortment	1 each: AGC 7.5A, 15A, 20A (SFE 20) 1 each: 03000128M Amp Fuses
00940135ZP	94135	Japanese Fuse Assortment	1 each: AGC 5A, 10A, 15A, 20A (SFE 20), 30A Fuses
00940154ZP	94154	American Fuse Assortment	1 each: AGC 10A, 15A, 30A & 1 each: SFE 9A, 14A, 20A Fuses
00940189ZP	94189	Cellular Fuse Assortment	1 each: AGC 1.5A, 3A Fuses & 3 each: AGC 2A Fuses
00940202ZP	94202	ATO Fuse Assortment 6pc	1 each: ATO 5A, 10A, 15A, 20A, 25A, 30A Fuses
00940301ZP	94301	Japanese ATO Fuse Assortment	1 each: ATO 5A, 7.5A, 10A, 15A, 20A Fuses
00940362ZP	94362	MINI Fuse Assortment	1 each: MINI 3A, 5A, 7.5A, 10A, 15A, 20A, 25A, 30A
00940408ZP	94408	Computer Fuse Assortment	1 each: AGC .5A Fuses & 2 each: AGC 1A, 2A Fuses
00940506ZP	94506	Low Profile MINI Fuse Assortment	1 each: LMIN 7.5A, 10A, 15A, 20A, 25A, 30A Fuses
00940558ZPA	94558	MICRO2 Fuse Assortment	1 each: MICRO2 5A, 10A, 15A, 20A, 25A Fuses
00940559ZPA	94559	MCASE Fuse Assortment	1 each: 15A, 20A, 25A, 30A, 40A Fuses
0AGA0001ZP	AGA1ZP	AGA Glass Fuse Assortment	1 each: AGA 1A, 2A, 3A, 5A, 7.5A, 10A, 15A, 20A, 25A, 30A Fuses
0AGA0002ZP	AGA2ZP	AGA Glass Fuse Assortment	1 each: AGA 2A, 3A, 10A Fuses & 2 each: AGA 5A Fuses
0AGA0003ZP	AGA3ZP	AGA Glass Fuse Assortment	1 each: AGA 15A Fuse & 2 each: AGA 20A, 30A Fuses
0AGC0001ZP	AGC1ZP	AGC Glass Fuse Assortment	1 each: AGC 1A, 2A, 2.5A, 3A, 4A, 5A, 6A, 7.5A, 8A, 10A, 15A, 20A, 25A, 30A, 35A Fuses
0AGC0002ZP	AGC2ZP	AGC Glass Fuse Assortment	1 each: AGC 1A, 2A, 2.5A Fuses & 2 each: AGC 3A Fuses
0AGC0003ZP	AGC3ZP	AGC Glass Fuse Assortment	1 each: AGC 4A, 6A, 7.5A Fuses & 2 each: AGC 5A Fuses
0AGC0004ZP	AGC4ZP	AGC Glass Fuse Assortment	1 each: AGC 10A Fuse & 2 each: AGC 15A, 20A Fuses
0AGC0005ZP	AGC5ZP	AGC Glass Fuse Assortment	1 each: AGC 35A Fuse & 2 each: AGC 25A, 30A Fuses
0AGW0001ZP	AGW1ZP	AGW/AGX Glass Fuse Assortment	1 each: AGW 3A, 4A, 5A, 15A, 20A, 30A Fuses 1 each: AGX 3A, 20A, 25A, 30A Fuses
0AGW0002ZP	AGW2ZP	AGW Glass Fuse Assortment	1 each: AGW 5A, 20A, 30A Fuses & 2 each: AGW 15A Fuses
0AGX0002ZP	AGX2ZP	AGX Glass Fuse Assortment	1 each: AGX 25A, 30A Fuses & 3 each: AGX 20A Fuses
OSFE0001ZP	SFE1ZP	SFE Glass Fuse Assortment	1 each: SFE 4A, 6A, 7.5A, 9A Fuses & 2 each: 14A, 20A, 30A Fuses
MATERIAL NUMBER	CATALOG NUMBER	DESCRIPTION	CONTENTS
SMART GLOW FUSE			
00940202ZPGLO	10-1008	ATO SmartGlow Assortment 5 pack	1 each: ATO 10A, 15A, 20A, 25A, 30A Fuses
00940362ZPGLO	11-1008	MINI SmartGlow Assortment 5 pack	1 each: ATO 10A, 15A, 20A, 25A, 30A Fuses
00940400ZGLO	14-0000	ATO SmartGlow Assortment 42 pack	7 each: ATO GLO 5A, 10A, 15A, 20A, 25A, 30A Fuses
00940462ZGLO	15-0000	MINI SmartGlow Assortment 36 pack	6 each: MINI GLO 5A, 10A, 15A, 20A, 25A, 30A Fuses
00940555ZPGLO	-	ATO SmartGlow Assortment 5 Pack w/ Flashlight	1 each: ATO GLO 10A, 15A, 20A, 25A, 30A Fuses & (1) MINI Keychain LED Flashlight
00940556ZPGLO	094556	MINI SmartGlow Assortment 5 Pack w/ Flashlight	1 each: MINI GLO 10A, 15A, 20A, 25A, 30A Fuses & (1) MINI Keychain LED Flashlight
0AGC0001ZPGLO	16-1008	AGC Glass Assortment 5 pack	1 each: AGC 5A, 10A, 15A, 20A, 30A Fuses
OSFE0001ZPGLO	-	SFE Glass SmartGlow Assortment 5 pack	1 each: SFE 7.5A, 9A, 14A & 2 each: 20A Fuses



SMART GLOW FUSE



Assortment Kits

Emergency Kits

Available in OEM ATO and MINI fuse versions. The Littelfuse Emergency Diagnostic Fuse Kits are ideal for the glove box or trunk offering instant protection in the garage or on the road. Contains the most popular amperages.

Includes roadside tester/puller that tests, removes and installs fuses. Has its own power source that allows it to operate with or without voltage to a maximum of 24V DC.



MATERIAL NUMBER	CATALOG NUMBER	DESCRIPTION	CONTENTS
00940363ZP	094363	MINI Emergency Fuse Kit	1 each: MINI 3A, 5A, 7.5A, 10A, 15A, 20A, 25A, 30A Fuses; (1) Puller
00940365ZP	094365	Motorcycle Glass Emergency Kit	1 each: AGX 5A, 10A, 15A, 20A Fuses 2 each: AGX 8A Fuses; (1) Puller
00940366ZP	094366	Motorcycle ATO Emergency Kit	1 each: ATO 5A, 7.5A, 10A, 15A, 20A Fuses; (1) Puller
00940367ZP	094367	American Glass Emergency Kit	1 each: SFE 9A, 14A, 20A 1 each: AGC 5A, 15A, 30A Fuses; (1) Puller
00940368ZP	094368	European GBC Emergency Kit	1 each: GBC 5A, 16A, 25A Fuses; 2 each: GBC 8A Fuses; (1) Puller
00940369ZP	094369	Japanese Glass Emergency Kit	1 each: AGC 5A, 10A, 15A, 20A, 30A Fuses; (1) Puller
00940370ZP	094370	ATO Emergency Kit	1 each: ATO 5A, 10A, 15A, 20A, 25A, 30A Fuses; (1) Puller
00940418ZP	094418	ATO Emergency Diagnostic Kit	1 each: ATO 5A, 10A, 15A, 20A, 25A, 30A Fuses; (1) ATO Puller
00940419ZP	094419	Glass Emergency Fuse Kit	1 each: AGC 7.5A, 15A, 20A, 25A, 30A; (1) Glass Puller
00940461ZP	094461	MINI Emergency Diagnostic Kit	1 each: MINI 3A, 4A, 7.5A, 10A, 15A, 20A, 25A, 30A Fuses (1) ATO/MINI Tester/Puller
00940479ZP	094479	ATO / MINI Emergency Diagnostic Kit	1 each: ATO 5A, 10A, 15A, 20A, 25A, 30A Fuses 1 each: MINI 3A, 5A, 7.5A, 10A, 15A, 20A, 25A, 30A Fuses; (1) Puller
00940441ZP	094441	LP MINI Emergency Fuse Kit	1 each: LP MINI 2A, 5A, 7.5A, 10A, 15A, 20A, 25A, 30A Fuses; (1) Puller
00940442ZP	094442	MCASE, MICRO2, MICRO3 Emergency Kit	1 each: MCASE 15A, 20A, 25A, 30A, 40A Fuses, (1) MCase Puller 1 each: MICRO2 5A, 7.5A, 10A, 15A, 20A, 25A, 30A Fuses 1 each: MICRO3 5A, 7.5A, 10A, 15A Fuses, (1) MICRO Puller
00940561ZPA	094561	GM - OEM Emergency Kit	1 each: MINI 7.5A, 25A, 30A Fuses 1 each: LP MINI 10A, 15A Fuses 1 each: JCASE 20A, 30A, 40A, 50A Fuses 1 each: LPJCASE 30A, 40A Fuses 2 each: MINI 20A Fuses 3 each: MINI 10A, 15A Fuses
00940562ZPA	094562	Ford - OEM Emergency Kit	1 each: MINI 7.5A, 25A, 30A Fuses 1 each: LP MINI 10A, 15A Fuses 1 each: JCASE 20A, 30A, 40A, 50A Fuses 1 each: LPJCASE 30A, 40A Fuses 2 each: MINI 20A Fuses 3 each: MINI 10A, 15A Fuses
00940563ZPA	094563	Chrysler / Dodge / Jeep - OEM Emergency Kit	1 each: MINI 7.5A, 25A, 30A Fuses 1 each: JCASE 20A, 30A, 40A, 50A Fuses 2 each: MINI 20A Fuses 3 each: MINI 10A, 15A Fuses
00940565ZPA	094565	Toyota / Lexus - Emergency Fuse Kit	1 each: MICRO2 5A, 7.5A, 10A, 15A, 20A, 25A, 30A Fuses 1 each: LP MINI 5A, 7.5A, 10A, 15A, 20A, 30A Fuses; (2) Pullers
00940566ZPA	094566	Nissan / Infiniti - Emergency Fuse Kit	1 each: MICRO2 5A, 10A, 15A, 20A, 30A Fuses 1 each: MINI 2A, 3A, 4A, 5A, 7.5A, 10A, 15A, 20A, 25A, 30A Fuses 1 each: ATO 5A, 7.5A, 10A, 15A, 20A, 30A, 40A Fuses 1 each: MCASE+ 30A, 40A, 60A, Fuses 2 each: MCASE+ 50A Fuses; (3) Pullers
00940567ZPA	094567	Volkswagen / Audi - Emergency Fuse Kit	1 each: ATO 1A, 2A, 3A, 4A, 5A, 7.5A, 10A, 15A, 20A, 25A 30A, 40A Fuses 1 each: MINI 2A, 3A, 5A, 7.5A, 10A, 15A, 20A, 25A, 30A Fuses 1 each: JCASE 20A, 25A, 30A, 40A, 50A, 60A Fuses 1 each: HSB 40A, 50A, 80A, 110A, 175A Fuse Strip; (2) Pullers
00940569ZPA	094569	Hyundai / Kia / Genesis - Emergency Fuse Kit	1 each: MINI 10A, 15A, 20A, 25A, 30A Fuses 1 each: LP MINI 7.5A, 10A, 15A, 20A, 25A, 30A Fuses 1 each: JCASE 30A, 40A, 50A Fuses 1 each: LPJCASE 20A, 30A, 40A Fuses 1 each: MICRO2 10A, 15A, 20A, 25A 30A Fuses; (3) Pullers
00940570ZPA	0940570	NEW Honda / Acura - Emergency Fuse Kit	3 Each: LP MINI 7.5A, 10A, 15A, 20A 2 Each: LP MINI 30A 2 Each: JCASE, 30A, 40A 1 Each: MINI, 20A 1 Each: PAL 283, 70A, 80A; (2) Pullers
00940572ZPA	0940572	NEW Subaru - Emergency Fuse Kit	3 Each: LP MINI 7.5A, 10A, 15A, 20A 1 Each: JCASE, 40A, 60A 3 Each: MINI, 20A 2 Each: MCASE+ Unslotted, 20A, 30A, 40A; (2) Pullers
00940571ZPA	0940571	NEW Powersports - Emergency Fuse Kit	1 Each: MINI, 5A, 7.5A, 10A, 15A, 20A, 25A, 30A, 40A, 50A 1 Each: ATO, 5A, 7.5A, 10A, 15A, 20A, 25A, 30A 1 Each: Circuit Breaker, 15A, 30A 2 Each: SFE, 9A 2 Each: FA 3AG, 10A 1 Each: PAL 293, 50A; (1) Pullers



Assortment Kits

Commercial Assortments

Littelfuse Commercial Assortments cover all of the professional technician's circuit protection needs. Littelfuse offers the most comprehensive circuit protection kits on the market today addressing the needs of the Professional Service Center and Road Service Operation with genuine Littelfuse OEM fuses. Littelfuse Commercial Assortments are designed for the professional installer who needs a larger quantity and variety of fuses at the point of installation. Assortments are packaged in tough plastic storage containers perfect for the parts drawer, tool box, under counter or road service vehicle. **Additional information:** Littelfuse.com/KitAssortments



ATO® • 80 Piece



CARDED MATERIAL NUMBER	CARDED CATALOG NUMBER	CONTENT
00940409Z	094409	10 piece: 3A, 5A, 7.5A, 10A, 15A, 20A, 25A, 30A

ATO® / MINI® • 80 Piece



CARDED MATERIAL NUMBER	CARDED CATALOG NUMBER	CONTENT
00940422Z	094422	ATO 10 piece: 15A, 20A, 25A, 30A; MINI 10 piece: 15A, 20A, 25A, 30A (1) Puller

MINI® • 80 Piece



CARDED MATERIAL NUMBER	CARDED CATALOG NUMBER	CONTENT
00940551Z	094551	10 piece: 3A, 5A, 7.5A, 10A, 15A, 20A, 25A, 30A

Low Profile MINI® • 80 Piece



CARDED MATERIAL NUMBER	CARDED CATALOG NUMBER	CONTENT
00940552Z	094552	10 piece: 3A, 5A, 7.5A, 10A, 15A, 20A, 25A, 30A

Low Profile JCASE® • 16 Piece



CARDED MATERIAL NUMBER	CARDED CATALOG NUMBER	CONTENT
00940553Z	094553	4 piece: 20A, 30A, 40A; 2 piece: 50A, 60A (1) Puller

Commercial & Fleet Emergency Fuse Kit • 50 Piece **NEW**



CARDED MATERIAL NUMBER	CONTENT
00941003Z	ATO 2 piece: 5A, 7.5A, 10A, 15A, 20A, 25A, 30A; MINI 2 piece: 2A, 3A, 5A, 7.5A, 10A, 15A, 20A, 25A, 30A; MIDI 1 piece: 30A, 100A, 125A, 150A, 175A, 200A; MEGA 1 piece: 150A, 250A; MAXI 2 piece: 20A, 25A, 30A, 40A, 50A (1) ATO / MINI Puller; (1) MAXI Puller

MICRO2® • 70 Piece



CARDED MATERIAL NUMBER	CARDED CATALOG NUMBER	CONTENT
00940560ZXA	00940560	10 piece: 5A, 7.5A, 10A, 15A, 20A, 25A, 30A

MICRO2® / MICRO3® / MCASE® • 135 Piece



CARDED MATERIAL NUMBER	CARDED CATALOG NUMBER	CONTENT
00940570ZXA	00940570	MICRO2 10 piece: 5A, 7.5A, 10A, 15A, 20A, 25A, 30A; MICRO3 10 piece: 5A, 7.5A, 10A, 15A; MCASE 5 piece: 15A, 20A, 25A, 30A, 40A

MCASE® • 80 Piece



CARDED MATERIAL NUMBER	CARDED CATALOG NUMBER	CONTENT
00940565ZXA	00940565	20 piece: 20A, 25A, 30A, 40A

JCASE® • 10 Piece



CARDED MATERIAL NUMBER	CARDED CATALOG NUMBER	CONTENT
00940480Z	094480	2 piece: 20A, 40A, 50A; 3 piece: 30A - 1 piece: 60A (1) Puller

Assortment Kits

Smart Glow Commercial Assortments

Littelfuse Commercial Assortments cover the professional technician's circuit protection needs including Smart Glow style fuses. Available in ATO and MINI fuse styles the assortments are packaged in tough plastic storage containers perfect for the parts drawer, tool box, under counter or road service vehicle.

Additional information: Littelfuse.com/KitAssortments



SMART GLOW FUSE®

It glows when it blows.

Smart Glow ATO® • 80 Piece



CARDED MATERIAL NUMBER	CONTENT
00940509ZXGLOA	10 piece: 3A, 5A, 7.5A, 10A, 15A, 20A, 25A, 30A

Smart Glow MINI® • 80 Piece



CARDED MATERIAL NUMBER	CONTENT
00940510ZXGLOA	10 piece: 3A, 5A, 7.5A, 10A, 15A, 20A, 25A, 30A

Professional Fuse Caddy Commercial Assortment

Provides a complete assortment designed to meet the professional installer's on-the-road fuse needs. Contains 180 of the most popular fuses and installation tools (includes ATO®/MINI® Tester/ Puller) needed to service passenger cars and light trucks, heavy and medium trucks and buses. Comes in compact handy storage box perfect for the on-the-road vehicle.

Additional information: Littelfuse.com/KitAssortments

180 Piece

CARDED MATERIAL NUMBER	CARDED CATALOG NUMBER	CONTENT
00940396Z	094396	ATO 5 piece: 3A, 5A, 7.5A - 10 piece: 10A, 25A - 15 piece: 15A, 20A, 30A MINI 5 piece: 2A, 3A, 4A, 5A, 7.5A, 10A, 15A, 20A, 25A, 30A AGC 5 piece: 5A, 10A, 15A, 20A, 25A, 30A SFE 5 piece: 14A, 20A, 30A MAXI 5 piece: 20A, 30A, 40A, 50A, 60A (1) Fuse Tester and Puller (1) Tri-puller™ (1) MAXI Fuse Puller



Assortment Kits

Red Box™

Designed by Littelfuse, the kit features the exact OEM parts used for the glass, ATO, MINI, LP MINI, MAXI, PAL, JCASE, LP JCASE, MCASE, MICRO2 and MICRO3 fuses installed on over 98% of the cars, vans, light trucks and SUV's on the road today. All come packed inside one compact, portable, organized carrying case. With Red Box, your days of wasting valuable shelf space on redundant part numbers is over. Over 500 fuses inside Red Box meet over 98% of the market's circuit protection needs, giving you more coverage and more profit with a lot less inventory.



Additional information: Littelfuse.com/RedBox

KIT Professional Installer Case

MATERIAL NUMBER	CATALOG NUMBER	No Glass with Module 5		No Glass with Module 6
MATERIAL NUMBER	CATALOG NUMBER	MATERIAL NUMBER	CATALOG NUMBER	MATERIAL NUMBER
ORED0BOXZ	REDBOX	ORED0BOXZXNG	REDBOXNG	ORED0BOXZXNGA

Low Profile MINI® • Module 1

MATERIAL NUMBER	CATALOG NUMBER	PACK SIZE
ORBOX001Z	RBOX1	
LMIN005.V	Low Profile MINI Fuse 5A	5
LMIN07.5V	Low Profile MINI Fuse 7.5A	10
LMIN010.V	Low Profile MINI Fuse 10A	10
LMIN015.V	Low Profile MINI Fuse 15A	10
LMIN020.V	Low Profile MINI Fuse 20A	5
LMIN025.V	Low Profile MINI Fuse 25A	5
LMIN030.V	Low Profile MINI Fuse 30A	10

JCASE® • Module 2

MATERIAL NUMBER	CATALOG NUMBER	PACK SIZE
ORBOX002Z	RBOX2	
JCAS020.V	JCASE 32 V S/B Box 20A	2
JCAS030.V	JCASE 32 V S/B Box 30A	2
JCAS040.V	JCASE 32 V S/B Box 40A	2
JCAS050.V	JCASE 32 V S/B Box 50A	2
JCAS060.V	JCASE 32 V S/B Box 60A	2

Glass • Module 5

MATERIAL NUMBER	CATALOG NUMBER	PACK SIZE
ORBOX005Z	RBOX5	
OAGC001.V	AGC Glass Box 1A	10
OAGC002.V	AGC Glass Box 2A	10
OAGC003.V	AGC Glass Box 3A	10
OAGC004.V	AGC Glass Box 4A	10
OAGC005.V	AGC Glass Box 5A	10
OAGC006.V	AGC Glass Box 6A	10
OAGC007.5V	AGC Glass Box 7.5A	10
OAGC010.V	AGC Glass Box 10A	10
OAGC015.V	AGC Glass Box 15A	10
OAGC020.V	AGC Glass Box 20A	10
OAGC025.V	AGC Glass Box 25A	10
OAGC030.V	AGC Glass Box 30A	10
OAGW030.V	AGW Glass Box 30A	10
OAGX030.V	AGX Glass Box 30A	10
OSFE004.V	SFE Glass Box 4A	10
OSFE009.V	SFE Glass Box 9A	10
OSFE014.V	SFE Glass Box 14A	10
OSFE020.V	SFE Glass Box 20A	10
OSFE030.V	SFE Glass Box 30A	10
	Puller Tester	1

Blade Fuse • Module 3

MATERIAL NUMBER	CATALOG NUMBER	PACK SIZE
ORBOX003Z	RBOX3	
OATO005.V	ATO Blade Fuse Box 5A	10
OATO07.5V	ATO Blade Fuse Box 7.5A	10
OATO010.V	ATO Blade Fuse Box 10A	25
OATO015.V	ATO Blade Fuse Box 15A	25
OATO020.V	ATO Blade Fuse Box 20A	25
OATO025.V	ATO Blade Fuse Box 25A	25
OATO030.V	ATO Blade Fuse Box 30A	25
OATO040.V	ATO Blade Fuse Box 40A	10
OMIN005.V	MINI Blade Fuse Box 5A	10
OMIN07.5V	MINI Blade Fuse Box 7.5A	10
OMIN010.V	MINI Blade Fuse Box 10A	20
OMIN015.V	MINI Blade Fuse Box 15A	20
OMIN020.V	MINI Blade Fuse Box 20A	20
OMIN025.V	MINI Blade Fuse Box 25A	10
OMIN030.V	MINI Blade Fuse Box 30A	10
OMAX020.V	MAXI Blade Box 20A	2
OMAX030.V	MAXI Blade Box 30A	2
OMAX040.V	MAXI Blade Box 40A	2
OMAX050.V	MAXI Blade Box 50A	2
OMAX060.V	MAXI Blade Box 60A	2
OMAX070.V	MAXI Blade Box 70A	1
OMAX080.V	MAXI Blade Box 80A	1
00970019X	Fuse Tester & Puller Box	1
FHAC0002Z	ATO HD Inline Fuse Holder Box	1
OFHM0002Z	MINI HD Inline Fuse Holder Box	1

PAL • Module 4

MATERIAL NUMBER	CATALOG NUMBER	PACK SIZE
ORBOX004Z	RBOX4	
OPAL020.X	Female Term Box 20A	1
OPAL030.X	Female Term Box 30A	1
OPAL040.X	Female Term Box 40A	1
OPAL050.X	Female Term Box 50A	1
OPAL060.X	Female Term Box 60A	1
OPAL130.X	Straight Male Term Box 30A	1
OPAL160.X	Straight Male Term Box 60A	1
OPAL180.X	Straight Male Term Box 80A	1
OPAL1100.X	Straight Male Term Box 100A	1
OPAL1120.X	Straight Male Term Box 120A	1
OPAL230.X	13/16" Bent Male Term Box 30A	1
OPAL240.X	13/16" Bent Male Term Box 40A	1
OPAL250.X	13/16" Bent Male Term Box 50A	1
OPAL260.X	13/16" Bent Male Term Box 60A	1
OPAL270.X	13/16" Bent Male Term Box 70A	1
OPAL280.X	13/16" Bent Male Term Box 80A	1
OPAL2100.X	13/16" Bent Male Term Box 100A	1
OPAL2120.X	13/16" Bent Male Term Box 120A	1
OPAL330.X	MINI Female Term Box 30A	1
OPAL340.X	MINI Female Term Box 40A	1
OPAL430.X	9/16" Bent Male Term Box 30A	1
OPAL440.X	9/16" Bent Male Term Box 70A	1
OPAL450.X	9/16" Bent Male Term Box 50A	1
OPAL480.X	9/16" Bent Male Term Box 80A	1
OPAL4100.X	9/16" Bent Male Term Box 100A	1
OPAL525.X	Locking Female Term Box 25A	1
OPAL530.X	Locking Female Term Box 30A	1

MICRO2®, MICRO3®, MCASE®, Low Profile JCASE® • Module 6

MATERIAL NUMBER	CATALOG NUMBER	PACK SIZE
ORBOX006Z	RBOX6	
MIC2005.V	MICRO2 Fuse 5A	10
MIC207.5V	MICRO2 Fuse 7.5A	10
MIC2010.V	MICRO2 Fuse 10A	10
MIC2015.V	MICRO2 Fuse 15A	10
MIC2020.V	MICRO2 Fuse 20A	10
MIC2025.V	MICRO2 Fuse 25A	10
MIC3005.V	MICRO3 Fuse 5A	10
MIC307.5V	MICRO3 Fuse 7.5A	10
MIC3010.V	MICRO3 Fuse 10A	10
MCAS020.V	MCASE Fuse 20A	10
MCAS025.V	MCASE Fuse 25A	10
MCAS030.V	MCASE Fuse 30A	10
MCAS040.V	MCASE Fuse 40A	10
LJCA020.V	Low Profile JCASE 20A	10
LJCA025.V	Low Profile JCASE 25A	10
LJCA030.V	Low Profile JCASE 30A	10
LJCA040.V	Low Profile JCASE 40A	10
LJCA050.V	Low Profile JCASE 50A	10
LJCA060.V	Low Profile JCASE 60A	10

MATERIAL NUMBER	CATALOG NUMBER
ORBOX003ZGLO	RBOX3GLO
Contact your local sales manager for more information	

Assortment Kits

Modular Rack Systems

The new MRS Modular Rack System is a flexible offering of fuses that can be ordered based on your needs. Each rack is sold individually and can be locked together to sit on a counter, or wall mounted. They are also available as a complete kit. Size charts, and color identification charts are included to serve as a guide for easy identification and replacement.



0MRS0007ZXA

MATERIAL NUMBER	CATALOG NUMBER	DESCRIPTION	CONTENT
0MRS0001Z	MRS1	ATO Modular Rack System	See Table Below
0MRS0002Z	MRS2	MINI-MAXI Modular Rack System	See Table Below
0MRS0003Z	MRS3	Glass Modular Rack System	See Table Below
0MRS0004Z	MRS4	PAL / MEGA Modular Rack System	See Table Below
0MRS0005Z	MRS5	PAL / JCASE Modular Rack System	See Table Below
0MRS0006Z	MRS6	ATO / MINI Assortments Modular Rack System	See Table Below
0MRS0007Z	MRS7	Complete Modular Rack System - 6 Racks	MRS 1, 2, 3, 4, 5 & 6 - See Table Below
0MRS0007ZXA	MRS7A	Complete Modular Rack System - 7 Racks	MRS 1, 2, 3, 4, 5, 6 & 9 - See Table Below
0MRS0009ZXA	MRS9	ACS / MICRO2 / MICRO3 / MCASE Modular Rack System	See Table Below
0MRS0200Z	MRS200	ATO / MINI / MAXI Modular Rack System	MRS Racks 1 & 2 (Assembled)
0MRS0300Z	MRS300	ATO / MINI / MAXI / Glass Modular Rack System	MRS Racks 1, 2 & 3 (Assembled)

Part Number Contents

MATERIAL NUMBER	0MRS0001Z	0MRS0002Z	0MRS0003Z	0MRS0004Z	0MRS0005Z	0MRS0006Z	0MRS0009ZXA			
CATALOG NUMBER	MRS1	MRS2	MRS3	MRS4	MRS5	MRS6	MRS9			
FUSE TYPE	ATO	MINI / MAXI	GLASS	CERAMIC	PAL / MEGA	PAL	JCASE	ATO / MINI Assortments	MICRO2 / MICRO3	MCASE
CONTENTS	(5) ATO3	(5) MIN2	(5) AGC1	(10) SFE4	(2) PAL20	(1) PAL1120	(1) PAL430	(12) 094202B	(2) MIC2 5	(2) MCAS 15
	(5) ATO4	(5) MIN3	(5) AGC2	(10) SFE7.5	(4) PAL30	(1) PAL230	(1) PAL440	(12) 094362B	(2) MIC2 7.5	(3) MCAS 20
	(10) ATO5	(5) MIN4	(10) AGC3	(10) SFE9	(3) PAL40	(1) PAL240	(1) PAL450		(4) MIC2 10	(2) MCAS 25
	(10) ATO7.5	(10) MIN5	(5) AGC5	(10) SFE14	(3) PAL50	(1) PAL250	(1) PAL480		(4) MIC2 15	(4) MCAS 30
	(15) ATO10	(10) MIN7.5	(5) AGC7.5	(30) SFE20	(2) PAL60	(1) PAL260	(1) PAL4100		(4) MIC2 20	(3) MCAS 40
	(15) ATO15	(15) MIN10	(10) AGC10	(10) SFE30	(1) PAL130	(1) PAL270	(1) PAL525		(3) MIC2 25	
	(20) ATO20	(20) MIN15	(20) AGC15	(10) GBC8	(2) PAL160	(1) PAL280	(1) PAL530		(3) MIC2 30A	
	(10) ATO25	(20) MIN20	(20) AGC20	(10) GBC16	(3) PAL180	(1) PAL2100	(1) JCAS40		(3) MIC3 5	
	(15) ATO30	(15) MIN25	(10) AGC25	(10) GBC25	(2) PAL1100	(1) PAL2120	(1) JCAS50		(3) MIC3 7.5	
	(5) ATO40	(15) MIN30	(30) AGC30		(2) MEG 175	(1) JCAS20	(1) JCAS60		(3) MIC3 10	
		(2) MAX20	(5) AGW15			(2) JCAS30			(3) MIC3 15	
		(3) MAX30	(5) AGW20			(1) PAL330				
		(2) MAX40				(1) PAL340				
		(2) MAX50								
	(3) MAX60									

Circuit Breakers

Type I • Automatic Reset

Cycles or continuously resets until the fault is corrected. Type I circuit breakers are typically used to protect circuits which occasionally experience momentary overloads such as wiper motor and headlamp circuits where a self resetting device is preferred.

Type II • Modified Reset

Non-cycling, remains in open position while there is power to the circuit. Resets when ignition is turned off. Type II circuit breakers are typically used in applications where fuse replacement is objectionable, such as power window, seat and sunroof circuits.

Type III • Manual Reset

Manually resettable circuit breakers remain in the open position until a button, lever or other external reset device is manually depressed. Type III circuit breakers are typically used in applications where a manual reset is desired for safe diagnosis of a circuit fault.

Additional information: Littelfuse.com/CircuitBreakers

MINI® Footprint

Designed to fit in a MINI Blade fuse block or panel. SAE Type II used primarily as a wiring harness protector in 12V DC automotive systems. Conforms to SAE J553C standard.

CURRENT RATING (A)	PART NUMBERS BULK	PART NUMBERS BOXED
10	30419-10	-
15	30419-15	30419-15-BX
20	30419-20	30419-20-BX
25	30419-25	30419-25-BX



Wide MINI® Footprint

Direct factory replacement for many domestic OEM applications. Designed to fit either in an ATO or MINI blade fuse block or panel. Their blade configuration is of the MINI design and fit in a standard ATO fuse slot or across two MINI slots. Available in either SAE Type I cycling or SAE Type II non-cycling used primarily as a wiring harness protector in 12V DC automotive systems. Conforms to SAE J553C standard.

CURRENT RATING (A)	PART NUMBERS BOXED	APPLICATION	CYCLING	NON-CYCLING
15	0MMB015.X	Heavy Truck Headlamp	•	
20	0MMB020.X	Automotive Headlamp	•	
10	0MNB010.X	Heavy Duty Truck		•
15	0MNB015.X	Heavy Duty Truck		•
20	0MNB020.X	Automotive / Heavy Truck		•
25	0MNB025.X	Automotive / Heavy Truck		•
30	0MNB030.X	Automotive / Heavy Truck		•



Specialty OEM ATO® Footprint

Direct factory replacement for many domestic OEM vehicles. SAE Type I and Type II modified reset used primarily as a wiring harness protector in 12V DC automotive systems. Conforms to SAE J553C standard. Designed to mount in ATO style fuse blocks and panels.

CURRENT RATING (A)	BOXED MATERIAL NUMBER	CARDED MATERIAL NUMBER	APPLICATION	OEM PART NUMBER
20	-	0ACB020.XP	Automotive Headlamp	GM: 12040816
30	-	0ACB030.XP	Power Windows & Locks	GM: 01252240
20	0FCB020.X	0FCB020.XP	Power Windows	Ford: 83507005
25	0CCB025.X	0CCB025.XP	Windows, Seats & Locks	Ford: D9AB-14526-BA Chrysler# 4527053



Fuse Clip

Direct replacement for many OEM applications. Designed for glass fuses without physical alteration in the system. Fits 1-1/4" fuse clips. SAE Type II non-cycling used primarily as a wiring harness protector in 12V DC automotive systems. Conforms to SAE J553C standard.

CURRENT RATING (A)	PART NUMBERS BULK	PART NUMBERS BOXED
10	-	30410-10-BX
15	30410-15	30410-15-BX
20	30410-20	30410-20-BX
25	30410-25	30410-25-BX
30	30410-30	30410-30-BX



Circuit Breakers

Universal ATO® Footprint Circuit Breakers

Universal Circuit Breakers function identically and have same internal components as OEM breakers but offer the versatility of snap off terminals for greater flexibility. SAE Type II modified reset used primarily as a wiring harness protector in 12V DC automotive systems. Meets OEM requirements. Conforms to SAE J553C standard. Designed to mount in ATO style fuse blocks and panels.



CURRENT RATING (A)	BOXED MATERIAL NUMBER	BOXED BULK MATERIAL NUMBER	CARDED PACKAGING MATERIAL NUMBER
5	0UCB005.X	BUCB005.Z	0UCB005.XP
10	0UCB010.X	BUCB010.Z	0UCB010.XP
15	0UCB015.X	BUCB015.Z	0UCB015.XP
20	0UCB020.X	BUCB020.Z	0UCB020.XP
25	0UCB025.X	BUCB025.Z	0UCB025.XP
30	0UCB030.X	BUCB030.Z	0UCB030.XP



MAXI Style Circuit Breakers

Direct factory replacement for many domestic OEM applications. Designed to fit a MAXI Blade fuse block or panel. Available in either SAE Type I cycling or SAE Type II non-cycling. Used primarily as a wiring harness protector in 12V DC automotive systems. Meet OEM requirements. Conforms to SAE J553C standard.



CURRENT RATING (A)	BOXED MATERIAL NUMBER	APPLICATION	CYCLING	NON CYCLING
20	0MCB020.X	Automotive Headlamp	•	
30	0MCB030.X	Automotive Headlamp, Seats & Wipers	•	
40	0MCB040.X	-	•	
20	0MXB020.X	Automotive Power Devices Heavy Truck & Auto Cooling Fan		•
30	0MXB030.X	Automotive Power Window Heavy Truck & Auto Cooling Fan & Power Window		•

Circuit Breaker Mounting Brackets & Bus Bars

Mounting brackets available in steel or nylon and accept 30056 and 30137 series breakers. Bus bars are made from heavy solid brass or copper, with holes or slots that make it easy to connect box-type circuit breakers with studs, in order to feed a number of protected circuits.



30090-04 4-gang steel bracket



86099-5 brass busbar with holes



86126-4 copper busbar with slots

PART NUMBERS BULK	PART NUMBERS BOXED	DESCRIPTION	NUMBER OF GANGS	MATERIAL	DIMENSIONS	MOUNTING HOLE DIMENSIONS	NOTES
30090-2	30090-2-BX	Mounting Bracket	2	Steel	.81" x 1.29" (122.2 x 32.8 mm)	4.00" (101.6mm) on centers	For all steel breakers without a bracket. Breakers snap into position, engaging with dimples in the case of the breaker.
30090-3	30090-3-BX		3		5.71" x 1.29" (145.0 x 32.8mm)	1.90" (124.5mm) on centers	
30090-4	30090-4-BX		4		6.62" x 1.29" (160.1 x 32.8mm)	5.81" (147.6mm) on centers	
30090-6	30090-6-BX		6		8.43" x 1.29" (214.1 x 32.8mm)	7.62" (193.5mm) on centers	
30090-8	30090-8-BX		8		10.25" x 1.29" (260.4 x 32.8mm)	9.43" (239.5mm) on centers	
-	86099-2-BX	Busbar	2	Brass	1.53" long (38.9mm)	-	Holes: .910" (23.1mm) on centers, .021" (5.3mm) diameter
86099-3	86099-3-BX		3		2.43" long (61.7mm)	-	
86099-4	86099-4-BX		4		3.34" long (84.8mm)	-	
86099-5	86099-5-BX		5		4.24" long (107.7mm)	-	
86126-2	86126-2-BX		Busbar		2	Cooper	
86126-4	86126-4-BX	4		3.23" x .560" (82.1 x 14.2mm)	2.73" (69.34mm) on centers		
86126-6	86126-6-BX	6		5.05" x .560" (128.3 x 14.2mm)	4.55" (115.57mm) on centers		
86126-8	86126-8-BX	8		6.87" x .560" (174.5 x 14.2mm)	6.37" (161.79mm) on centers		
86126-12	86126-12-BX	12		10.51" x .560" (267.0 x 14.2mm)	10.01" (254.25mm) on centers		

Box Style

Steel or plastic housing. Steel box type is approximately 1 ¼" x ¾" x 2/3" and comes with integral brackets (to be directly affixed with screws or bolts) or without (needs a mounting bracket). Breakers have 10-32 studs, blades or wire leads. Wire lead type has a 10" wire loop connected to studs and PVC-coated. Loop is intended to be cut, stripped and spliced into a circuit.

Additional information: Littelfuse.com/CircuitBreakers



30056, 30137, 30171
with studs, no bracket



30055, 30138, 30172
with studs and bracket



30128
with studs and cross-bracket



3088, 30507
double breaker assembly

Type 1 Steel Case with Stud Terminals

PART NUMBERS BULK	PART NUMBERS BOXED	PART NUMBERS RETAIL	VOLTS	AMPS	SEALED	NOTES
30056-10	30056-10-BX	-	12	10	-	Type 1
30056-15	30056-15-BX	-	12	15	-	
30056-20	30056-20-BX	-	12	20	-	
30056-25	30056-25-BX	-	12	25	-	
30056-30	30056-30-BX	-	12	30	-	
30056-40	30056-40-BX	-	12	40	-	
30056-50	30056-50-BX	-	12	50	-	Type 1 Sealed
30137-10	-	-	12	10	•	
30137-15	30137-15-BX	-	12	15	•	
30137-20	30137-20-BX	-	12	20	•	
30137-30	-	-	12	30	•	Type 1 with bracket
30055-10	30055-10-BX	-	12	10	-	
30055-15	30055-15-BX	30055-15-BP	12	15	-	
30055-20	30055-20-BX	30055-20-BP	12	20	-	
30055-25	30055-25-BX	-	12	25	-	
30055-30	30055-30-BX	30055-30-BP	12	30	-	
30055-40	30055-40-BX	30055-40-BP	12	40	-	
30055-50	30055-50-BX	30055-50-BP	12	50	-	Type I sealed with bracket
30138-10	-	-	12	10	•	
30138-15	-	-	12	15	•	
-	30138-30-BX	-	12	30	•	
30138-40	-	-	12	40	•	Type I with cross-bracket
30128-10	30128-10-BX	-	12	10	-	
30128-15	30128-15-BX	-	12	15	-	
30128-20	30128-20-BX	-	12	20	-	
30128-30	30128-30-BX	-	12	30	-	
30128-40	30128-40-BX	-	12	40	-	

PART NUMBERS BULK	PART NUMBERS BOXED	PART NUMBERS RETAIL	VOLTS	AMPS	SEALED	NOTES
30171-10	30171-10-BX	-	24	10	-	Type 1
30171-15	30171-15-BX	-	24	15	-	
30171-20	30171-20-BX	-	24	20	-	
30171-30	30171-30-BX	-	24	30	-	
30172-10	-	-	24	10	-	Type 1 with bracket
30172-15	30172-15-BX	-	24	15	-	
30172-20	30172-20-BX	-	24	20	-	
30172-30	30172-30-BX	-	12	30	-	
3088-50	-	-	12	50	-	Type 1 Double breaker assembly
3088-60	3088-60-BX	-	12	60	-	
3088-80	3088-80-BX	-	12	80	-	
30507-60	30507-60-BX	-	12	60	•	
30507-80	30507-80-BX	-	12	80	•	Type 1 sealed double breaker assembly

PVC-Coated Steel Case with Wire Terminals



30128
with wire leads with bracket



30063
with wire leads without bracket

PART NUMBERS BULK	PART NUMBERS BOXED	VOLT	AMPS	SEALED	NOTES
-	30062-20-BX	12	20	•	Type 1 with bracket
30062-30	30062-30-BX	12	30	•	
30063-10	-	12	10	•	Type 1
30063-20	30063-20-BX	12	10	•	
30063-30	-	12	30	•	

Stud Type Low Voltage (6-12V DC)

SAE Type I automatic reset provides protection in installations where it is not possible to manually reset a breaker because of location or safety requirements. Used primarily as a wiring harness protector in 12V DC automotive systems. Conforms to SAE J553C standard. Available with or without mounting bracket.

CURRENT RATING (A)	BOXED WITHOUT BRACKET MATERIAL NUMBER	BOXED WITH BRACKET MATERIAL NUMBER	CARDED MATERIAL NUMBER
5	0812005.ZXST	0813005.ZXST	-
6	0812006.ZXST	-	-
8	-	0813008.ZXST	-
10	0812010.ZXST	0813010.ZXST	-
15	0812015.ZXST	0813015.ZXST	-
20	0812020.ZXST	0813020.ZXST	0813020.XP
25	0812025.ZXST	0813025.ZXST	-
30	0812030.ZXST	0813030.ZXST	0813030.XP
40	0812040.ZXST	0813040.ZXST	0813040.XP
50	0812050.ZXST	0813050.ZXST	0813050.XP



Circuit Breakers

50-150A · 32V DC · Hi-Amp Type III

These high amp circuit breakers are typically used in auxiliary and accessory circuits for trucks, buses, RVs and marine applications in battery charger systems and DC audio systems. All high amp circuit breakers comply with the SAE J1117 and J1625 standard for ignition protection.

- Agency Approvals: UL Approved for all amp ratings at 32V DC
- Interrupting Rating: 3000A @30V DC
- Ignition Protection: SAE J1625 and J1171
- Material: Thermoset Plastic UL Rating 94VO
- Temperature Range: -32C to 92C
- RoHS Compliant
- Waterproof



CURRENT RATING (A)	BOXED PART NUMBERS MATERIAL NUMBER	BOXED PART NUMBERS CATALOG NUMBER	CARDERD PART NUMBERS MATERIAL NUMBER	CARDERD PART NUMBERS CATALOG NUMBER	INTERRUPTING RATING	RoHS
50	0185050.X	185050	-	-	3000A @ 30V DC	•
60	0185060.X	185060	-	-	3000A @ 30V DC	•
70	0185070.X	185070	-	-	3000A @ 30V DC	•
80	0185080.X	185080	-	-	3000A @ 30V DC	•
100	-	-	0185100.XP	185100BP	3000A @ 30V DC	•
120	-	-	0185120.XP	185120BP	3000A @ 30V DC	•
150	-	-	0185150.XP	185150BP	3000A @ 30V DC	•

Mini® Type 1

Designed to fit in a MINI blade fuse block or panel. Conforms to SAE J553. Cycles or continuously resets until the fault is corrected. Type I circuit breakers are typically used to protect circuits which occasionally experience momentary overloads such as wiper motor and headlamp circuits where a self resetting device is preferred.

CURRENT RATING (A)	CARDERD PART NUMBERS MATERIAL NUMBER	CARDERD PART NUMBERS CATALOG NUMBER
10	0211010.XP	211010BP
15	0211015.XP	211015BP
20	0211020.XP	211020BP
25	0211025.XP	211025BP
30	0211030.XP	211030BP



ATO® Type 1 Automatic Reset

Circuit breakers and fuses are a cost-effective solution to protecting wiring, equipment and subsystems. Terminals are grooved so that they can be easily snapped off with pliers to fit the electrical blocks of different vehicles. Use as is (long terminals) for Kenworth trucks. Use with one segment snapped off each terminal for: Dodge trucks, Ford heavy trucks, Navistar trucks. Use with two segments snapped off (short terminals) for Ford pickup trucks. Color-coded housings with rating marked on the top: 10A red, 15A blue, 20A yellow, 25A silver, 30A green.

CURRENT RATING (A)	PART NUMBERS BULK	PART NUMBERS BOXED	PART NUMBERS RETAIL CLAMSHELL	COLOR
10	30409-10	30409-10-BX	-	Red
15	30409-15	30409-15-BX	-	Blue
20	30409-20	30409-20-BX	30409-20-BP	Yellow
25	30409-25	30409-25-BX	-	Silver
30	30409-30	30409-30-BX	30409-30-BP	Green

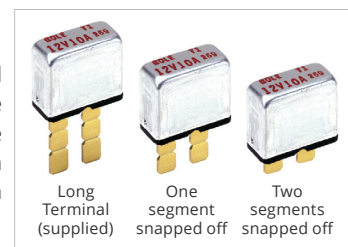

Fuse Blocks, Holders & Terminal Blocks



Fuse Holders accept fuses to provide electrical protection on circuits. In the following section, there is a wide range of fuse holders from lower current to higher current ratings and in various levels of sealing from moisture and dust.

Where Do I Need a Fuse Holder?

Fuse holders allow you to install a fuse into an electrical circuit to protect the wiring from the harmful effects of excessive amount of electricity flowing through the cables. The fuse is a replaceable element that will blow to stop the flow of an overload of electricity. If a fuse blows in a circuit, it is important to understand what caused the issue before replacing the fuse, otherwise there is a risk of repeated failures.

Fuses (in fuse holders) should be placed on every wire, as close to the point of the source of power (the battery) as possible. Every time a wire is split or spliced into smaller wires, each of those should be fused. Single fuse holders protect a single wire. A fuse (holder) should be properly sized. Larger diameter wires require larger fuses and smaller diameter wires get smaller rated fuses. Refer to best practices for proper selection fuses for your system.

Sealed or Unsealed

Depending where on the vehicle a fuse holder is placed, it may be wise to utilize sealed fuse holders. In all instances, it is advisable to try to have the most amount of physical protection of the fuse/fuse holder combination that makes sense. Fuse holders may have simple coverings to prevent accidental shorting, all the way to completely sealing the fuse and cable to provide protection from moisture and dust in the electrical system. The more exposure to impurities the more risk to the safe and efficient performance of the electrical system as these elements can cause corrosion, and even electrical faults and failures. Some environments however are protected and it may not be necessary to use a sealed fuse holder. Littelfuse offers a wide variety of fuse holders that range from open to fully sealed.

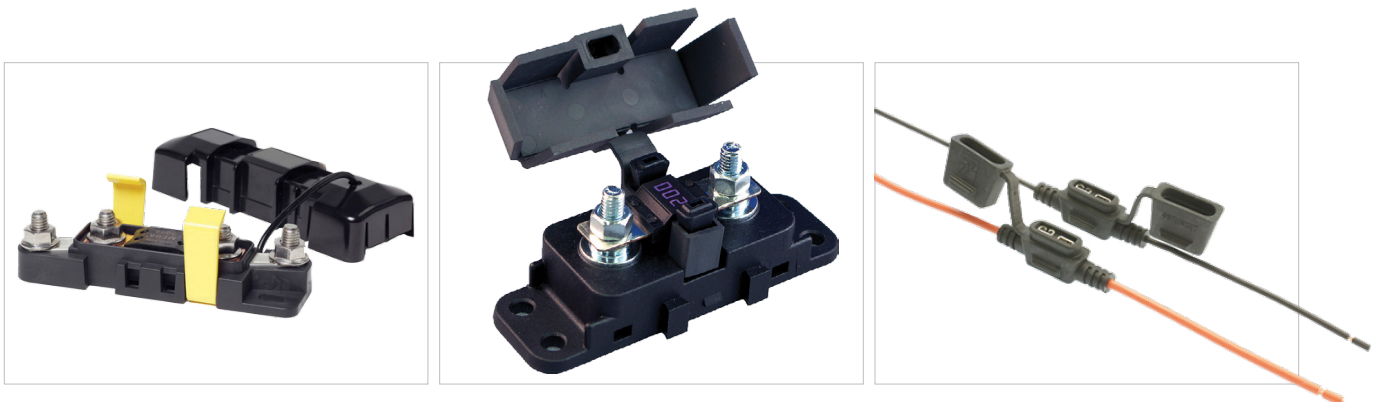

Bolt-Down Fuse Blocks

SD ATO® Series **NEW**

SD ATO® Fuse Blocks provide a cost effective, consolidated circuit protection solution. Designed to accept standard ATO® fuses, these products ensure the safe distribution of power throughout an application. Integrated LED blown fuse indicators allow for quick maintenance, preventing troubleshooting & equipment downtime. These products are RoHS compliant. Fuses sold separately.

Additional information: Littelfuse.com/SD-ATO

PART NUMBERS BULK	MATERIAL NUMBERS CARDED	DESCRIPTION	VOLTS	CURRENT RATING
880021	880021-BP	4 ATO® Fuse Block with LED	32V DC	100A
880022	880022-BP	6 ATO® Fuse Block with LED	32V DC	100A
880023	880023-BP	10 ATO® Fuse Block with LED	32V DC	100A



SD MINI® Series **NEW**

SD MINI® Fuse Blocks provide a cost effective, consolidated circuit protection solution. Designed to accept standard MINI® fuses, these products ensure the safe distribution of power throughout an application. Integrated LED blown fuse indicators allow for quick maintenance, preventing troubleshooting & equipment downtime. These products are RoHS compliant. Fuses sold separately.

Additional information: Littelfuse.com/SD-MINI

PART NUMBERS BULK	MATERIAL NUMBERS CARDED	DESCRIPTION	VOLTS	CURRENT RATING
880024	880024-BP	4 MINI® Fuse Block with LED	32V DC	100A
880025	880025-BP	6 MINI® Fuse Block with LED	32V DC	100A
880026	880026-BP	10 MINI® Fuse Block with LED	32V DC	100A



ST ATO® Series **NEW**

ST ATO® Fuse Blocks provide a cost effective, consolidated circuit protection solution. Designed to accept standard ATO® fuses, these products ensure the safe distribution of power throughout an application. These products are RoHS compliant. Fuses sold separately.

Additional information: Littelfuse.com/ST-ATO

PART NUMBERS BULK	MATERIAL NUMBERS CARDED	DESCRIPTION	VOLTS	CURRENT RATING
880027	880027-BP	6 ATO® ST Fuse Block with Ground	32V DC	100A
880028	880028-BP	12 ATO® Fuse Block with LED	32V DC	100A



MEGA® 298 Series

Use with MEGA® fuses up to 500A. Ideal for battery and alternator connections and other heavy gauge cables requiring ultra high current protection. Includes protective cover. Features interconnecting pins on side of fuse block for multiple block configurations. Includes M8 threaded studs and hex nuts with lock washers. Fuse not included. Additional information: Littelfuse.com/298

PART NUMBERS BULK 70 PIECE	PART NUMBERS BULK 20 PIECE	PART NUMBERS BULK 10 PIECE	VOLTS	AMPS	HARDWARE MATERIAL	STUD TORQUE
02980900Z	02980900S	02980900TXN	32V DC	500A	Zinc-Plated Steel	12-18 Nm



Bolt-Down Fuse Blocks

FHZ Series • 400A • Power Distribution Module

The 5 Stud ZCASE® Fuse Holder uses a single power input (usually with a ZCASE® shunt) and a common busbar to feed up to 4 additional ZCASE® fused circuits. Freely interchangeable ZCASE® fuse ratings; configurable stud size (M6, M8, or M10); and available 2-, 3-, 4-, or 5-position busbars allow for a wide range of possible configurations. **Additional information:** Littelfuse.com/5StudZCASE

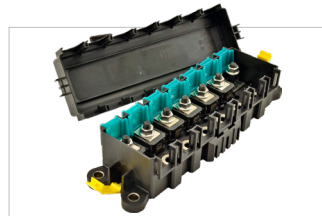

PART NUMBERS	DESCRIPTION	AMPS	MAX FUSE RATING	FULL ASSEMBLY	DIMENSIONS
0FHZ0001Z	Five-Stud Fuse Box with M10 Input & M8 Outputs	400A	40-600A	-	217mm x 86mm x 59mm
0FHZ0002Z	Five-Stud Fuse Box with M10 Input & M8 Outputs			•	
0FHZ0003Z	Fuse Box Only for Five-Stud Configuration			-	
0FHZ0005Z	Five-Stud Fuse Box with M8 Studs			•	281mm x 58.55mm x 85.7mm
0FHZ0006Z	Seven-Stud Fuse Box with M8 Studs			-	
0FHZ0007Z	Seven-Stud Fuse Box with M8 Studs			•	
0FHZ0008Z	Fuse Box Only for Seven-Stud Configuration			-	
0FHZ0009Z	even-Stud Fuse Box with Seven Fuses & Input Shunt			-	

MEGA® SN Series Assure-Latch™

The SN Series is a high amperage in-line MEGA® fuse block with sealed positive latching technology. The fuse holder base and cover are secured together with AssureLatch™ technology to form a water resistant and ignition protected assembly. Fuse not included.



Additional information: Littelfuse.com/SN

PART NUMBERS	VOLTS	AMPS	INGRESS	HARDWARE MATERIAL	STUD TORQUE	NOTES
880014	32V DC	500A	IP66 & IP69K	Tin-Plated Steel	20 Nm	Ignition Protected

* More options available, visit our website for a complete listing.

MEGA® Flex Series

For use with MEGA® bolt-down fuses, up to 500A. The Flex holder offers a flexible cover, which allows cable entry from virtually any direction, large wire size, and ring terminal stack up. Busbars are available for multiple holder applications and a dovetail feature allows interlocking of multiple Flex-MIDI® and Flex-MEGA® fuse holders together for a power distribution block. Fuse not included.

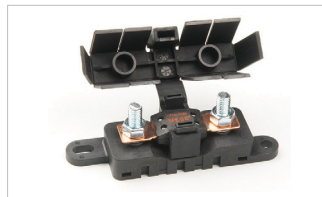

Additional information: Littelfuse.com/FLEX-MEGA

PART NUMBERS	MATERIAL NUMBER CARDED	VOLTS	AMPS	HARDWARE MATERIAL	STUD TORQUE	NOTES
02981001ZXT	-	32V DC	500A	Zinc-Plated Steel	12-18 Nm	330 Piece
02981028HXFC-SS	-	32V DC	500A	Stainless Steel	12-18 Nm	-
02981028HXFC	02981028-BP	32V DC	500A	Zinc-Plated Steel	12-18 Nm	-

BUSBAR PART NUMBERS	DESCRIPTION	HARDWARE MATERIAL	NOTES
882-839-2	2 Position Bus Bar	Tin-Plated Copper	For use 2 Fuse Holders
882-839-3	3 Position Bus Bar	Tin-Plated Copper	For use 3 Fuse Holders
882-839-4	4 Position Bus Bar	Tin-Plated Copper	For use 4 Fuse Holders
882-839-5	5 Position Bus Bar	Tin-Plated Copper	For use 5 Fuse Holders

MIDI® 498/498-IL Series

Use with MIDI® fuses up to 200 amps. Includes protective cover. Features interconnecting pins on side of fuse block for multiple block configurations. Includes M5 threaded studs and hex nuts with lock washers. Fuse not included. **Additional information:** Littelfuse.com/MIDI-498-IL



PART NUMBERS BULK 10 PIECE	PART NUMBERS BULK 20 PIECE	PART NUMBERS BULK 330 PIECE	CARDED MATERIAL NUMBER RETAIL	DETAILS	AMPS	HARDWARE MATERIAL
04980921GXM5	049809005	04980900ZXT	-	Complete Assembly	200A	Zinc-Plated Steel
-	-	04980903ZXT	04980903-BP	Holder with mounting brackets	200A	Zinc-Plated Steel
-	-	04980904ZXT	-	Includes protective cover, threaded M5 studs, split washers, and hexnuts	200A	Zinc-Plated Steel

Bolt-Down Fuse Blocks

MIDI® Flex Series

For use with MIDI® bolt-down fuses, up to 200A. The Flex holder offers a flexible cover, which allows cable entry from virtually any direction, large wire size, and ring terminal stack up. Busbars are available for multiple holder applications and a dovetail feature allows interlocking of multiple Flex-MIDI® and Flex-MEGA® fuse holders together for a power distribution block. Fuse not included.



Additional information: Littelfuse.com/FLEX-MIDI

PART NUMBERS	MATERIAL NUMBER CARDED	VOLTS	AMPS	HARDWARE MATERIAL	STUD TORQUE	NOTES
04981038HXFC	04981038-BP	32V DC	200A	Zinc-Plated Steel	3.0-5.0 Nm	-
04982001ZXFC	-	32V DC	200A	Zinc-Plated Steel	3.0-5.0 Nm	2 Holders with Busbar

BUSBAR PART NUMBERS	DESCRIPTION	HARDWARE MATERIAL	NOTES
882-267-002	2 Position Bus Bar	Tin-Plated Copper	For use 2 Fuse Holders
882-267-003	3 Position Bus Bar	Tin-Plated Copper	For use 3 Fuse Holders
882-267-004	4 Position Bus Bar	Tin-Plated Copper	For use 4 Fuse Holders
882-267-005	5 Position Bus Bar	Tin-Plated Copper	For use 5 Fuse Holders

In-Line Fuse Holders

MAXI® Blade Splash Resistant • 152 Series

The In-line Splash Resistant Fuse Holder provides an efficient, simple installation method for MAXI fuse applications in harsh under-the-hood environments.

Additional information: Littelfuse.com/152

BOXED PART NUMBER	DETAILS	AMPS	INGRESS	KIT CONTENTS SEALS	KIT CONTENTS TERMINALS	KIT CONTENTS COVER
01520003TXN941	for 4-6mm ² wire	60A	IP54	•	•	•
01520003TXN942	for 6-10mm ² wire	60A	IP54	•	•	•
01520005Z	Body with tabs	60A	IP54	-	•	•
01520006Z	Body without tabs	60A	IP54	-	•	•



MAXI® • MAH Series

Use with MAXI® Fuse up to 60 amps. Supplied with two 6" wire leads of 6 gauge black wire. Includes protective cover for harsh environment and mounting hole for easy firewall installation.

Additional information: Littelfuse.com/MAH

BOXED PART NUMBER	BOXED PART NUMBER CATALOG NUMBER	MATERIAL NUMBERS CARDED	DETAILS	AMPS	INGRESS	WIRE DETAILS GAUGE	WIRE DETAILS LENGTH	WIRE DETAILS COLOR	COVER
MAHC0001ZXJ	MAH1	MAHC-BP	Standard	up to 60A	IP67	6	5"	Black	•
MAHC0001ZXJA	-	-	Standard	up to 60A	IP67	6	5"	Red	•
MAHC0001TXJ	-	-	Standard	up to 60A	IP67	6	5"	Black	•



In-Line Fuse Holders

MAXI® • MAB Series

Use with MAXI® fuses up to 60 amps. Safe/easy replacement for hard to replace fusible link wire. Perfect for high amp audio applications. Interlocking block feature permits two pole position installation. Contains screw terminals. Optional dust cover available (Part Number: 01520007Z).

Additional information: Littelfuse.com/MAB

PART NUMBERS BULK	PART NUMBERS BOXED	PART NUMBERS CARDED	DETAILS	AMPS	COVER
OMAB0001S	OMAB0001F	OMAB0001XP	High Amp	up to 60A	01520900TXN (Sold Separately)



Sealed ATO® and MINI® Series NEW

Sealed In-line ATO® and MINI® fuse holders are designed to allow easy installation of fusing into potentially wet or dirty environments outside of the cab. Use with ATO® fuses 1-30A or MINI® fuses 2-30A. Comes with twin 8" red GXL wire leads for easy in-line installation.

- Rated IP67 with sealed cover for moisture & dust resistance
- Includes two 8" Red GXL wire leads for easy in-line installation

Additional information: Littelfuse.com/SealedATO-MINI

PART NUMBERS	MATERIAL NUMBERS CARDED	FUSE TYPE	VOLTS	CURRENT	WIRE DETAILS GAUGE
FHAS100	FHAS100-BP	ATO®	32V DC	20-30A	12
FHAS101	-				14
FHMS200	FHMS200-BP	MINI®			12
FHMS201	-				14



MINI® • FHM Series

Use with MINI® 2 to 20A fuses. Supplied with two 4" wire leads of 14 gauge black wire. Includes protective cover for harsh environment. Heavy Duty MINI® In-line Blade Fuse Holders with Covers - FHM Series: Use with MINI® 25 and 30A fuses. Supplied with two 4" wire leads of 12 gauge orange wire. Includes protective cover for harsh environment.

Additional information: Littelfuse.com/FHM

PART NUMBERS BULK 20 PIECE	PART NUMBERS CARDED MATERIAL NUMBER	PART NUMBERS CARDED CATALOG NUMBER	DETAILS	AMPS	INGRESS	WIRE DETAILS GAUGE	WIRE DETAILS LENGTH	WIRE DETAILS COLOR	COVER
0FHM0001SXJ	0FHM0001XP	FHM1BP	Standard	2-20A	IP67	14	4"	Black	•
0FHM0002SXJ	0FHM0002XP	FHM2BP	Heavy Duty	25-30A	IP67	12	4"	Orange	•
-	0FHM0001XPGL0	20-1020	Smart Glow	2-20A	IP67	14	4"	Red	•



* Please inquire about additional bulk quantities

In-Line Fuse Holders

ATO® - FHM Series

Use with ATO® 1 to 20A fuses. Supplied with two 3.5" wire leads of 16 gauge black wire. Includes protective cover for harsh environment. Heavy Duty ATO® In-line Blade Fuse Holders with Covers - FHAC Series: Use with ATO® 25 and 30A fuses for air conditioner or other heavy duty applications. Supplied with two 3.5" wire leads of 12 gauge orange wire. Includes protective cover for harsh environment.



Additional information: Littelfuse.com/FHAC

PART NUMBERS BULK 20 PIECE	PART NUMBERS CARDED MATERIAL NUMBER	PART NUMBERS CARDED CATALOG NUMBER	DETAILS	AMPS	INGRESS	WIRE DETAILS GAUGE	WIRE DETAILS LENGTH	WIRE DETAILS COLOR	COVER
FHAC0001SXJ	FHAC0001XP	FHAC1BP	Standard	2-20A	IP67	16	3.5"	Black	•
FHAC0002SXJ	FHAC0002XP	FHAC2BP	Heavy Duty	25-30A	IP67	12	3.5"	Orange	•

* Please inquire about additional bulk quantities



ATO® - FHA Series

Use with ATO® 1 to 20A fuses. Supplied with two 4" wire leads of 16 gauge black wire. Heavy Duty ATO® In-line Blade Fuse Holders - FHA Series: Use with ATO® 25 and 30A fuses for air conditioner or other heavy duty applications. Supplied with two 4" wire leads of 12 gauge orange wire. FHA30BP includes 30 amp fuse.



Additional information: Littelfuse.com/FHA

PART NUMBERS BULK 20 PIECE	PART NUMBERS CARDED MATERIAL NUMBER	PART NUMBERS CARDED CATALOG NUMBER	PART NUMBERS BOXED MATERIAL NUMBER	PART NUMBERS BOXED CATALOG NUMBER	DETAILS	AMPS	WIRE DETAILS GAUGE	WIRE DETAILS LENGTH	WIRE DETAILS COLOR
0FHA0001SXJ	0FHA0001XP	FHA1BP	-	-	Standard	2-20A	16	4"	Black
0FHA0002SXJ	0FHA0002XP	FHA2BP	-	-	Heavy Duty	25-30A	12	4"	Orange
-	0FHA0030XP	FHA30BP	0FHA0030Z	FHA30	Heavy Duty with 30A Fuse	25-30A	12	4"	Orange
-	0FHA0001XPGL0	20-1010	-	-	Smart Glow	-	12	4"	Red

* Please inquire about additional bulk quantities



ATO® - Panel Mount - AFH and 155 Series

Versatile fuse holder for in-line or snap mount panel applications. Interlock body design allows fuse holders to be snapped together. Supplied with 8" loop of 14 gauge black wire. Heavy Duty ATO® In-line Panel Mount Blade Fuse Holders - AFH and 155 Series: Use with ATO® 25 and 30A fuses. Supplied with 8" loop of 10 gauge orange wire.



Additional information: Littelfuse.com/AFH

PART NUMBERS BOXED MATERIAL NUMBER	PART NUMBERS BOXED CATALOG NUMBER	PART NUMBERS CARDED MATERIAL NUMBER	PART NUMBERS CARDED CATALOG NUMBER	DETAILS	AMPS	WIRE DETAILS GAUGE	WIRE DETAILS LENGTH	WIRE DETAILS COLOR
-	-	0AFH0001XP	AFH1BP	Standard	1-20A	14	8" loop	Black
-	-	0AFH0002XP	AFH2BP	Heavy Duty	25-30A	10	8" loop	Orange
01550300Z	155300	-	-	Standard	20A	14	8" loop	Black

* Please inquire about additional bulk quantities



JCASE and Glass Fuse Holders

JCASE® In-line Cartridge • FHJC and FHJ Series

In-line fuse holders for JCASE® fuses available with brackets covers or wire sizes 10AWG (up to 40A) or 8AWG (up to 60A). **Additional information:** Littelfuse.com/FHJC



PART NUMBERS BULK 250 PIECE	PART NUMBERS BULK 50 PIECE	DETAILS	AMPERAGE	INGRESS	WIRE DETAILS GAUGE	WIRE DETAILS LENGTH	WIRE DETAILS COLOR	BRACKET	COVER
FHJC1001G	-	Standard	up to 40A	IP67	10AWG	4"	Red	-	•
FHJC1002G	FHJC1002L	Heavy Duty	up to 60A	IP67	8AWG	4"	Red	-	•
FHJC2002G	FHJC2002L	Heavy Duty	up to 60A	IP67	8AWG	4"	Red	•	•
0FHJ1001G	-	Standard	up to 40A	-	10AWG	4"	Red	-	-
0FHJ1002G	-	Heavy Duty	up to 60A	-	8AWG	4"	Red	-	-
0FHJ2001G	-	Standard	up to 40A	-	10AWG	4"	Red	•	-
0FHJ2002G	-	Heavy Duty	up to 60A	-	8AWG	4"	Red	•	-

* Please inquire about additional bulk quantities

Glass Fuse In-line Twist-Lock • FNY Series

Constructed of weather resistant nylon. Simple "twist-lock" allows easy fuse removal and replacement. Supplied with 8" loop of 14 gauge black wire and one spring. Use with Glass SFE 4, 6, 7 1/2, 9, 14, 20, AGA, AGC, AGW and AGX Fuses up to 20 amps.

Additional information: Littelfuse.com/FNY



CARDER PART NUMBERS MATERIAL NUMBER	CARDER PART NUMBERS CATALOG NUMBER	DETAILS	AMPS	WIRE DETAILS GAUGE	WIRE DETAILS LENGTH	WIRE DETAILS COLOR
0FNY0001XP	FNY1BP	Holder Only	up to 20A	14	8" loop	Black

* Please inquire about additional bulk quantities

Glass Fuse In-line Heavy Duty • FNY Series

Spring loaded heavy duty glass fuse holder includes AGC 20A or 30A fuse for GM air conditioner, heater blower motors or other heavy duty applications. Supplied with two 4" wire leads of 12 gauge orange wire. FNY20BP includes 20A fuse, FNY30BP includes 30A fuse.

Additional information: Littelfuse.com/FNY



CARDER PART NUMBERS MATERIAL NUMBER	CARDER PART NUMBERS CATALOG NUMBER	DETAILS	AMPS	WIRE DETAILS GAUGE	WIRE DETAILS LENGTH	WIRE DETAILS COLOR
0FNY0020XP	FNY20BP	With 20A Fuse	20A	12	4"	Orange
0FNY0030XP	FNY30BP	With 30A Fuse	30A	12	4"	Orange

* Please inquire about additional bulk quantities

Glass Fuse In-line Bayonet Knob • FHP Series

Constructed of tough black thermoset (UL94V0). Includes 3 springs for various fuse sizes and spring-locked, bayonet type knob. Supplied with 15" loop of 14 gauge red wire. Use with Glass SFE 7 1/2, 9, 14, 20, AGA, AGC, AGW and AGX Fuses up to 20 amps.

Additional information: Littelfuse.com/FHP



BOXED PART NUMBERS MATERIAL NUMBER	BOXED PART NUMBERS CATALOG NUMBER	DETAILS	AMPS	WIRE DETAILS GAUGE	WIRE DETAILS LENGTH	WIRE DETAILS COLOR
0FHP0001Z	FHP1	Holder Only	up to 20A	14	15" loop	Red

3AG Shock-Safe Panel Mount

Designed to eliminate the possibility of electrical shock, as defined in IEC standards 65 and 257. Shock-Safe fuse holders feature a low profile body, finger-grip knob and anti-tease feature that eliminates circuit interruption when knob is accidentally depressed.

CARDER MATERIAL NUMBER	VOLTS	AMPS	TERMINALS
03453LF2XP	250 V	20A	1/4" straight NEMA/DIN quick connect



Add-A-Circuit® and Power Feed

ATO®

Allows easy installation of additional circuits without cutting or splicing. Turns one fuse slot into two while providing protection for both circuits. Maintains new car warranty. Use with ATO® Fuses up to 10 amps. Includes ATO® 3, 5, 7.5 and 10 amp fuses.

BOXED PART NUMBERS MATERIAL NUMBER	BOXED PART NUMBERS CATALOG NUMBER	CARDED PART NUMBERS MATERIAL NUMBER	CARDED PART NUMBERS CATALOG NUMBER
0FHA0200Z	FHA200	0FHA0200ZP	FHA200BP



MINI®

Same as ATO® Add-A-Circuit except for use with MINI® Fuses up to 10 amps. Includes MINI® 3, 5, 7.5 and 10 amp fuses.

BOXED PART NUMBERS MATERIAL NUMBER	BOXED PART NUMBERS CATALOG NUMBER	CARDED PART NUMBERS MATERIAL NUMBER	CARDED PART NUMBERS CATALOG NUMBER
0FHM0200Z	FHM200	0FHM0200ZP	FHM200BP



LP MINI®

Same as ATO® Add-A-Circuit except for use with LP MINI® Fuses up to 10 amps. Includes LP MINI® 3, 5, 7.5 and 10 amp fuses.

BOXED PART NUMBERS MATERIAL NUMBER	CARDED PART NUMBERS MATERIAL NUMBER
FHLM0200Z	FHLM0200ZPA



MICRO2®

Same as ATO Add-A-Circuit except for use with MICRO2® Fuses up to 10 amps. Includes MICRO2® 3, 5, 7.5 and 10 amp fuses.

BOXED PART NUMBERS MATERIAL NUMBER	CARDED PART NUMBERS MATERIAL NUMBER
FHM20200Z	FHM20200ZPA



Battery Power Feed Kit

Attaches directly to battery terminal. Allows the addition of up to 3 circuits. Includes MINI® fuse in-line fuse holder with protective cap. Also can be used as a frame ground. Constructed of durable brass for optimal conductivity.

CARDED PART NUMBERS MATERIAL NUMBER	CARDED PART NUMBERS CATALOG NUMBER
0BPF0001ZP	BPF1BP



Caution: Fusetaps are not a recommended alternative for adding circuits because they can stress the terminals in the fuse block. This situation can create a loose fitting fuse, which in turn produces excessive heat, which can cause nuisance blows, even melting of the fuse and fuse block and possibly an expensive repair in the future. When a fusetap is used, in many cases there is no fuse protecting the new circuit, a condition which can also present a hazard.

Fuse Pullers and Battery Accessories

Fuse Tester and Puller

Conveniently and easily tests ATO® and MINI® blade fuses either in or out of the fuse block, with or without vehicle battery power. Indicator light on tester glows bright green when fuse is good. Fuse puller end allows for easy fuse removal and replacement. 24V maximum.

Fuse Pullers

Fuse puller allows for easy fuse removal and replacement.

BOXED PART NUMBERS MATERIAL NUMBER	BOXED PART NUMBERS CATALOG NUMBER	CARDERD PART NUMBERS MATERIAL NUMBER	CARDERD PART NUMBERS CATALOG NUMBER	DESCRIPTION
00970019X	097019	00970019XP	097019BP	ATO® & MINI® Fuse Puller / Tester
-	097023	00970023XP	097023BP	Tri-Puller™ – Glass Fuses, Ceramic Type Fuses, ATO® and MINI® Blade Fuse Puller
-	097026	00970026XP	097026BP	MAXI® Blade Fuse Puller
-	097038	00970038XPA	-	ATO® and MINI® Fuse Puller
-	-	00970053XP	-	JCASE® Fuse Puller
-	-	00970025XPA	-	MICRO2® / MICRO3® Fuse Puller
-	-	00970054XPA	-	MCASE® Fuse Puller



Anti-Theft Battery Master Switch

- Available in two versions, Fused and Detachable.
- Fused version maintains current to all electrical circuits such as the alarm, on-board computer, central locking system and radio memory presets.
- Detachable version features a special disconnect that allows the battery to easily be removed for anti-theft protection. Perfect for seasonal storage needs or easy off vehicle battery charging for Autos, Motorcycles, RV's, Boats, etc.
- Generate sales with the lowest cost anti-theft devices available on the market today.
- A simple turn of the knob isolates the battery and makes the vehicle unable to start.
- Makes anti-theft protection affordable when compared to expensive alarm systems.
- Eliminates complicated installation — no special electrical or mechanical expertise required.
- Fits all standard Top Mount Post batteries. Can be used with Side Mount Post batteries by using a Top Mount Adapter Post (not included).
- Works on 12 to 24 volt systems up to 135 amperes.



CARDERD PART NUMBERS MATERIAL NUMBER	CARDERD PART NUMBERS CATALOG NUMBER	DESCRIPTION
0ATD0300ZBP	ATD300BP	Anti-theft Battery Master Switch – Fused

Multiple Position Fuse Blocks

SMZ Series • Stud Mount ZCASE® Fuse Holder

The SMZ stud mount fuse holder allows you to mount fusing directly to a M8 or M10 stud on applications such as batteries, alternators, battery switches or electrical relays.

- Mounts directly to a M10 or M8 stud
- Uses high amp ZCASE fuses, (M8) available 40-600A
- Tin plate coating on the busbar ensures corrosion resistance

Additional information: Littelfuse.com/SMZ

PART NUMBERS	MOUNTING SIZE	FUSE TERMINAL NUT (M8)	DETAILS
0FHZ0201Z	M8 (8.5mm)	•	901-525 Fuse / Stud Cover
0FHZ0202Z	M8 (8.5mm)	•	901-524 Fuse Cover
0FHZ0211Z	M10 (10.5mm)	•	901-525 Fuse / Stud Cover
0FHZ0212Z	M10 (10.5mm)	•	901-524 Fuse Cover



Multiple Position Fuse Blocks

Battery Mount ZCASE® Fuse Holders

The Battery Mount ZCASE® Fuse Holders offer a straightforward solution by enabling direct mounting to post-style battery terminals, streamlining circuit protection. This compact design, featuring an integrated busbar, reduces the complexity of wiring around the battery system, cutting down on additional wiring needs. Operating with fuse ratings up to 400A and available in 2-, 3-, and 4-position configurations, it serves as a scalable circuit protection solution.

Additional information: Littelfuse.com/BMZ • Littelfuse.com/BMZB • Littelfuse.com/BMZS



PART NUMBERS	SERIES	POSITION	DESCRIPTION
FHZ00861	BMZS	1	80V Forged Battery-Mounted Base, Insulated M10 Stud, and Cover
FHZ00862	BMZS	2	80V Forged Battery-Mounted Base, Positive Battery Post, 2 Insulated M10 Studs, and Cover
FHZ00863	BMZS	3	80V Forged Battery-Mounted Fuse Holder Base, 3 Insulated M10 Bolts, and Cover
FHZ210	BMZB	2	32V Battery Mount ZCASE® With Busbar Fuse Holder, - Position
FHZ310	BMZB	3	32V Battery Mount Fuse Holder
FHZ410	BMZB	4	32V Battery Mount Fuse Holder
0FHZ00852	BMZ	1	32V Bolt-Down ZCASE® BMZ Series Fuse Holder Left-Hand Terminal Mount
0FHZ00853-BX	BMZ	3	32V Bolt-Down ZCASE® BMZ Series 3-Way Fuse Holder Kit
0FHZ00854-BX	BMZ	2	32V Bolt-Down ZCASE® BMZ Series 2-Way Fuse Holder Kit
908-082	BMZS	-	M10 Insulated Stud for ZCASE®
901-731	BMZS	-	Cover for 1-Position Forged Battery-Mounted ZCASE® Fuse Holder
901-730	BMZS	-	Cover for 2- and 3-Position Forged Battery-Mounted ZCASE® Fuse Holder
876-199	BMZ	-	32V Bolt-Down ZCASE® BMZ Series Fuse Holder Right-Handed Terminal Mount
882-853	BMZ	3	32V Bolt-Down ZCASE® BMZ Series Fuse Holder 3-Way Busbar & Stud Assembly
882-854	BMZ	2	32V Bolt-Down ZCASE® BMZ Series Fuse Holder 2-Way Busbar & Stud Assembly
901-325	BMZ	-	ZCASE® BMZ Series Fuse Holder Red Rubber Cover

4P-5P Series • ZCASE® Fuse Holder **NEW**

ZCASE® 4P-5P Series 400A Bolt-Down Fuse Holders are four-position and five-position automotive fuse blocks that enable circuit-protected power distribution with ZCASE® fuses (sold separately). These DC power distribution blocks have thermoplastic bases and protective covers with UL 94 V-0 flammability ratings and have been tested to ISO 16750-3 standards for shock and vibration.

Additional information: Littelfuse.com/4P-5Pseries

PART NUMBERS BULK	POSITION	VOLTS	DESCRIPTION
FHZ416	4	32V	400A Four-Position Bolt-Down Fuse Holder Base and Cover
FHZ415	5	80V	400A Five-Position Bolt-Down Fuse Holder Base
FHZ515	-	-	Five-Position Fuse Holder Cover

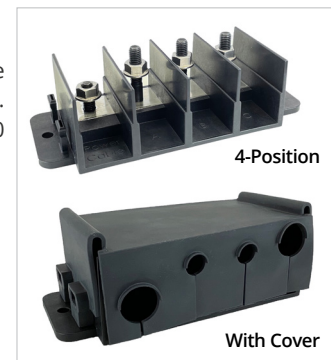

Sealed ZCASE® • IP69K Bolt Down Fuse Holder **NEW**

The Sealed ZCASE® Fuse Holder Series is a versatile and rugged electrical distribution solution designed to provide medium-amp and high-amp circuit protection and terminal connections for up to 6 ZCASE® fuses. This series is characterized by its sealed design, ensuring protection against environmental conditions, and its ease of installation with secure latching mechanisms.

Additional information: Littelfuse.com/Sealed-ZCASE-FH

PART NUMBERS BULK	VOLTS	AMPS	DESCRIPTION
FHZS200	32V	400A	Sealed 6-Way ZCASE® Fuse Holder



Multiple Position Fuse Blocks

Additional information: Littelfuse.com/FuseHolders

ATO® • with 1/4" Quick Connect Terminals

Use with ATO® fuses up to 15 amps. Available in 5 pole unit with removable clear protective cover. Available in side or bottom positioned 1/4" Q.C. terminal configurations. Unit with bottom Q.C. terminals includes detachable side mounting brackets.

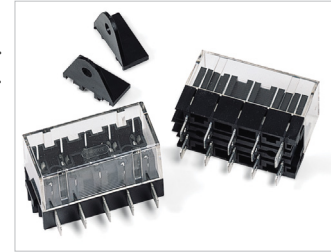

PART NUMBERS BULK 10 PIECE	PART NUMBERS CARDED	PART NUMBERS CATALOG NUMBER	DETAILS	AMPS	COVER
03500417TXN	03500417XP	350417BP	1/4" Q.C. side position	2-20A	•
03500418TXN	03500418XP	350418BP	1/4" Q.C. bottom position (includes mounting brackets)	25-30A	•

* Please inquire about additional bulk quantities

Omni-Blok® • with 1/4" Quick Connect Terminals

For 1/4" x 1-1/4" glass fuses. Available in one through twelve pole units. Units may be easily broken apart as needed to obtain the desired number of poles. Rated at 20A, 300 V.



PART NUMBERS BULK	PART NUMBERS CARDED	POLES	VOLTS	AMPS
03540801ZXGY	-	1	300 V	20A
03540802ZXGY	00MN0002XP	2	300 V	20A
03540804ZXGY	00MN0004XP	4	300 V	20A

Common Hot Feed Glass Fuse Block

Fiber base with 11/64" (4.4mm) diameter mounting holes. Solid brass busbar, phosphor-bronze fuse clips. Brass terminals and screws.



PART NUMBERS BULK	PART NUMBERS CARDED	PART NUMBERS RETAIL	MAX FUSE RATING PER CIRCUIT	FUSE POSITION	DIMENSIONS	BUSBAR
M-414-01	-	M-414-01-BP	20A	4	2.75"L x 2.24"W x .625"H	•
M-415-01	-	-	20A	5	3.50"L x 2.24"W x .625"H	•
M-641-01	M-641-01-BX	M-641-01-BP	20A	6	4.25"L x 2.24"W x .625"H	•
M-643-01	M-643-01-BX	M-643-01-BP	20A	8	5.75"L x 2.24"W x .625"H	•

M-674 • Combination Glass Fuse Block and Terminal Block

Combination Fuse Block & Terminal Block For SFE 20A or 3AG (AGC) fuses. Common hot feed to four independently-fused circuits, and common ground strip for four circuits. Solid brass busbars, terminals and terminal screws. Nickel-plated phosphor-bronze fuse clips. Two eyelet holes for mounting with 3/16" (4.8mm) screws, 2.25" (57.2mm) on centers.



PART NUMBERS BULK	PART NUMBERS BOXED	PART NUMBERS RETAIL	MAX FUSE RATING PER CIRCUIT	FUSE POSITION	DIMENSIONS	BUSBAR
-	M-674-BX	M-674-BP	20A	4	3.50"L x 2.75"W x .781"H	•

Laminated Base Fuse Block with Screw Terminals

For 1/4" x 1-1/4" glass fuses. Available in one through twelve pole units. Rated at 20A, 300 V.

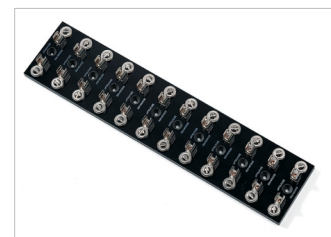

PART NUMBERS BULK	POLES	VOLTS	AMPS	PART NUMBERS BULK	POLES	VOLTS	AMPS
03560001Z	1	300V	20A	03560009Z	9	300V	20A
03560002Z	2	300V	20A	03560010Z	10	300V	20A
03560004Z	4	300V	20A	03560011Z	11	300V	20A
03560006Z	6	300V	20A	03560012Z	12	300V	20A

Terminal Blocks

M-42X • Individual Feed Screw Terminal Blocks

Moisture-resistant molded Bakelite insulator base with barrier strips. Nickel-plated brass terminal links and 8-32 binding head screws.

Additional information: Littelfuse.com/TerminalBlocks

PART NUMBERS BULK	PART NUMBERS BOXED	PART NUMBERS RETAIL	NUMBER OF POSITIONS	TERMINALS MATERIAL	TERMINALS SIZE	DIMENSIONS	MOUNTING HOLE DIMENSION
M-426	M-426-BX	M-426-BP	4	Nickel-Plated Brass	8-32	3.22"L x 1.31"W x .67"H	2.81" (71.4mm) on centers
M-427	M-427-BX	M-427-BP	6	Nickel-Plated Brass	8-32	4.33"L x 1.31"W x .67"H	3.93" (99.9mm) on centers
M-428	M-428-BX	M-428-BP	8	Nickel-Plated Brass	8-32	5.46"L x 1.31"W x .67"H	5.06" (128.5mm) on centers
M-429	M-429-BX	M-429-BP	10	Nickel-Plated Brass	8-32	6.59"L x 1.31"W x .67"H	6.19" (157.2mm) on centers
M-456	M-456-BX	-	14	Nickel-Plated Brass	8-32	8.84"L x 1.31"W x .67"H	8.44" (214.4mm) on centers

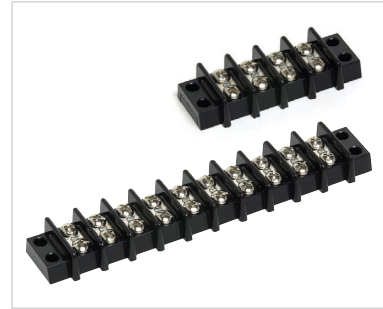

4721 • Individual Feed Stud Terminal Blocks

Moisture-repellent phenolic insulator base with brass stud terminals. Hexnuts, flat washers and lockwashers included. Two mounting holes accept 3/16" (4.8mm) screws (not included).

Additional information: Littelfuse.com/TerminalBlocks

PART NUMBERS BULK	PART NUMBERS BOXED	NUMBER OF POSITIONS	TERMINALS MATERIAL	TERMINALS SIZE	DIMENSIONS	MOUNTING HOLE DIMENSION
4721-P2	4721-P2-BX	2	Brass	10-32	2.68"L x .5/8"W x 27/32"H	1.87" (47.5mm) on centers
4721-P3	4721-P3-BX	3	Brass	10-32	3.25"L x .5/8"W x 27/32"H	2.50" (63.5mm) on centers
4721-P4	4721-P4-BX	4	Brass	10-32	3.87"L x .5/8"W x 27/32"H	3.12" (79.2mm) on centers
4721-P5	4721-P5-BX	5	Brass	10-32	4.5"L x .5/8"W x 27/32"H	3.75" (95.3mm) on centers
4721-P6	4721-P6-BX	6	Brass	10-32	5.12"L x .5/8"W x 27/32"H	4.38" (111.3mm) on centers
4721-P8	4721-P8-BX	8	Brass	10-32	6.37"L x .5/8"W x 27/32"H	5.62" (142.7mm) on centers
4721-P10	4721-P10-BX	10	Brass	10-32	7.62"L x .5/8"W x 27/32"H	6.87" (174.5mm) on centers
4721-P12	4721-P12-BX	12	Brass	10-32	8.87"L x .5/8"W x 27/32"H	8.12" (206.2mm) on centers
4721-P14	4721-P14-BX	14	Brass	10-32	10.12"L x .5/8"W x 27/32"H	9.37" (238.0mm) on centers



4758 & 4755 • Individual Feed Stud Terminal Blocks

Moisture-repellent molded insulator base with barrier strips. Two mounting holes accept 1/4" (6.3mm) screws. Hardware sold separately.

Additional information: Littelfuse.com/TerminalBlocks

PART NUMBERS BULK	PART NUMBERS BOXED	NUMBER OF POSITIONS	TERMINALS MATERIAL	TERMINALS SIZE	DIMENSIONS	MOUNTING HOLE DIMENSION
4758	4758-BX	4	Steel	10-24	4.5"L x .5/8"W x 27/32"H	3.75" (95.3mm) on centers
4755	4755-BX	5	Steel	10-24	5.25"L x .5/8"W x 27/32"H	4.5" (114.3mm) on centers



Terminal Blocks

M-449 & M-448 • Common Busbar Terminal Blocks

Moisture-resistant molded thermoplastic insulator base with solid brass busbar that safely carries up to 50A. Two 1/4-20 brass studs with hexnuts. 8-32 round head screws for attachment of wires. Two mounting holes accept No. 10 countersink flathead screws that are 5.19" (131.5mm) on center for 10-gang version, and 8.31" (211.07mm) on center for 20-gang versions.

Additional information: Littelfuse.com/TerminalBlocks

PART NUMBERS BULK	PART NUMBERS BOXED	PART NUMBERS RETAIL	NUMBER OF POSITIONS	TERMINAL MATERIAL	TERMINAL SIZE	DIMENSIONS	BUSBAR
M-449	M-449-BX	M-449-BP	10	Brass	8-32	5.75"L x 1.25"W x 1.031"H	•
M-448	M-448-BX	-	20	Brass	8-32	5.75"L x 1.25"W x 1.031"H	•
M-448-02	-	-	20	Tin-Plated Brass	8-32	8.875"L x 1.25"W x 1.031"H	•



46206-04 • Common Busbar Terminal Blocks

Moisture-repellent thermoset plastic insulator base with 3/16" (4.76mm) diameter mounting holes. Eyelets are 3.125" (79.4mm) on centers.

Additional information: Littelfuse.com/TerminalBlocks

PART NUMBERS BULK	PART NUMBERS BOXED	NUMBER OF POSITIONS	TERMINAL MATERIAL	TERMINAL SIZE	DIMENSIONS	BUSBAR
46206-04	46206-04-BX	4	Brass	10-32	3 7/8"L x 5/8"W x 27/32"H	•



86099 • Brass Busbars

Solid Brass busbar meant for mounting circuit protection including fuses and circuit breakers. Busbars tested to 70A with temperature rise no greater than 55°C.

PART NUMBERS BULK	PART NUMBERS BOXED	NUMBER OF POSITIONS	TERMINAL MATERIAL	DIMENSIONS	MOUNTING HOLE DIMENSIONS
-	86099-2-BX	2	Brass	1.53" long (38.9mm)	.910" (23.1mm) on centers, 0.21" (5.3mm) diameter
86099-3	86099-3-BX	3	Brass	2.43" long (61.7mm)	
86099-4	86099-4-BX	4	Brass	3.34" long (84.8mm)	
86099-5	86099-5-BX	5	Brass	4.24" long (107.7mm)	



86126 • Copper Busbars

Solid copper busbars meant for mounting circuit protection including fuses and circuit breakers.

PART NUMBERS BULK	PART NUMBERS BOXED	NUMBER OF POSITIONS	TERMINAL MATERIAL	DIMENSIONS	MOUNTING HOLE DIMENSIONS
86126-2	86126-2-BX	2	Copper	1.41" x .560" (35.8 x 14.2mm)	.910" (23.1mm) on centers
86126-4	86126-4-BX	4	Copper	3.23" x .560" (82.1 x 14.2mm)	2.73" (69.34mm) on centers
86126-6	86126-6-BX	6	Copper	5.05" x .560" (128.3 x 14.2mm)	4.55" (115.57mm) on centers
86126-8	86126-8-BX	8	Copper	6.87" x .560" (174.5 x 14.2mm)	6.37" (161.79mm) on centers
86126-12	86126-12-BX	12	Copper	10.51" x .560" (267.0 x 14.2mm)	10.01" (254.25mm) on centers



Why Should You Use a Fuse Holder?

Every fuse requires a fuse holder for installation. That's because fuse holders perform two essential functions.

The first is to mount the fuse or fuses in a convenient or easily accessible location, whether it is for the sake of integration in assembly or for applications that require frequent serviceability.

The second job of a fuse holder is to shield the critical circuit protection elements in an application against environmental conditions, whether it's simply safeguarding against debris interfering with the connections or providing full waterproof and dust-tight protection.

Application Considerations

Fuse holders are designed to work with specific fuses. However, your application requirements will dictate the type of fuse and fuse holder you need. When selecting a fuse and fuse holder, consider your application's electrical load requirements, number of circuits, and mounting location.

Do you need circuit protection for a low-amperage or high-amperage application? Are you trying to protect multiple circuits in a tight space? Will you need to mount the fuse holder in an exposed location?

Littelfuse offers a large portfolio of in-line and bolt-down fuse holders, and fuse blocks for high-current and low-current applications as well as options that are waterproof or splashproof or come with an ignition protection rating.



In-Line Fuse Holders

In-line fuse holders offer a flexible, quick solution for placing fuses in cramped spaces or for adding overflow circuits or accessory circuits for low-current applications, such as electronics, panel displays, blower motors, air conditioners, and lighting.

In our portfolio, you'll find in-line fuse holders for ATO®, MINI®, MAXI®, JCASE®, MIDI®, and glass fuses. We offer in-line fuse holders with various wire lead sizes, colors, and lengths to accommodate different industry guidelines and applications. Plus, we have options with and without covers and with and without waterproof ratings.



Bolt-Down Fuse Holders & Fuse Blocks

For high-current applications, such as battery and alternator connections and starter fusing, the electrical requirements dictate the use of larger fuses like MEGA®, MIDI®, and ZCASE®. Because of their larger size and placement requirements, these fuses typically need a bolt-down fuse holder or multi-fuse block to house and protect them from harsh conditions. For these applications, we offer battery-mount, stud-mount, bolt-down fuse holders with and without waterproof ratings and ignition protection ratings.

Littelfuse also offers fuse blocks and boxes for both high-amperage fuses, such as MEGA® and MIDI®, and low-amperage fuses, such as ATO® and MINI®, that are designed for efficient multi-fuse installation and power distribution.



ZCASE® FHZ bolt-down fuse holders

Circuit Protection & Electrical Ratings

While the fuse is what we typically think of as providing the circuit protection because it is the weak link that breaks when there is a type of fault in the circuit, the fuse holder is an essential part of circuit protection that helps prevent injuries and damage to vehicles.

Though fuse holders are designed to work with specific fuse types, it is important to look for the electrical ratings, such as maximum voltage and maximum current, of the fuse holder to ensure the fuse holder can support the intended fuse.

Power Distribution Modules



Power Distribution Modules (PDMs) are devices that accept electrical power from one or more wires (inputs) and then distribute it to multiple cables (outputs). The PDMs also accept power protection and control devices from one or more fuse, circuit breaker, relay, diode, or even solid state and electronic circuitry and distribute to multiple outputs.

Blade or Bolt-Down Fuse?

DC (automotive) fuses are offered in three basic forms: Blade, Cartridge and Bolt Down.

Blade & Cartridge fuses can be hand inserted into a fuse holder. These fuses provide protection for several amperage ratings up to 80A. They are well suited to protect smaller to medium diameter wires that are usually some distance from the battery. Single blade power distribution units are often called 'In-Line' power distribution units as they are spliced into the wiring. Remember to place the fuse holder as close to the battery and as far away from the load as possible, so that it protects the wire from a short anywhere along its length. Any short between the power source and the fuse is not protected. Littelfuse blade fuses include: MICRO2®, MICRO3®, MINI®, LP MINI®, ATO®, MAXI®, MCASE+®, JCASE® and LP JCASE®.

Bolt Down fuses need to be secured to the fuse holder with a screw, nut or bolt. These fuses provide protection from 30A to 600A. They are well suited to protect medium to large diameter wires that are usually closer to the battery. Ring terminals are crimped onto cables that are connected to these holders and spliced into the wiring. Remember to place the fuse holder as close to the battery and as far away from the load as possible, so that it protects the wire from a short anywhere along its length. Any short between the power source and the fuse is not protected which is why you should have master fusing as close the battery as possible. Littelfuse bolt-down fuses include: MIDI®, MEGA®, CF8 and ZCASE®.

Also, there are still a wide variety of applications that use glass tube fuses. These are typically lower current values and are becoming less popular for most automotive applications due to their size, form factors, and lack of color coding.



Hard-Wired Boxes

HWB Series • Compact Sealed Hard-Wired Boxes • 2.8mm Style Fuses & Relays

The HWB series hard-wired boxes are sealed units that accept any 2.8mm style fuses, relays, circuit breakers or diodes depending on which HWB model is selected. The HWB series is the perfect fit for accessory circuits and overflow circuits from your main power distribution module.

The series features durable construction, IP67 & IP69K ratings, compact sizes, gasket sealed covers and multiple mounting types. See chart below for specific details. The HWB series eliminates the use of internal bussing allowing the user or design engineer to customize the circuitry utilizing direct wire-to-component connections. TPAs (terminal position assurance locks) give secondary locking protection of the wire leads, which aid in prevention of leads from being pulled out and snap onto the back after wires are installed.

- Accepts a combination of 2.8mm components – MINI® fuses, relays, circuit breakers or diodes. (sold separately)
- Cover tethers available to prevent loss of component during service.
- HWB60 series are modular and can be dovetailed together to expand circuit protection capacity. They can also be interlocked to other PDMs and fuse holders (FLEC Flexible Electrical Control Center and MEGA/MIDI Flex fuse holder)
- HWB60 and HWB18 series uses Delphi Metri-Pack 280 terminals, cable seals and cavity plugs.
- Download datasheet for specific details.
- HWB12 and HWB6 series are available with black or clear covers for easy component status identification.
- HWB12 and HWB6 series use TYCO MCP terminals, cable seals and cavity plugs. See datasheet for specific details.

Additional information: Littelfuse.com/HWB



HWB60-AL



HWB60

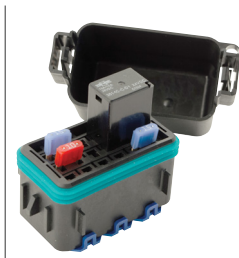

HWB18

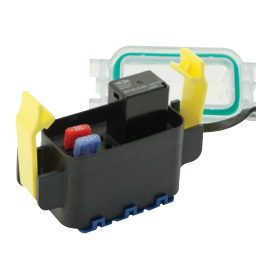

HWB12

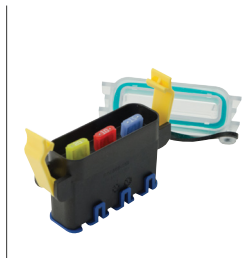

HWB6

SERIES	PART NUMBERS BULK	MAX CONTINUOUS CURRENT	MAX FUSE RATING PER CIRCUIT	NUMBER OF CAVITIES	MOUNTING TORQUE	INGRESS PROTECTION	DIMENSIONS	TERMINALS		KIT CONTENTS				
								DELPHI METRI-PACK	TYCO MCP	COVER	ASSURELATCH	GASKET	TPAS	BRACKET
HWB60-AL	PDM71001ZXM	250A	30A	60	4-6 Nm	IP67 & IP69K	113x52x82mm	•	-	Black	•	•	•	-
HWB60-AL	PDM71003ZXM	250A	30A	60	4-6 Nm	IP67 & IP69K	113x52x82mm	•	-	Black	•	•	•	-
HWB60	PDM21001LXM	250A	30A	60	4-6 Nm	IP67 & IP69K	113x52x82mm	•	-	Black	-	•	•	-
HWB18	PDM31001ZXM	200A	30A	18	5.5-6.5 Nm	IP67 & IP69K	60x38x74mm	•	-	Black	-	•	•	•
HWB18	PDM31002ZXM	200A	30A	18	5.5-6.5 Nm	IP67 & IP69K	60x38x74mm	•	-	Black	-	•	•	-
HWB12	PDM33001ZXM	130A	30A	12	5.5-6.5 Nm	IP67 & IP69K	83x70x44mm	-	•	Clear	•	•	•	-
HWB12	PDM33003ZXM	130A	30A	12	5.5-6.5 Nm	IP67 & IP69K	83x70x44mm	-	•	Clear	•	•	•	•
HWB12	PDM33004ZXM	130A	30A	12	5.5-6.5 Nm	IP67 & IP69K	83x70x44mm	-	-	Black	-	-	-	•
HWB6	PDM32001ZXM	68A	30A	6	5.5-6.5 Nm	IP67 & IP69K	71x64x36mm	-	•	Clear	•	•	•	-
HWB6	PDM32003ZXM	68A	30A	6	5.5-6.5 Nm	IP67 & IP69K	71x64x36mm	-	•	Clear	•	•	•	•
HWB6	PDM32004ZXM	68A	30A	6	5.5-6.5 Nm	IP67 & IP69K	71x64x36mm	-	-	Black	-	-	-	•

DC Power Distribution Brochure



DOWNLOAD

Power Distribution Modules

HWA20 Series • ATO® Fuse Hard-Wired Box

Compact hard-wired fuse holder holds up to 10 ATO blade fuses, with a combined amperage up to 210A. Perfect for accessory circuits, overflow circuits from main power distribution module, or as a main module on smaller vehicles.

- Without internal bussing: enables the user to customize the circuitry.
- Dovetail slots on the sides of the box interlock with other units.
- Easy to connect wires plug into the back of the unit using industry-standard Tyco sealed power terminals.



Additional information: Littelfuse.com/HWA20

SERIES	PART NUMBERS BULK	MAX CONTINUOUS CURRENT	MAX FUSE RATING PER CIRCUIT	FUSE POSITIONS	MOUNTING TORQUE	INGRESS PROTECTION	DIMENSIONS	CONTENTS COVER	CONTENTS GASKET	CONTENTS TPAs
HWA20	PDM61001ZXM	210A	40A	10	4-6 Nm	IP67	161x40x52mm	•	•	•

MTR Series • (2+2) MINI® & JCASE® Fuse Hard-Wired Box

Sealed low to medium current fuse holder houses two JCASE cartridge fuses and two MINI bladed fuses. Holder is gasket-sealed to protect fuses from moisture and contamination. Fuses are internally bussed to a single main power stud – one input powers four fuse circuits. Utilizes the MINI fuse for fast-acting 2-30A circuit protection and the JCASE cartridge style fuse with increased time delay for 20-60A medium current circuits. Output circuits are designed for use with Delphi terminals.



Additional information: Littelfuse.com/MTR

SERIES	PART NUMBERS BULK	MAX CONTINUOUS CURRENT	MAX FUSE RATING PER CIRCUIT	FUSE POSITIONS	MOUNTING TORQUE	INGRESS PROTECTION	DIMENSIONS	CONTENTS COVER	CONTENTS GASKET	CONTENTS TPAs
MTR	BPDMA104HXF1	100A	2-60A	4	6-8 Nm	IP67	86x34x77mm	•	•	•

LTX Series • 4 position MEGA® & 2 position MINI® Fuse Box

The LTX Power Distribution Module is a high current sealed primary fuse box that can be placed in the battery box, or near the battery box to fuse major feeder cables. Featuring bussed input to all 6 MEGA and 2 MIDI fuses. All bolt down connections are made inside of the seals which enhances the environmental protection of the box.



Additional information: Littelfuse.com/LTX

SERIES	PART NUMBERS BULK	VOLTAGE	MAX FUSE RATING PER CIRCUIT	FUSE POSITIONS	MOUNTING TORQUE	INGRESS PROTECTION	DIMENSIONS	CONTENTS COVER	CONTENTS GASKET	CONTENTS BUSBAR
LTX	07981002ZXS	6-32V DC	240A	6	10-12 Nm	IP66	231x312x60mm	•	•	•

SL Series • 350A • Power Distribution Module

The SL Series provides main battery shutdown from a remote location, optional manual control knob switches high-amp circuits, three switched 30A to 200A MIDI® fuse location, four unswitched 24-hour 1A-20A ATO® fuse locations and eliminates significant factory or field interconnections.

- Littelfuse Remote Control Switch: 880092

Additional information: Littelfuse.com/SL



PART NUMBERS BULK	MAX FUSE RATING PER CIRCUIT	MAX FUSE RATING PER CIRCUIT MIDI	MAX FUSE RATING PER CIRCUIT ATO	FUSE POSITIONS	TERMINAL STUD TORQUE	INGRESS PROTECTION	DIMENSIONS	CONTENTS COVER	DESCRIPTION
880075	350A	170A	30A	7	20 Nm	IP59k	152x102x45mm	•	16 V Max Power Distribution Module with Remote Switching
880076	350A	170A	30A	7	20 Nm	IP59k	152x102x45mm	•	16 V Max Power Distribution Module with Remote Switching and Manual Control

Power Distribution Modules

MDB Series • MIDI® Fuse Distribution Box

Internally bussed, water-proof and dust-proof fuse holder developed for high current loads, and harsh conditions. The unit is well-suited for near-the-battery applications and can be mounted in exposed locations to fit your design. Available for 2 or 3 MIDI fuses and includes the cover seal and M5 thread bolts for a fuse installation. Kits include seals, plugs and caps. Fuses are sold separately.

- AssureLatch™ Technology keeps the cover securely in place while allowing for fast service.
- Included tether connects cover to base preventing misplacement.
- The module is internally bussed allowing for high current power distribution.
- Sealed to IP67 and IP69K for maximum flexibility in mounting location.



Additional information: Littelfuse.com/MDB

PART NUMBERS BULK	PART NUMBERS BOXED	POLES	VOLTAGE	MAX CONTINUOUS CURRENT	MAX FUSE RATING PER CIRCUIT	MOUNTING TORQUE	INGRESS PROTECTION	DIMENSIONS	CONTENTS
04980932ZXT	-	2	6-58 VDC	200A	200A	6-8 Nm	IP67 & IP69K	131x68x38mm	2-pole box with busbar and nuts
04980933ZXT	-	3	6-58 VDC	200A	200A	6-8 Nm	IP67 & IP69K	131x68x38mm	3-pole fuse box with busbar & nuts
-	04980932.X	2	6-58 VDC	200A	200A	6-8 Nm	IP67 & IP69K	131x68x38mm	Input: 1x 25 mm² cap 1x 25 mm² seal
-	04980933.X	3	6-58 VDC	200A	200A	6-8 Nm	IP67 & IP69K	131x68x38mm	

LX Series • 200A & 600A • ATO® & MIDI® Fuse PDM

Protect high and low-amp circuits while providing a collection point for ground returns, and eliminate battery box clutter and damage to battery terminals when adding circuits. Combines an ignition protected fuse block with screw termination. Holds four 30A-200A MIDI fuses and six 1A-30A ATO fuse locations. Negative bus provides common location for ground returns.

- The 880094 provides one fused input feeding the unit and other fuses while, the 880089 has an unfused input feeding the fuse circuits.

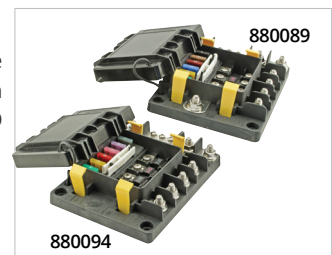

Additional information: Littelfuse.com/LX

SERIES	PART NUMBERS BULK	VOLTAGE	MAX FUSE RATING PER CIRCUIT MIDI	MAX FUSE RATING PER CIRCUIT ATO	FUSE POSITIONS	MOUNTING TORQUE	INGRESS PROTECTION	DIMENSIONS	CONTENTS COVER	CONTENTS GASKET	CONTENTS PULLER
LX	880089	600A	170A	30A	10	20 Nm	IP59k	165x127x51mm	•	•	•
	880094	200A	170A	30A	10	20 Nm	IP59k				

XT Series • 350A • ATO® & MIDI® Fuse PDM

The XT combines an ATO fuse block that has integrated sealed plug outputs (FCI APEX 2.8mm female 4-way connector p/n 54200409) and a MIDI fuse block that consolidates up to seven circuits from 1–200A. Three 30–200A MIDI fuse locations are ideal for high-amp circuits and four 1–40A ATO fuse locations for low-amp circuits. Tin-plated copper busbar and stainless steel studs and hardware provides superior corrosion resistance.



Additional information: Littelfuse.com/XT

SERIES	PART NUMBERS BULK	MAX CONTINUOUS CURRENT	MAX FUSE RATING PER CIRCUIT MIDI	MAX FUSE RATING PER CIRCUIT ATO	FUSE POSITIONS	MOUNTING TORQUE	INGRESS PROTECTION	DIMENSIONS	CONTENTS COVER	CONTENTS GASKET
XT	880073	350A	170A	30A	7	20 Nm	IP59k	152x102x45mm	•	•

Power Distribution Modules

FLEC® Series • Configurable Flexible Electrical Center

The Flexible Electrical Center (FLEC) is a power distribution module for the commercial vehicle market. It accommodates circuit protection components in a compact, sealed footprint. The PCB accepts active and passive devices. Part number below is a standard market version but FLEC is configurable to your custom electrical schematic and can be programmed to create a simple “plug-and-play” system.

- High component density maximizes available space and limits the number of additional units required.
- The versatile nature of the FLEC unit means it can accept a large number of component types.
- Rugged and sealed, the unit boasts an IP67 rating which allows it to be mounted in locations susceptible to moisture and dirt without any adverse effects.



Additional information: Littelfuse.com/FLEC

SERIES	PART NUMBERS	DESCRIPTION	VOLTS	MAX LOAD	MAX FUSE RATING	FUSE CAPACITY	RELAY CAPACITY	INGRESS PROTECTION	OUTPUT CONNECTORS
FLEC	FLEC3000Z-0	With MINI Fuses & Relays	12-24V DC	300A	30A	28	18	IP67	Delphi GT
	FLEC3000Z-0U	No Fuses or Relays	12-24V DC	300A	30A	28	18	IP67	Delphi GT

MiniFLEC™ Series • 150A • Connectorized Power Distribution Module

The standard MiniFlec is a compact, front access, internally bussed, connectorized, sealed power distribution module, suitable for mounting in rugged commercial vehicle applications. An internally mounted Printed Circuit Board (PCB) allows bussed connections to a large number of devices.

- Designed for panel mounting (rear fed connectors). Base compression limiters prevent over-torquing when unit is mounted
- Tethered cover securely latches to base, with positive AssureLatch yellow latches



Additional information: Littelfuse.com/MINIFLEC

SERIES	PART NUMBERS BULK	MAX LOAD	FUSE RATING RANGE	INPUT STUD	MOUNTING TORQUE	INGRESS PROTECTION	DIMENSIONS	RELAY CAPACITY
MINIFLEC	LFMX0007Z-01	150A	MINI® Fuse: 2-30A MCASE+® Fuse: 15-60A	M8	12-15Nm	IEC 529 IP67/69K	157mm x 96mm x 126mm	3 Form C 280 Series Micro Relays, 3 Form A Ultra Micro Relays, 1 ISO Micro Relay

EPC Series • 200A • Connectorized Power Distribution Module

The standard EPC is an internally bussed, connectorized, sealed power distribution module, suitable for mounting in rugged commercial vehicle applications. The EPC is a product that has dense concentration of high power circuits and accepts plug devices like automotive fuses, diodes and relays to protect and control complex electrical systems. An internally mounted Printed Circuit Board (PCB) allows bussed connections to a large number of devices.



Additional information: Littelfuse.com/EPC

SERIES	PART NUMBERS BULK	MAX LOAD	FUSE RATING RANGE	MOUNTING TORQUE	INGRESS PROTECTION	DIMENSIONS	RELAY CAPACITY
EPC	LFLEX0006Z-01	200A	5 to 30A	6-8Nm	IP67 / IP69K	179mm x 155mm x 69 mm	Tailor to application - Up to 3 Form C 280 and 6 Form A 280 Relays

Power Distribution Modules

HV PDU • High Voltage Power Distribution Unit

Whether you're designing an electric vehicle (EV) for the road or manufacturing an off-highway electric vehicle, you need solutions to reliably deliver power, protect vehicle components, and keep end-users safe while reducing your system costs.

That's why Littelfuse offers customizable high-voltage power distribution units (HV PDUs), which can be tailored to optimize power distribution in specific EV systems. Our HV PDUs, which combine our high-voltage DC contactors and fuses with current sensing, thermal protection, on-board charging, and other capabilities, are flexible and ready to handle the challenges of powering next-generation vehicles.

Our engineers will work with you to customize and develop an HV PDU configuration to meet the requirements of your application.

Additional information: [Littelfuse.com/HV-PDU](https://www.littelfuse.com/HV-PDU)



DC Contactors

We offer a growing portfolio of high-voltage DC contactors developed specifically for EV and alternative energy applications. With magnetic arc blowouts, coil economizers, and polarized and non-polarized options, our HV DC contactors are safe, reliable, and efficient.



Bussing Systems

PCBAs and busbars in our customizable HV PDU optimize power distribution.

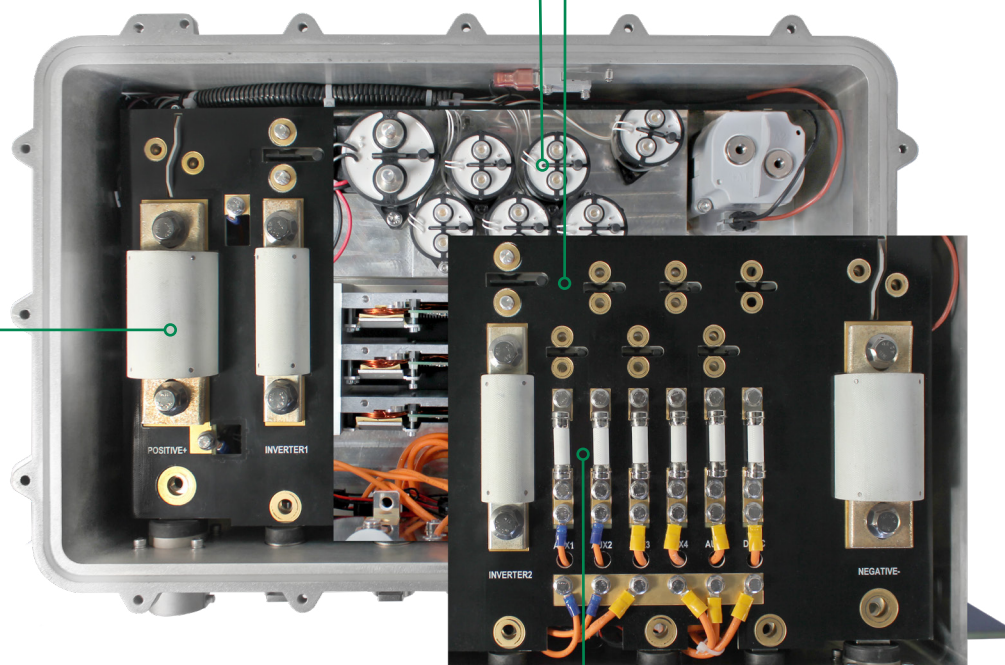

Fuses

To protect high-voltage, high-current on-board applications in electric and hybrid vehicles as well as off-board charging, we offer high-voltage fuses that have been built to meet the stringent requirements and standards of the EV industry.



Customizable

Built within an IP67/6K9K-rated centralized junction box, our HV PDUs provide customizable system integration of:

- DC/DC conversion
- On-board charging
- Pre-charge functions
- Current and voltage measurement
- Insulation monitoring
- HVIL and shielding

Current Sensing

In-house-designed DC current sensing capabilities can be built into our HV PDUs to help ensure the smart management of available battery power, increasing vehicle efficiency and promoting smooth operation.

Thermal Simulations and Testing Capabilities

Our global team of engineers designs innovative solutions and performs product testing to ensure you have the best solution that meets all requirements and regulations. We have capabilities in thermal, static structural and vibration and magnetostatic simulation.

Battery Management



Isolators or Combiners?

Battery Isolators are passive (not intelligent) devices. They are a basic technology that prevents current from draining from one battery into the other. As current passes through the internal diodes there's a loss of efficiency, that equates to a voltage loss of 10-15%. Another problem arises when battery isolators are used with the more recent 'smart alternators'. Such alternators incorporate sensors which 'read' the state of the battery, but the isolator's diodes interfere with the alternator's sensors. It is therefore important to use a battery combiner in such application.

Battery combiners provide the same function as isolators, but without the substantial voltage loss, and they work in harmony with smart alternators. They also may have additional useful features, such as boost; they are smaller and lighter; and since they are installed between the battery banks, there is no need to cut the original OEM heavy cable from alternator to battery.

No More Dead Batteries!

If you leave a fully charged battery connected in an inactive vehicle, it could be dead in as little as two months. Vehicles have electronics that continue to draw small quiescent currents to maintain their memory, even when the vehicle is off. Over an extended period of time this small current can drain the battery. Complete discharge of the battery can cause permanent damage and prevent proper battery recharging.

If your vehicle requires short or long term storage and has a lot of electronics (computer, TV, stereo, etc) a Low Voltage Disconnect can be installed to automatically disconnect these components when battery voltage falls below a critical threshold and automatically reconnects when the battery is recharged. This lengthens the storage life of your battery.

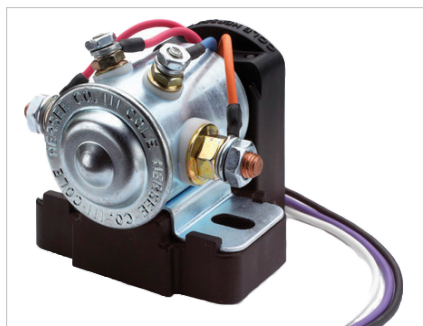

Battery Isolators

85-200A Smart Battery Isolators

Battery Combiners are hybrid electronic/electromechanical relays that prevent loads on the auxiliary battery from draining the starting battery. This type is more flexible than Diode Battery Isolators: works with all types of alternator; it is smaller and lighter; no efficiency loss due to diodes; allows bi-directional charging from the alternator or from shore power; reduces the load on the charging system by not connecting the auxiliary battery until the primary battery is charged to 13.2V.

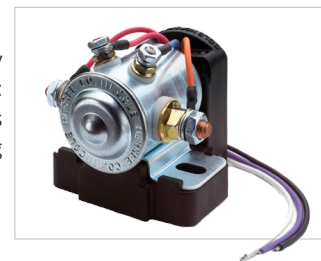

- Works with most types of alternators
- Smaller and lighter than traditional isolators
- No efficiency losses due to diodes
- Allows bi-directional charging from the alternator or from shore power
- Reduces the load on the charging system by not connecting the auxiliary battery until the primary battery is charged to 13.2V extending the life of expensive charging components.

Additional information: Littelfuse.com/BatteryIsolators

PART NUMBERS BULK	PART NUMBERS BOXED	VOLTS	AMPS	TERMINAL STUDS	INGRESS PROTECTION	CONNECT VOLTAGE	DISCONNECT VOLTAGE	QUIESCENT CURRENT	TERMINAL STUD TORQUE
48525	48525-BX	9-16V DC	85A	5/16-24"	IP66	13.2V typical after 2 minutes	12.7 V after 1 minute	5mA typical, 8mA max	35 in-lbs (3.95Nm)
48530	48530-BX	9-16V DC	200A	5/16-24"	IP66	13.2V typical after 2 minutes	12.7 V after 1 minute	5mA typical, 8mA max	35 in-lbs (3.95Nm)

3 & 4 Stud Diode Battery Isolators

For vehicles with two batteries, these devices electrically isolate the batteries to prevent the battery with the higher charge from draining into that with the lower charge. In addition, both batteries can be charged simultaneously from one source.

The solid-state components are embedded to give excellent protection from adverse conditions, such as contamination and vibration. The integral heat sink provides efficient heat dissipation. The amp rating of each item is the maximum alternator rating.

Some alternators on vehicles have an integral electronic voltage regulator that requires the use of the 4-stud battery isolator. The small 4th stud is for connection to a circuit switched by the ignition switch. These alternators were first introduced by Delco and are therefore sometimes called 'Delcotron-type alternators'. Battery Isolators have a 'per leg' rating which indicates the maximum current that it can deliver to each battery. All Battery Isolators have a per leg rating equal to half the alternator rating. Thus a 48122 battery isolator with an alternator rating of 140A has a per leg rating of 70A per leg.

Additional information: Littelfuse.com/BatteryIsolators

Schottky Diode - Comply to KKK-A-1822B spec for Ambulances



PART NUMBERS BULK	PART NUMBERS BOXED	VOLTS	AMPS	TERMINAL NUMBER OF STUDS	TERMINAL THREADS	DIMENSIONS	ALTERNATOR TYPE
48051	48051-BX	12V DC Only	75A	2	2x 1/4"	3-1/2" x 4-15/16" x 3-11/32"	-
48161	48161-BX	12-36V DC	250A	3	3x 5/16"	8-1/2" x 4-3/16" x 3-13/32"	-
48122	48122-BX	12-36V DC	140A	4	3x 5/16" & 1 #10	6" x 4-3/16" x 3-11/32"	Delcotron-Type
48162	48162-BX	12-36V DC	200A	4	3x 5/16" & 1 #10	8-1/2" x 4-3/16" x 3-13/32"	Delcotron-Type
48070	48070-BX	12-36V DC	70A	3	3x 1/4"	5" x 3-1/4" x 2-3/16"	Without Integral Electronic Voltage Regulator
48090	48090-BX	12-36V DC	90A	3	3x 1/4"	6-1/2" x 3-1/4" x 2-13/16"	Without Integral Electronic Voltage Regulator
48120	48120-BX	12-36V DC	140A	3	3x 5/16"	6" x 4-3/16" x 3-11/32"	Without Integral Electronic Voltage Regulator
48160	48160-BX	12-36V DC	200A	3	3x 5/16"	8-1/2" x 4-3/16" x 3-13/32"	Without Integral Electronic Voltage Regulator

3- Stud Wiring Diagram

48070, 48080, 48090, 48160 and 48161

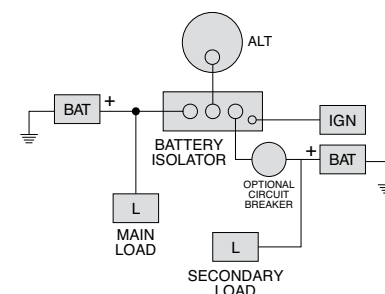

Battery Combiners & FlexMod™ Devices

FlexMod™ Electronic Devices

The FlexMod Series of products are compact, robust electronic modules with two inputs (one analog and one digital) and two solid state outputs (one 10A, one 200 mA) that can be programmed to do almost any job. Littelfuse offers standard units listed below to meet the most common application needs.



- Auto-ranging to automatically senses the voltage of the system (12 or 24V) and selects the pre-sets appropriate to that voltage.
- Ultra low 1mA standby current means minimal battery drain – especially valuable when vehicle is in storage or not in use.
- Factory programmable unit is versatile with a broad range of presets available for special applications.
- Rated for more than 1,000,000 on-off cycles – unit operates for the lifetime of the vehicle. Solid state technology gives long life and low maintenance.
- Provides overvoltage and overcurrent protection to every direct load in that circuit- for extra protection.
- Small lightweight sealed design – Uses less space; mounts outside or inside. Saves money by eliminating other hardware, and provides better wire routing

Additional information: Littelfuse.com/FlexMod

PART NUMBERS BULK	PART NUMBERS BOXED	TYPE	HARNESS INCLUDED
-	48636-01-BX	Timer for Trailer Lighting	•
48610	48610-BX	Low Voltage Disconnect	-
-	48541-01-BX	Voltage Sensing Relay & Timer	•
48540	-	Smart Battery Isolator Controller	-
-	48540-01-BX	Smart Battery Isolator Controller	•

Low Voltage Disconnect - 48610: Preserves battery charge and protects battery banks by automatically disconnecting loads when battery voltage drops to a critical level.

Smart Battery Isolator Controller - 48540: Monitors two battery banks and controls - one relay or contactor to make sure starting power is protected by isolating the starting and auxiliary battery banks.

Low Voltage Disconnect Accessories

Accessories for 48513 and 48514 series low voltage disconnects.



58326-06

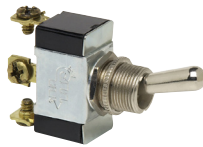

55088



12804

PART NUMBERS BULK	PART NUMBERS BOXED	DETAILS	NOTES
48710	-	FlexMod Unit	Programmable FlexMod LVD Unit • 10A • 9V DC
58326-06	-	Rocker Switch	SPDT • On-Off-Mom On • 5 Blade Terminals • Red LED
55088	55088-BX	Toggle Switch	SPDT • On-Off-Mom On • 3 Screw Terminals
12804	-	Harness	Deutsch DT06-4S connector • 0462-201-1641 terminal • W4S wedge and wiring
12805	-	FlexMod Harness	FlexMod 8-Pin Deutsch Harness Accessory

How A Smart Battery Isolator Works

Normal Operation Sequence

1 When the vehicle has been running, the alternator charges both battery banks through the Smart Isolator.

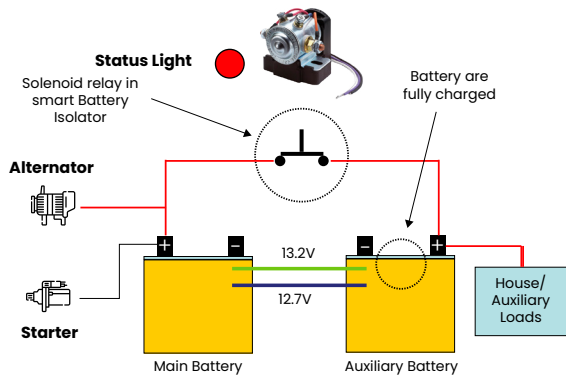

2 When the engine is turned off, the alternator no longer supplies a charge to the batteries, and the loads on the batteries begin to deplete them.

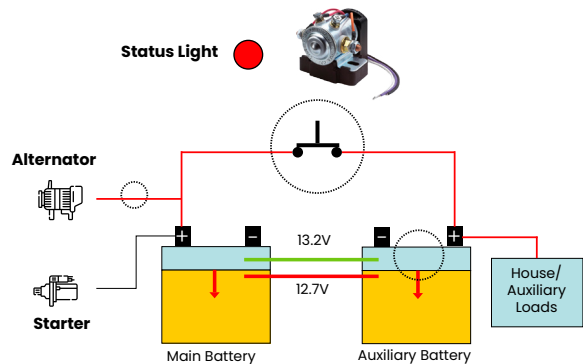

3 When batteries reach 12.7V, the Smart Battery Isolator senses it, opens the solenoid relay to separate the battery banks, and turns off the status light. This protects the starting battery while allowing the auxiliary battery to continue to power the auxiliary loads.

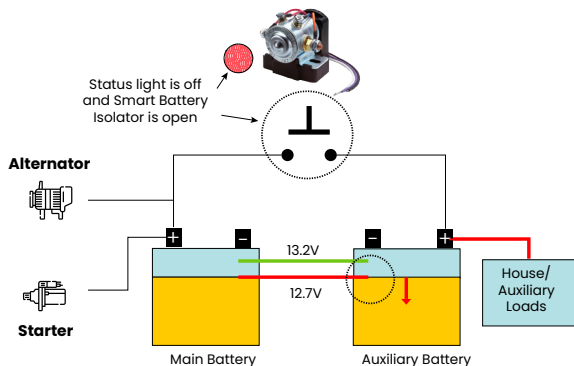

4 When the vehicle is restarted, the starting battery has enough power to crank the engine, but the auxiliary battery is significantly depleted. The Smart Battery Isolator is open and the battery banks are separated.

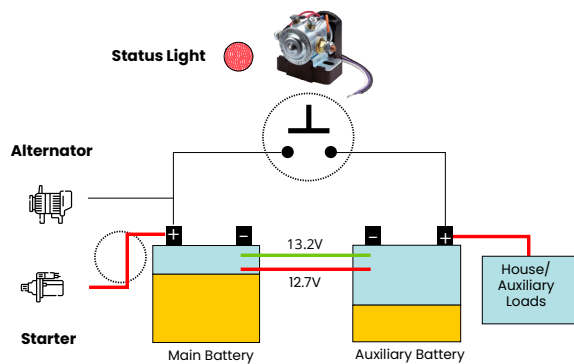

5 The engine is powering the alternator, and the starting battery has reached 13.2V. Only now does the Smart Battery Isolator reconnect, enabling the depleted auxiliary battery to be charged. By not reconnecting until the main battery is charged, the alternator is protected from excessive loads.

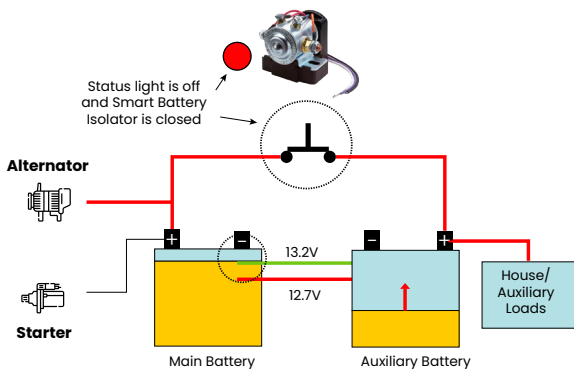

6 Now both batteries are charged again.

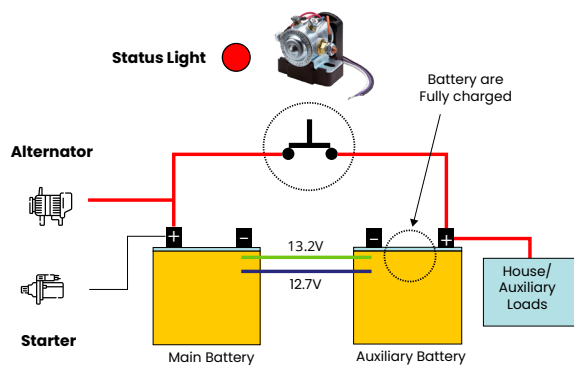

Relays and Solenoids

DC solenoids are relays used for remote switching of electrical currents from 20A to 600A. Littelfuse offers a variety of DC solenoids and relays, such as solid state relays, plug-in relays, compact relays among others.

Solenoids or Relays?

The terms solenoid and relay are interchangeable and refer to a type of remote switch. In the automotive context, solenoid refers to the metal can device. A relay refers to all other such devices including the small micro relays referenced later in this section. The word solenoid actually refers to the helical windings that create the magnetic force which pulls the plunger in the core. Littelfuse manufactures a very broad range of remote switches.

Intermittent or Continuous?

Relays are rated for Intermittent Duty or Continuous Duty. Intermittent duty relays are rated with maximum On times and minimum Off times, which is a workable situation in many applications. Exceed those specs and you run the risk of burning out the coil windings. You cannot use an Intermittent Duty relay for continuous service, but you can use a Continuous Duty relay for intermittent service – although you would be purchasing a relay that is in excess of your needs.

Bistable & Latching?

When it comes to solenoids or relays, both bi-stable and latching refer to the same function. A bi-stable state is one in which a moving contact is at rest in two configurations, either the On or Off position. This is achieved by a mechanical or magnetic latching mechanism which maintains contact in the ON or OFF position while device is not energized. A more well-known example of the mechanical style is the mechanism of a retractable ballpoint pen, where the user pushes to move the ballpoint out of the housing, and pushes again to retract the ballpoint. The point remains in either of two stable states until the user presses the actuator. In standard solenoids or relays, a control current has to be maintained in order to keep the plunger in the On position; in a bi-stable relay, control current is only applied when changing between the two states of Off and On. This provides many advantages – no current is used in the On or Off states, and bi-stable relays generate less heat.

Relays Brochure



↓ DOWNLOAD



Bi-Stable Latching Relays

HD Series • 300A General Purpose Bi-Stable Relays

- Very low current draw to maintain closed circuit
- Remotely-operated 300A disconnect for high-amperage circuits
- Small control wires: eliminates the cost and weight of routing large copper cables
- Bi-stable (latched) operation draws no current in On or Off: eliminates a continuous demand on batteries.
- LED output wire enables remote indication of relay status – Open or Closed.
- Silver alloy contacts assure the lowest voltage drop/resistance and extends cycling life of the device.
- Stainless steel hardware and tin-plated copper contacts maximize resistance in harsh environments.



Additional information: Littelfuse.com/HD-Relay

PART NUMBERS BULK	VOLTS	AMPS	INGRESS
880086	12V DC	300A	IP66/IP69k
880088	24V DC	300A	IP66/IP69k

HD Time Delay Series • 250A Bi-Stable Relay

The Heavy Duty Time Delay Bi-Stable Relay is able to disconnect the battery from the electrical system of vehicles in 12V and 24V, with voltage self-recognition.

- It includes immediate switch ON, controlled switch OFF with programmable delay time and service state managing (service switch OFF and switch ON).
- This Heavy Duty Time Delay Bi-Stable Relay has a non-volatile memory, low battery alert system and is thermal protected.



Additional information: Littelfuse.com/HDTimeDelay

PART NUMBERS BULK	VOLTS	AMPS	VOLTAGE RANGE	INGRESS	NOTES
08070900	12/24V DC	250A	8.5V to 32V @ 23°C	IP67	Light Line Current Rating: 1.3A continuous (6.5A protected)

SD Series • 300-600A Bi-Stable Relay

An all-vehicle battery disconnect, designed to support remote power switching applications. Great for high continuous current passage, large engine starting needs and high ambient temperatures.

- Small control wires: eliminates the cost/weight of routing large copper cables to an accessible switch.
- Dedicated 24-hour output, thermally protected, for tachograph or other keep-alive functions.
- Supports multiple Off switch control applications.
- Ignition protected to SAE J1171 and ISO 8846 for installation in battery box or with hazardous loads.
- Auxiliary relay contacts (normally open & normally closed) for Alternator Field Disconnect (AFD) or for additional vehicle system control



Additional information: Littelfuse.com/SDRelay

PART NUMBERS BULK	PART NUMBERS BOXED	VOLTS	AMPS	CIRCUITRY	INGRESS	NOTES
880107	880107S	12V DC	300A	Dual Pole	IP66/IP69k	4/0 input/output cables

48785 • 85A Electronic Relay/Switch

Fully solid-state with no moving parts to wear out that is completely sealed, ignition protected and designed to withstand vibration for harsh environments. Relays can be used in both high side and low side switching application and are suitable for high inrush demand circuits.

- Resistance: .005 Ω
- Control Current: .02A max
- Temperature Range: -40 °C to +85 °C
- On-Off Cycles: 20 million

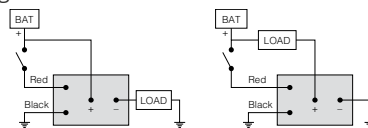

Additional information: Littelfuse.com/48785

PART NUMBERS BULK	PART NUMBERS BOXED	VOLTS	AMPS CONTINUOUS	AMPS INTERMITTENT	INGRESS	DIMENSIONS
48785	48785-BX	9-31V DC	85A	175A	IP67	3.0 x 5.0 x 2.9 in



Standard High Current Relays

6-36V DC • 35-200A • Continuous Duty Solenoids

- Hex nuts and lock washers are included.
- Steel housing mounting holes: 5/16 x 19/32," 2 13/64" on centers (7.9 x 15.1, 56.0mm).
- Plated steel housing available with optional PVC coating available to protect critical components from environmental hazards.

Additional information: Littelfuse.com/ContinuousDutySPST

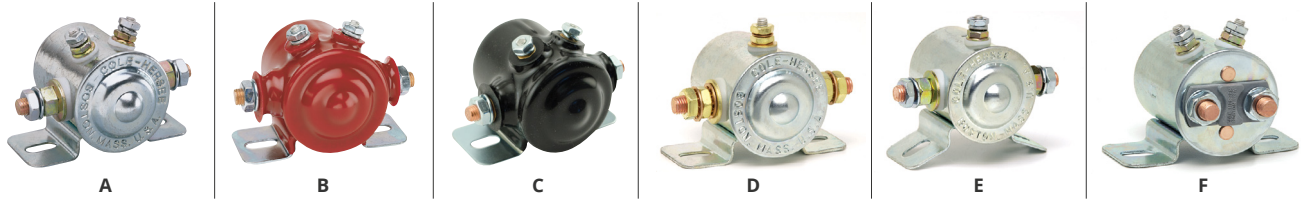

PART NUMBERS BULK	PART NUMBERS BOXED	PART NUMBERS RETAIL	VOLTS	AMPS	INSULATED / GROUNDED	CIRCUITRY	FORM / CONTACTS	CONTACT	TERMINALS LARGE	TERMINALS SMALL	PVC COATED UL LISTED IMAGE	DIAGRAM	NOTES
24080	24080-BX	-	36	85	Insulated	SPST	NO	Copper	Copper 5/16"-24	Steel 10-32"	A	1	
24063	24063-BX	-	24	85	Insulated			Copper				A	1
24063-08	24063-08-BX	-		85	Insulated			Copper				• • B	1
24214	24214-BX	-	200	Insulated	Silver			A				1	
-	24107-BX	-	85	Insulated	Copper			D				2	
24124	24124-BX	-	85	Grounded	Copper			D				4	
24115	24115-BX	-	85	Insulated	Copper			D				3	
24059	24059-BX	-	85	Insulated	Copper			A				1	
24059-15	-	-	85	Insulated	Silver			A				1	
24059-08	24059-08-BX	24059-08-BP	65	Insulated	Copper			• A				1	Intermittent rating: 750A Make, 100A Break 10 sec on, 30 min off
24117	24117-BX	-	85	Insulated	Copper			• B				1	
24117-01	24117-01-BX	24117-01-BP	65	Insulated	Copper			• • B				1	Intermittent rating: 750A Make, 100A Break 10 sec on, 30 min off
24213	24213-BX	24213-BP	200	Insulated	Silver			A				1	
24213-01	-	-	200	Insulated	Silver			A				1	Potted Coil - IP66
24213-03	-	-	200	Insulated	Silver			• C				1	Black Coating
24106	24106-BX	-	85	Grounded	Copper			D				4	
24106-07	24106-07-BX	-	85	Grounded	Copper			C				4	P/N, Date Code, Voltage ink stamped on surface
24082	24082-BX	-	85	Grounded	Copper			E				4	Curved Bracket
-	24420-BX	-	85	Insulated	Copper			F				5	
24097	24097-BX	-	6	85	Grounded			Copper				A	1

Wiring Diagrams

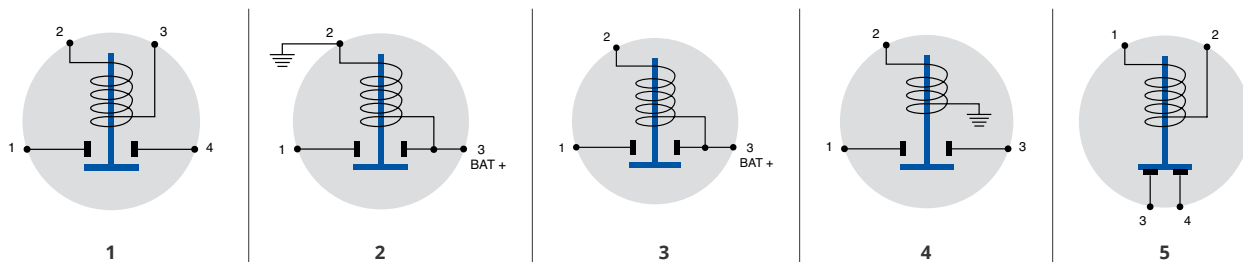

Standard High Current Relays

12V DC • Intermittent Duty Solenoids

- Hex nuts and lock washers are included.
- Steel housing mounting holes: 5/16 x 19/32," 2 13/64" on centers (7.9 x 15.1, 56.0mm).
- Phenolic housing mounting holes: 9/32 x 25/64," 2 7/64" on centers (7.1 x 9.9, 53.6mm).
- Solenoids available in phenolic, plated steel or PVC coated housings to protect critical components from environmental hazards.
- Resistor shorting circuit solenoids (p/n 24103/24021) feature a 3 that is normally open and becomes common with 1 and 4 when the solenoid is energized. Commonly used in engine starting applications.

Additional information: Littelfuse.com/IntermittentDutySPST

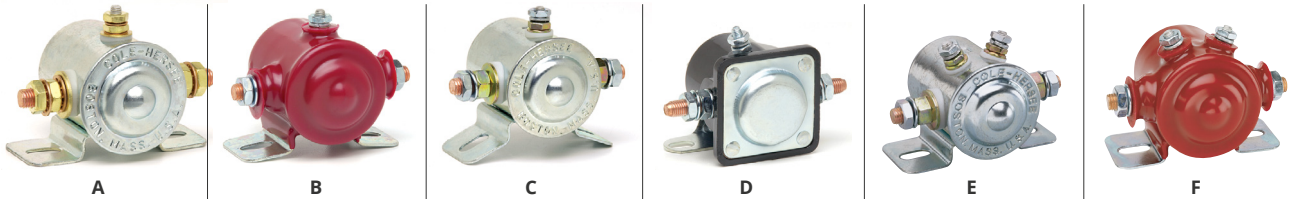

PART NUMBERS BULK	PART NUMBERS BOXED	VOLTS	AMPS MAKE	AMPS BREAK	DUTY CYCLE	INSULATED / GROUNDED	CIRCUITRY FORM / CONTACTS	HOUSING MATERIAL	CONTACT TERMINALS	SMALL TERMINALS	IMAGE DIAGRAM	NOTES	
24037	24037-BX	12	750	100	On: 10 sec Off: 20 min	Grounded	SPST NO	Plated Steel	Copper 5/16"-24 threads	Copper 10-32"	A	1	
24071	24071-BX					Grounded		PVC Coated			B	1	
24044	24044-BX					Grounded		Plated Steel			C	1	Curved Bracket
24022	24022-BX					Grounded		Phenolic			D	1	
24103	24103-BX					Grounded		Plated Steel			E	3	Resistor Shorting Circuit
24021	24021-BX					Grounded		Phenolic			D	3	Resistor Shorting Circuit
24047	24047-BX					Insulated		Plated Steel			E	4	
24076	24076-BX					Insulated		PVC Coated			F	4	
-	24046-BX					Insulated		Plated Steel			A	5	
24023	24023-BX					Insulated		Phenolic			D	2	
24008-03	-	24	120	On: 10 sec Off: 20 min	Insulated	SPST NO	Plated Steel	Copper 5/16"-24 threads	Copper 10-32"	E	-	Components shipped unassembled	
24008	24008-BX				Insulated		Plated Steel			E	-	Special spring for stronger contact return force	
-	24041-BX	6	100	On: 10 sec Off: 20 min	Insulated	SPST NO	Plated Steel			A	-		

Wiring Diagrams

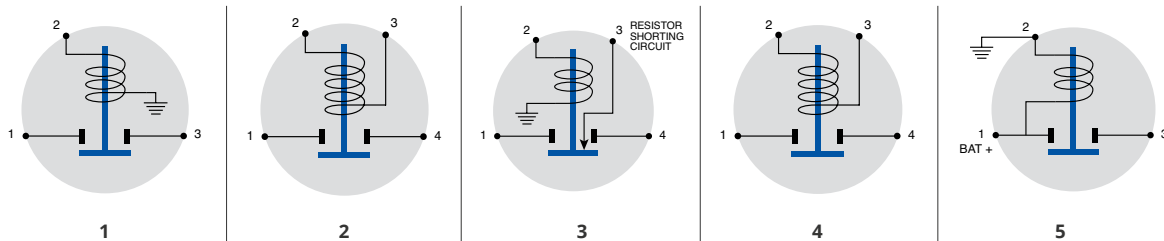

Standard High Current Relays

Continuous Duty Two Circuit Solenoids

Special applications: Forward and reverse systems in electric golf carts, garden tractors, fork lift trucks, winches, etc.

- Hex nuts and lock washers are included.
- Mounting holes: 5/16 x 19/32," 2 13/64" on centers (7.9 x 15.1, 56.0mm).

Additional information: Littelfuse.com/ContinuousDutyDPST

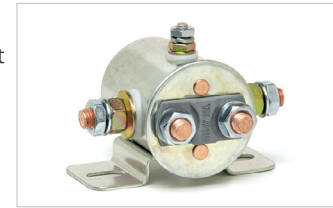

PART NUMBERS BULK	PART NUMBERS BOXED	VOLTS	AMPS NC	AMPS NO	COIL TYPE	CIRCUITRY	CONTACTS MATERIAL	CONTACTS THREADS	TERMINALS	DIAGRAM
24402	24402-BX	24	35	85	Insulated	DPST	Copper	5/16"-24	Steel 10-32"	1
24401	24401-BX	12	35	85	Insulated	DPST	Copper	5/16"-24	Steel 10-32"	1
24401-01	24401-01-BX	12	35	85	Grounded	DPST	Copper	5/16"-24	Steel 10-32"	2

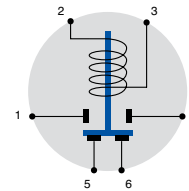

Diagram 1

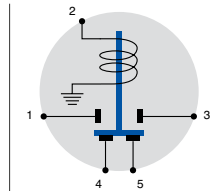

Diagram 2

100-225A • Heavy Service Plastic Body Solenoids

For starting small engines, including lawn tractors, golf carts and sweepers.

- Small ignition and ground terminals are 10-32 thread.
- Large contact terminals are 5/16" -24 thread.

Additional information: Littelfuse.com/PlasticBodyRelays



24848 - L-Bracket



24624-10 - F-Bracket



24612-10 - F-Bracket

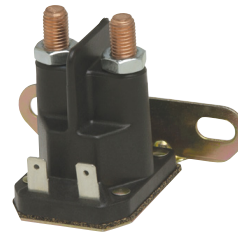

24512-10 - F-Bracket



24612-13 - F-Bracket

PART NUMBERS BULK	PART NUMBERS BOXED	PART NUMBERS OTHER	TYPE	VOLTS	MAX VOLTS	AMPS MAKE / BREAK	AMPS INRUSH	COIL TYPE	CIRCUITRY	FORM / CONTACTS	MOUNTING BRACKET	CONTACTS	COIL TERMINALS	DIAGRAM
24848	-	-	Continuous Duty	48	48	225	600	Insulated	SPST	NO	L-Bracket	Silver 5/16"-24	10-32 studs	1
24824-01	24824-01-BX	-		24	-	225	600	Insulated			L-Bracket	Silver 5/16"-24	10-32 studs	1
24812	24812-BX	-		12	14	225	600	Insulated			L-Bracket	Cooper 5/16"-24	10-32 studs	1
24812-01	24812-01-BX	-		12	14	225	600	Insulated			L-Bracket	Silver 5/16"-24	10-32 studs	1
24624-10	24624-10-BX	-		24	27	100	400	Insulated			F-Bracket	Silver 5/16"-24	10-32 studs	2
24512-10	24512-10-BX	-		12	14	100	400	Insulated			F-Bracket	Silver 5/16"-24	Blade	2
24612	24612-BX	24610-G10-BX		12	-	225	400	Insulated			L-Bracket	Silver 5/16"-24	10-32 stud	1
24612-10	24612-10-BX	-	Intermittent Duty	12	14	100	400	Grounded	F-Bracket	Silver 5/16"-24	10-32 stud	3		
24612-03	24612-03-BX	-		12	-	200	300	Insulated	L-Bracket	Cooper 5/16"-24	10-32 studs	2		
24612-13	24612-13-BX	-		12	14	200	300	Insulated	F-Bracket	Cooper 5/16"-24	10-32 studs	2		

Wiring Diagrams

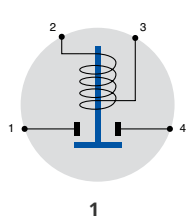

1

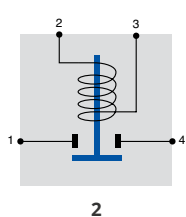

2

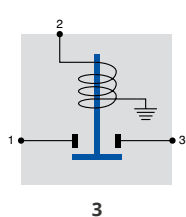

3

Reversing and Latching Solenoids

Forward & Reverse Relay Module • 70A

Ideal for tarp or lift applications. Also use on hoists, hatches, winches, snowplows, intake/exhaust fans, vehicle outriggers and other reversing applications. Module automatically reverses the direction of the motor when the appropriate control circuit is energized with a pulse from a control switch. Dynamic braking stops the motor when the switch returns to Off.

- Dimensions: 2.91"× 3.51" × 1.86" H (73.9 × 91.7 × 47.2mm)

Additional information: Littelfuse.com/24452



PART NUMBERS BULK	PART NUMBERS BOXED	VOLTS	AMPS INTERMITTENT	AMPS CONTINUOUS	INRUSH	SEALING	CONTACTS
24452	24452-BX	12V DC	70A (On: 5 min max, Off: 3 min)	50A	150A	IP67	Silver

Motor Reversing Intermittent Duty Solenoid • 12V DC • 70A

A combination of two solenoids in one package to reduce cost and maximize space savings while also providing simpler wiring.

- 75A Make/Break: 5 min On, 5 min Off
- 125A Make/Break: 30 sec On, 5 min Off
- 150A Make/Break: 0.5 sec On, 5 min Off

Additional information: Littelfuse.com/24450

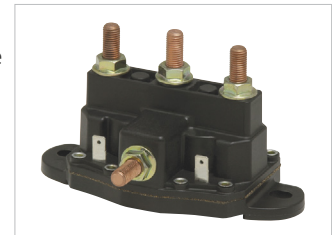

PART NUMBERS BULK	PART NUMBERS BOXED	PART NUMBERS RETAIL	VOLTS	AMPS	COIL TYPE	CIRCUITRY	CONTACTS	TERMINALS
24450	24450-BX	24450-BP	12V DC (14.5 max)	75-150A	Common Ground	DPDT	Copper	Two Blade Coil 5/16"-24 Large Studs
24450-02	-	-	24V DC	75-150A	Common Ground	DPDT	Copper	Two Blade Coil 5/16"-24 Large Studs

24200 • Standard High Current Latching Solenoid • 110A

Requires only a momentary application of coil power to operate. Minimal heat is generated, because the coil is de-energized when the solenoid is On.

- Continuous Duty Style (Rated at 110A carry only)

Additional information: Littelfuse.com/24200



PART NUMBERS BULK	PART NUMBERS BOXED	VOLTS	AMPS	COIL TYPE	CIRCUITRY	FORM / CONTACTS	HOUSING MATERIAL	CONTACTS	TERMINALS
24200	24200-BX	12V DC	110A	Insulated	SPDT	NO	Plated Steel	Copper 5/16"-24	Steel 10-32"

Plug-In Relays

Heavy Duty High Power and Micro Plug-In Relays

General purpose relays fit many vehicles and applications. Typical applications include: lighting, starting, horn, heating and cooling.

Standard ISO terminal footprint for Form A, Form C and Form 2A. Relays are available sealed and unsealed (unsealed 40 & 70A relays are supplied with snap-in brackets.)

- Dimensions: 2.91" × 3.51" × 1.86" H (73.9 × 91.7 × 47.2mm)

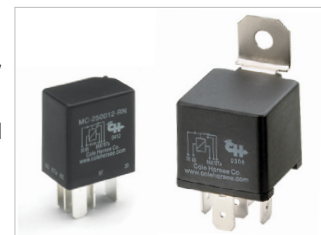

Additional information: Littelfuse.com/Plug-In-Relays

Specifications

- Pull-in voltage: 7.8V maximum at 12V DC, 15.6 V at 24V DC.
- Release voltage: 1.2 V minimum at 12V DC, 2.4 V at 24V DC.
- Temperature range: -40°C to 85°C
- Operational life: Electrical to 100,000 cycles
Mechanical to 10,000,000 cycles
- Contact Material: Silver alloy
- Dielectric strength: 500 V rms between coil and contact.
- Insulation resistance: 100 MΩ minimum (500V DC).
- Relays are rated based on a steady state resistive load. De-rate according to the type of load.
Motor load: Inrush can be 5 to 10 x steady state current.
Solenoid load: Inrush can be 10 to 20 x steady state current.
Incandescent lamp load: Inrush can be 10 to 15 x steady state current.
- Available with PCB terminals, contact Littelfuse for details.

Heavy Duty Relays • 40A at 12V DC

- Contact rating (Resistive load) at 20°C:
12V DC: Normally Open 40A, Normally Closed 30A
24V DC: Normally Open 20A, Normally Closed 15A
- Contact arrangement: Available as Form A (SPST), Form C (SPDT) and Form 2A (SPST, 2 terminals)
- Vibration resistance: 10-40Hz double amplitude 1.5mm

High Power Relays • 70A at 12V DC

- Contact rating (Resistive load) at 20°C:
12V DC: Normally Open 70A, Normally Closed 60A
24V DC: Normally Open 35A, Normally Closed 30A
- Contact arrangement: Available as Form A (SPST) and Form C (SPDT)
- Vibration resistance: 10-40Hz double amplitude 1.5mm

Micro Relays • 25A at 12V DC

- Contact rating (Resistive load) at 20°C:
12V DC: Normally Open 25A, Normally Closed 20A
- Contact arrangement: Available as Form A (SPST), and Form C (SPDT).
- Vibration resistance: 10-40Hz double amplitude 1.27mm

Part Numbering System

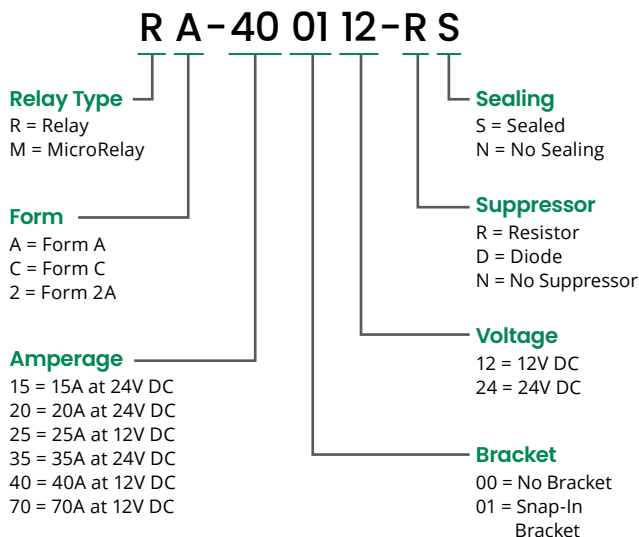

Part Numbers

PART NUMBERS BULK	PART NUMBERS BOXED	VOLTS	AMPS	RELAY TYPE	FORM	BRACKET	SUPPRESSOR TYPE	SEALED
R2-400112-RN	-	12	40	Relay	2	SPST	• Resistor	
RA-200024-DS	-	24	20	Relay	A	SPST	Diode	•
RA-400012-DS	-	12	40	Relay	A	SPST	Diode	•
RA-400112-DN	RA-400112-DN-BX	12	40	Relay	A	SPST	• Diode	
RA-400112-NN	RA-400112-NN-BX	12	40	Relay	A	SPST	• None	
RA-700112-RN	RA-700112-RN-BX	12	70	Relay	A	SPST	• Resistor	
RA-700112-DN	RA-700112-DN-BX	12	70	Relay	A	SPST	• Diode	
RA-700112-NN	RA-700112-NN-BX	12	70	Relay	A	SPST	• None	
RC-200024-DS	-	24	20	Relay	A	SPST	Diode	•
RC-200124-DN	RC-200124-DN-BX	24	20	Relay	C	SPDT	• Diode	
RC-200124-NN	RC-200124-NN-BX	24	20	Relay	C	SPDT	• None	
RC-200124-RN	RC-200124-RN-BX	24	20	Relay	C	SPDT	• Resistor	
RC-400012-DS	RC-400012-DS-BX	12	40	Relay	C	SPDT	Diode	•
RC-400112-DN	RC-400112-DN-BX	12	40	Relay	C	SPDT	• Diode	
RC-400112-NN	RC-400112-NN-BX	12	40	Relay	C	SPDT	• None	
RC-700112-DN	RC-700112-DN-BX	12	70	Relay	C	SPDT	• Diode	
RC-700112-NN	RC-700112-NN-BX	12	70	Relay	C	SPDT	• None	
RC-700112-RN	RC-700112-RN-BX	12	70	Relay	C	SPDT	• Resistor	
MC-250012-DN	-	12	25	Micro	C	SPDT	Diode	
MC-250012-NN	-	12	25	Micro	C	SPDT	None	
MC-250012-RN	-	12	25	Micro	C	SPDT	Resistor	

Plug-In Relays

Modular Relay Sockets • Bi-Stable Relay

Accepts Littelfuse brand relays and standard ISO relays.

- Modular – sockets dovetail together
- Accepts standard quick-connect terminals
- Easy mount bracket
- Constructed of rugged glass-filled polyamide
- Temperature range: -40°C to 85°C



Additional information: Littelfuse.com/Plugin-Relays

PART NUMBERS BULK	PART NUMBERS BOXED	RELAY TYPE AMPS	RELAY TYPE TERMINAL WIDTH	FORM	NOTES
99025	99025-BX	70A	.375"	A	Use with Tyco (AMP) terminals 280756 or 280755 (consult terminal manufacturers for full specs)
99026	99026-BX	40A	.250"	A or C	Use with Tyco (AMP) terminals 42281 or Ark-Les 3000H112A series (consult terminal manufacturers for full specs)

Time Delay and High Power Relays • 05903 Series **NEW**

The 05903 Series 24V 100A High-Current Relay is a normally open, armature relay that can be used in heavy trucks and commercial vehicles. Glass-fiber-reinforced housing and a compact form help ensure safe use in automotive applications. Configurations of this cube relay are available with 12V and 24V coil voltage ratings.



Additional information: Littelfuse.com/05903

PART NUMBERS BULK	VOLTS	CONTINUOUS AMPS	INTERMITTENT AMPS	CIRCUITRY	POLARIZATION
05903300	12	100	200	SPST	No
05903500	24	100	140	SPST	No



Plug-In Relay & MicroRelay Schematics and Terminal Layout















General purpose relays fit many vehicles and applications.

FORM	RELAY SCHEMATICS	RELAY TERMINAL LAYOUTS (40A .250" TERMINALS – 70A .375" TERMINALS)	MICRORELAY TERMINAL LAYOUTS
Form A	<p>RESISTOR OR DIODE (optional)</p>		
Form C	<p>RESISTOR OR DIODE (optional)</p>		
Form 2	<p>RESISTOR OR DIODE (optional)</p>		- Not Available -

DC Contactor Selection Guide · 20A-50A

Today's demanding commercial electric vehicles need robust power control and management. Developed specifically for eMobility and industrial applications, our DC contactor relays are available with continuous current ratings up to 500A and maximum voltage ratings up to 1800V DC. Browse our expanding line of DC contactors and partner with Littelfuse on your next design.

Application Key	 Transportation includes; truck, bus, material handling, construction and agriculture	 Stationary including; telecom power supplies, UPS, industrial and alternative energy
------------------------	--	--

CURRENT (A)	MAX VOLTS (V)	COIL VOLTS (V)	MOUNTING TYPE	AUX CONTACTS	POLARIZED	APPLICATIONS	PART NUMBER	PRODUCT IMAGE									
20	900	12	Bottom	No	Yes	 	DCNHR20PF12	A									
		24					DCNHR20PF12-01	B									
		48					DCNHR20PF24	A									
							DCNHR20PF24-01	B									
							DCNHR20PF48	A									
							DCNHR20PF48-01	B									
30	900	12	Bottom	No	Yes	 	DCNHR30PF12	A									
		24					DCNHR30PF12-01	B									
		48					DCNHR30PF24	A									
							DCNHR30PF24-01	B									
							DCNHR30PF48	A									
							DCNHR30PF48-01	B									
40	900	12	Bottom	No	Yes	 	DCNHR40PF12	A									
		24					DCNHR40PF12-01	B									
		48					DCNHR40PF24	A									
							DCNHR40PF24-01	B									
							DCNHR40PF48	A									
								DCNHR40PF48-01	B								
	1000		12	Bottom	No	Yes	 	DCNHS40NG12	C								
			24					DCNHS40NG24	C								
			48					DCNHS40NG48	C								
50	60	12	Side	No	No		DCNLM50NB12	D									
		24					DCNLM50NB24	D									
		48					DCNLM50NB48	D									
		60					DCNLM50NB60	D									
		12					Bottom	Yes	Bottom	Yes	Yes	 	DCNHR50QF12	E			
													No	DCNLEV50-BAN	G		
														Yes	DCNHR50PF12	F	
														No	DCNLEV50-BN	H	
													Yes	Side	Yes	DCNLEV50-BAS	I
															No	DCNLEV50-BASN	I
	Yes		DCNLEV50-BS	J													
	No		Bottom	Yes	DCNLEV50-BSN	J											
				Yes	DCNHR50QF24	E											
				No	DCNLEV50-CAN	G											
	24		Side	Yes	Side	Yes							Yes	 	DCNHR50PF24	F	
															No	DCNLEV50-CN	H
															Yes	DCNLEV50-CAS	I
															No	DCNLEV50-CASN	I
															Yes	DCNLEV50-CS	J
		No					DCNLEV50-CSN	J									
	48	Bottom	Yes	Bottom	Yes	Yes	 	DCNHR50QF48	E								
								No	DCNLEV50-EAN	G							
								Yes	DCNHR50PF48	F							
								No	DCNLEV50-EN	H							
								Yes	DCNLEV50-EAS	I							
No								DCNLEV50-EASN	I								
Yes								DCNLEV50-ES	J								
No								DCNLEV50-ESN	J								
No																	

PRODUCT IMAGES

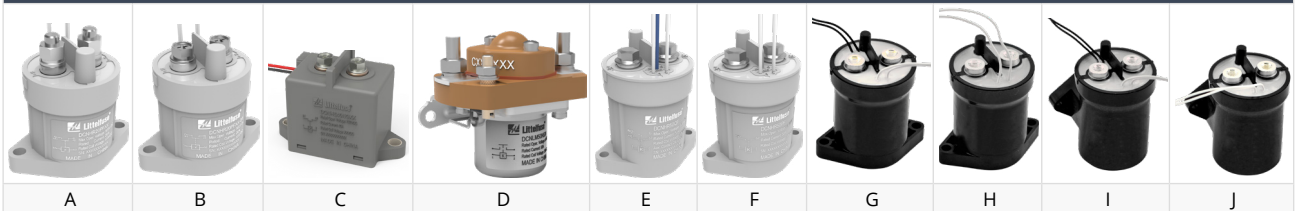

DC Contactor Selection Guide · 100A-125A

Application Key



Transportation includes; truck, bus, material handling, construction and agriculture



Stationary including; telecom power supplies, UPS, industrial and alternative energy

CURRENT (A)	MAX VOLTS (V)	COIL VOLTS (V)	MOUNTING TYPE	AUX CONTACTS	POLARIZED	APPLICATIONS	PART NUMBER	PRODUCT IMAGE				
100	60	12	Bottom	No	No	⊕ ⚡	DCNLR100NB12	A				
			Side				DCNLM100NB12	B				
		24	Bottom				DCNLM100NB12-01	C				
			Side				DCNLR100NB24	A				
		48	24				Bottom	DCNLM100NB24	B			
							Side	DCNLM100NB24-01	C			
			48				Bottom	DCNLR100NB48	A			
							Side	DCNLM100NB48	B			
								DCNLM100NB48-01	C			
							DCNLB100NB48	D				
		900	12				Bottom	Yes	Yes	⊕ ⚡	DCNHR100QF12	E
								No	No		DCNLEV100-BAN	F
	No			Yes	DCNHR100PF12	E						
	Yes			No	DCNLEV100-BN	G						
	Yes			Yes	DCNLEV100-BAS	H						
	No			No	DCNLEV100-BASN	H						
	Side			Yes	Yes	DCNLEV100-BS	I					
				No	No	DCNLEV100-BSN	I					
				24	Bottom	Yes	Yes	DCNHR100QF24	E			
						No	No	DCNLEV100-CAN	F			
						Yes	Yes	DCNHR100PF24	E			
					Side	Yes	No	DCNLEV100-CN	G			
	Yes		Yes			DCNLEV100-CAS	H					
	No		No			DCNLEV100-CASN	H					
	48		Bottom	Yes	Yes	DCNHR100QF48	E					
				No	No	DCNLEV100-EAN	F					
				Yes	Yes	DCNHR100PF48	E					
				Yes	No	DCNLEV100-EN	G					
				Yes	Yes	DCNLEV100-EAS	H					
				No	No	DCNLEV100-EASN	H					
Side			Yes	Yes	DCNLEV100-ES	I						
			No	No	DCNLEV100-ESN	I						
			1000	12	Bottom	Yes	Yes	⊕ ⚡	DCNHS100PG12	J		
						No	No	DCNHS100PG24	J			
		Yes				Yes	DCNHS100PG48	J				
		24		Side		No	No	DCNLJ125NB12	K			
Yes	Yes					DCNLJ125NB24	K					
Yes	Yes					DCNLJ125NB60	K					
60	Side	No	No	DCNLH125NB60	K							
		Yes	Yes	DCNLJ125PD12	K							
		Yes	Yes	DCNLJ125PD24	K							
110	24	Side	No	Yes	⊕ ⚡	DCNLJ125PD24	K					
			Yes	Yes	DCNLJ125PD60	K						
			Yes	Yes	DCNLJ125PD60	K						

PRODUCT IMAGES



DC Contactor Selection Guide · 150A-200A

Application Key



Transportation includes; truck, bus, material handling, construction and agriculture



Stationary including; telecom power supplies, UPS, industrial and alternative energy

CURRENT (A)	MAX VOLTS (V)	COIL VOLTS (V)	MOUNTING TYPE	AUX CONTACTS	POLARIZED	APPLICATIONS	PART NUMBER	PRODUCT IMAGE				
150	750	12	Side	No	Yes	Ⓢ ⚡	DCNEVT150-BS	A				
		24					DCNEVT150-CS	A				
		12	Bottom	No	Yes	Ⓢ ⚡	DCNEVT150-B	B				
		24					DCNEVT150-C	B				
	900	12 ~ 24	Bottom	Yes	Yes	Ⓢ ⚡	DCNHR150QFA	C				
				No	Yes		DCNHR150PFA	D				
200	60	12	Bottom	No	No	Ⓢ ⚡	DCNLR200NB12	E				
			Side				DCNLH200NB12	F				
			Bottom				DCNLM200NB12	G				
							DCNLM200NB12-01	H				
		24	Bottom	No	No	Ⓢ ⚡	DCNLR200NB24	E				
							DCNLB200NB24	I				
							DCNLH200NB24	F				
							DCNLJ200NB24	F				
			Side	No	No	Ⓢ ⚡	DCNLM200NB24	G				
							DCNLM200NB24-01	H				
							DCNLH200NB24-02	H				
							DCNLR200NB48	E				
	Top	No	No	Ⓢ ⚡	DCNLB200NB48	I						
					DCNLB200NB48-01	I						
					DCNLH200NB48	F						
					DCNLJ200NB48	F						
	Bottom	No	No	Ⓢ ⚡	DCNLM200NB48	G						
					DCNLM200NB48-01	H						
					Side	No	No	Ⓢ ⚡	DCNLR200NB60	E		
									DCNLB200NB60	I		
	110	12	Side	No	Yes	Ⓢ ⚡	DCNLH200PD12	F				
							DCNLH200PD24	F				
							DCNLJ200PD24	F				
		24	Side	No	Yes	Ⓢ ⚡	DCNLH200PD48	F				
60							Bottom	Yes	Yes	Ⓢ ⚡	DCNHR200QFA	C
								No	Yes		DCNHR200PFA	D

PRODUCT IMAGES

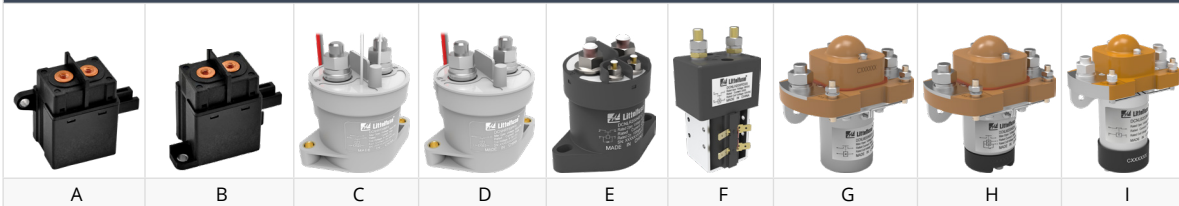

Application Note: Contactors for High Voltage Vehicles



DOWNLOAD

White Paper: DC Contactor Relays



DOWNLOAD

DC Contactor Selection Guide · 250A-500A

Application Key



Transportation includes; truck, bus, material handling, construction and agriculture



Stationary including; telecom power supplies, UPS, industrial and alternative energy

CURRENT (A)	MAX VOLTS (V)	COIL VOLTS (V)	MOUNTING TYPE	AUX CONTACTS	POLARIZED	APPLICATIONS	PART NUMBER	PRODUCT IMAGE
250	60	12	Side	No	No	⊗ ⚡	DCNLJ250NB12-01	A
	110	12	Side	No	Yes	⊗ ⚡	DCNLJ250PD12	B
	900	12 ~ 24	Bottom	Yes	Yes	⊗ ⚡	DCNHR250QFA	C
				No	Yes		DCNHR250PFA	D
		48 ~ 72	Bottom	Yes	Yes		DCNEV250-GA	C
				No	Yes		DCNEV250-G	F
		72	Bottom	Yes Normally Closed	Yes		DCNEV250-GB	F
				Yes	Yes		DCNEV250-FA	E
	No	Yes	DCNEV250-F	F				
	Yes Normally Closed	Yes	DCNEV250-FB	F				
300	900	12 ~ 24	Bottom	Yes	Yes	⊗ ⚡	DCNHR300QFA	G
No	Yes	⊗ ⚡	DCNHR300PFA	G				
350	1800	12	Bottom	Yes	Yes	⊗ ⚡	DCNEVT350-BA	H
				No	No		DCNEVT350-B	I
		24		Yes	Yes		DCNEVT350-CA	H
				No	No		DCNEVT350-C	I
400	60	12	Side	No	No	⚡	DCNLM400NB12	J
		24					DCNLB400NB24	K
		48					DCNLM400NB24	J
							DCNLM400NB24-01	L
		DCNLB400NB48					K	
		DCNLM400NB48					M	
	DCNLM400NB48-01	L						
	1800	Bottom	12	No	Yes	⊗ ⚡	DCNEVT400-B	N
			Yes	DCNEVT400-BA			N	
			No	DCNEVT400-C			O	
Yes			DCNEVT400-CA	O				
500	1800	Bottom	No	Yes	⊗ ⚡	DCNEVT500-B	P	
			Yes			DCNEVT500-BA	P	
			No			DCNEVT500-C	P	
			Yes			DCNEVT500-CA	P	

PRODUCT IMAGES

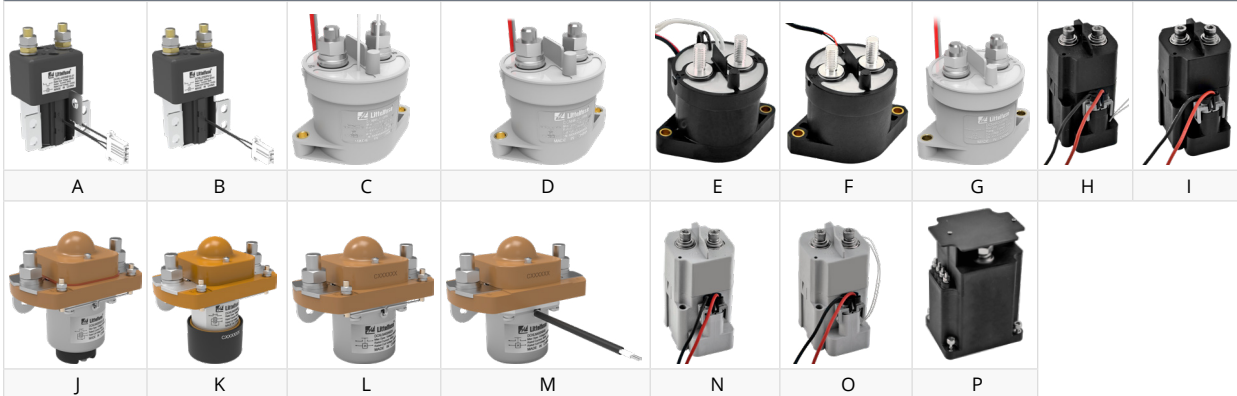

Battery & Master Disconnect Switches

Master Disconnect Switches are available for any application and suitable for 12V to 48V and up to 500A continuous (at 12V). Other features include: single or dual pole configurations, stem or flange mount, with lockout/tagout and lever or keyed actuators.

Lockouts & Tagouts

Lockouts and tagouts prevent operators, technicians and maintenance personnel from unanticipated power-ups that might cause injury or death.

According to OSHA, "A lockout device utilizes a positive means such as a lock to hold an energy isolating device in a safe position and prevent the energization of a machine." A tagout is a tag or seal that states 'Do not operate or remove this tag' and is signed by the person who places the tagout. Procedures specify that nobody but that person may remove the tagout.

A lockout on a battery switch not only keeps a vehicle safe, but also immobilizes it. A locked out vehicle is less vulnerable to battery drain or theft.



What is a Hencol Key?

Hencol is a Cole Hersee brand name used to describe our non-bitted common keys. Hencol keys are often used for ignition switches installed in forklifts or equipment that will have multiple operators. The non-bitted key allows any authorized user with a Hencol key to start and operator the vehicle.

The term Hencol is named after one of the Cole Hersee founders and is a truncation of his name, Henry Cole.



Battery Disconnect Switches

75920 Series • Sealed 400A

Protects vehicles against tampering, theft and battery drain. Switch protects from hazards during vehicle servicing and provides an effective emergency power cutoff. Can be used in both positive or in negative path applications. Built-in lockout satisfies OSHA requirements for an energy isolation device.

- 400A continuous at 12V DC – 3000A intermittent at 12V DC (15 seconds on 5 minutes off)
- Waterproof and dustproof to IP68 – switch can be mounted in exposed locations
- Built-in lockout satisfies OSHA requirements for an energy isolation device
- Large red knob is easy to operate with gloves
- Large divider on base prevents accidental shorting of high energy cables



Additional information: Littelfuse.com/75920

PART NUMBERS BULK	PART NUMBERS BOXED	PART NUMBERS RETAIL	VOLTS	AMPS	CIRCUITRY	INGRESS	MOUNTING METHOD	NOTES
75920	75920-BX	75920-BP	12-36V DC	200-400A	SPST	IP68	Through-Hole	Bezel marked "off - on" - Red Knob
75920-01	-	-						Bezel Marked "On/Off" - Yellow Knob
75920-05	75920-05-BX	-						Bezel marked "O - I" symbols
75920-10	75920-10-BX	-						Stainless Steel Hardware
75921-10	-	-						Stainless Steel Metric Hardware



75930 Series • 300A **NEW**

This dual-pole, single-throw (DPST) manual battery disconnect switch is constructed with a robust engineered polymer housing, offering a contemporary design that stands up to the harsh conditions typically found in commercial vehicle environments. Carrying an IP67/IPX9K rating, the switch is protected against dust, debris, and water. With a patented weld breaker safety feature and integrated lockout/tagout, the 75930-Series Battery Master Disconnect Switch with Auxiliary Contact is designed for safely cutting off battery power to all electrical systems aboard heavy-duty vehicles and equipment used in mining, agriculture, construction, and transportation.

Additional information: Littelfuse.com/75930

PART NUMBERS BULK	PART NUMBERS RETAIL	VOLTS	AMPS	CIRCUITRY	DESCRIPTION
75930-01	75930-01-BP	32V DC	300A	DPST	Auxiliary connections/integrated lockout/tagout - red
75930-02	75930-02-BP	32V DC	300A	DPST	Auxiliary connections/integrated lockout/tagout - yellow
75930-03	75930-03-BP	32V DC	300A	DPST	Auxiliary connections/integrated lockout/tagout - black



75940 Series • 300A **NEW**

This single-pole, single throw (SPST) manual battery disconnect switch is constructed with a robust engineered polymer housing, offering a contemporary design that stands up to the harsh conditions typically found in commercial vehicle environments. Carrying an IP67/IPX9K rating, the switch is protected against dust, debris, and water. With a patented weld breaker safety feature and integrated lockout/tagout, the 75940-Series Battery Master Disconnect Switch with Auxiliary Contact is designed for safely cutting off battery power to all electrical systems aboard heavy-duty vehicles and equipment used in mining, agriculture, construction, and transportation.

Additional information: Littelfuse.com/75940

PART NUMBERS BULK	PART NUMBERS RETAIL	VOLTS	AMPS	CIRCUITRY	DESCRIPTION
75940-01	75940-01-BP	32V DC	300A	SPST	Battery disconnect switch/integrated lockout/ tagout - red
75940-02	75940-02-BP	32V DC	300A	SPST	Battery disconnect switch/integrated lockout/ tagout - yellow
75940-03	75940-03-BP	32V DC	300A	SPST	Battery disconnect switch/integrated lockout/ tagout - black



Battery Disconnect Switches

TR Series • 500A Dual Pole

Cuts all battery power from vehicle electrical system, or for applications needing switching of two circuits, or both positive and negative.

- 500A continuous current rating for each of the two circuits (2x 4/0 input and 2x 4/0 output cables)
- Can be used to switch two vehicle voltage circuit simultaneously (12 & 24V DC)
- Built-in lockout satisfies OSHA requirements for an energy isolation device
- Ignition protected to SAE J1171 and ISO8846 for installation in a battery box or on vehicles carrying hazardous loads
- Ingress protection to IP67 and IP69k means that the switch can be mounted in exposed locations.



Additional information: Littelfuse.com/TRswitch

PART NUMBERS BULK	PART NUMBERS BOXED	VOLTS	AMPS	CIRCUITRY	INGRESS	MOUNTING METHOD	KNOB COLOR
880175	880175S	12-24V DC	500A	DPST	IP67 & IP69K	Surface Mount	Black
880175-0001	-						Red
880175-0002	-						Yellow



SR Series • 300A Flange Mount

Isolates high current DC circuits from battery sources. Available in multiple case designs with optional padlock capability.

- 300A continuous current rating
- Tin-plated copper studs provide maximum conductivity and lower contact resistance.
- Stainless steel hardware provides superior corrosion resistance.
- Ignition protected to SAE J1171 and ISO8846 for installation in a battery box or on vehicles carrying hazardous loads.



Additional information: Littelfuse.com/SRswitch

PART NUMBERS BULK	PART NUMBERS BOXED	PART NUMBERS RETAIL	VOLTS	AMPS (AT 12V DC)	CRANKING RATING (12 V DC, 30SEC)	INGRESS	MOUNTING METHOD	NOTES
880062	-	880062-BP	48V DC	300A	1250A (1 x 4/0 cable)	IP67 & IP69K	Through-Hole	-
880064	880064S	-	48V DC	300A	1250A (1 x 4/0 cable)	IP67 & IP69K	Surface-Hole	Lock-Out
880154	-	-	36V DC	600A	2500A (1 x 4/0 cable)	IP67 & IP69K	Surface-Hole	High-Cranking with Lock-Out
888842000A	-	-	12V DC	5A	-	-	Panel Mount	-

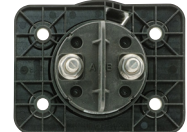

24505 Series NEW

The 24505 Series Battery Disconnect Switch Lockout Lever Kit allows you to use a padlock (not included) to securely lock a Cole Hersee brand lever-actuated metal case master battery disconnect switch in the OFF position. Disconnect switch lockout is required for certain applications to comply with lockout/tagout safety regulations.



PART NUMBERS BULK	PART NUMBERS BOXED	PART NUMBERS RETAIL	DESCRIPTION
24505	24505-BX	-	Metallic Lockout Lever Kit for 7.9 mm (5/16") Shackle Size
24505-01	-	-	Metallic Lockout Lever Kit for 7 mm Shackle Size
24505-02	-	24505-02-BP	Red Lockout Lever Kit for 7.9 mm (5/16") Shackle Size
24505-03	-	24505-03-BP	Yellow Lockout Lever Kit for 7.9 mm (5/16") Shackle Size
24505-04	-	24505-04-BP	Chrome Lockout Lever Kit for 7.9 mm (5/16") Shackle Size
80101-B	80101-B-BX	-	Manual Battery Disconnect Switch Lever with Chrome-Plated Finish
80101-D	-	-	Manual Battery Disconnect Switch Lever with Black Polyester Powder-Coated Finish

Battery Disconnect Switches

Compact • 100-150A • SPST • UP4X/IP43

08098700 is Standard Compact Manual Battery Disconnect Switch that features a removable handle with a plastic body. Rated to 100A continuous current this switch is ideal light-duty applications.

08099080 is an upgraded design with bigger contacts (M10) and improved components for heavier 150A current loads within the same compact dimensions, which make it one of the most popular products for 12V applications. This Manual Battery Disconnect Switch features a removable handle with a plastic body and rubber cap is included for protection while switch is removed from the socket.

Additional information: Littelfuse.com/ManualBatterySwitches



PART NUMBERS BULK	PART NUMBERS BOXED	PART NUMBERS RETAIL	VOLTS	AMPS	INTERMITTENT CURRENT	CIRCUITRY	INGRESS	MOUNTING	TERMINALS	TERMINAL HARDWARE	NOTES
08098700	08098700-BX	08098700-BP	12-24V DC	100A	500A at 5s	SPST	IP4X	Flange Mount	M8 Copper	Brass	-
08098780	08098780-BX	-	12-24V DC	150A	1000A at 5s	SPST	IP4X	Flange Mount	M10 Copper	Brass	-
08099080	08099080-BX	08099080-BP	12-24V DC	150A	1000A at 5s	SPST	IP43	Flange Mount	M10 Copper	Zinc-Plated Steel	Key Seal and Cap

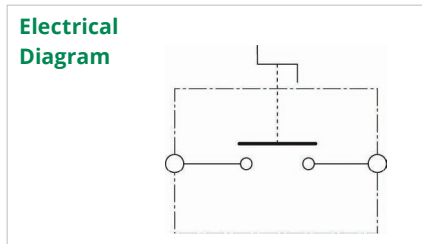
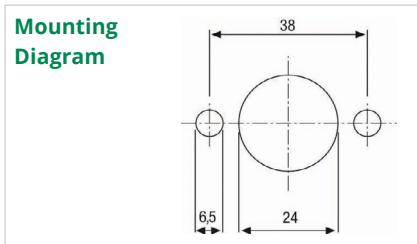

Push to Off • Compact • 150A • SPST • IP65 • M10 Studs

Manual Battery Disconnect Switch features a push button for fast push to off operation in the event where a quick reaction is necessary.

Rotate knob for ON. Switch status is indicated though a window on the top of the knob.

Additional information: Littelfuse.com/ManualBatterySwitches



PART NUMBERS BULK	PART NUMBERS BOXED	VOLTS	AMPS	INTERMITTENT CURRENT	CIRCUITRY	INGRESS	MOUNTING	TERMINALS	NOTES
08080200	08080200-BX	12-24V DC	150A	1200A at 5s	SPST	IP65	Through-Hole	M10 Silver Plated Copper	Push-to-Off

Marine Single Pole • 200A • SPST • IP67

Marine single pole main battery switch with a metal body. Heavy duty and resistant against corrosion, to be used on heavy trucks, farm tractors, buses, commercial vehicles end especially on boats.

Switch features 200A continuous current rating, removable handle, the "V" shape of the terminals allows for easy cable connections, and reduces risk of arcing. This switch is also RINA ISO-8846 approved and is equipped a white rubber protection cap.

Additional information: Littelfuse.com/ManualBatterySwitches



PART NUMBERS BULK	PART NUMBERS BOXED	VOLTS	AMPS	INTERMITTENT CURRENT	CIRCUITRY	INGRESS	MOUNTING	TERMINALS	NOTES
08081400	08081400-BX	24V DC	200A	1000A at 5s	SPST	IP67	Through-Hole	M10 Brass	Removable Key

Battery Disconnect Switches

250A • SPST • IP65/IP69k • M10 Studs

Manual battery switch with removable or fixed handle and available with weather protective boots.

08098800 - Base unit with removable handle

08098881 - Unit with removable handle and chain. Red and yellow rubber boots for weather protection and to help identify different applications. Interchangeable with Bosch 0341002003 switches

08098882 - Unit with fixed handle and integrated lock-out tag-out. Red, yellow and black rubber boots for weather protection and to help identify different applications. Latest design that does not require accessory for lockout tagout. Interchangeable with Bosch 0341002003 switches



Additional information: Littelfuse.com/ManualBatterySwitches

PART NUMBERS BULK	PART NUMBERS BOXED	VOLTS	AMPS	INTERMITTENT CURRENT	CIRCUITRY	INGRESS	MOUNTING	TERMINALS	TERMINAL HARDWARE	NOTES
08098800	08098800-BX	24V DC	250A	2500A at 3s	SPST	IP65	Flange Mount	M10 Copper	Zinc-Plated Steel	Removable Handle
08098881	08098881-BX	24V DC	250A	2500A at 3s	SPST	IP65/IP69k	Flange Mount	M10 Copper	Zinc-Plated Steel	Removable Handle with Chain, Keyhole Cover Red & Yellow Boots
08098882	08098882-BX	24V DC	250A	2500A at 3s	SPST	IP65/IP69k	Flange Mount	M10 Copper	Zinc-Plated Steel	Fixed Handle with Integrated Lock-Out Tag-Out, Black, Red & Yellow Boots

Mounting Diagram

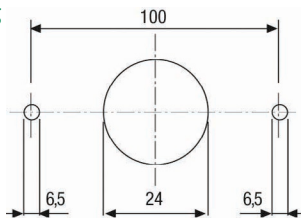

Electrical Diagram

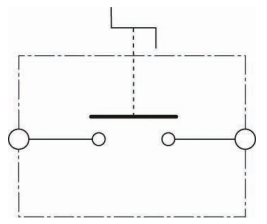

360° Rotation • 300A • SPST • IP65

Manual Battery Disconnect Switch features a fixed handle and metal body. The handle and contacts are designed with a unique 360° operation for activating the switch ON-OFF. The handle can be rotated either left or right to switch the circuit status. Switch is ON when handle is aligned with the terminals and OFF when perpendicular with the terminals.

Additional information: Littelfuse.com/ManualBatterySwitches



PART NUMBERS BULK	PART NUMBERS BOXED	VOLTS	AMPS	INTERMITTENT CURRENT	CIRCUITRY	INGRESS	MOUNTING	TERMINALS	NOTES
08010100	08010100-BX	24V DC	300A	1000A at 10s	SPST	IP65	Flange Mount	M10 Copper	360° Handle Rotation

Battery Disconnect Switches

350A • SPST • IP65/IP69k • M12 Studs

Manual switches with a removable or fixed handle and weather protective boot depending on part number selected.

08098900 - base unit with removable handle

08098980 - switch with removable handle with black boot and chain

08098981 - switch with fixed handle and black boot

Additional information: Littelfuse.com/ManualBatterySwitches

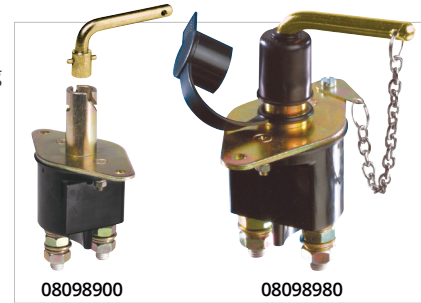

PART NUMBERS BULK	PART NUMBERS BOXED	VOLTS	AMPS	INTERMITTENT CURRENT	CIRCUITRY	INGRESS	MOUNTING	TERMINALS	TERMINAL HARDWARE	NOTES
08098900	08098900-BX	12-24V DC	350A	2500A at 3s	SPST	IP65	Flange Mount	M12 Silver plated Copper	Zinc-Plated Steel	Removable Handle
08098980	08098980-BX	12-24V DC	350A	2500A at 3s	SPST	IP65	Flange Mount	M12 Silver plated Copper	Zinc-Plated Steel	Removable Handle with Chain, Keyhole Cover
08098981	08098981-BX	12-24V DC	350A	2500A at 3s	SPST	IP65/IP69k	Flange Mount	M12 Silver plated Copper	Zinc-Plated Steel	Fixed Handle with Black Boot

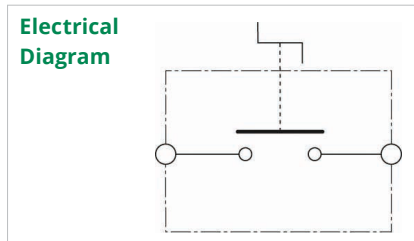
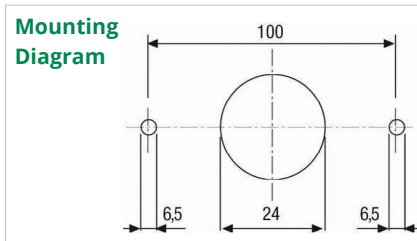

Dual Pole • 250-500A • DPST • IP67/IP69k

250A-500A Dual Pole manual battery master switch with removable or fixed handle. High performance design with industry leading mechanics and materials featuring modern advancements in the design evolution of manual battery disconnects.

- Smartkey allows handle to removable or fixed, locking it in either the OFF or ON position.
- Protective rubber cap with an auto-protection feature ensures protection when the handle is removed.

Additional information: Littelfuse.com/ManualBatterySwitches



PART NUMBERS BULK	PART NUMBERS BOXED	VOLTS	AMPS	INTERMITTENT CURRENT	CIRCUITRY	INGRESS	MOUNTING	TERMINALS	TERMINAL HARDWARE
08084300	08084300-BX	24V DC	250A	1000A at 3s	DPST	IP67/IP69k	Flange Mount	M10 Silver plated Copper	Nickel-Plated Brass
08084400	08084400-BX	24V DC	500A	1500A at 3s	DPST	IP67/IP69k	Flange Mount	M12 Silver plated Copper	Nickel-Plated Brass

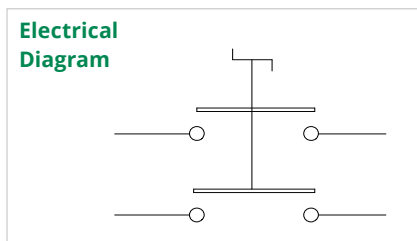

Single-Pole Battery Switches



2484 Series • Metal Body • 175A • SPST

Designed to disconnect the battery circuit on 6-36V DC systems.

- Two positions: Off-On
- Mounting Stem: Brass, 3/4" -16 thread with one of two lengths:
 - 23/32" (18.3mm) long, fits panels up to 3/16" (4.8mm) thick
 - 17/32" (13.5mm) long, fits panels up to 1/4" (6.4mm) thick
- Torque: Mounting Stem 20 ft/lb max - 3/8" nuts 70-90 in/lbs
- Electrical ratings on UL labels are conservative

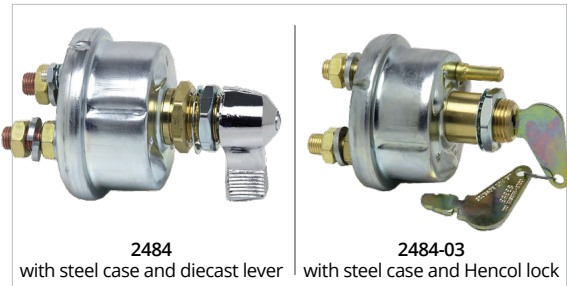

Additional information: Littelfuse.com/2484

PART NUMBERS BULK	PART NUMBERS BOXED	PART NUMBERS RETAIL	VOLTS	AMPS CONTINUOUS	AMPS INTERMITTENT	CASE	TERMINAL STUDS	MOUNTING STEM MATERIAL	MOUNTING STEM SIZE	ACTUATOR	CONTACTS	INDEXING PIN	O-RING SEAL	TERMINAL SEAL	UL LISTED	
2484	2484-BX	2484-BP	6V DC	40A	250A	Plated Steel	Two 3/8"-24	Brass	3/4-16 23/32 long	Lever	Copper	-	-	-	•	
2484-16	2484-16-BX	-	12V DC	20A	125A					Hencol Key	Silver	-	-	-	-	•
24024	-	-	6-36V DC	175A	800A (15s On-5m Off)					Lever	Brass	-	•	-	-	-
2484-A	2484-A-BX	-								Lever	Silver	-	-	-	-	
2484-06	2484-06-BX	-	3/4-16 17/32" long	1000A (15s On-5m Off)	Lever				Silver	-	•	•	-	-		
2484-09	2484-09-BX	-			Lever				Copper	-	-	-	-			
2484-02	2484-02-BX	-			Hencol Key				Silver	•	-	-	-			
2484-03	2484-03-BX	-			Hencol Key				Silver	•	•	-	-			
2484-19	2484-19-BX	-			1000A (30s On-5m Off)				Hencol Key	Silver	•	•	•	-		

Dimensions Inches [mm]

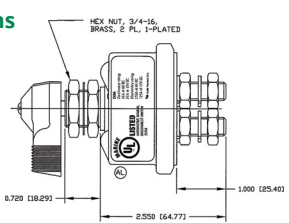

2-Position Lever Model

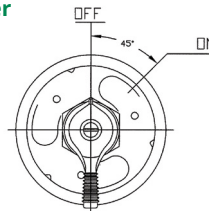

SPST Wiring Diagram

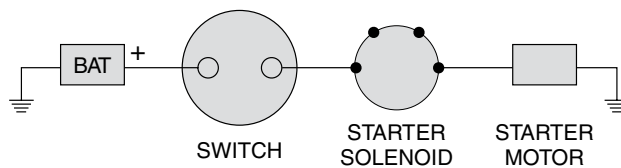

75908 Series • High Current • 300A • SPST

Designed to disconnect the battery circuit on 6-36V DC systems.

- Two positions: Off-On
- Mounting Stem: Brass, 3/4" -16 thread, 17/32" (13.5mm) long fits panels up to 1/4" (6.4mm) thick
- Torque: Mounting Stem 20 ft/lb max - 3/8" nuts 70-90 in/lbs

Additional information: Littelfuse.com/75908



PART NUMBERS BULK	PART NUMBERS BOXED	VOLTS	AMPS CONTINUOUS	AMPS INTERMITTENT	CASE	TERMINAL STUDS	MOUNTING STEM SIZE	ACTUATOR	CONTACTS	TERMINAL SEAL
75908	75908-BX	12V DC	300A	2000A (30s On-3m Off)	Plated Steel	Two 1/2"-20	3/4-16 17/32 long	Lever	Copper	•

Double-Pole Battery Switches

75900 Series • Metal Body • 125A • DPST

Designed to disconnect the battery circuit and the alternator or generator field circuit on 6-36V DC systems.

- Mounting Stem: Brass, 3/4" -16 thread with one of two lengths:
23/32" (18.3mm) long, fits panels up to 3/16" (4.8mm) thick
17/32" (13.5mm) long, fits panels up to 1/4" (6.4mm) thick
- Torque: Mounting Stem 20 ft/lb max - 3/8" nuts 70-90 in-lbs

Additional information: Littelfuse.com/75900



PART NUMBERS BULK	PART NUMBERS BOXED	VOLTS	AMPS CONTINUOUS	AMPS INTERMITTENT	CASE	TERMINAL STUDS	MOUNTING STEM MATERIAL	MOUNTING STEM SIZE	ACTUATOR	CONTACTS	INDEXING PIN	O-RING SEAL	TERMINAL SEAL	UL LISTED
75903	75903-BX	6-36V DC	125A	1000A (15s On-5m Off)	Plated Steel	Two 3/8"-24 Two 10-32	Brass	3/4-16 23/32 long	Chrome Lever	Brass	-	-	-	-
75904	75904-BX									Silver	-	-	-	-
75904-01	75904-01-BX							Hencol Key	Silver	•	•	•	-	
75904-02	75904-02-BX								Silver	•	-	-	-	
75904-03	75904-03-BX							Silver	•	•	-	-		
75912	75912-BX			750A (15s On-5m Off)		Four 3/8-24	-	3/4-16 23/32 long	Chrome lever	Silver	•	•	•	-

Note: 75912 has epoxy seal at case, mounting stem and indexing pin. Operating Temp: -40° to 85° F

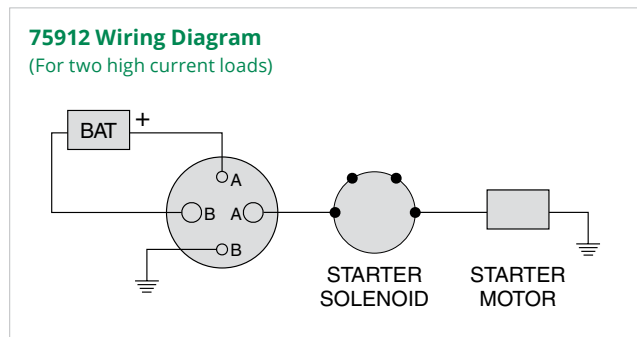
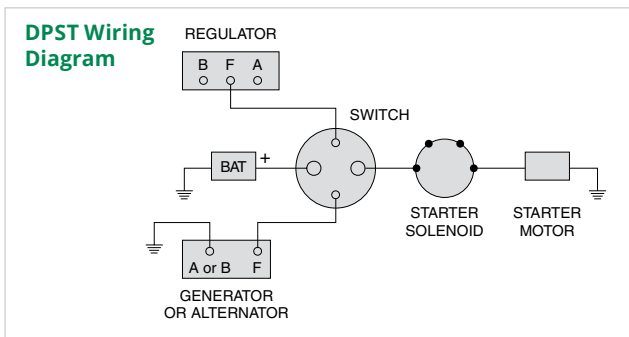

75907 Series • High Current • 300A • DPST

Designed to disconnect the battery circuit and the alternator or generator field circuit on 6-36V DC systems.

- Two positions: Off-On
- Mounting Stem: 3/4" -16 thread, 23/32" (18.3mm) long, fits panels up to 3/16" (4.8mm) thick
- Torque: Mounting Stem 20 ft/lb max - 3/8" nuts 70-90 in-lbs

Additional information: Littelfuse.com/75907



PART NUMBERS BULK	PART NUMBERS BOXED	VOLTS	AMPS CONTINUOUS	AMPS INTERMITTENT	CASE	TERMINAL STUDS	MOUNTING STEM SIZE	ACTUATOR	CONTACTS	INDEXING PIN	TERMINAL SEAL
75907	75907-BX	6-32V DC	300A	2000A (30s On-3m Off)	Plated Steel	Two 1/2"-20 & Two 10-32	3/4-16 23/32 long	Diecast Lever	Copper	•	•

Marine Battery Switches



M-284 Series • Brass Single-Pole • 175A • SPST

Designed to disconnect the battery circuit on 6-36V DC systems.

- Mounting Stem: Brass, 3/4" -16 thread, 1 13/32" (46.1mm) long fits panels up to 15/16" (23.8mm) thick
- Torque: Mounting Stem 20 ft/lb max - 3/8" nuts 70-90 in/lbs
- M-284-09BP includes Faceplate 82065
- Electrical ratings on UL labels are conservative

Additional information: Littelfuse.com/M-284

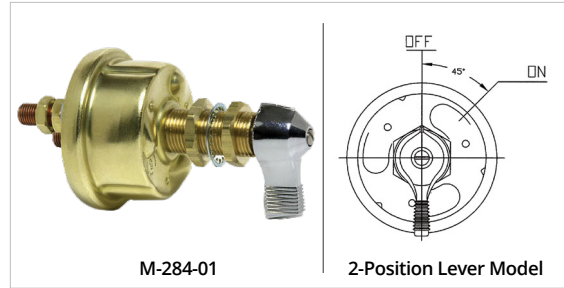

PART NUMBERS BULK	PART NUMBERS BOXED	PART NUMBERS RETAIL	VOLTS	AMPS CONTINUOUS	AMPS INTERMITTENT	CASE	TERMINAL STUDS	MOUNTING STEM MATERIAL	MOUNTING STEM SIZE	ACTUATOR	CONTACTS	O-RING SEAL	TERMINAL SEAL	UL LISTED
M-284	M-284-BX	M-284-BP	6-36 V DC	175 A	1000 A (15s On-5m Off)	Brass	Two 3/8"-24	Brass	3/4-16 1 13/32" long	Lever	Copper	-	-	-
M-284-01	M-284-01-BX	M-284-01-BP			800 A (15s On-5m Off)					Lever	Silver	-	-	•
M-284-02	M-284-02-BX	-			Dichromate Lever					Silver	•	•	-	
-	-	M-284-09-BP			Dichromate Lever					Silver	•	•	-	
M-284-26	-	-			Lever					Silver	-	-	-	
-	M-289-BX	-			Lever					Silver	-	-	-	

Note: M-284-09-BP Kit includes M-284-02 Switch and 82065 Faceplate.

M-290 Series • Brass Double-Pole • 125A • DPST

Designed to disconnect the battery circuit and the alternator or generator field circuit on 6-36V DC systems.

- Mounting Stem: Brass, 3/4" -16 thread with 1 13/32" (46.1mm) long, fits panels up to 15/16" (23.8mm) thick
- Torque: Mounting Stem 20 ft/lb max - 3/8" nuts 70-90 in-lbs
- M-290-05 is UL Listed to 707B

Additional information: Littelfuse.com/M-290DPST



PART NUMBERS BULK	PART NUMBERS BOXED	VOLTS	AMPS LARGE STUDS CONTINUOUS	AMPS LARGE STUDS INTERMITTENT	AMPS SMALL STUDS CONTINUOUS	CASE	TERMINAL STUDS	MOUNTING STEM MATERIAL	MOUNTING STEM SIZE	ACTUATOR	CONTACTS	O-RING SEAL	UL LISTED
M-290	M-290-BX	6-36V DC	125A	1000A (15s On-5m Off)	20A	Brass	Two 3/8"-24 & Two 10-32	Brass	3/4-16 1 13/32" long	Lever	Silver	•	•
M-290-05	M-290-05-BX	6-36V DC	125A	1000A (15s On-5m Off)	20A	Brass	Two 3/8"-24 & Two 10-32	Brass	3/4-16 1 13/32" long	Lever	Silver	•	•

Battery Selector Disconnect Switches



M-750 • Dual Battery Selector / Master Disconnect Switch

For any vehicle that needs to use two batteries where one battery is used for starting the engine, while the other is used to power auxiliary loads. This is a common situation in trucks, boats, RVs, police and rescue vehicles, and in ambulances and fire equipment.

A selector switch allows use of the first battery, the second battery, or both batteries simultaneously. This provides back-up starting power in an emergency. Either or both batteries can be selected to supply power.

These switches combine the functions of Battery Selector and Master Disconnect Switches to give four battery power options:

- Power cut off at the source
- Power On, Battery 2.
- Power On, Battery 1
- Power On, both Batteries

Electrical Ratings

Labeled UL 707B. Rating: 500A intermittent, 310A continuous, 6-36V DC.

Electrical ratings on UL labels are conservative. Use with either alternators or generators. Make before break design permits operation through the three On positions with the engines running. Engines should always be shut down before turning to Off. Wiring instructions are included.

Heavy-Duty Construction

- Vaporproof, weather-, dust- and corrosion-resistant.
- Durable, fracture-resistant high temperature plastic case, knob and insulator.
- Switches conform to USCG section 183.410 for ignition protection. Resistant to impact, and temperature extremes.
- Heavy duty copper stud terminals, with brass hexnuts. Can be surface mounted, or installed through a 3 5/16" diameter hole in the panel
- Dimensions: Flange: 6" (152.4mm) diameter, overall height 2 5/8" (66.7mm). Terminals: 3 copper studs, 3/8" (9.5mm) diameter.
- Alternator field disconnect circuit switch. Prevents possible alternator diode failure if the switch is accidentally turned to Off with the engines running.



M-750 Standard Switch

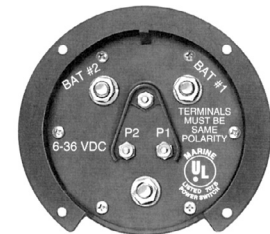

M-754 Back

M-752 has three small terminals in the middle are for connection to the pilot light circuit.

M-752 has two small terminals in the middle marked F1 and F2 for connection to the Alternator Field Disconnect circuit.

M-750 has no small terminals in the middle. Full wiring instructions are included.

Additional information: Littelfuse.com/M750

PART NUMBERS BULK	PART NUMBERS RETAIL CLAMSHELL	VOLTS	AMPS	TERMINAL	MOUNTING TYPE	SEALING	CERTIFICATION	PILOT CIRCUIT
M-750	M-750-BP	6-36V DC	500A intermittent 310A continuous	Copper Studs 3/8" (9.5mm)	Surface Mount Panel Mount (3 5/16" Ø hole)	Vaporproof, Weather-Resistant, Dust-Resistant, and Corrosion-Resistant	UL 707B	-
M-754	M-754-BP			Brass hexnuts				•

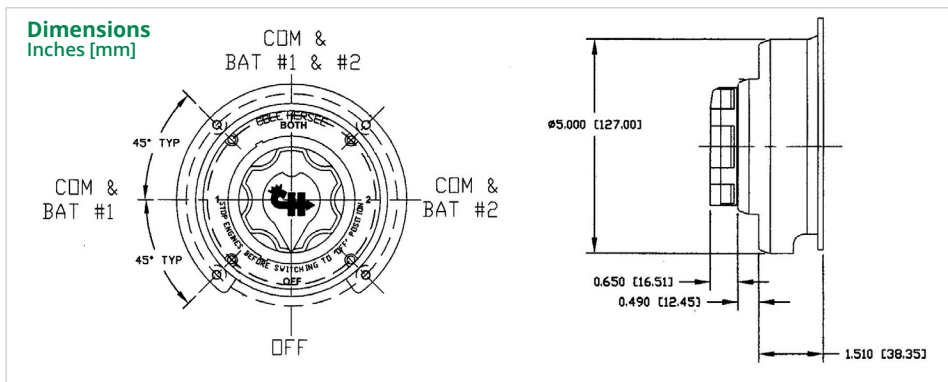

Metal Body Master Disconnect Switches - Accessories

Replacement levers, faceplates, terminal caps and lockout kits for Battery Disconnect Switches.



83353 Hencol Key



82065 Faceplate with On-Off Marking

PART NUMBERS BULK	PART NUMBERS BOXED	DESCRIPTION	NOTES
83353	83353-BX	Hencol Key	Replacement Hencol Key - Heavy gauge plated steel resists corrosion
82065	82065-BX	Faceplate	Polished aluminum with enamel finish - 2 1/2" (63.5mm) Ø
82065-02	82065-02-BX	Faceplate	With indexing hole - Polished aluminum with enamel finish - 2 1/2" (63.5mm) Ø

Battery Jumper Terminals and Feeder Studs

Battery Jumper Terminals are used to make easily-accessible battery connections, inside or outside the vehicle. They can be used individually or in pairs and are easy to install. Featuring solid brass posts, including a brass hexnut and lockwasher.

Feeder Studs bring power through bulkheads or firewalls and feature an impact-resistant plastic insulator/mounting bushing.



46210-02



46210-03



46211-R



46211-01

PART NUMBERS BULK	PART NUMBERS BOXED	VOLTS	DESCRIPTION	COLOR	TERMINAL/STUD SIZE	DIMENSIONS	NOTES
46210-02	46210-02-BX	6-48V DC	Terminal Post	Red	Terminal: 13/16" (20.6mm) Ø 1-1/8" (29.9mm) long	-	Replacement Cap: 97846-A
46210-03	46210-03-BX	6-48V DC	Terminal Post	Black			Replacement Cap: 97846-B
46211-R	46211-R-BX	6-36V DC	Feeder Stud	Red	Two 3/8" -16 threads 5/8" (15.9mm) long	1 17/64" (32.1mm) Ø 5/8" (15.9mm) long	-
46211-01	46211-01-BX	6-36V DC	Feeder Stud	Black			

JBPT Single Stud Junction Blocks

Connection points for distribution of power in feed-thru and non-feed-thru styles. Simplifies cabling and serves as convenient tap points. Stainless steel studs of various threads and sizes, in red or black thermoplastic body. 3/8" zinc-plated steel studs have electrical rating of 400A and low resistance due to large contact area. High installation torque values allow the use of large cable sizes for high current applications.

PART NUMBERS BULK	COLOR	FEED TYPE	STUD SIZE	MOUNTING BASE
JBPT2P01ZXR	Red	Feed-Thru	1/2"-13	69.8 x 47.6mm
JBPT2N02ZXB	Black	Non-Feed-Thru	1/2"-13	69.8 x 47.6mm
JBPT3P01ZXB	Black	Feed-Thru	3/8"-18	52.4 x 19.1mm
JBPT3P02ZXB	Black	Non-Feed-Thru	3/8"-18	52.4 x 19.1mm
JBPT3N03ZXB	Black	Feed-Thru	3/8"-18	-
JBPT0001Z	Red	Feed-Thru	-	-



Application and Advantages

Utilizing battery disconnect switches, designers have many safety, security, and cost-saving benefits.

Short-Circuit Protection



Road salt corrosion is becoming an increasingly common problem. In the event corrosion leads to a short circuit resulting in a fire, a battery switch can be activated to prevent further damage to the vehicle or injury to occupants. On an unattended vehicle, chaffed or damaged wires can short circuit causing a thermal event that can destroy the equipment, vehicles around it, or the building where it is parked.



Safety and Security



Mechanics can ensure a vehicle electrical system is shut down by operating a battery switch. With the addition of built-in or accessory lock out tag out, the mechanic can ensure the vehicle cannot be energized or started during service. Another benefit of lockout/tagout is that owners can secure a switch with a padlock making it difficult for thieves, vandals, or unauthorized users to operate the equipment.



Save Costs



Parasitic loads (power consumed even when the equipment is shut off) can drain a battery on equipment stored for long periods of time. By disconnecting the battery, the electrical system will not have any parasitic loads that can drain the battery and cause premature failure. Using a battery switch can help prevent costly battery replacements and ensure that the battery is fully charged for the next job.



Principles of Operation and Selection Criteria

Installation and Operation

Battery disconnects are installed in an electrical system between the battery and loads. The switch should be placed as close to the battery as possible while providing the operator with easy access to the actuator so they can quickly and completely power down the vehicle or equipment.

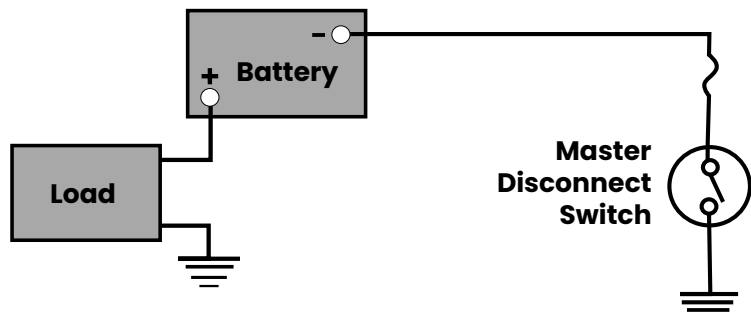
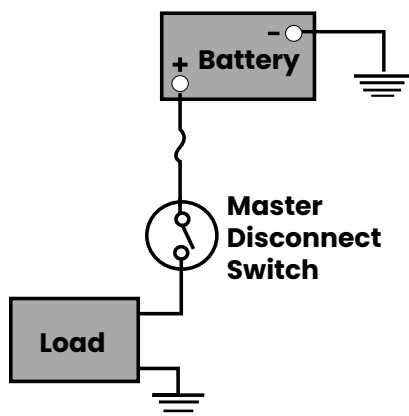

Battery Disconnect Switch Selection

Identify the duty rating of the switches based on following parameters:

- Compare the rating of the alternator to the continuous current rating of the switch.
- Compare the starting current requirement during cold cranking to the intermittent current rating of the switch.
- Compare the short circuit current and time for the battery to the intermittent current rating of the switch.

Cable and Stud Size

- The cable size, or gauge, has a significant effect on the performance of the switch. By extracting heat from the switch, larger cables will allow the switch to handle larger currents and last longer. The rating of the switch is based on minimum wire size. Please refer to the switch datasheet to understand how the switch is rated.
- It is important to match the terminal diameter of the switch to the cable size and ring terminal size.

Switch Mounting Location / Environmental factors

- Mounting location of the switch often determines the required level of sealing for the switch. If the switch will be mounted in an exposed location, consideration for sealed IP67 or IP69K should be given. If the switch is placed on in a protected location, then a splash-proof rated switch may only be needed.
- Plastic switches are less susceptible to corrosion issues than metal switches. For rugged applications, they are often just as robust and reliable as metal body switches especially for applications where the switch may be exposed to corrosive chemicals (such as road salt brines or acid wash).
- If the switch is mounted near a DPF (diesel particulate filter) subject to burn off, make sure the temperature rating of the switch is able to sustain operation without excessive derating.
- Stainless steel hardware for electrical connections greatly helps in preventing corrosion.

Mounting Method

- Flange-mounted switches have a more finished appearance on the outside as they integrate the bezel and the switch markings, not requiring an external faceplate. However, they require a larger and sometimes irregular mounting hole as well as separate screws to mount.
- Shaft-mount switches are easier to mount as they require one or two drillable round holes. However, in most cases, they take up more room behind the panel.

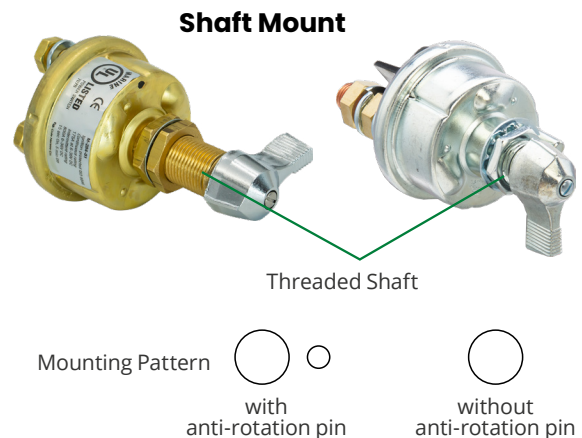
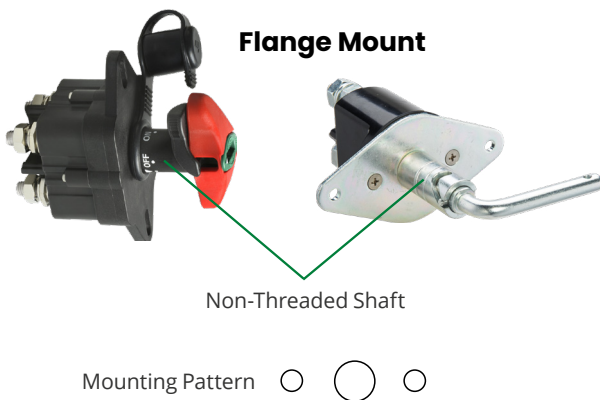

Ingress Protection

Harsh Environments and Ingress Protection Ratings

Environmental factors play a huge role in a product's ability to do its job and survive the lifetime of the equipment. Ingress Protection, or IP, indicates the degree of protection of a power distribution module. IP ratings are a measure of how resistant a part is to environmental contaminants such as debris, dust, and water. IP rating selections should be based on where the PDM will be mounted and what type of environment the equipment will be used in.

The numbers following IP represent levels of sealing and can range from no sealing (IP00) to protection against dust and continuous immersion in water (IP68). The table below provides a description of the protection at each level.

FIRST DIGIT – SOLID Degree of protection against solid objects	SECOND DIGIT – LIQUID Degree of protection against water
 <p>1 Protected against a solid object greater than 50mm.</p>	 <p>1 Protected against vertically falling water drops.</p>
 <p>2 Protected against a solid object greater than 12.5mm.</p>	 <p>2 Protected against vertical water drops when enclosure tilted up to 15 degree angle.</p>
 <p>3 Protected against a solid object greater than 2.5mm.</p>	 <p>3 Protected against spraying water from up to a 60 degree angle.</p>
 <p>4 Protected against a solid object greater than 1.0mm.</p>	 <p>4 Protected against splashing water.</p>
 <p>5 Dust Protected. Prevents ingress of dust sufficient to cause harm.</p>	 <p>5 Protected against water jets.</p>
 <p>6 Dust tight. No ingress of dust.</p>	 <p>6 Protected against powerful water jets.</p>
<p>Example IP67</p> <p>Dust tight. No ingress of dust. Protected against effects of temporary submersion in water.</p>	 <p>7 Protected against the effects of temporary immersion in water between 15cm and 1m for 30 minutes.</p>
	 <p>8 Protected against the effects of continuous immersion in water under conditions agreed between manufacturer and user.</p>
	 <p>9k Protected against close-range high pressure, high temperature spray downs.</p>

Ignition Switches



Littelfuse offers the broadest range of 12V to 48V Ignition Switches which are suitable for any application. Variations include those with plastic or traditional metal body, lever-actuated, tumbler keyed, or patented Hencol keyed.

Benefits of Anti-Restart Feature

Several ignition switches, including the 95060 series, feature an anti-restart mechanism. An operator can damage the starter motor if the ignition switch is inadvertently turned the when the engine is running. This can happen in noisy environments where it may be difficult to hear the engine. The switch must be turned to the Off position before the start circuit can be re-energized.

95060 – Not Just for Ignitions

The 95060 series is widely used in ignition systems. However, there are many other applications where a keyed, water-resistant rotary switch (two, three, or four positions) is required for 12V, 24V, or 36V systems

What is a Hencol Key?

Hencol is a Cole Hersee brand name used to describe our non-bitted common keys. Hencol keys are often used for ignition switches installed in forklifts or equipment that will have multiple operators. The non-bitted key allows any authorized user with a Hencol key to start and operator the vehicle.

The term Hencol is named after one of the Cole Hersee founders and is a mash-up of their name, Henry Cole.

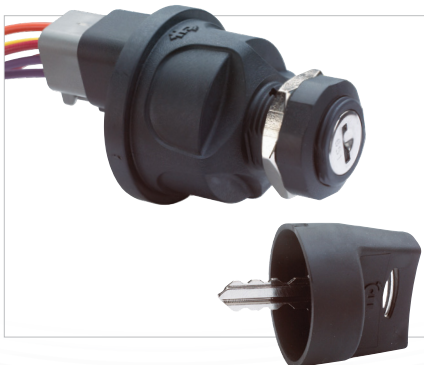

Sealed Ignition Switches

95060 Series • 12-48V DC

Durable engineering thermoplastic construction withstands impact, and will not corrode, even on continual exposure to road salt. 95060 switches have integrated Deutsch-type connector for easy installs.

- Voltages: 10A at 12V, 5A at 24V, 3A at 36V and 2A at 48V
- Options: key boot, anti-restart, or spring return
- Sealing: contacts are sealed front and back to IP67 standard, with connector (part number 31101) installed
- Ignition Protection: Tested to SAE J259 and UL-Recognized
- Deutsch connectors & Wires Part Number: 31101 (included in -50, -51 and -60 items)
- Actuators: single or multiple key codes, lever, knob or D-shaft.
 - Keyed switches ship with 2 keys (removable in Off position) Replacement blanks: 83451-6 (600 series) or 83451-7 (700 series).
 - CH601: Single tumbler code - all locks are identical
 - Mixed: 200 random key codes
 - 10 code: 10 random key codes
 - Lever: Chrome-plated diecast lever part number 81254
 - Soft touch knob: part number 81397
 - D-shaft: 1/4" D-shaft to accept customer's actuator



Additional information: Littelfuse.com/95060

PART NUMBERS BULK	PART NUMBERS BOXED	PART NUMBERS RETAIL	TOTAL	Positions				ACTUATOR	KEY CODE	KEY BOOT	HARNES	SPRING RETURN	ANTI-RESTART	SWITCH WITH HARNESS (P/N 31101)	REPLACEMENT ACTUATOR OR KEY BLANK
				1	2	3	4								
95060	95060-BX	-		Acc	Off	Ign/Acc	Start	keys	Mixed	•	-	•	-	-	83451-6 or 83451-7
95060-01	95060-01-BX	-		Acc	Off	Ign/Acc	Start	keys	Mixed	•	-	•	•	-	83451-6 or 83451-7
95060-02	-	-		Acc	Off	Ign/Acc	Start	keys	Mixed	•	-	-	-	-	83451-6 or 83451-7
95060-23	95060-23-BX	-		Acc	Off	Ign/Acc	Start	keys	CH601	-	-	•	-	-	83451-6
95060-24	-	-		Acc	Off	Ign/Acc	Start	keys	CH601	-	-	•	-	-	83451-6
95060-34	95060-34-BX	-		Acc	Off	Ign/Acc	Start	keys	10 Codes	-	-	•	-	-	83451-6 or 83451-7
-	-	95060-50-BP	4	Acc	Off	Ign/Acc	Start	keys	10 Codes	•	•	•	-	95060	83451-6 or 83451-7
-	95061-BX	-		Acc	Off	Ign/Acc	Start	Lever	-	-	-	•	-	-	81254
-	95061-50-BX	-		Acc	Off	Ign/Acc	Start	Lever	-	-	•	•	-	95061	81254
95061-01	-	-		Acc	Off	Ign/Acc	Start	Lever	-	-	-	•	•	-	81254
95062-10	-	-		Acc	Off	Ign/Acc	Start	Knob	-	-	-	•	-	-	81397
-	95062-50-BX	-		Acc	Off	Ign/Acc	Start	Knob	-	-	•	•	-	95062-10	81397
95060-03	95060-03-BX	-		Off	Ign/Acc	Start	-	keys	Mixed	•	-	•	-	-	83451-6 or 83451-7
-	-	95060-60-BP		Off	Ign/Acc	Start	-	keys	Mixed	•	•	-	-	95060-03	83451-6 or 83451-7
95060-04	95060-04-BX	-		Off	Ign/Acc	Start	-	keys	Mixed	•	-	•	•	-	83451-6 or 83451-7
95060-21	-	-		Off	Ign/Acc	Start	-	keys	10 Codes	•	-	•	-	-	83451-6 or 83451-7
95060-26	-	-		Off	Ign/Acc	Start	-	keys	CH601	•	-	•	-	-	83451-6 - no logo
95060-36	-	-		Mom On 1	Off	Mom On 2	-	keys	CH545	-	-	•	-	-	Yale Y13
95060-43	-	-	3	Mom On 1	Off	Mom On 2	-	Keys	Mixed	•	-	•	-	-	83451-6 or 83451-7
95061-04	95061-04-BX	-		Off	Ign/Acc	Start	-	Lever	-	-	-	•	•	-	81254
95061-05	-	-		Off	Ign/Acc	Start	-	Lever	-	-	-	•	•	-	81254
-	95061-60-BX	-		Off	Ign/Acc	Start	-	Lever	-	-	•	•	•	95061-04	81254
95061-36	95061-36-BX	-		Mom On 1	Off	Mom On 2	-	Lever	-	-	-	•	-	-	81254
95062-13	-	-		Off	Ign/Acc	Start	-	knob	-	-	-	•	-	-	81254
95060-07	95060-07-BX	-		Off	Ign/Acc	-	-	keys	Mixed	•	-	-	-	-	83451-6 or 83451-7
95060-29	-	-		Off	Ign/Acc	-	-	keys	CH601	•	-	-	-	-	83451-6
95061-07	-	-	3	Off	Ign/Acc	-	-	Lever	-	-	-	-	-	-	81254
95062-17	-	-		Off	Ign/Start	-	-	Knob	-	-	-	-	-	-	81397
-	95062-57-BX	-		Off	Ign/Start	-	-	Knob	-	-	•	-	-	95062-17	81397

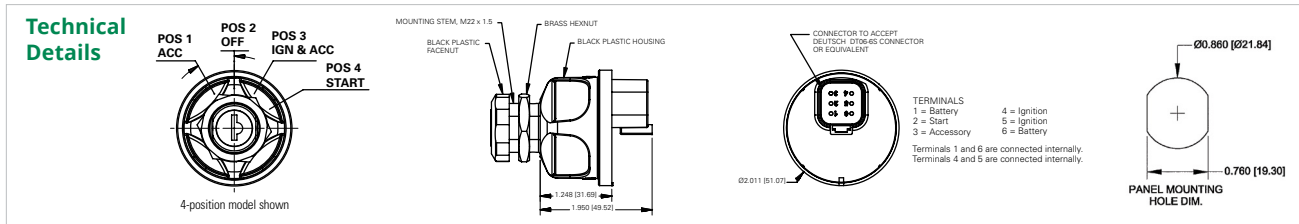

Heavy Duty Ignition Switches

956 Series • General Purpose Metal Body

Dependable diecast zinc housing switches with an array of options for every application. Switches mount through the panel and have lever action or are keyed (hencol key or coded tumbler lock). On keyed switches the key is removable at Off position only.

- Terminal Options:
 - Brass blade 1/4" (6.4mm) wide accept Delphi (Packard) connector 2962912 or equivalent
 - Screw Terminals include lock washers
- Mounting Sizes
 - 1"-24 bushings fit panels .030" - .090" (.76mm - 2.3mm)
 - 3/4"-24 bushings fit panels .060" - .110" (1.5mm - 2.7mm)

Additional information: Littelfuse.com/IgnitionSwitches



Coded tumbler lock
with 2 keys



Patented Hencol lock
with 2 keys (83357)



Short handle lever
(81254)



Military Lever
(956-5109)

PART NUMBERS BULK	PART NUMBERS BOXED	PART NUMBERS RETAIL	AMP RATING (12V DC)				Positions				ACTUATOR / KEY TYPE	TERMINALS	SPRING RETURN ANTI-RESTART GROUND TERMINAL	SILVER CONTACT SHUTTER LOCK GASKET O-RING	Seal Type	BUSHING SIZE	REPLACEMENT KEY BLANK		
			ACC	IGN	START	GROUND	TOTAL	1	2	3								4	
956-4100	956-4100-BX	-	10	10	5	1	Acc	Off	Ign/Acc	Ign/start	Coded	4 blade	•	-	-	•	1"-24	Unavailable - OB	
956-4107	956-4107-BX	-	10	10	5	1	Acc	Off	Ign/Acc	Ign/start	Hencol	4 screw	•	-	-	•	1"-24	83357	
-	956-4111-BX	-	10	10	5	1	Acc	Off	Ign/Acc	Ign/start	S. Lever	4 blade	•	-	-	-	1"-24	81254	
956-4113	-	-	30	10	5	-	Acc	Off	Ign/Acc	Ign/start	Hencol	4 blade	•	-	-	•	1"-24	83357	
956-4124	956-4124-BX	-	10	10	5	1	Acc	Off	Ign/Acc	Ign/start	S. Lever	4 screw	•	-	-	•	1"-24	81254	
956-4138	956-4138-BX	-	30	20	10	-	4	Acc	Off	Ign/Acc	Ign/start	Coded	4 blade	•	-	-	-	1"-24	Unavailable - OB
956-4141	956-4141-BX	-	30	20	10	-	Acc	Off	Ign/Acc	Ign/start	Hencol	4 screw	•	-	•	•	1"-24	83357	
956-4154	956-4154-BX	-	10	10	5	1	Acc	Off	Ign/Acc	Ign/start	Coded	5 screw	•	•	-	•	1"-24	Unavailable - OB	
956-4307	956-4307-BX	-	10	10	5	1	Acc	Off	Ign/Acc	Ign/start	Hencol	4 screw	•	-	-	•	3/4"-24	83357	
956-4311	956-4311-BX	-	10	10	5	1	Acc	Off	Ign/Acc	Ign/start	Coded	4 blade	•	-	-	-	3/4"-24	Unavailable - OB	
956-9100	956-9100-BX	-	10	5	5	1	Fuel	Off	Ign/Acc	Ign/start	Hencol	5 screw	•	-	-	•	1"-24	83357	
956-3122	956-3122-BX	-	10	10	5	-	Off	Ign/Acc	Ign/start	-	Coded	5 screw	•	•	-	•	1"-24	Unavailable - OB	
956-3124	956-3124-BX	-	10	10	5	-	Off	Ign/Acc	Ign/start	-	S. Lever	5 screw	•	•	-	•	1"-24	81254	
956-3125	956-3125-BX	-	30	10	10	-	Off	Ign/Acc	Ign/start	-	Coded	4 screw	•	•	-	•	1"-24	Unavailable - OB	
956-3126	956-3126-BX	956-3126-BP	10	10	5	-	Off	Ign/Acc	Ign/start	-	Coded	4 screw	•	•	-	•	1"-24	83357	
956-3127	956-3127-BX	-	30	10	10	-	Off	Ign/Acc	Ign/start	-	S. Lever	3 screw	•	•	-	•	1"-24	81254	
956-3135	-	-	10	10	5	1	3	Off	Ign/Acc	Ign/start	-	S. Lever	5 screw	•	-	-	-	1"-24	n/a
956-5109	956-5109-BX	-	20	10	10	-	Off	Ign/Acc	Ign/start	-	Mil. Lever	4 screw	•	-	-	•	1"-24	n/a	
956-5124	-	-	10	10	5	-	Off	Ign/Acc	Ign/start	-	Hencol	4 screw	•	-	-	•	3/4"-24	83357	
956-5307	956-5307-BX	-	10	10	5	1	Acc	Off	Ign/Acc	-	Hencol	3 screw	•	-	-	•	3/4"-24	83357	
956-6307	-	-	10	10	-	-	Acc	Off	Ign/Acc	-	Hencol	3 screw	-	-	-	•	3/4"-24	83357	
956-6310	-	-	30	10	-	-	Acc	Off	Ign/Acc	-	Hencol	3 screw	•	-	-	•	3/4"-24	83357	

Technical Details

Typical Hencol Switch Dimensions

5 Screw Terminals

4 Position

3-position Off-Ign-Ign/Start

3-position Off-Ign/Acc-Ign/Start

(includes anti-restart switches)

4-position diesel ignition

(956-9100)

General Purpose Ignition Switches

95 Series • Metal Body

- Zinc diecast housing
- Coded tumbler locks (2 keys)
- Screw terminals with lock washers
- Fit panels up to 3/8" (9.5mm)
- Key removable at Off positions (except 9518)
- Spring return to IGN or IGN/ACC on all switches.* (except 9578)



Additional information: Littelfuse.com/IgnitionSwitches

PART NUMBERS BULK	PART NUMBERS BOXED	PART NUMBERS RETAIL	AMP RATING (12V DC)				Positions				ACTUATOR / KEY TYPE	TERMINALS	O-RING SEAL	BUSHING SIZE	NOTES	
			ACC	IGN	START	GROUND TOTAL	1	2	3	4						
9579	9579-BX	9579-BP	10	10	5	4	Acc	Off	Ign/Acc	Ign/start	Coded	4 screw	4 blade	-	3/4"-20	-
9579-02	9579-02-BX	-	10	10	5	4	Acc	Off	Ign/Acc	Ign/start	Coded	4 screw	4 screw	-	3/4"-20	Key code CH-505
9513	9513-BX	-	-	10	5	3	Off	Ign	Ign/Start	-	Coded	3 screw	4 blade	-	3/4"-20	-
9578	9578-BX	-	10	10	-	3	Acc	Off	Ign/Acc	-	Coded	3 screw	4 blade	-	3/4"-20	-
95539	95539-BX	-	10	1	5	3	Off	Run	start	-	Coded	4 screw	4 screw	-	3/4"-20	1A Magneto
95582	95582-BX	-	-	10	5	3	Off	Ign	Ign/start	-	Coded	3 screw	4 blade	•	3/4"-20	-
9577	9577-BX	-	10	-	-	2	Off	On (Ign)	-	-	Coded	2 screw	4 screw	-	3/4"-20	-
95535	95535-BX	-	10	5	5	-	Acc	Off	Ign/Acc	Ign/start	Key	4 screw	5 screw	-	13-16"	-
95593	95593-BX	-	10	10	-	-	Rev	Off	Run	-	Key	3 screw	4 screw	-	3/4"	-

* Switch does not have a spring return to IGN or IGN/ACC feature.

95 Series • Metal Body

- Zinc diecast housing
- Military style lever
- Screw terminals with lock washers
- Fit panels up to 11/64" (4.4mm)
- Spring return to IGN or IGN/ACC on all switches



Additional information: Littelfuse.com/IgnitionSwitches

PART NUMBERS BULK	PART NUMBERS BOXED	ACC	IGN	START	TOTAL	Positions				ACTUATOR / KEY TYPE	TERMINALS	O-RING SEAL	BUSHING SIZE	NOTES
						1	2	3	4					
95634-01	95634-01-BX	-	10	5	3	Off	Ign	Ign/Start	-	Mil. Lever	3 screw	•	3/4"-20	-
95633-A	95633-A-BX	10	10	-	2	Off	Ign/Acc	-	-	Mil. Lever	3 screw	-	3/4"-20	Moisture & fungus-resistant per MIL-JAN-T-152

95 Series • Metal Body

- Plated steel housing
- Hencol locks (2 keys)
- Screw terminals with lock washers
- Fit panels up to 1/8" (3.2mm)
- Key removable at Off positions
- Spring return to IGN or IGN/ACC on all switches



Additional information: Littelfuse.com/IgnitionSwitches

PART NUMBERS BULK	PART NUMBERS BOXED	ACC	IGN	START	TOTAL	Positions				ACTUATOR / KEY TYPE	TERMINALS	O-RING SEAL	BUSHING SIZE	NOTES
						1	2	3	4					
95525-A	95525-A-BX	-	10	5	4	Acc	Off	Ign/Acc	Ign/Start	Hencol	4 screw	•	5/8"-32	83357
95524-A	95524-A-BX	-	10	5	3	Off	Ign	Ign/Start	-	Hencol	3 screw	•	5/8"-32	83357
95522-A	-	10	10	-	2	Off	On/Ign	-	-	Hencol	2 screw	•	5/8"-32	83357

General Purpose Ignition Switches



95 Series • Metal Body

- Plated steel housing
- Lever actuator (short or long)
- Fit panels up to 1/8" (3.2mm)
- Spring return to IGN or IGN/ACC on all switches



Additional information: Littelfuse.com/IgnitionSwitches

PART NUMBERS BULK	PART NUMBERS BOXED	AMP RATING (12V DC)		Positions			ACTUATOR / KEY TYPE	TERMINALS	SILVER CONTACTS	O-RING SEAL	BUSHING SIZE	NOTES
		IGN	START	TOTAL	1	2						
95591	95591-BX	10	5	3	Off	Ign/Acc	Ign/Start Lever	4 screw	•	•	5/8"-32	Zinc Diecast Lever
95610	95610-BX	25	20	3	Off	Ign	Ign/Acc Short Lever	3 screw	•	-	5/8"-32	Short Chrome Lever
95612	95612-BX	25	20	3	Off	Ign	Ign/Acc Short Lever	3 screw	•	•	5/8"-32	Short Chrome Lever
-	95613-BX	20	20	3	Off	Ign	Ign/Acc Short Lever	3 Blade	•	•	5/8"-32	Short Chrome Lever

95 Series • Metal Body

- Plated steel housing
- Hencol locks come with 2 keys
- Screw terminals come with lock washers
- Fit panels up to 1/4" (6.4mm)
- Key removable at Off positions
- Spring return to IGN or IGN/ACC on all switches



Additional information: Littelfuse.com/IgnitionSwitches

PART NUMBERS BULK	PART NUMBERS BOXED	AMP RATING (12V DC)		Positions			ACTUATOR / KEY TYPE	TERMINALS	SILVER CONTACTS	O-RING SEAL	BUSHING SIZE	NOTES	REPLACEMENT KEY BLANK
		IGN	START	TOTAL	1	2							
95521-B	95521-B-BX	25	70	3	Off	Ign	Start Long Hencol	3 screw	•	•	5/8"-32	-	83353
95521-01	95521-01-BX	25	70	3	Off	Ign	Start Lever	3 screw	•	•	5/8"-32	Dichromate Lever	80101-A
95033	95033-BX	50	10	3	Glow	Off	Glow/Start Lever	3 screw	-	-	5/8"-32	50A Glow - Diesel	80101-A
95597	95597-BX	50	-	2	Off	On (Ign)	- Long Hencol	2 screw	•	•	5/8"-32	Heavy-Duty	83353
M-288	M-288-BX	50	-	2	Off	On (Ign)	- Lever	2 screw	•	•	5/8"-32	Heavy-Duty	-

5-10A • Compact

- Key removable at Off and On
- 3/4" -24 mounting stem fits panels to 3/4" (19.1mm)
- Compact - Plated steel case, stainless steel bezel and face washer

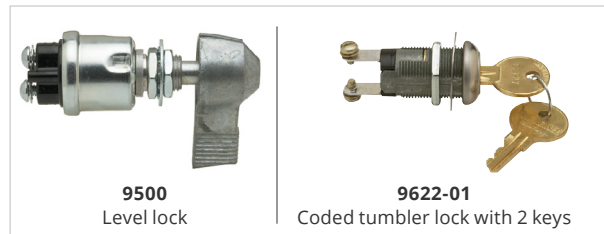

PART NUMBERS BULK	PART NUMBERS BOXED	RATING	Positions		ACTUATOR / KEY TYPE	TERMINALS	MOUNTING STEM
			TOTAL	1 2			
9500	9500-BX	10A at 12V DC	2	Off On (Ign)	Lever	2 screw	1/2"-20 fits panels 13/64" (5.2mm)
9622-01	9622-01-BX	5A at 12V DC	2	Off On (Ign)	Tumbler Key Coded	2 screw	3/4"-24

Marine Grade Ignition Switches

Marine or General Purpose Brass Body Keyed

Marine switches are highly suitable for harsh environments on land or at sea. They are corrosion-resistant, with brass cases. Moisture-repellent insulators, coded locks with 2 brass keys.

- Brass housing and mounting hardware, chrome-plated brass facenut.
- Coded tumbler locks (2 keys)
- Screw terminals with lock washers
- Fit panels up to 1" (25.4mm)
- Key removable at Off positions
- Spring return to IGN or IGN/ACC on all switches



Additional information: Littelfuse.com/IgnitionSwitches

PART NUMBERS BULK	PART NUMBERS BOXED	PART NUMBERS RETAIL	AMP RATING (12V DC)		Positions				ACTUATOR / KEY TYPE	TERMINALS	BUSHING SIZE	NOTES		
			ACC	IGN	START	TOTAL	1	2					3	4
M-6110-05	9579-BX	-	-	10	5	3	Off	Ign	Ign/start	-	Coded Key	3 screw	13/16"-24	Bitted CH-523 Code
M-700	M-700-BX	-	-	5	5	4	Acc	Off	Ign/Acc	Ign/start	Coded Key	4 screw	3/4"-20	Bitted Mixed Codes
M-711	-	-	10	11	12	13	Off	On/Ign	Start	-	Coded Key	3 terminals with 8-32 screw	3/4"-20	CH-502 Code
M-712	M-712-BX	M-712-BP	-	5	5	4	Acc	Off	Ign/Acc	Ign/start	Coded Key	4 screw	13/16"-24	-
M-712-09	M-712-09-BX	M-712-09-BP	10	5	5	4	Acc	Off	Ign/Acc	Ign/start	Coded Key	4 screw	13/16"-24	Rubber Boot
M-550	M-550-BX	M-550-BP	10	10	5	3	Off	Ign	Ign/start	-	Coded Key	3 screw	13/16"-24	-
M-550-14	M-550-14-BX	M-550-14-BP	-	10	5	3	Off	Ign	Ign/start	-	Coded Key	3 screw	13/16"-24	Rubber Boot
M-489	M-489-BX	M-489-BP	-	10	-	2	Off	On/Ign	-	-	Coded Key	2 screw	13/16"-24	-
M-489-03	-	-	-	10	-	2	Off	On/Ign	-	-	Coded Key	2 screw	13/16"-24	Keyhole Shutter

Marine or General Purpose Brass Body Lever

Marine switches are highly suitable for harsh environments on land or at sea. They are corrosion-resistant, with brass cases.

- Brass housing and mounting hardware, chrome-plated diecast long lever.
- Fit panels up to 7/8" (22.2mm)



Additional information: Littelfuse.com/IgnitionSwitches

PART NUMBERS BULK	PART NUMBERS BOXED	AMP RATING (12V DC) IGNITION	POSITION TOTAL	POSITION 1	POSITION 2	ACTUATOR / KEY TYPE	TERMINALS	BUSHING SIZE
M-497	M-497-BX	10	2	Off	On/Ign	Lever	2 screw	1/2"-20

15A Marine Plastic Body

Durable plastic case and stem with PVC boot for added weather protection. Key is removable only in the Off position. Off-Run-Start Spring return to IGN.

- Electrical ratings at 6-36V DC: 15A ignition, 5A start
- Mounting stem fits panels up to 7/8" (22.2mm) thick, with 7/8" diameter hole



Additional information: Littelfuse.com/IgnitionSwitches

PART NUMBERS BULK	PART NUMBERS BOXED	PART NUMBERS RETAIL	POSITION TOTAL	POSITION 1	POSITION 2	POSITION 3	ACTUATOR	TERMINALS	SPRING RETURN	MOUNTING STEM
M-850	M-850-BX	M-850-BP	3	Off	Run	Ign/Start	Key	3 screw	•	Fits panels to 7/8" (22.2mm) with 7/8" Ø hole

Ignition Switch Accessories

Delco Replacement Ignition and Start Switches

Replacement switches sold without a lock cylinder. To receive a new lock cylinder and 2 keys order part number 95874. Both part numbers feature a 1"-24 UNS-2A thread and key is only removable in Off position.

- 7 Blade Terminals accept Delphi (Packard) 6288702. Includes 2 ground terminals for checking indicator bulbs. 1 additional battery terminal provides continuous hotfeed for optional equipment.
- Replaces Delco D-1403-A, D-1406-A, D-1480, D-1498-A, • Chevrolet Trucks 67-83, 85-89, GMC 1116712, 1116683, 1116695, 1116704, 1116709, 1116711, 2234285 • GMC Trucks 67-83, 85-89



Additional information: Littelfuse.com/IgnitionSwitches

PART NUMBERS BULK	POSITION TOTAL	POSITION 1	POSITION 2	POSITION 3	POSITION 4	ACTUATOR	TERMINALS	SPRING RETURN	GROUND TERMINAL	O-RING
95410	4	Acc	Off	Ign/Acc	Ign/Start/Ground	None	7 screw	•	•	•

Ignition Switch Keys, Protective Boots, Caps, Facenuts and Cover Accessories

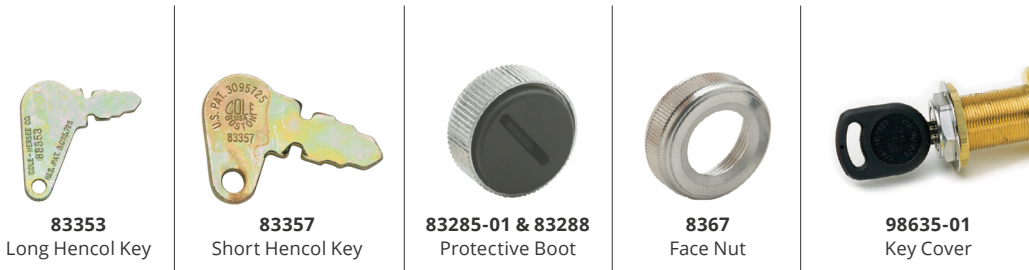

PART NUMBERS BULK	PART NUMBERS BOXED	PART NUMBERS RETAIL	MATERIAL	DESCRIPTION
83353	83353-BX	-	Heavy Gauge Steel Plated	Hencol L Long Key
83357	83357-BX	-	Heavy Gauge Steel Plated	Hencol S Short Key
83274	-	-	Aluminum	Face Nut
83285-01	-	-	Aluminum	Mounting nut containing a rubber self-closing key slot - 3/4"-20 threads 7/16" thick
-	83288-BX	83288-BP	Chrome Brass	Mounting nut containing a rubber self-closing key slot - 13/16"-24 thread 7/32" thick
8367	8367-BX	-	Aluminum	Face Nut Knurled Edges - 3/4"-20 thread 19/64" thick - Clears 5/8" Hole
98635-01	-	-	Plastic	Black Slip-On Cover for Tumbler Keys

Anti-Restart Ignition Switches

What are they, and where should they be used?

The **95060** and **956 Series** Ignition Switches include an Anti-Restart safety feature.

On occasion, vehicle operators do not realize the engine is running and turn on the ignition resulting in a squealing and grinding of gears. If this happens repeatedly, the starter motor will likely burn out. Cole Hersee Anti-Restart Ignition Switches prevent this from happening.



How they work

Most regular Ignition Switches have three positions.

Off: key can be removed. Ignition and accessories (radio, lights etc) are activated when the key is in.

Momentary Start position runs the starter motor. This position is spring-loaded to return to position 2 once the engine is running. If the Ignition Switch is in position 2 and you think it's in position 1, you may be tempted to turn it to position 3 while thinking it is in position 2. This results in the grinding sound. Cole Hersee Anti Restart Ignition Switches prevent the operator from turning to Position 3 when the engine is running. This safeguard against burnt-out motors can be retrofitted into any kind of vehicle, such as forklifts or mining vehicles where the ambient noise is high. This kind of 'lockout ignition' is available with a standard ignition key or with a lever for off-road applications.



Additional information: Littelfuse.com/IgnitionSwitches



95060



956-3122



95061



956-3124



95062

Technical Details

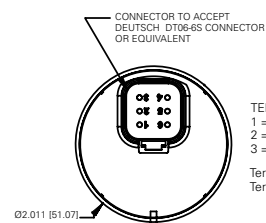
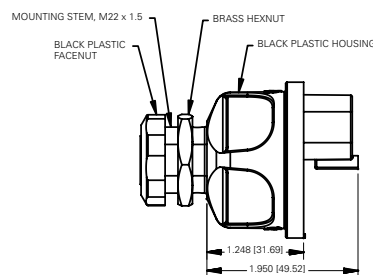
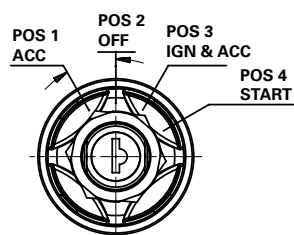

TERMINALS
 1 = Battery 4 = Ignition
 2 = Start 5 = Ignition
 3 = Accessory 6 = Battery

Terminals 1 and 6 are connected internally.
 Terminals 4 and 5 are connected internally.

Rocker Switches



What is Dependent and Independent Illumination?

Dependent:

The actuator is illuminated only when the switch is turned on.

Independent:

Illumination is not affected by the actuation of the switch. The illumination can be switched on or off by another switch, such as headlight or interior lighting controls. This is especially useful when locating switches in the dark.

What Does SPST or DPST Mean?

The first two letters, SP or DP, refer to single pole or double pole. The second two letters, ST or DT refer to single throw or double throw.

Pole refers to the number of circuits controlled by the switch. SP switches control one circuit and DP switches control two independent circuits (which act like two identical switches that are mechanically linked). Pole is often confused with terminal, which is a common mistake. Terminals are used for wire connections on the back of the unit and are specified separately.

Throw refers to the extreme position of the actuator. ST switches close a circuit at only one position and the other position is off. DT switches close a circuit in the Up position, as well as the down position and can be configured with two positions (On-On) or three positions (On-Off-On).

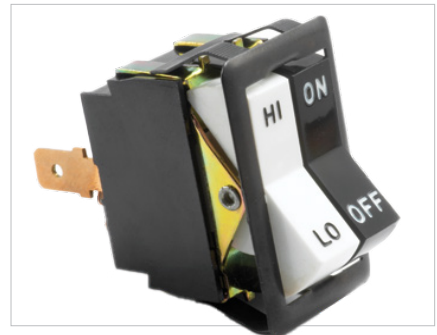

Sealed Rocker Switches

LED • 25A

- Weather-resistant with contact areas sealed to IP66 (high pressure wash resistant).
- Super-bright LED illumination and high-visibility wrap-around lenses.
- LEDs give visibility, even in sunlight and have a long life.
- Silver contacts and corrosion-resistant nickel-plated brass blades for superior performance and electrical contact.

Additional information: Littelfuse.com/RockerSwitches



58312-A2 & A4



58312-R2 & R4



58312-C4



58312-G4



58312-AG

PART NUMBERS BULK	PART NUMBERS BOXED	RATING	POLE & THROW	ACTION	ILLUMINATION	LED PILOT LIGHT LENS COLOR 1	LED PILOT LIGHT LENS COLOR 2	TERMINALS	CONTACTS	SEALING
58312-R2	-	25A at 12V DC	SPST	On-Off	Independent	Red	-	4 blade	Silver	IP66
58312-A4	58312-A4-BX	25A at 12V DC	SPST	On-Off	Dependent	Amber	-	3 blade	Silver	IP66
58312-B1	-	25A at 12V DC	SPST	On-Off	Dependent	Blue	-	3 blade	Silver	IP66
58312-C4	-	25A at 12V DC	SPST	On-Off	Dependent	Clear	-	3 blade	Silver	IP66
58312-G4	58312-G4-BX	25A at 12V DC	SPST	On-Off	Dependent	Green	-	3 blade	Silver	IP66
58312-R4	58312-R4-BX	25A at 12V DC	SPST	On-Off	Dependent	Red	-	3 blade	Silver	IP66
58312-AG	58312-AG-BX	25A at 12V DC	SPST	On-Off-On	Dependent	Amber	Green	4 blade	Silver	IP66

Note: 24V DC versions can be made available for volume exceeding 1000 pieces. Please contact Littelfuse for more details.

Standard Mounting Hole

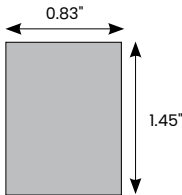

Forward-Reverse Switch

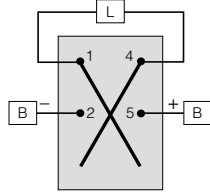

Non-Illuminated • 25A and 15A

- Weather-resistant with contact areas sealed to IP66 (high pressure wash resistant)
- Silver contacts and corrosion-resistant nickel-plated brass blades for superior performance and electrical contact

Additional information: Littelfuse.com/RockerSwitches



PART NUMBERS BULK	PART NUMBERS BOXED	PART NUMBERS RETAIL CLAMSHELL	RATING	POLE & THROW	ACTION	TERMINALS	CONTACTS	SEALING	NOTES
58311-01	-	-	25A at 12V DC 15A at 24V DC	SPST	On-Off	2 blade	Silver	IP66	-
58311-02	-	58311-02-BP		SPST	Mom On-Off	2 blade	Silver	IP66	-
58311-07	-	-		DPST	On-Off-On	6 blade	Silver	IP66	-
58311-08	-	-		DPST	On-On	6 blade	Silver	IP66	-
58311-11	-	58311-11-BP		DPST	On-Off-On	4 blade	Silver	IP66	Forward & Reverse
58311-13	58312-AG-BX	-		DPST	Off-On-Mom On	4 blade	Silver	IP66	Ignition & Start
58311-18	-	58311-18-BP		DPST	Mom On-Off-Mom On	4 blade	Silver	IP66	Forward & Reverse
58336	-	-		SPST	On-Off (Lockable)	2 blade	Silver	IP66	Black Rocker and Orange Lock
58337	-	-		DPST	Open-Off-Close	2 blade	Silver	IP66	Black Rocker with White Text "Open - TARP - Close"

Sealed Rocker Switches

58328 Series • 25A Incandescent Pilot Light

- Series available with small pilot lights, large pilot lights or unlit
- Dependent or independent illumination
- Faceted lenses are on the actuator
- Matte black finish on the plastic housing, bezel and actuator
- Brass blade or screw terminals available
- See accessories section for bezels and mounting kits



Additional information: Littelfuse.com/RockerSwitches

PART NUMBERS BULK	PART NUMBERS BOXED	PART NUMBERS RETAIL CLAMSHELL	RATING	POLE & THROW	ACTION	ILLUMINATION	LED PILOT LIGHT LENS COLOR 1	LED PILOT LIGHT LENS COLOR 2	TERMINALS	CONTACTS	SEALING
58328-02	-	-	25A at 12V DC	SPST	On-Off	Independent	Green	-	4 blade	Silver	IP66
-	-	58328-101-BP		SPST	On-Off	Independent	One lens of each color	-	4 blade	Silver	IP66
58328-04	58328-04-BX	-		SPST	On-Off	Dependent	Red	-	3 blade	Silver	IP66
58328-11	58328-11-BX	-		SPST	On-Off	Dependent	Green	-	3 blade	Silver	IP66
-	58328-12-BX	-		SPST	On-Off	Dependent	Clear	-	3 blade	Silver	IP66
58328-13	58328-13-BX	-		SPST	On-Off	Dependent	Amber	-	3 blade	Silver	IP66
58328-55	-	-		SPST	On-Off	Dependent	Blue	-	3 blade	Silver	IP66
58328-58	-	-		SPST	On-Off	Dependent	Red	-	3 blade	Silver	IP66
58328-62	-	-		SPST	On-Off	Dependent	Amber	-	3 blade	Silver	IP66
-	-	58328-100-BP		SPST	On-Off	Dependent	One lens of each color	-	3 blade	Silver	IP66
58328-35	58328-35-BX	-		SPDT	On-Off-On	Dependent	Red	Amber	4 blade	Silver	IP66
-	-	58328-103-BP		SPDT	On-Off-On	Dependent	One lens of each color	-	4 blade	Silver	IP66

58332 Series • 20A

58332 switches are supplied in retail BP only and are supplied with one black and one gray snap-on actuator. These general-purpose switches are suitable for all kinds of applications.

- They are weather-resistant with contact areas sealed to IP66 (high pressure wash-resistant).
- Recognized at UL 1500 (Ignition protection for marine products). With neoprene gasket/panel seal.
- Conveniently snap into a standard rectangular mounting hole 1.48" x 0.83" (36.8 x 21.1mm) in panels from 0.09" to 0.19" thick (2.4 x 4.7mm).
- Plastic housing, bezel and actuator.
- Silver contacts, Brass blade terminals.



Additional information: Littelfuse.com/RockerSwitches

PART NUMBERS BULK	RATING	POLE & THROW	ACTION	ILLUMINATION	LED PILOT LIGHT LENS COLOR 1	LED PILOT LIGHT LENS COLOR 2	TERMINALS	CONTACTS	SEALING
58332-04-BP	25A at 12V DC	SPST	On-Off	Independent	Green	Red	4 blade	Silver	UL1500 IP66
58332-20-BP		SPST	Mom On-Off		-	-	2 blade		
58332-21-BP		SPST	On-Off-On		Amber	Amber	4 blade		
58332-22-BP		SPST	Mom On-Off-Mom On		-	-	3 blade		
58332-23-BP		SPST	On-Off-Mom On		Amber	-	3 blade		
58332-25-BP		DPST	On-Off-Mom On		Amber	-	7 blade		
58332-26-BP		DPST	On-Off-On		Amber	Amber	7 blade		
58332-27-BP		DPST	Mom On-Off-Mom On		-	-	6 blade		
58332-28-BP		DPST	Mom On-Off		-	-	5 blade		
58332-29-BP		DPST	On-Off		Amber	-	5 blade		
58332-30-BP		SPST	On-Off-On		Amber	Amber	4 blade		
58332-31-BP		SPST	On-Off-Mom On		Amber	-	4 blade		
58332-32-BP		DPST	On-Off-Mom On		Amber	-	7 blade		
58332-33-BP		DPST	On-Off-On		Amber	Amber	7 blade		
58332-34-BP		DPST	On-Off		Amber	-	5 blade		

Sealed Rocker Switches

56327 & 58327 Series • 25A Small Round Lens Pilot Light

- Series available with small pilot lights, large pilot lights or unlit
- Dependent or independent illumination
- Faceted lenses are on the actuator
- Matte black finish on the plastic housing, bezel and actuator
- Brass blade or screw terminals available
- See accessories section for bezels and mounting kits

Additional information: Littelfuse.com/RockerSwitches



PART NUMBERS BULK	PART NUMBERS BOXED	PART NUMBERS RETAIL CLAMSHELL	RATING	POLE & THROW	ACTION	ILLUMINATION	LED PILOT LIGHT LENS COLOR 1	LED PILOT LIGHT LENS COLOR 2	TERMINALS	CONTACTS	SEALING
56327-01	56327-01-BX	56327-01-BP	25A at 12V DC	SPST	On-Off	Dependent	Red	-	3 screw	Silver	IP66
58327-01	58327-01-BX	58327-01-BP		SPST	On-Off	Dependent	Red	-	3 blade	Silver	IP66
58327-06	58327-06-BX	58327-06-BP		SPST	On-Off-On	Dependent	Red	Red	4 blade	Silver	IP66

56027 & 58027 Series • 25A Non-Illuminated Rocker Switches

- Series available with small pilot lights, large pilot lights or unlit
- Matte black finish on the plastic housing, bezel and actuator
- Brass blade or screw terminals available
- See accessories section for bezels and mounting kits

Additional information: Littelfuse.com/RockerSwitches



PART NUMBERS BULK	PART NUMBERS BOXED	PART NUMBERS RETAIL CLAMSHELL	RATING	POLE & THROW	ACTION	TERMINALS	CONTACTS	SEALING	NOTES
56027-01	56027-01-BX	56027-01-BP	25A at 12V DC	SPST	On-Off	2 screw	Silver	IP66	-
58027-01	58027-01-BX	-		SPST	On-Off	2 blade	Silver	IP66	-
58027-02	58027-02-BX	58027-02-BP		SPST	Mom On-Off	2 blade	Silver	IP66	-
58027-03	58027-03-BX	58027-03-BP		SPST	On-Off-On	3 blade	Silver	IP66	-
58027-04	58027-04-BX	58027-04-BP		SPST	Mom On-Off-Mom On	3 blade	Silver	IP66	-
58027-06	58027-06-BX	-		DPST	On-Off	4 blade	Silver	IP66	-
58027-07	58027-07-BX	58027-07-BP		DPDT	On-Off-On	6 blade	Silver	IP66	-
58027-08	-	-		DPDT	On-On	6 blade	Silver	IP66	-
58027-11	58027-11-BX	58027-11-BP		DPDT	Mom On-Off-Mom On	6 blade	Silver	IP66	-
58027-18	58027-18-BX	-		DPDT	Mom On-Off-Mom On	4 blade	Silver	IP66	Forward & Reverse

Forward-Reverse Switch

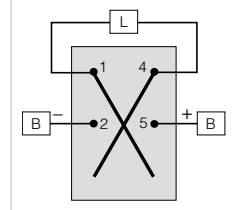

25A Wide Body Dual Rocker Switches

- Two Single Pole switches in one body
- Universal application switches
- Snap-in mounting
- Silver contacts, copper blade terminals
- Black or white actuators, imprinted in contrasting black or white
- Snaps into panel hole 1.0"x1.125" (25.4x28.6mm) and fits panels .030" thru .250" thick (.76 - 6.35mm)

Additional information: Littelfuse.com/RockerSwitches



PART NUMBERS BULK	Left Switch				Right Switch			TERMINALS	BEZEL WIDTH
	RATING	ACTION	ACTUATOR	PRINT	ACTION	ACTUATOR	PRINT		
54204-01	10A at 12V DC	On1-Off-On2	Black Rocker	Hi, Lo	On1-Off-On2	Black Rocker	Hi, Lo	6 Blade	Wide

Sealed Rocker Switches

M-58031 Series • 20A

- Certified to IP66 for protection against dust and prolonged spray
- Recognized at UL 1500: Ignition Protection for Marine Products
- Neoprene gasket/panel seal with black nylon bezel and black plastic housing
- 20A at 12V DC. Blade terminals, silver contacts

Additional information: Littelfuse.com/RockerSwitches



PART NUMBERS BULK	PART NUMBERS BOXED	PART NUMBERS RETAIL CLAMSHELL	RATING	POLE & THROW	ACTION	TERMINALS	CONTACTS	SEALING
M-58031-01	M-58031-01-BX	M-58031-01-BP	20A at 12V DC	SPST	On-Off	2 Blade	Silver	IP66
M-58031-02	-	M-58031-02-BP		SPDT	On-Off-On	3 Blade	Silver	IP66
M-58031-04	-	M-58031-04-BP		DPST	On-Off	4 Blade	Silver	IP66
M-58031-07	-	M-58031-07-BP		SPST	Mom On-Off	2 Blade	Silver	IP66
M-58031-08	-	-		SPDT	Mom On-Off-Mom On	3 Blade	Silver	IP66
M-58031-09	M-58031-09-BX	-		DPDT	Mom On-Off-Mom On	6 Blade	Silver	IP66

M-58031 Series • 20A

Single or dual pilot lights. Faceted lenses inset into the actuator. Matte black plastic housing, bezel and actuator. Silver contacts. Internal seal.

- Certified to IP66 for protection against dust and prolonged spray
- Neoprene gasket/panel seal with black nylon bezel and black plastic housing
- 20A at 12V DC. Blade terminals, silver contacts
- Other imprints available upon request. Contact Littelfuse for details

Additional information: Littelfuse.com/RockerSwitches



58326-01



58326-06



58326-11

PART NUMBERS BULK	PART NUMBERS BOXED	RATING	POLE & THROW	ACTION	ILLUMINATION	LED PILOT LIGHT	IMPRINT ACTUATOR	IMPRINT LENS SYMBOL	TERMINALS	CONTACTS	SEALING
-	58326-01-BX	20A at 12V DC	SPST	Off-On	Independent	Red	None	None	4 Blade	Silver	IP66
58326-06	-		SPDT	On-Off-Mom On	Independent	Red	Override - LVD Auto Mode - System Off	Battery	5 Blade	Silver	IP66
58326-11	58326-11-BX		DPST	Off-On-Mom On	Independent	White	Amber - Warning (On) - Off	SAE lamp symbol	6 Blade	Silver	IP66
58326-15	-		SPST	On-Off	Independent	White	On-Interior-Off	Dome Light	4 Blade	Silver	IP66
58326-27	58326-27-BX		DPDT	On-On-On	Independent	White	Lo/Hi-Pass Heater-Off	Fan	8 Blade	Silver	IP66
58326-29	58326-29-BX		DPDT	On-On-On	Independent	White	Lo/Hi-Fan-Off	Fan	8 Blade	Silver	IP66

Rocker Switches and Accessories

Narrow Curved Body • 10A

- Curved matte finish narrow body rocker switches
- Fits panels .025" through .200" (.64 to 5.2mm)
- Universal application switches
- Snap-in mounting

Additional information: Littelfuse.com/RockerSwitches



PART NUMBERS BULK	PART NUMBERS BOXED	PART NUMBERS RETAIL CLAMSHELL	RATING	POLE & THROW	ACTION	TERMINALS	ACTUATOR COLOR	ACTUATOR ILLUMINATION
54003	54003-BX	-	10A at 12V DC	SPST	On-Off	3 Blade	Red	-
54007	-	54007-BP		SPDT	On-On	3 Blade	Black Face - Red Edges	-
54010	54010-BX	-		SPDT	On-On	3 Blade	Black	-

Rocker Switch Bezel and Mounting Accessories

Snap-in mounting of any regular size switch such as 56027, 58030, 58332, 58311, 58312 or 58328 series.

- Bezels can be arranged in a parallel array of any length. Bezels themselves can snap into a panel, or be mounted with the bracket mounting kit.
- Mounting hole in panel should be 2.02"W x 1.90"H (51.3 x 48.3mm) for two bezels. Add 1.03"W (26.2mm) for each additional unit.

Additional information: Littelfuse.com/RockerSwitches



PART NUMBERS BULK	PART NUMBERS BOXED	PART NUMBERS RETAIL CLAMSHELL	DETAILS	NOTES	DIMENSIONS
82159-1	82159-1-BX	82159-1-BP	End Bezel	Can be used as left or right end	Two units are 2.37"W x 2.30"H (60.2 x 58.4mm)
82159-2	82159-2-BX	-	Center Bezel	Can be ganged and used with end bezels	Two units are 2.37"W x 2.30"H (60.2 x 58.4mm)
82159-3	82159-3-BX	-	Independent Bezel	Fits Panel Openings: 1.90" x 0.984" (48.3 x 25.0mm)	-
98628	98628-BX	-	Bezel Panel Plug	Fits Panel Hole: .83" x 1.45" (21.1 x 36.8mm)	Face Dimensions: 1.91" x 0.96" (24.4 x 48.8mm)
-	-	82159-02-BP	2 End Bezels, 1 Center Bezel, 1 Plug	Bezel Retail Kit	-
-	-	87167-01-BP	2 Brackets, 1 Brass Stabilizing Rod	Bracket Mounting Retail Kit (holds 2 to 6 bezels)	Assembled kit mounts on top of or under the panel. Mounting holes .710"x.235" (18.0x6.7mm)

Standard Heavy Duty Rocker Switches

25A • with and without Pilot Lights

- Narrow or wide, moisture-resistant plastic, nickel plate or black housings, bezels and actuators
- Snap-in mounting to fit panels
- Brass blade or screw terminals

Additional information: Littelfuse.com/RockerSwitches

Metal Body Part Numbers



PART NUMBERS BULK	PART NUMBERS BOXED	RATING	POLE & THROW	ACTION	TERMINALS	WIDTH	COLOR	ACTUATOR	PILOT LIGHT	CONTACTS
56000-01	-	25A at 12V DC	SPST	On-Off	2 Screw	Narrow	Nickel Plated	White	-	Silver
56000-04	56000-04-BX		SPST	On-Off	2 Screw	Narrow	Nickel Plated	Black	-	Silver
56300-01	56300-01-BX		SPST	On-Off	3 Screw	Narrow	Nickel Plated	White	•	Silver
57000-01	57000-01-BX		SPST	On-Off	2 Blade	Narrow	Nickel Plated	White	-	Silver
57000-04	-		SPST	On-Off	2 Blade	Narrow	Black	Black	-	Silver
57000-10	-		SPST	On-Off	2 Blade	Narrow	Black	Black	-	Silver
57003-01	57003-01-BX		SPDT	On-Off-On	3 Blade	Narrow	Nickel Plated	White	-	Silver
57004-10	57004-10-BX		SPDT	Mom-Off-Mom	3 Blade	Narrow	Black	White	-	Silver
57006-01	-		DPDT	On-Off-On	6 Blade	Narrow	Nickel Plated	White	-	Silver
57006-07	57006-07-BX		DPDT	On-Off-On	6 Blade	Narrow	Black	White	-	Silver
57007-11	-		SPDT	On-On-Off	3 Blade	Narrow	Black	Black	-	Silver
57014-03	57014-03-BX		DPDT	Mom-Off-Mom	4 Blade	Narrow	Black	White	-	Silver
57300-01	57300-01-BX		SPST	On-Off	3 Blade	Narrow	Nickel Plated	White	•	Silver
57300-22	57300-22-BX		SPST	On-Off	3 Blade	Narrow	Black	White	-	Silver
57300-11	57300-11-BX		SPST	On-Off-On	4 Blade	Narrow	Black	White	•	Silver
57300-03	57300-03-BX		SPST	On-Off	3 Blade	Narrow	Nickel Plated	Black	•	Silver
57300-02	-		SPST	On-Off	3 Blade	Wide	Nickel Plated	White	•	Silver

Plastic Body Part Numbers

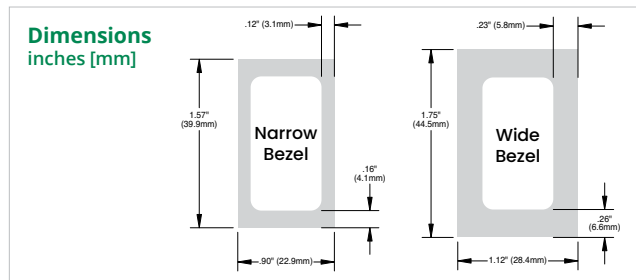
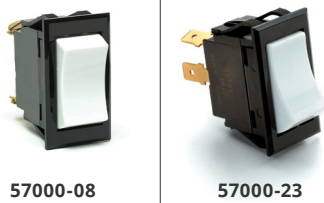

PART NUMBERS BULK	PART NUMBERS BOXED	RATING	POLE & THROW	ACTION	TERMINALS	ACTUATOR	CONTACTS
56000-08	-	25A at 12V DC	SPST	On-Off	2 Screw	White	Silver
57000-23	57000-23-BX	25A at 12V DC	SPST	On-Off	2 Blade	White	Silver
57013-08	57013-08-BX	25A at 12V DC	DPDT	Mom On-Off-Mom On	6 Blade	White	Silver

FAQ's Rocker and Toggle Switches

Can I replace the bulb in any of your Rocker or Toggle Switches?

The bulbs are wired inside the Switch and therefore cannot be replaced. We use a long lasting bulb so the need for bulb replacement is unlikely in a normal automotive application. We also have LED switches such as 58312 Series that never need replacement.

Can I use your Non-Lighted Toggle or Rocker Switches in 110V AC applications?

Except for Switches M-493 and similar Switches, none of our Switches are officially rated for AC voltage application. While we are confident some of them can, it is entirely up to the end user to determine their suitability for such application.

Can I use your Lighted Rocker and Toggle Switches at 110V AC?

No. The lamps inside the Switches have specific voltage ratings.

Can I use your Lighted Rocker and Toggle Switches at 24V DC?

You need to select only the ones rated for 24V because the lights function only at the designed voltage.

Can I use your Rocker and Non-Lighted Toggle switches at 24V DC?

Yes. If they are rated at 12V, you must reduce the current rating by half to obtain the same durability.

Can I get any Rocker or Toggle Switches modified to meet my special application?

Yes, in most cases. It is possible we make a suitable item already that isn't listed because of its specialized use. Alternatively, we can make it for you. We have a minimum quantity requirement for special orders.

Do your Rocker or Lighted Toggle Switches have incandescent or LED lamps?

We have both. Contact us if you need a special order with LEDs.



M-58031-01



54007



58312-A2 & A4



58312-R2 & R4



5558

Toggle Switches

Littelfuse toggle switches are designed to meet diverse electrical control needs. Our series of toggle switches offer reliable performance across a range of applications with current ratings of 10-25A. Choose from various circuitry options including DPDT, DPST, SPDT, and SPST to suit your specific requirements.

Engineered for Low to High Duty Applications

These toggle switches are designed for low to high duty applications, ensuring consistent and efficient operation in various scenarios. The switches are sealed and dust-proof, enhancing their durability and reliability even in challenging environments.

Standard and Lighted Options

Our portfolio includes both standard and lighted options, providing flexibility to cater to different user preferences and operational needs. The lighted options offer enhanced visibility in low-light conditions, contributing to improved user experience.

Customization

Customization is at your fingertips with our toggle switches, as they come with toggle handle length and style options. Tailor the switches to your liking, ensuring a seamless integration into your control systems.

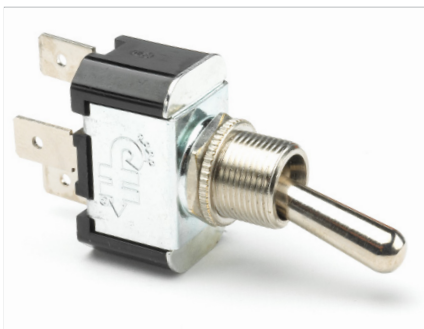

Toggle Switches

55025 Series • 25A

- Waterproof and dustproof to IP68 standard – allows mounting in demanding or harsh locations
- Bushing, handle and hardware – nickel-plated brass
- Standard handle, 0.60" long (15.3mm)
- Standard mounting panel hole 0.468 – 0.474" diameter (11.9-12.0mm)
- Standard bushing diameter 0.47 (12.0mm) 15/32" thread, 0.32" long (5.8mm)
- Wires: 14AWG (2mm²), 12" long (304.8mm)
- Switch body: 1.24" deep x 0.87" wide x 1.46" high (31.6 x 22.0 x 37.1mm)



Additional information: Littelfuse.com/55025

PART NUMBERS BULK	PART NUMBERS BOXED	PART NUMBERS RETAIL CLAMSHELL	RATING	POLE & THROW	ACTUATOR	ACTION	TERMINALS	CONTACTS	SEALING
55025	55025-BX	55025-BP	25A at 12V DC 15A at 24V DC	SPST	Nickel-plated brass handle	On-Off	2 wire	Silver	IP68
55025-01	55025-01-BX	55025-01-BP		SPST		Mom On-Off	2 wire		IP68
55025-02	55025-02-BX	55025-02-BP		SPDT		On-Off-On	3 wire		IP68
55025-03	55025-03-BX	55025-03-BP		SPDT		On-On	3 wire		IP68
55025-04	55025-04-BX	55025-04-BP		SPDT		Mom On-Off-Mom On	3 wire		IP68

54100 Series • Standard or Illuminated • 25A

Available in a standard black nylon handle or a lighted clear plastic handle, that is 11/16" (17.5mm) long.

- Mounting stem 15/32"-32 thread, 15/32" (11.9mm) long, fits panels up to 1/8" (31.8mm) thick
- Includes mounting hardware: black metal facenut and nickel-plated hexnut
- Terminals: .250" blade or 6-32 screw

Additional information: Littelfuse.com/54100

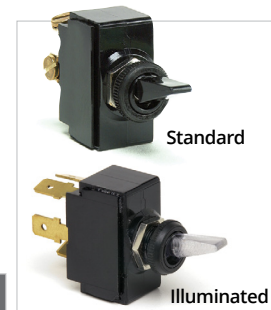

Illumination Color

PART NUMBERS BULK	PART NUMBERS BOXED	PART NUMBERS RETAIL CLAMSHELL	RATING	POLE & THROW	ACTUATOR	ACTION	ILLUMINATION	DOWN	CENTER	UP	TERMINALS	CONTACTS	SEALING
54101-01	-	-	25A at 12V DC	SPST	Black Plastic Paddle	Mom On-Off	-	-	-	-	2 blade	-	-
54109	54109-BX	54109-BP		SPST	Clear Plastic Paddle	On-Off	Independent or Dependent	White	-	Red	4 screw	-	O-ring in bushing
54109-01	54109-01-BX	-		SPST	Black Plastic Paddle	On-Off	Independent or Dependent	White	-	Red	4 blade	-	O-ring in bushing
54103	-	54103-BP		SPDT	Black Plastic Paddle	On-Off-On	-	-	-	-	3 screw	Silver	-
54104	54104-BX	54104-BP		SPDT	Black Plastic Paddle	Mom On-Off-Mom On	-	-	-	-	3 screw	-	-
54110	-	-		SPDT	Clear Plastic Paddle	On-Off-On	Independent or Dependent	White	White	Red	4 screw	-	O-ring in bushing
54107-01	-	54107-01-BP		DPDT	Black Plastic Paddle	On-Off-On	-	-	-	-	6 screw	-	-

Wiring Diagrams

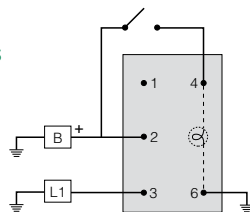

54109 independent wiring

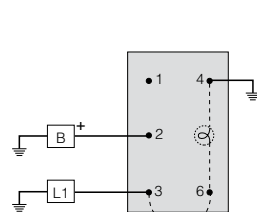

54109 dependent wiring

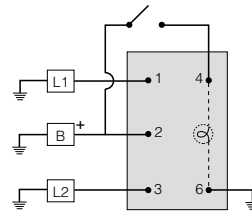

54110 independent wiring

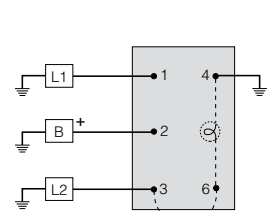

54110 dependent wiring

Toggle Switches

Heavy Duty • 25A

Replacement switches sold without a lock cylinder. To receive a new lock cylinder and 2 keys order part number 95874. Both part numbers feature a 1"-24 UNS-2A thread and key is only removable in Off position.

Additional information: Littelfuse.com/ToggleSwitches

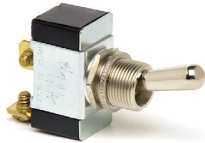

Standard Handle
11/16" (17.5mm) long

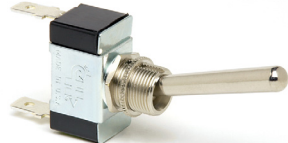

Long Handle
1 1/2" (38.1mm) long



PVC Coated Housing
with wire leads

PART NUMBERS BULK	PART NUMBERS BOXED	PART NUMBERS RETAIL CLAMSHELL	RATING	POLE & THROW	ACTUATOR LENGTH	MATERIAL	ACTION	TERMINALS	CONTACTS	PVC COATED	O-RING SEAL
5520	5520-BX	5520-BP	25A at 12V DC, 15A at 24V DC	SPST	Standard	Nickel-Plated Brass	On-Off	2 screw		-	•
5582	5582-BX	5582-BP		SPST	Standard		On-Off	2 screw		-	-
-	-	5582-30-BP		SPST	Standard		On-Off	2 wire		-	-
5582-36	-	-		SPST	Standard		On-Off	Aptiv 12010973		-	-
5582-10	5582-10-BX	5582-10-BP		SPST	Standard		On-Off	2 wire		-	•
55014	55014-BX	55014-BP		SPST	Standard		On-Off	2 blade		-	-
55014-05	55014-05-BX	-		SPST	Standard		On-Off	2 blade		-	•
55016-06	-	55016-06-BP		SPDT	Standard		On-Off-On	3 blade		-	-
55055	55055-BX	55055-BP		SPST	Long		On-Off	2 blade		-	-
55055-01	55055-01-BX	-		SPST	Long		On-Off	2 screw		-	-
55020	55020-BX	55020-BP		SPST	Standard		Off-Mom On	2 screw		-	-
55020-02	-	55020-20-BP		SPST	Standard		Off-Mom On	2 blade		-	-
55020-04	55020-04-BX	55020-04-BP		SPST	Standard		Off-Mom On	2 wire		•	•
5584	5584-BX	-		SPDT	Standard		On-On	3 screw		-	-
5584-15	-	-		SPDT	Standard		On-On	3 wire		-	-
5586	5586-BX	5586-BP		SPDT	Standard		On-Off-On	3 screw		-	-
55015	55015-BX	-		SPDT	Standard		On-On	3 blade		-	-
55016	55016-BX	-		SPDT	Standard		On-Off-On	3 blade		-	-
55036	55036-BX	-		SPDT	Standard		On-Off-On	3 wire		•	•
55021	55021-BX	55021-BP		SPDT	Standard		Mom On-Off-Mom On	3 screw		-	-
55021-04	55021-04-BX	55021-04-BP		SPDT	Standard		Mom On-Off-Mom On	3 blade		-	-
55021-07	55021-07-BX	55021-07-BP		SPDT	Standard		Mom On-Off-Mom On	3 wire	Silver	•	•
55033-01	55033-01-BX	-		SPDT	Standard		Mom On-Off-Mom On	3 blade		-	-
55033-02	55033-02-BX	-		SPDT	Long		Mom On-Off-Mom On	3 blade		-	-
55036-14	-	55036-14-BP		SPDT	Standard		On-Off-On	3 wire		•	-
55037	55037-BX	-		SPST	Standard		Mom On	2 blade		-	-
55057	55057-BX	-		DPST	Long		On-Off-On	4 blade		-	•
55081	55081-BX	55081-BP		DPDT	Standard		Mom On-Off-On	6 blade		-	•
55088	55088-BX	55088-BP		SPDT	Standard		On-Off-Mom On	3 screw		-	-
5588	5588-BX	5588-BP		DPST	Standard		On-Off	4 screw		-	-
55017	55017-BX	-		DPST	Standard		On-Off	4 blade		-	-
55017-02	55017-02-BX	-		DPST	Long		On-Off	4 blade		-	-
5590	5590-BX	-		DPDT	Standard		On-On	6 screw		-	-
5592	5592-BX	5592-BP		DPDT	Standard		On-Off-On	6 screw		-	-
55018	55018-BX	-		DPDT	Standard		On-On	6 blade		-	-
55019	55019-BX	55019-BP		DPDT	Standard		On-Off-On	6 blade		-	-
55054	55054-BX	55054-BP		DPDT	Standard		Mom On-Off-Mom On	6 screw		-	-
55054-04	55054-04-BX	-		DPDT	Long		Mom On-Off-Mom On	6 screw		-	-
55065-02	55065-02-BX	-		DPDT	Long		Mom On-Off-Mom On	6 blade		-	-
55065-03	55065-03-BX	-		DPDT	Standard		Mom On-Off-Mom On	6 blade		-	-
55046	55046-BX	-	DPDT	Standard	Mom On-Off-Mom On	4 blade		-	-		
55046-04	55046-04-BX	-	DPDT	Long	Mom On-Off-Mom On	4 blade		-	-		
55049-01	55049-01-BX	-	SPST	Long	On-Mon-Off	2 blade		-	-		
-	55107-01-BX	-	SPDT	Standard	On-On	9 blade		-	-		

Toggle Switches

Light Duty • 10A

- Standard handle: 11/16" (17.46mm) long • Ball handle: 3/8" (9.52mm) long
- Mounting stem has 15/32"-32 thread, 15/32" (11.9mm) long, and fits panels up to 9/32" (7.2mm) thick

Additional information: Littelfuse.com/ToggleSwitches



PART NUMBERS BULK	PART NUMBERS BOXED	PART NUMBERS RETAIL	RATING	POLE & THROW	ACTUATOR TYPE	ACTUATOR MATERIAL	ACTION	TERMINALS	CONTACTS
5558	5558-BX	5558-BP	10A at 12V DC	SPST	Standard	Nickel-Plated Brass	Off-On	2 screw	Silver
5570	5570-BX	-	10A at 12V DC	SPST	Standard	Nickel-Plated Brass	Off-On	2x 6" wire leads	Silver
55013	55013-BX	-	10A at 12V DC	SPST	Standard	Nickel-Plated Brass	Off-On	2 blade	Silver
M-484	M-484-BX	M-484-BP	10A at 12V DC	SPST	Standard	Chrome-Plated Brass	Off-On	2 screw	Silver
M-493	-	M-493-BP	10A at 12V DC	SPST	Ball	Chrome-Plated Brass	Off-On	2 screw	Silver
M-584	M-584-BX	M-584-BP	10A at 12V DC	SPST	Standard	Chrome-Plated Brass	Off-On	2x 6" wire leads	Silver

551800 Series • Extra Heavy Duty • 30A

Universal application. Diecast housing. For stem- or bracket-mounting. 15/32"-32 thread mounting stem, with keyway.

- Brackets: .170" (4.3mm) diameter holes, 1.72" (43.7mm) on centers
- Fits panels up to 3/16" (4.8mm) thick
- Chrome plated brass handle, 1 1/16" long (27.0mm)

Additional information: Littelfuse.com/ToggleSwitches

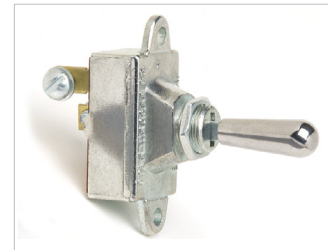

PART NUMBERS BULK	PART NUMBERS BOXED	PART NUMBERS RETAIL	RATING	POLE & THROW	ACTION	ACTUATOR	TERMINALS	CONTACTS
-	551001-BX	-	20A at 6-12V DC	SPST	Mom On-Off	Chrome-plated brass handle	2 blade	Silver
-	551800-BX	-		SPST	On-Off		2 screw	
-	551846-BX	-	30A at 6-12V DC	DPDT	On-Off-On		6 screw	
551849	-	-	15A at 24-36V DC	SP3C	On-On-Off		4 screw	

M-54111 Series • Lighted Tip Toggles • 25A

Tip of handle is illuminated Red in the On position, illuminated Clear in the Off position.

Additional information: Littelfuse.com/ToggleSwitches



Illumination Color

PART NUMBERS BULK	PART NUMBERS BOXED	PART NUMBERS RETAIL CLAMSHELL	RATING	POLE & THROW	ACTION	ACTUATOR	ILLUMINATION	ON	OFF	TERMINALS	CONTACTS
M-54111-01	M-54111-01-BX	M-54111-01-BP	25A at 12V DC	SPST	On-Off	Black plastic handle with illuminated tip	Independent or Dependent	Red	White	4 blade	Silver
M-54111-02	M-54111-02-BX	M-54111-02-BP		SPDT	On-Off-On			5 blade			

Wiring Diagrams

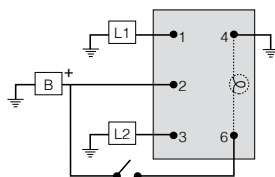
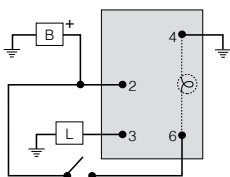

Toggle Switches

59024 Series • Long Handle “Duck Bill” • 25A

- 15/32"-32 thread mounting stem
- Fits panels up to 1/4" (6.4mm) thick
- Includes mounting hardware: black knurled facenut, hexnut
- Keyway is in the down position. 1" (25.4mm) handle, black plastic, matte finish
- Terminals: .250" blade or 8-32 screw



Additional information: Littelfuse.com/ToggleSwitches

PART NUMBERS BULK	PART NUMBERS BOXED	RATING	POLE & THROW	ACTION	ACTUATOR	TERMINALS	CONTACTS
59024-104	-	25A at 12V DC	SPDT	On-On	Black Plastic Duck Bill Paddle	3 blade	Silver
59024-106	59024-106-BX		SPDT	On-Off-On		3 blade	
-	59024-108-BX		SPDT	Mom On-Off-Mom On		3 blade	
59024-110	59024-110-BX		DPST	On-Off		4 blade	
59024-116	-		DPDT	On-On		6 blade	
59024-118	-		DPDT	On-Off-On		6 blade	
59024-200	59024-200-BX		SPST	On-Off		2 screw	
59024-218	-		DPDT	On-Off-On		6 screw	

25A59024-00 Series • Freightliner Replacement “Duck Bill”

Black phenolic switch housing with metal cap. Terminals are arranged to match OEM wiring connectors with or without brackets.

- Fits panels to .093" (2.4mm) with spacer provided, or to .25" (6.4mm) without spacer
- 15/32"-32 thread mounting stem
- Includes mounting hardware: black metal facenut. Keyway is in the down position
- Black plastic 1" (25.4mm) handle, matte finish
- Dual contacts for extra durability

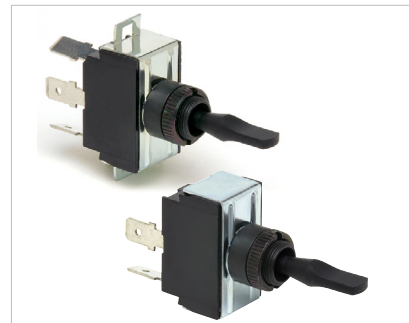

Additional information: Littelfuse.com/ToggleSwitches

PART NUMBERS BULK	PART NUMBERS BOXED	RATING	POLE & THROW	ACTION	ACTUATOR	TERMINALS	CONTACTS	DUAL CONTACTS	MOUNTING BRACKET
59024-33	59024-33-BX	25A at 12V DC	SPST	On-Off	Black Plastic Duck Bill Paddle	2 blade	Silver	•	•
59024-35	59024-35-BX		DPST	On-Off		4 blade		•	
59024-36	59024-36-BX		DPDT	On-Off-On		6 blade		•	
59024-38	59024-38-BX		DPDT	Mom On-On-Mom On		6 blade		•	
59024-12	59024-12-BX		SPST	On-Off		2 blade		•	
59024-14	59024-14-BX		DPST	On-Off		4 blade			
59024-15	59024-15-BX		DPDT	On-Off-On		6 blade			

Toggle Switches and Accessories

Specialized Application Toggle Switches

- Specialized toggle switches have specific functions and applications. See the "APPLICATION NOTES" column below for details
- 15/32"-32 thread mounting stem, .46" (11.9mm) long, mounts in panels up to 9/32" (7.1mm) thick
- Nickel-plated brass handle: standard .687" (17.5mm) or long 1.5" (38.1mm)

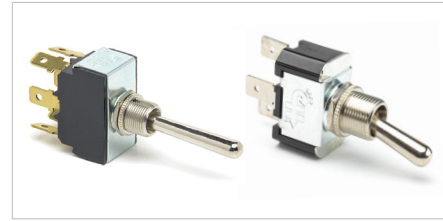

Additional information: Littelfuse.com/ToggleSwitches

PART NUMBERS BULK	PART NUMBERS BOXED/BP	RATING	POLE & THROW	ACTION UP	ACTION CENTER	ACTION DOWN	ACTUATOR HANDLE LENGTH	ACTUATOR MATERIAL	TERMINALS	CONTACTS	SEALING
55064	55064-BX	25A at 12V DC	DPDT 4-circuit	Park, Tail & Headlamps	Off	Park, Tail & Auxiliary Lamps	Long	Nickel-Plated Brass	6 Blade	Silver	4-Circuit Headlamp Switch
55071	-		DP 2-circuit	Mom On B, 1&2 (Day Signaling)	On 1&2	Mom Off (Night Signaling)	Standard	Nickel-Plated Brass	3 Blade	Silver	2-Circuit Marker Lamp Switch
55015-03	55015-03-BX		SPDT	On	-	On	Standard	Nickel-Plated Brass	3 Blade	Silver	3-way Lighting Switch
59071	59071-BX		DP	Mom On 1, 4&5	On 4&5	Off	Standard	White Plastic	3 Blade	Silver	Ignition/Start
55093	55093-BX	-	SPDT	On	On	Off	Standard	Nickel-Plated Brass	3 Blade	Silver	Two Speed Heater Fan Toggle Switch
M-597	M-597-BP	-	SPST	On	-	Mom On	Standard	Nickel-Plated Brass	3 Leads	Silver	Marine Safety Switch

Wiring Diagrams

3-way lighting permits a light (or a set of lights) to be controlled from two switches usually mounted in different locations. Similarly, 4-way lighting enables control from three switch locations.

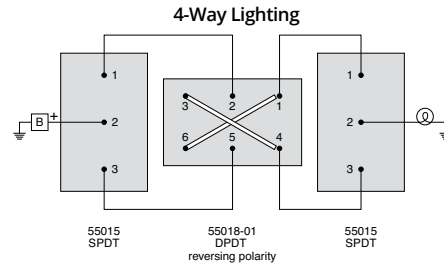
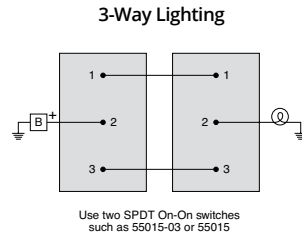

Toggle Accessories



82468 (open)



82468 (closed)



5543



5543-15



81255



81264



81264-01

PART NUMBERS BULK	PART NUMBERS BOXED	PART NUMBERS RETAIL	DESCRIPTION
82468	82468-BX	-	Flip Cover Switch Guard
5543	5543-BX	-	5558 switch mounted in 5543-15 Recessed Faceplate Switch Guard
5543-15	5543-15-BX	-	Recessed Faceplate Switch Guard
81255	81255-BX	81255-BP	Half-Boot Seal
81264	81264-BX	81264-BP	Grey Boot Seal (other colors available, please contact Littelfuse)
81264-01	81264-01-BX	81264-01-BP	Black Boot Seal (other colors available, please contact Littelfuse)
81264-05	81264-02-BX	-	Red Boot Seal (other colors available, please contact Littelfuse)
5543-09	-	-	55015-12 switch mounted Recessed Faceplate Switch Guard
81264-07	81264-07-BX	-	Yellow Boot Seal (other colors available, please contact Littelfuse)
8250	8250-BX	-	Toggle Switch "ON - OFF" Face Plate Cover
M-598	-	M-598-BP	Toggle Marine Emergency Lanyard

* Please inquire about additional bulk quantities

Switch Diagrams

Switch Reference Guide - SPST, SPDT, DPST, DPDT

SP and DP refer to single pole and double pole, ST and DT refer to single throw and Double throw.

SP: Single Pole, one circuit controlled by the switch.

DP: Double Pole, two independent circuits controlled by the switch which are mechanically linked.

Note: "Pole" should not be confused with "Terminal". The DPST switch, for example has four terminals however it is a Double Pole (DP) and not a four pole (4P) switch.

ST: Single Throw, closes a circuit at only one position and with one throw.

DT: Double Throw, closes a circuit in the up or down position (On-On). A Double Throw switch can also have a center position such as On-Off-On.

The following switch diagrams illustrate the most common types of toggle and rocker switch.

SPST On-Off

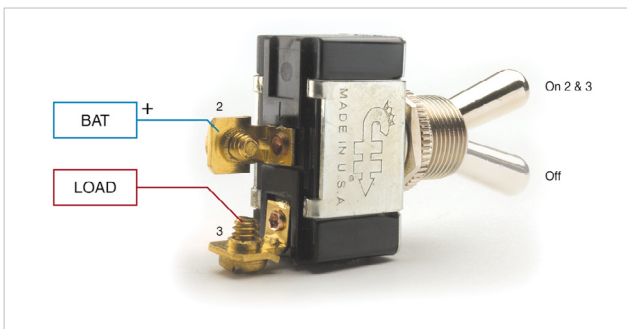

DPST On-Off

Both load terminals can be energized at the same time. They are independent of each other and could be of different voltages.

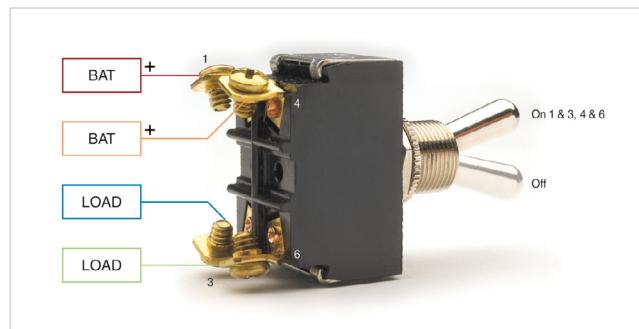

SPDT On-On

Only one of the loads can be energized at a time.

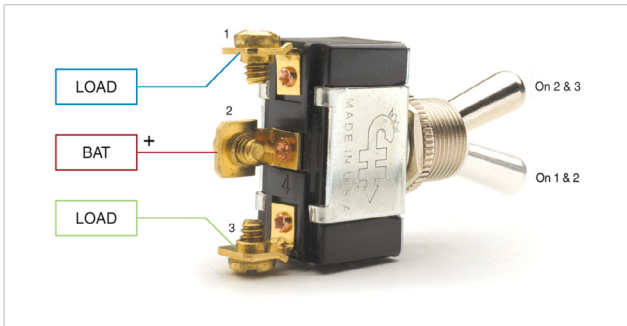

DPDT On-On

Functions like two separate SPDT switches operated by the same actuator. Only two loads can be On at a time.

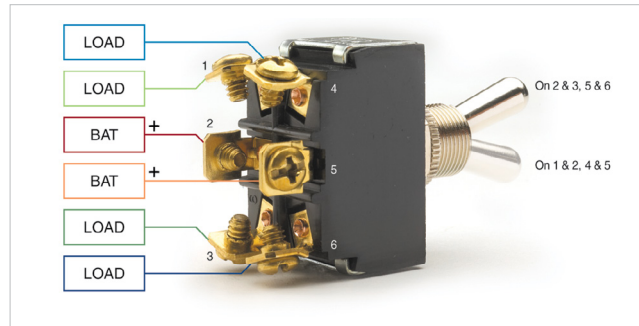

SPDT On-Off-On

Only one of the loads can be energized at a time.

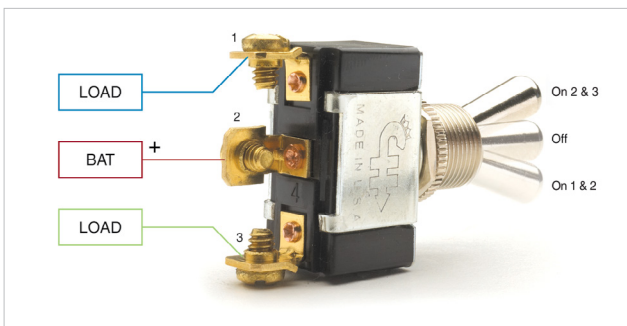

DPDT On-Off-On

Functions like two separate SPDT switches operated by the same actuator. Only two loads can be On at a time.

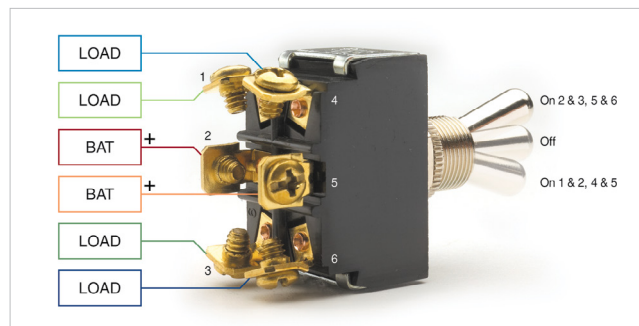

Switch Diagrams

Single-Pole (SP) & Double-Pole (DP) Switch Wiring Diagrams

Diagrams represent both momentary contact or maintained contact switches.

Switches without Pilot Lights

SPST Off-ON
(2 terminals) Diagram A

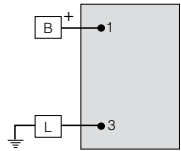
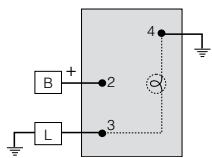
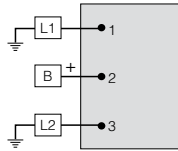

Diagram A1



SPDT On-Off-On
(3 terminals) Diagram B



-

DPST Off-Off (4 terminals)
Diagram C

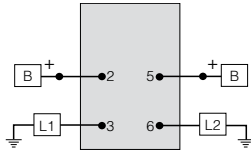
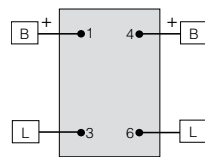
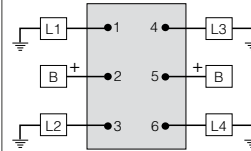

Diagram C1



DPDT On-On (6 terminals)
Diagram D



-

DPDT On-Off-On (6 terminals)
Diagram E

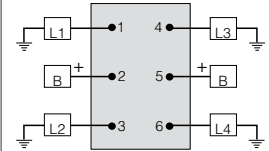

-

Switches with One Pilot Light

SPST Off-ON – Dependent Illumination
(Three terminals)
Diagram F

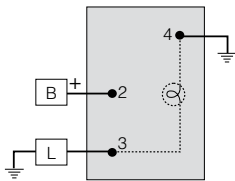

SPST Off-Off – Independent Illumination
(Four terminals)
Diagram G1

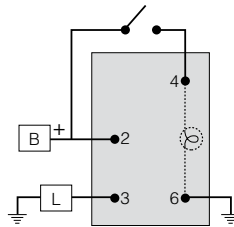

SPST Off-Off – Independent converted to
Dependent
(4 terminals)
Connect jumper wire from T3 to T6 and connect
T4 to ground
Diagram G2

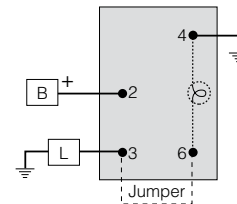

Switches with Two Pilot Lights

SPST Off-Off with Dependent & Independent
Lights
(Four terminals)
Diagram H

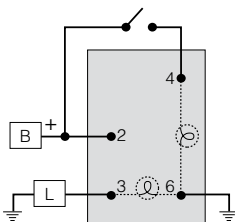

SPDT On-Off-On or On-On with
Dependent & Independent Lights (Four terminals)
Diagram J

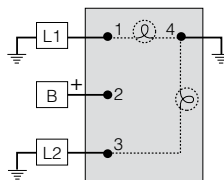

SPDT On-Off-On or On-On with 2 Independent
Lights
(Four terminals)
Diagram K

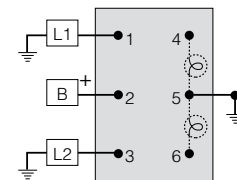

Momentary Switches

Momentary switches operate by pushing a button either by thumb or by the closing of a door and will remain in their switched state as long as they are being actuated. Momentary Switches are either “normally Off, spring return to Off” or “normally On, spring return to On”.

What Does Momentary Mean?

A momentary switch, also known as a “mom”, is spring-loaded. When pressed the actuator moves, remove your finger and it returns to its original position. Opposite of a momentary switch is a maintained contact switch. When the actuator is pressed it stays in the position until it is pressed in the other direction.

More Momentary Switches in Other Sections

Find more momentary switches (moms) in the following catalog sections.

- Ignition Switches
- Rocker Switches
- Toggle Switches
- Push-Pull Switches
- Rotary Switches
- Foot Operated Switches

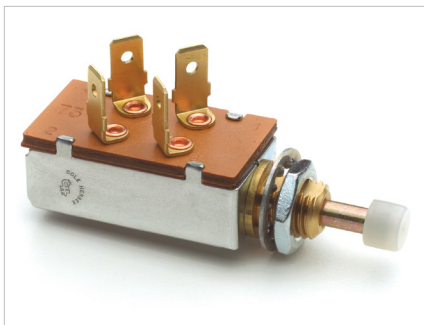

Momentary Push-Button Switches

Heavy Duty Cylindrical Housing • 25A

For applications to 36V DC. On with button depressed, spring return to Off.

Additional information: Littelfuse.com/Push-Button-Switches



PART NUMBERS BULK	PART NUMBERS BOXED	PART NUMBERS RETAIL CLAMSHELL	RATING	POLE & THROW	NORMAL POSITION	ACTUATOR DETAIL	ACTUATOR CAP	TERMINALS	CONTACTS	MOUNTING STEM	NOTES
9095	9095-BX	-	35A at 12V DC 20A at 24V DC	SPST	Normally Off	Chrome Plated Button	-	2 Screw	Silver	5/8"-32 thread 21/32" long	-
-	90036-02-BX	-				Chrome Plated Button	-	2 Blade			Fits Delphi (Packard) 2-way Connector 2973407
9231	9231-BX	-				Recessed Chrome Plated Button	-	2 Screw			Protected Button with Recessed Design
90030	90030-BX	90030-BP				Black Plastic Button	Screw-On Black Rubber	2 Screw			-
90030-01	90030-01-BX	-				Black Plastic Button	Screw-On Brown Oil-Resistant Rubber	2 Screw			-
90030-04	90030-04-BX	-				Black Plastic Button	Screw-On Red Rubber	2 Screw			-
90030-12	-	-				Chrome Plated Button	Black Cap	2 Terminal Wire			-
90030-24	-	-				Chrome Plated Button	Black Cap	2 Screw			-
90030-33	-	-				Chrome Plated Button	Black "Push" Cap	2 Screw			-
90030-43	-	-				Chrome Plated Button	Black Cap	2 Screw			-
90030-53	-	-				Chrome Plated Button	Black Cap	2 Screw			Assembled
90036-10	-	-				Chrome Plated Button	Black Cap	2 Blade			Horn Imprinted
9216-03	9216-03-BX	-				Chrome Plated Button	Screw-On Black Rubber	2 Screw			Gold Dichromate Dipped Case
9100	9100-BX	-				Chrome Plated Plunger	-	2 Screw			-
9216-10	-	-				Chrome Plated Button	Black Cap	Aptiv 12010973 (Sealed)			Sealed Gold Dichromate Dipped Case
9216	9216-BX	-				Chrome Plated Button	-	2 Screw			Sealed Gold Dichromate Dipped Case
9276-09	9276-09-BX	-				Black Plastic Button	Screw-On Black Rubber	2 Screw			Two circuits simultaneously energized
9238-07	-	-				Chrome Plated Button	-	2 Blade			-
90018	-	-				Chrome Plated Button	-	2 Screw			-

Momentary Push-Button Switches

Heavy Duty Rectangular Housing • 10A

For applications up to 36V DC. On with button depressed, spring return to Off.

Additional information: Littelfuse.com/Push-Button-Switches

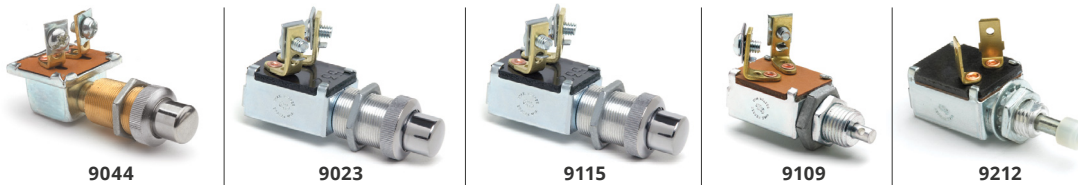

PART NUMBERS BULK	PART NUMBERS BOXED	RATING	POLE & THROW	ACTION	NORMAL POSITION	ACTUATOR DETAIL	ACTUATOR CAP	TERMINALS	MOUNTING STEM	NOTES
-	9044-BX	10A at 12V DC	SPST	Off-On	Off	Chrome Plated Button	-	2 Screw	5/8"-32 thread 1.06" long	Gasket Seal
9023	9023-BX	15A Resistive, 10A Inductive at 12V DC 8A Resistive, 5A Inductive at 24V DC	SPST	Off-On	Off	Chrome Plated Button	-	2 Screw	5/8"-32 thread .87" long	-
9238	9238-BX	15A Resistive, 10A Inductive at 12V DC 8A Resistive, 5A Inductive at 24V DC	SPST	Off-On	Off	Chrome Plated Button	-	2 Blade	5/8"-32 thread .87" long	-
9115	9115-BX	10A at 12V DC	SPST	On-Off	On	Chrome Plated Button	-	2 Screw	5/8"-32 thread 7/8" long	-
9109	9109-BX	10A at 12V DC	SPST	Off-On	Off	Shaft has 3/32" hole for cable or lever attachment	-	2 Screw	1/2"-20 thread 5/8" long	Pull On, Spring Return to Off
9212	9212-BX	10A at 12V DC	SPST	On-Off	On	1/2" Plunger	Nylon Cap	2 Blade	7/16"-20 thread 1/2" long	Brass Contacts
9165	9165-BX	10A at 12V DC	DPST	Off-On	Off	Chrome Plated Button	-	3 Screw	5/8"-32 thread 21/32" long	2 steel hexnuts and facenut on stem
91126	91126-BX	10A at 12V DC	SPST	Off-Mom On	Off	Chrome Plated Plunger	-	2 Wire	7/16"-20 thread 7/16" long	-
92116	92116-BX	10A at 12V DC	SPST	Off-On	Off	Chrome Plated Plunger	Black Cap	2 Blade	5/8"-32 thread 1" long	Hencol Sealed
91109-03	-	20A at 12V DC 10A at 24V DC	DPST	On-On	On	Chrome Plated Button	Black Cap	4 Wire	5/8"-32 thread 3/4" long	Cir. A Normally On, Cir. A Off/Cir. B On when depressed (spring return to A On).

Heavy Duty Rectangular Housing (for Mechanical Activation) • 20A

10A at 24V DC, 20A at 12V DC. On with button depressed, spring return to Off.

- Steel button protrudes through the cap. Black rubber cap snaps into a special groove on the nut, which is deep-threaded and gives a positive seal
- Steel button feature is ideal for mechanical actuation

Additional information: Littelfuse.com/Push-Button-Switches



PART NUMBERS BULK	PART NUMBERS BOXED	RATING	POLE & THROW	ACTION	NORMAL POSITION	ACTUATOR DETAIL	ACTUATOR CAP	TERMINALS	MOUNTING STEM	GASKET SEAL	NOTES
90043	90043-BX	20A at 12V DC 10A at 24V DC	SPST	Off-On	Off	Steel Plunger	Snap-On Black Rubber	2 Blade	5/8"-32 thread .625" long	•	Fits Delphi (Packard) 2-Pole Connector 2977647 • PVC-Coated • Hencol Sealed Body
90043-07	90043-07-BX							2x 7" wire leads			
90043-31	90043-31-BX							2 Wire			

Horn Push-Button

Surface and clamp mount push-button horn switches. Clamp mount allows attachment on a steering column up to 1-1/2" (38.1mm) diameter.

PART NUMBERS BULK	PART NUMBERS BOXED	RATING	TYPE	SIZE	DETAIL	TERMINALS
96101	96101-BX	5A at 12V DC	Surface Mount	13/16"Ø	Black Plastic	2 Screw



Momentary Push-Button Switches

Heavy Duty Marine-Grade • 35-10A

For applications to 36V DC. On with button depressed, spring return to Off

Designed for universal applications within harsh environments. Their mounting, body, and actuator features are designed for ease-of-use and extended product lifecycle. With heavy duty brass bodies, the Marine Push Pull Switches are designed for circuit control within the Marine environment.

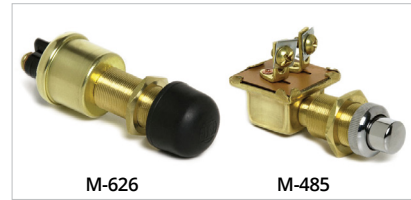

PART NUMBERS BULK	PART NUMBERS BOXED	PART NUMBERS RETAIL CLAMSHELL	RATING	POLE & THROW	ACTION	NORMAL POSITION	ACTUATOR	TERMINALS	MOUNTING STEM	FITS PANELS	NOTES
M-490	M-490-BX	M-490-BP	35A at 12V DC 20A at 24V DC 10A at 36V DC	SPST	Off-On	Off	Chrome Plated	2 screw	5/8"-32 thread 1-3/8" long	1" (25.4mm)	-
M-612	M-612-BX	M-612-BP					Chrome Plated			1" (25.4mm)	With Protected Bezel
M-626	M-626-BX	M-626-BP					Black Rubber Cap (407-03)			1" (25.4mm)	Same as M-490, but with snap-on cap
M-626-02	M-626-02-BX	M-626-02-BP					Black Rubber Cap (83280-03)			1" (25.4mm)	-
M-639	M-639-BX	-	10A at 12V DC	SPST	Off-On	Off	Chrome Plated	5/8"-32 thread 1.0" long	3/4" (19.1mm)	-	
M-485	M-485-BX	M-485-BP					Chrome Plated		3/4" (19.1mm)	Gasket Seal	
M-492	M-492-BX	M-492-BP					Chrome Plated		1" (25.4mm)	-	
M-524	-	-					Black Rubber Cap (407-03)		3/4" (19.1mm)	Gasket Seal	
M-914-01	M-914-01-BX	-				Chrome Plated			3/4" (19.1mm)	-	

Engine Start / Engine Stop Buttons

- Diecast housing, with knurled aluminum facenut
- Two screw terminals with lockwashers
- Mounting stem 7.8"-24 thread, keyed to prevent turning, fits panels .04" - .10" thick (1.0 - 2.5mm)
- Impact-resistant molded plastic button with white imprint, repels oil, water and other liquids
- 2 7/32"L x 1 1/8"D (50.8 x 28.6 x 3.18mm)



PART NUMBERS BULK	PART NUMBERS BOXED	RATING	POLE & THROW	ACTION	NORMAL POSITION	DETAIL	IMPRINT	TERMINALS	CONTACTS	MOUNTING STEM	SEALING
90047	90047-BX	35A at 12V DC 20A at 24V DC	SPST	Off-On	Off	Black Plastic Button	Start	2 screw	Silver	7/8"-24 thread	-
90047-01	90047-01-BX					Black Plastic Button	Start				Built-In Seal Around Lip
90048	90048-BX					Red Plastic Button	Stop				-
90048-01	90048-01-BX					Red Plastic Button	Stop				Built-In Seal Around Lip

PVC-Coated Heavy Duty Rectangular Housing • 10A

For applications to 36V DC. On with button depressed, spring return to Off.

- Corrosion-resistant brass case
- PVC-Coated body sealed against moisture and dirt, with black rubber snap-on cap (407-03)
- Fits panels up to 1/2" (12.7mm) thick



Additional information: Littelfuse.com/Push-Button-Switches

PART NUMBERS BULK	PART NUMBERS BOXED	PART NUMBERS RETAIL CLAMSHELL	RATING	POLE & THROW	ACTION	NORMAL POSITION	ACTUATOR DETAIL	ACTUATOR CAP	TERMINALS	MOUNTING STEM	PVC COATED
M-608	M-608-BX	M-608-BP	10A at 12V DC	SPST	Off-On	Off	Brass Button	Rubber	2 wire leads	5/8"-32 thread 15/16" long	•

Compact Design • 5A

- Moisture-resistant molded plastic case
- Snaps into .80 - .85" (20.3 - 21.6mm) diameter hole. Fits panels .03 - .07" thick (.76 - 1.8mm)
- Normally off black, white or red button compact switch



PART NUMBERS BULK	PART NUMBERS BOXED	PART NUMBERS RETAIL	RATING	POLE & THROW	ACTION	NORMAL POSITION	DETAIL	TERMINALS
9075	9075-BX	-	5A at 12V DC	SPST	On-Mom Off	On	Black Plastic 9/16" long	2 Female Bullet
9187-02	-	9187-02-BP			Off-Mom On	Off	Red Button	2 Blade
9187	9187-BX	9187-BP			Off-Mom On	Off	Red Button	2 Blade

Momentary Push-Button Switches

Threaded and Push-Button Caps

- Threaded rubber cap is permanently fastened to the integral mounting nut by a rolled brass bezel
- Snap-on rubber caps feature ribs on the inside of the rubber cap engage with the switch facenut

PART NUMBERS BULK	PART NUMBERS BOXED	PART NUMBERS RETAIL	TYPE	COLOR	IMPRINT	NOTES
83280	83280-BX	-	Screw-On - 5/8"-32 threads	Grey	Push	-
83280-02	83280-02-BX	-		Red		-
83280-03	83280-03-BX	83280-03-BP		Black		-
83280-05	83280-05-BX	-		Brown		Molded from Hydrin which is more resistant to fuel and oils
407-01	-	-	Snap-On	Grey		Snaps on to 83261 face nut
407-02	-	-		Red		
407-03	407-03-BX	407-03-BP		Black		

Momentary Door Switches

Specialized Door Momentary Switches • 10A

- Designed for 8 light warning systems in school buses.
- 91811: Two circuits, progressive plunger travel alternates the circuits.
- 91800: Pull out feature permits circuit to be shut off manually when the door must remain open but flashing lights operation is not required.

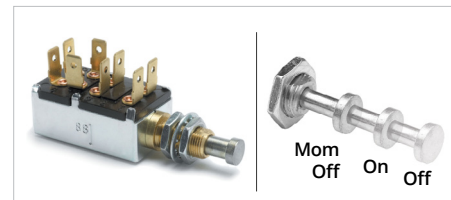

Additional information: Littelfuse.com/Door-Switches

PART NUMBERS BULK	PART NUMBERS BOXED	POLE & THROW	POSITIONS	ACTION	NORMAL POSITION	ACTUATOR DETAIL	ACTUATOR LENGTH	TERMINALS	CASE	CONTACTS	MOUNTING
91050	91050-BX	TPTT	2	On-Mom Off	On	Button	3/10"	8 Blade	Plated Steel	Silver	7/16"-20 thread, 7/16" long Two Flats for Double-D Mounting

Door Momentary Switches with Faceplate • 5A

Additional information: Littelfuse.com/Door-Switches



PART NUMBERS BULK	PART NUMBERS BOXED	RATING	POLE & THROW	ACTION	NORMAL POSITION	ACTUATOR DETAIL	ACTUATOR LENGTH	ACTUATOR DIAMETER	TERMINALS	CASE	CONTACTS	MOUNTING
9001	9001-BX	5A at 12V DC	SPST	On-Mom Off	Normally On	Rounded	7/16"	45/64"	2 Screw	Plated Steel	Silver	Two 9/64"Ø Mounting Holes; 1-3/8" on Center
9050-01	9050-01-BX								1 Screw			
9270	9270-BX			2 Blade								
-	9087-BX			2 Screw								
-	9002-BX	2 Screw	Off-Mom On	Normally Off							Two 9/64"Ø Mounting Holes; 1-3/8" on Center	
9269	9269-BX								2 Blade			Two 9/64"Ø Mounting Holes; 1-1/2" on Center

Momentary Door Switches

SPST • 10-5A

Additional information: Littelfuse.com/Door-Switches



PART NUMBERS BULK	PART NUMBERS BOXED	RATING	POLE & THROW	POSITIONS	ACTION	NORMAL POSITION	ACTUATOR DETAIL	ACTUATOR LENGTH	TERMINALS	CASE	CONTACTS	MOUNTING
9055	9055-BX	10A at 12V DC	SPST	2	On-Mom Off	On	Shaft	1/2"	2 Screw	Plated Steel	Silver	7/16"-20 thread, 7/16" long Two Flats for Double-D Mounting
9264-04	-	-					Button	7/16"				-
9264-02	9264-02-BX	10A at 12V DC					Button	1/2"				7/16"-20 thread, 7/8" long Two Flats for Double-D Mounting
9003	9003-BX	5A at 12V DC					Rounded	3/32"				1/2"-20 thread 1/14" long
9055-08	-	20A at 12V DC				Off	Shaft	1/2"	2 Blade	7/16"-20 thread, 7/8" long Two Flats for Double-D Mounting		

DPST • 10A

- Energizes two circuit simultaneously.
- Popular for use in school bus stepwell and door control.

Additional information: Littelfuse.com/Door-Switches

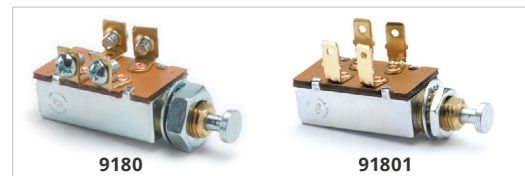

PART NUMBERS BULK	PART NUMBERS BOXED	RATING	POLE & THROW	POSITIONS	ACTION	NORMAL POSITION	ACTUATOR DETAIL	ACTUATOR LENGTH	TERMINALS	CASE	CONTACTS	MOUNTING
91801	91801-BX	10A at 12V DC	DPST	2	On-Mom Off	On	Button	19/64"	4 Blade	Plated Steel	Silver	7/16"-20 thread, 7/16" long Two Flats for Double-D Mounting
9180	9180-BX				Off-Mom On			15/32"	4 Screw			
9118-04	9118-04-BX				On-Mom Off			19/64"	4 Screw			

Normally Grounded Single Circuit • 5A

Additional information: Littelfuse.com/Door-Switches



PART NUMBERS BULK	PART NUMBERS BOXED	RATING	POLE & THROW	ACTION	NORMAL POSITION	ACTUATOR DETAIL	ACTUATOR LENGTH	TERMINALS	CASE	CONTACTS	MOUNTING
91812	91812-BX	5A at 12V DC	SPST	On-Mom Off	Normally Grounded	Rounded	33/64"	1 Blade	Plated Steel	Silver	7/16"-20 thread, 7/16" long Two Flats for Double-D Mounting
91812-02	-					Chrome Plated Plunger		1 Blade; 1 Wire			

Sealed with Faceplate • 5A

- Sealed Plunger and wire leads.

Additional information: Littelfuse.com/Door-Switches



PART NUMBERS BULK	PART NUMBERS BOXED	RATING	POLE & THROW	ACTION	NORMAL POSITION	ACTUATOR DETAIL	ACTUATOR LENGTH	ACTUATOR DIAMETER	TERMINALS	CASE	CONTACTS	MOUNTING
9270-01	9270-01-BX	5A at 12V DC	SPST	On-Mom Off	Normally On	Round Black Rubber Cap	.436"	.70"	2 PVC Coated 8" Wire Leads	Plated Steel	Silver	Two .144"Ø Mounting Holes 1-1/2" on Center

Push-Pull, Rotary and Foot Switches



What is the Difference Between Push-Pull, Rotary and Foot Switches?

Push-Pull switches operate by pushing or pulling the actuator depending on the configuration of the switch.

Rotary switches are activated by a manual rotation of the actuator into two or three positions.

Foot switches are mounted on or through the floorboard for hands free operation of the application.

What is Dynamic Parking in Wiper Switches?

Windshield wiper switch engineers call the feature 'dynamic parking' when the windshield wiper switch actively returns the wiper to home position, rather than waiting until the cycle reaches home.

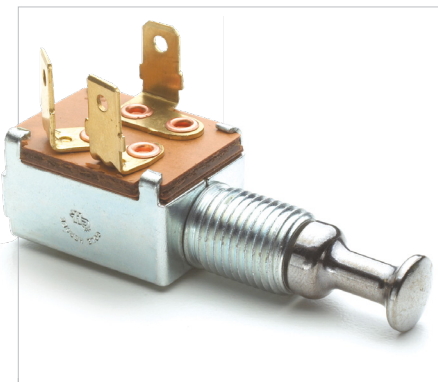

Push-Pull Switches

One and Two Circuit



													MOUNTING STEM	
PART NUMBERS BULK	PART NUMBERS BOXED	VOLTS	RATING	CIRCUITRY	TYPE	NORMAL POSITION	ACTUATOR KNOB	TERMINALS	CONTACTS	HOUSING	MATERIAL	SIZE	NOTES	
5007	5007-BX	6-36V DC	10A at 12V DC	SPST	Off-On	Off	Tan Plastic (10-32 metal thread)	2 screw	Copper	Plated Steel	Aluminum	3/8"-32 thread 5/8" long	-	
5011	5011-BX		10A at 12V DC	SPST	Off-On	Off	Chrome	2 screw	Copper		Steel	1/2"-20 thread 5/8" long	-	
50070	50070-BX		10A at 12V DC	SPST	Off-On	Off	Chrome	2 blade	Silver		Steel	1/2"-20 thread 5/8" long	-	
50001	50001-BX		10A at 12V DC	SPST	Off-On	Off	Black Plastic (10-32 metal thread)	2 screw	Silver		Brass	1/2"-20 thread 5/8" long	-	
50002	50002-BX		20A at 12V DC	SPST	Off-On	Off	Integral Chrome Brass	2 screw	Silver		Brass	1/2"-20 thread 5/8" long	-	
50066	50066-BX		20A at 12V DC	SPST	Off-On	Off	Black Plastic (10-32 metal thread)	2 screw	Silver		Brass	1/2"-20 thread 5/8" long	O-Ring stem seal & Gasket Sealed Terminal Insulator	
50046-09	-		10A at 12V DC	SPST	On-Off	On	Plunger	2 screw	Copper		Aluminum	3/8"-32 thread 5/8" long	-	
5050	-		20A at 12V DC	DPST	On-Off	Off	Black Plastic "Lights" (10-32 metal thread)	2 screw & 1 stud	Silver		Steel	1/2"-20 thread 5/8" long	Includes 30A Circuit Breaker	
50088	50088-BX	8A at 12V DC	TPTT	Off-On-Off	On	Steel Plunger	3 screw	Silver	Aluminum	7/16"-28 thread 5/16" long	-			

Marine Grade • One, Two & Three Circuit

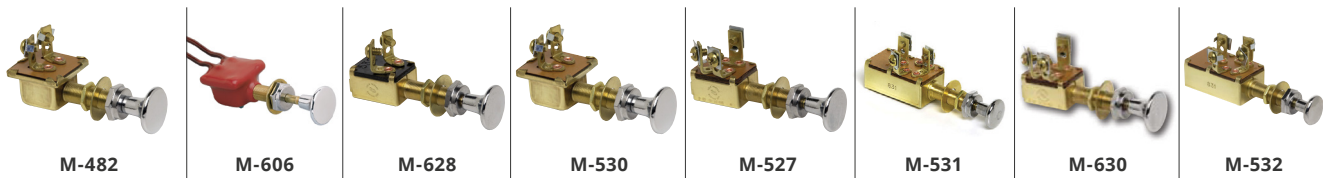

													MOUNTING STEM		
PART NUMBERS BULK	PART NUMBERS BOXED	PART NUMBERS RETAIL	VOLTS	RATING	CIRCUITRY	TYPE	NORMAL POSITION	ACTUATOR KNOB	TERMINALS	CONTACTS	HOUSING	GASKET SEALED	MATERIAL	SIZE	
M-482	M-482-BX	M-482-BP	6-36V DC	10A at 12V DC	SPST	Off-On	Off	Chrome	Brass	2 screw	-	Brass	•	Brass	3/8"-32 1 1/4" long
M-606	M-606-BX	M-606-BP			SPST	Off-On	Off	Chrome	Brass (10-32 thread)	2 copper 12" wires	-	Brass - PVC Coated	-		
M-628	M-628-BX	M-628-BP			SPST	Off-On	Off	Chrome	Brass (10-32 thread)	2 screw	-	Brass	-		
M-530	M-530-BX	-			SPST	On-Off	On	Chrome	Brass	2 screw	-	Brass	•		
M-527	-	M-527-BP			SPST	On-Off	Off	Chrome	Brass	3 screw	-	Brass	-		
M-531	M-531-BX	M-531-BP			SPST	On-On-Off	Off	Chrome	Brass (10-32 thread)	3 screw	-	Brass	-		
M-630	M-630-BX	-			SPDT	On-On	Off	Chrome	Brass	3 screw	-	Brass	-		
M-532	M-532-BX	M-532-BP			SPDT	Off-On1-On2	Off	Chrome	Brass (10-32 thread)	4 screw	-	Brass	-		

Push-Pull Switches

Push-Pull Headlamp Switches

- Three knob pull positions: In – Mid – Out
- In = Headlamps Off
- Mid = Parking Lights and Tail Lights On
- Out = Headlights and Tail Lights On

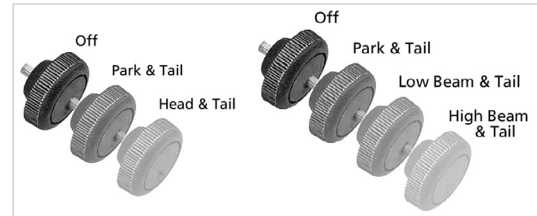

Additional information: Littelfuse.com/PushPullSwitches

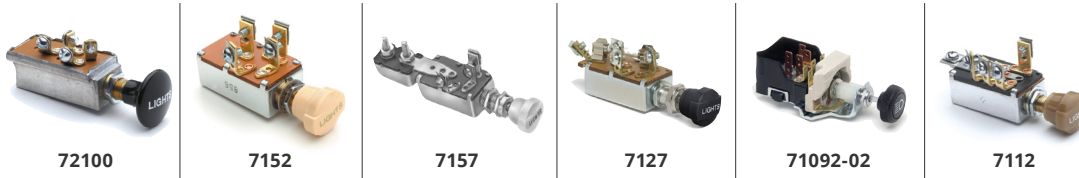

PART NUMBERS BULK	PART NUMBERS BOXED	RATING PER CIRCUIT	POSITIONS	TYPE	ACTUATOR KNOB	ACTUATOR IMPRINT	TERMINALS	CONTACTS	HOUSING	MOUNTING STEM	NOTES
7124-06	7124-06-BX	-	3	In-Mid-Out	Black Plastic	Lights	4 screw	Bronze	Plated Steel	7/16"-28	-
72100	72100-BX	20A at 12V DC		In-Mid-Out	Black Plastic	Lights	4 screw	Silver	Diecast	7/16"-28	O-Ring Seal in Stem & Gasket Sealed Terminal Insulator
7152	7152-BX	15A at 12V DC		In-Mid-Out	Ivory Plastic	Lights	4 screw	Silver	Plated Steel	3/8"-24	-
7157	7157-BX	30A at 12V DC with Breaker		In-Mid-Out	Ivory Plastic	Lights	3 screw	Silver	Plated Steel	7/16"-28	Includes 30A Circuit Breaker
7127	7127-BX	20A at 12V DC with Fuse		In-Mid-Out	Black Plastic	Lights	4 screw	Copper	Plated Steel	7/16"-28	Includes 20A Glass Fuse
71092	71092-BX	15A at 12V DC with Internal Breaker		In-Mid-Out	None	None	8 blade*	-	Plated Steel	7/16"-28	4.5 Ω with Internal 15A Circuit Breaker
71092-02	71092-02-BX	15A at 12V DC with Internal Breaker	4	In-Mid-Out	None	None	8 blade*	-	Plated Steel	7/16"-28	4.5 Ω with Internal 15A Circuit Breaker
7112	7112-BX	10A at 12V DC		In-Mid1-Mid2-Out	Tan Plastic	Lights	5 screw	Copper	Plated Steel	3/8"-24	-

*Accepts Delphi 2977645 or 2984169

Specialized Push-Pull Switches

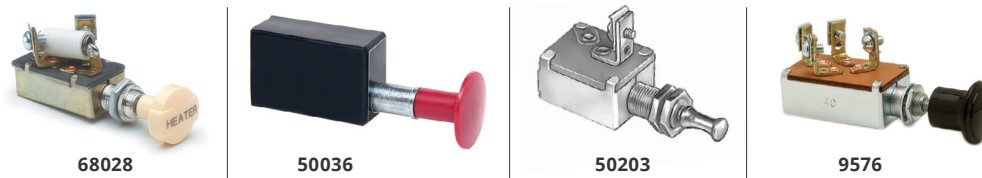

PART NUMBERS BULK	PART NUMBERS BOXED	VOLTS	POSITIONS	TYPE	ACTUATOR KNOB	TERMINALS	CONTACTS	HOUSING	MOUNTING STEM MATERIAL	MOUNTING STEM SIZE	NOTES
68028	68028-BX	12V DC	3	Off-Hi-Lo	Ivory Plastic (10-32 Metal Thread) Gold Imprint: Lights	2 screw	Copper	Plated Steel (1-13/16"x 1-19/32"x 1/2")	Steel	7/16"-28 thread 5/16" long	Heater switch 3Ω coil resistance
50036	50036-BX	12V DC	2	On-On (DPST)	Red Plastic 1-1/4" Ø	3 female bullet	Copper	Zinc with Rubber Boot	-	-	Two-speed axle switch to mount on gear shift lever. Accepts 40102 connector
50203	-	10A at 12V 36V DC max	2	In-Off (Magneto Switch Grounded) Out-Run (Magneto Switch Open)	Integral Nickel Plated	1 screw	Copper	Plated Steel	Aluminum	3/8"-32 thread 5/8" long	Magneto Switch, Out-Run
9576	9576-BX	12V DC	2	Off-Ign/Acc-Ign/Start 10A Acc, 5A Ign, 5A Start	Black Plastic	4 screw	Copper	Plated Steel	Steel	3/8"-24 thread	Battery ignition and starter switch - spring return to Ign/Acc
9011	9011-BX	-	2	Off-Start	Chrome Plated Button	2 screw	Copper	Plated Steel	Steel	1"-22 thread 17/32" long	Engine Start / Engine Stop Button

Rotary Switches

Universal Rotary Switches

In a full range of styles and circuitries for lighting, ignition and similar applications.

- For forward-reverse operation of a motor, to give a motion such as Up/Down, Left/Right, In/Out, Rotate/Counter-rotate
- Suitable for control of tailgates, winches, windlasses, snowplows and other applications

Additional information: Littelfuse.com/RotarySwitches

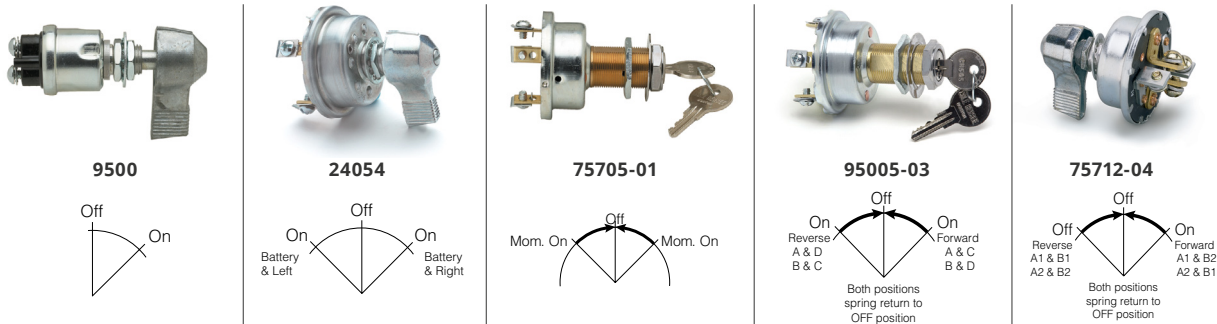

PART NUMBERS BULK	PART NUMBERS BOXED	RATING	CIRCUITRY	POSITIONS	SWITCH TYPE	TYPE	ACTUATOR	TERMINALS	HOUSING	MOUNTING STEM	NOTES
9500	9500-BX	10A at 12V DC	SPST	2	-	Off-On	Lever	2 screw	Plated Steel	1/2"-20	Compact Case
9096-02	9096-02-BX	5A at 12V DC	SPST	2	Momentary	On-Off	Plunger	Bullet	Plated Steel	2-13/64"	-
24054	-	10A at 12V DC	SPST	3	-	On1-Off-On2	Lever	3 screw	Plated Steel	1/2"-20	-
75701	75701-BX	20A at 12V DC	-	3	Reverse	On1-Off-On2	Lever	3 screw	Plated Steel	7/16"-28	-
72171-02	-	20A at 12V DC	-	3	Rotary	Off-On-On	Black Knob (Fan Icon)	6 blade	Copper	11/32"-12	Universal rotary or fan control types of products
75602-10	-	24V DC	-	4	-	-	Aptiv 2977042	6 Way Male Connector	Diecast	13/16"-24	-
90005-01	90005-01-BX	15A at 12V DC	DPDT	3	Reverse	On (Reverse); Off; On (Forward)	Lever	4 screw	Plated Steel	1/2"-20	Spring Return to Off
75705-01	75705-01-BX	10A at 12V DC	-	3	Momentary	Mom On1-Off-Mom On2	Key with Coded Tumbler Lock	3 screw	Plated Steel	13/16"-24	Internal O-Ring Seal; Spring Return to Off from Both Positions
90005-03	90005-03-BX	15A at 12V DC	DPDT	3	Reversing	Off (Reverse)-Off-On (Forward)	Key with Coded Tumbler Lock	4 screw	Plated Steel	13/16"-24	O-Ring Seal in Stem
75712-04	75712-04-BX	50A at 12V DC	DPDT	3	Momentary Reversing	Mom Off (Reverse)-Off-Mom On (Forward)	Lever	4 screw 3/32" thick	Plated Steel	1/2"-20	High Amp Silver Contacts

Universal Rotary Switches

Ceramic insulator with embedded coil for effective heat dissipation.



PART NUMBERS BULK	PART NUMBERS BOXED	VOLTS	RESISTANCE	POSITIONS	ACTUATOR KNOB	ACTUATOR IMPRINT	TERMINALS	HOUSING	MOUNTING STEM	DIMENSIONS
7493	7493-BX	12V DC	8 Ohms	3	Black Plastic Bar Knob	-	2 screw	Plated Steel	7/16"-28 15/32" long	1.32"Ø .88" long (33.5mm Ø 22.4mm long)
7493-07	-					Panel Lamps				

Heater-Defroster Switches

Coil embedded in ceramic insulator for effective heat dissipation.

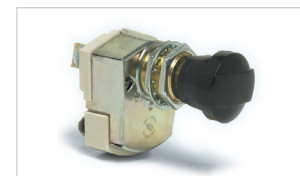

PART NUMBERS BULK	PART NUMBERS BOXED	VOLTS	RESISTANCE	POSITIONS	TYPE	ACTUATOR	TERMINALS	MOUNTING HOLE
68362	68362-BX	12V DC	3 Ohms	4	Off-High-Medium-Low	Black Plastic Bar Knob	2 screw	5/8" Through-Hole

Rotary Wiper Switches

Electronic Windshield Wiper Switches

Universal application. For stem- or bracket-mounting. 15/32"-32 thread mounting stem, with keyway.

- Intermittent delay feature for permanent magnet electric wiper motors
- Negative ground only
- Four positions: Off/Park - Intermittent Range - Low - High
- 7/16"-28 x .45" (11.3mm)
- Round black plastic, white imprinted knob with metal insert and set screw included unless noted otherwise
- Controls single motor unless noted otherwise
- Conforms to SAE J1455, SAE J112a, and SAE J234

Additional information: Littelfuse.com/WiperSwitches

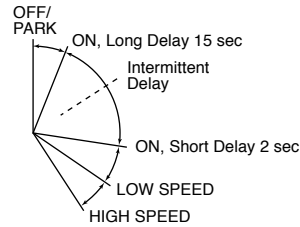
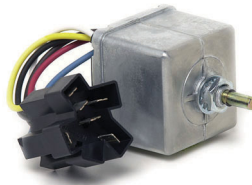
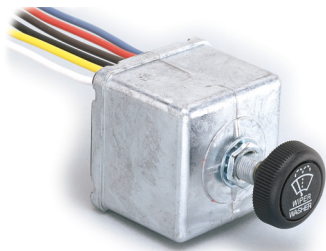

PART NUMBERS BULK	PART NUMBERS BOXED	VOLTS	POSITIONS	CONNECTOR	HOUSING	DIMENSIONS	DYNAMIC PARKING	PUSH-TO-WASH	NOTES
75600	-	12V DC		Delphi 2965977 8-way female connector	Diecast	2 7/32" x 2 7/32" x 1 13/16" (56.4mm x 56.4mm x 46.0mm)	•	•	-
75600-01	75600-01-BX	12V DC		Delphi 6294544 4-way male and Delphi 2977042 6-way male connectors			•	-	Controls two motors in phase at the same speed. With or without dynamic parking (based on motor capabilities)
75600-02	75600-02-BX	12V DC		Delphi 2977042 6-way male connector			•	•	-
75600-04	75600-04-BX	12V DC	4	Color-coded leads			•	•	-
75600-05	-	12V DC		Delphi 6294544 4-way male and Delphi 2977048 4-way female connectors			•	•	-
75600-07	75600-07-BX	12V DC		7 pole connector			•	•	-
75602-02	-	24V DC		Delphi 6294544 4-way male and Delphi 2977042 6-way male connectors			•	-	Controls two motors in phase at the same speed. With or without dynamic parking (based on motor capabilities)
75600-25	-	12V DC	6	Six Pin AMP Connector #640585-1	-	•	-		
75601-14	75601-14-BX	12V DC		Delphi (Packard) 8-way male connector 2965972 (mates with 2965977).	Diecast	2 7/32" x 2 7/32" x 1 13/16" (56.4mm x 56.4mm x 46.0mm)	-	•	Controls one or two motors
75603-09	-	24V DC	5	Nine Pin AMP 1-480707-0 Connector			-	•	-
75602-04	75602-04-BX	24V DC			Diecast	2 7/32" x 2 7/32" x 1 13/16" (56.4mm x 56.4mm x 46.0mm)	•	•	-
75603-08	-	24V DC	4	Color-coded leads			-	•	-

Rotary Wiper Switches

Electronic Windshield Wiper Switches

Universal application. For stem- or bracket-mounting. 15/32"-32 thread mounting stem, with keyway.

- Intermittent delay feature for permanent magnet electric wiper motors
- Negative ground only
- Four positions: Off/Park - Intermittent Range - Low - High
- 7/16"-28 x .45" (11.3mm)
- Round black plastic, white imprinted knob with metal insert and set screw included unless noted otherwise
- Controls single motor unless noted otherwise
- Conforms to SAE J1455, SAE J112a, and SAE J234

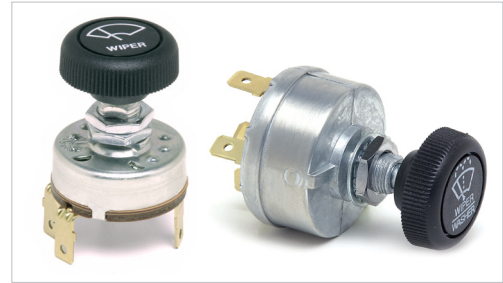

Additional information: Littelfuse.com/WiperSwitches

PART NUMBERS BULK	PART NUMBERS BOXED	VOLTS	POSITIONS	TERMINALS	HOUSING	MOUNTING STEM	DIMENSIONS	DYNAMIC PARKING	PUSH-TO-WASH	NOTES
68159-05	68159-05-BX	12V DC	3	5 blade	Plated steel	7/16"-28 x .38" (9.6mm)	1 3/8" Ø x 3/8" (34.9mm Ø x 9.5mm)	-	-	No electrical break between positions
75212-04	75212-04-BX	12V or 24V DC		4 blade				-	•	-
75217-04	-	12V or 24V DC		6 blade				-	-	Controls two motors
75221-06	75221-06-BX	12V DC		4 blade				-	-	Internal 6A circuit breaker
75221-09	75221-09-BX	12V DC		5 blade				-	•	Internal 6A circuit breaker
75226	75226-BX	12V or 24V DC		7 blade				-	•	Controls two motors
75228-03	75228-03-BX	12V or 24V DC		6 blade	Diecast		1 5/8" Ø (41.3mm Ø)	•	•	-
75228-04	75228-04-BX	12V or 24V DC		5 blade				•	-	-
75236	75236-BX	12V or 24V DC		8 blade				•	•	Controls two motors

Wiper Switch Accessories



81298-02



81298-34

PART NUMBERS BULK	PART NUMBERS BOXED	IMPRINT	FACE DIAMETER	MATERIAL
81298-02	81298-02-BX	SAE wiper symbol	1 3/16" Ø	Black plastic
81298-34	81298-34-BX	SAE wiper-washer symbol	1 3/16" Ø	Black plastic

Rotary Headlamp Switches

Headlamp Dimmer Switches

- For variable intensity control of lighting applications
- For use in negative ground systems
- Black plastic knob with metal insert and set screw
- Knob imprinted in white with SAE variable symbol
- Diecast case: 1 9/16"Ø (39.7mm) by .883" (22.4mm) long

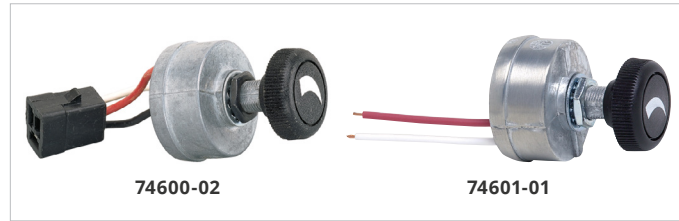

Additional information: Littelfuse.com/RotarySwitches

PART NUMBERS BULK	PART NUMBERS BOXED	PART NUMBERS RETAIL	RATING	DUTY CYCLE	CONNECTOR	CASE MATERIAL	CASE DIMENSIONS	MOUNTING STEM
74600-02	-	74600-02-BP	4A at 12V DC	0-100%	3 wire (Load, Battery & Ground) Delphi 2984378 connector on 3" (76.2mm) leads	Diecast	1 9/16" Ø x .883" 39.7mm Ø x 22.4mm	7/16"-28 thread .45" (11.4mm) long
74601-01	74601-01-BX	74601-01-BP	7A at 12V DC	1-99%	2 wires (Load & Battery) 1 25/32" (45.2mm) long	Diecast	1 9/16" Ø x .883" 39.7mm Ø x 22.4mm	7/16"-28 thread .45" (11.4mm) long
74603	74603-BX	-	6A at 12V DC	1-99%	2 wires 2" (50.8mm) long two AMP connectors (load 480054-3, battery 480053-3)	Diecast	1 9/16"Ø x .883" 39.7mm Ø x 22.4mm	7/16"-28 thread .45" (11.4mm) long
74601-06	-	-	7A at 14.7V DC	18% - 45% +/- 5%	TYCO Terminal #3-520106-2	Plated Steel	1 9/16" Ø x .883" 39.7mm Ø x 22.4mm	7/16"-28 thread .45" (11.4mm) long
74601-12	-	-	7A at 14.7V DC	-	2 Terminated Wire TE Connectivity 3-520106-2	Plated Steel	1 9/16" Ø x .883" 39.7mm Ø x 22.4mm	7/16"-28 thread .45" (11.4mm) long

Rotary Headlamp Switches

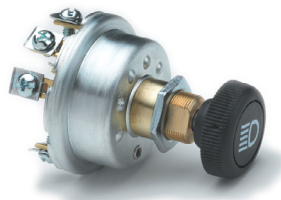

72079-01



PART NUMBERS BULK	RATING PER CIRCUIT	POSITIONS	ACTUATOR KNOB	ACTUATOR IMPRINT	TERMINALS	CONTACTS	HOUSING	MOUNTING STEM	NOTES
72079-01	20A at 12V DC	4	Black Plastic	SAE Headlight Symbol	5 screw	Silver	Plated Steel	5/8"-32 thread	O-Ring Seal in Stem

Foot Operated Switches

Foot Operated Turn Switches

Depress to On, spring return to Off. Two switches are needed for left and right turn signals. Plastic-coated, providing protection against moisture, dust and roadsplash.

Additional information: Littelfuse.com/FootSwitches



PART NUMBERS BULK	PART NUMBERS BOXED	CIRCUITRY	TYPE	NORMAL POSITION	TERMINALS	HOUSING	MOUNTING TYPE	MOUNTING HOLES	STEM SIZE	NOTES
7792	7792-BX	SPST	Off-On	Normally Off	2 screw	Diecast PVC Coated	Through-Floorboard	3x 1/4"-20 tapped holes 3/4" and 1-3/4" on centers	7/8" Ø	Sealed
7792-01	7792-01-BX		Depress to On, spring return to Off.	Normally Open	2 Screw	Diecast PVC Coated	Through-Floorboard	3x 1/4"-20 tapped holes 3/4" and 1-3/4" on centers	7/8" Ø	-
7792-03	-		On-Off	Normally Open	2 Wire Leads	Diecast PVC Coated	Through-Floorboard	3x 1/4"-20 tapped holes 3/4" and 1-3/4" on centers	7/8" Ø	-

Foot Operated Switches

Foot Operated Headlamp Dimmer Switches

Depress-release for low beam, depress-release for high beam. Corrosion-resistant diecast metal housings, moisture-repellent insulators.

Additional information: Littelfuse.com/FootSwitches

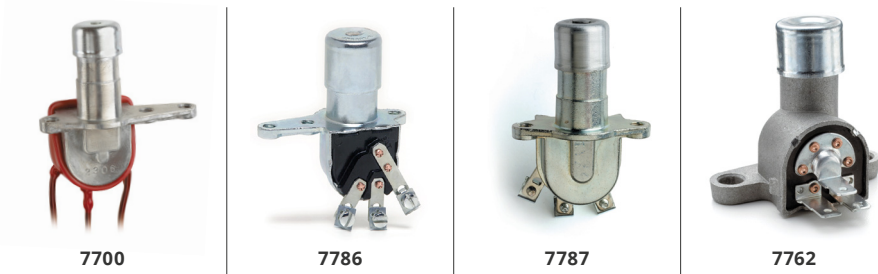

PART NUMBERS BULK	PART NUMBERS BOXED	CIRCUITRY	TYPE	TERMINALS	CONNECTOR	HOUSING	MOUNTING TYPE	MOUNTING HOLES	STEM SIZE
7700	7700-BX		On-On	3x 16 AWG (5.75" long)	-	PVC Coated Diecast	Through-Floorboard	3x 1/4"-20 tapped holes 3/4" and 1-3/4" on centers	27/32" Ø
7786	7786-BX		-	3 screw	-	Diecast		3x 1/4"-20 tapped holes 3/4" and 1-3/4" on centers	1-1/16" Ø
7784	7784-BX		On-On	3 screw	-	Diecast		3x 1/4"-20 tapped holes 3/4" and 1-3/4" on centers	7/8" Ø
7785-01	-	SPDT	On-Off	-	Packard Connector 12015792	PVC Coated Diecast		3x 1/4"-20 tapped holes 3/4" and 1-3/4" on centers	7/8" Ø
7786-01	-		On-On	-	Aptiv 12015793	PVC Coated Diecast		3x 1/4"-20 tapped holes 3/4" and 1-3/4" on centers	7/8" Ø
7786-03	-		-	3 wire leads	-	Diecast		3x 1/4"-20 tapped holes 3/4" and 1-3/4" on centers	-
7789-02	7789-02-BX		-	3 blade	-	Diecast		3x 1/4"-20 tapped holes 3/4" and 1-3/4" on centers	55/64"
7787	7787-BX		-	3 screw	-	Diecast		2x 1/4"-20 tapped holes 1-3/4" on centers	7/8" Ø
7762	7762-BX		-	3 blade	30155	Diecast	On-Floorboard	2x 9/32"Ø holes 1-3/4" on centers	-

Foot Operated Starter Switches

Off-On, normally Off. Depress to On, spring return to Off.

Additional information: Littelfuse.com/FootSwitches



PART NUMBERS BULK	PART NUMBERS BOXED	CIRCUITRY	TYPE	NORMAL POSITION	TERMINALS	MOUNTING TYPE	MOUNTING HOLES	PLUNGER	NOTES
9183	9183-BX	SPST	Off-On	Normally Off	2x 5/16"-24 studs with hexnuts & washers	Through-Floorboard	2x 9/32"Ø holes 1-3/4" on centers	1" Long	Autolite SW-4012 (15-49) Delco 1996478

Backup Switches

- See table below for replacement suitability
- Normally off, on with plunger depressed, spring return to Off

Additional information: Littelfuse.com/BackupSwitches



91113



75125

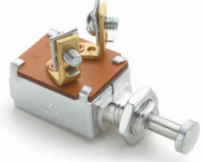

9052

PART NUMBERS BULK	PART NUMBERS BOXED	RATING	POLE & THROW	ACTION	NORMAL POSITION	ACTUATOR	MOUNTING	DETAIL	TERMINALS
91113	91113-BX	20A at 12V DC	SPST	Off-On	Normally Off	Ball	On vehicle transmission	Spring return to Off	2 screw
75125	-	-	SPST	Off-On	Normally Off	5" lever	Two 13/64" (5.2mm) Ø mounting holes, 1/2" (12.7mm) on centers	Back-up alarm switch Spring return to Off	2 screw
9052	9052-BX	10A at 12V DC	SPST	Off-On	-	Button-Head 1/2" (12.7mm) long	7/16" (7.9mm) Ø mounting stem, 7/16" -20 (7.9mm) long, with two flats for mounting in double-D hole	Spring return to Off	2 screw
91105	91105-BX	10A at 12V DC	SPST	Off-On	Normally Off	Button-head actuator, 3/8" (9.5mm) long	3/8 (9.5mm) long, 7/16 -20 (7.9mm) diameter mounting stem	On with plunger depressed, spring return to Off	2 - 18AWG Wire Leads

Stoplamp Switches

- See table below for replacement suitability
- Normally off, on with plunger depressed, spring return to Off

Additional information: Littelfuse.com/StoplampSwitches



8626



8629



8645



8715



8487

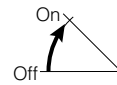

PART NUMBERS BULK	PART NUMBERS BOXED	HYDRAULIC	MECHANICAL	POLE & THROW	NORMAL POSITION	DETAIL	MOUNTING	TERMINALS	NOTES
8486	8486-BX	-	•	SPST	Normally On	-	2 - Tapped 10-32 mounting holes 5/8" on centers	2 blade	Lever actuated to Off spring return to On
8486-05	8486-05-BX	-	-		Normally Off	-	2 - Tapped 10-32 mounting holes 5/8" on centers	2 bullet	Lever actuated to On spring return to Off
8626	8626-BX	•	-		Normally Off	-	1/8" -27 thread 11/32" (8.73mm) long	2 6-32 screw	Operates at 60-120 psi (414-827 kPa); NPTF dry-seal thread for use without sealant
8629	8629-BX	•	-		Normally Off	-	1/8" -27 thread 11/32" (8.73mm) long	2 male bullet	Operates at 60-120 psi (414-827 kPa); NPTF dry-seal thread for use without sealant
8715	8715-BX	-	•		Normally On	Moisture-resistant plastic body	1/2" Ø 1 5/32" long	2 blade	Spring return to normal position.
8487	8487-BX	-	•		Normally On	Lever is 2 7/8" overall length	Tapped 10-32 mounting holes 5/8" on centers	2 bullet	Spring return to normal position.

Neutral Safety Ball Switches

- Spring return to normal position
- Moisture-resistant insulators
- Corrosion-resistant metal housings
- Silver contacts

Additional information: Littelfuse.com/NeutralSafetySwitches



PART NUMBERS BULK	PART NUMBERS BOXED	RATING	POLE & THROW	NORMAL POSITION	MOUNTING	DETAIL	TERMINALS
9242	9242-BX	35A at 12V DC 20A at 24V DC	SPST	Normally Off	9/16" -18 UNF-2A thread, 5/16" (7.9mm) long	-	2 screw
9242-01	9242-01-BX	35A at 12V DC 20A at 24V DC	SPST	Normally Off	9/16" -18 UNF-2A thread, 5/16" (7.9mm) long	Same as 9242 but with brass gasket/washer	2 screw
92107-04	92107-04-BX	20A at 12V DC	SPST	Normally Off	3/4" -16 UNF-2A thread, 31/64" (12.3mm) long	-	2 screw
9162-03	-	35A at 12V DC	SPST	Normally Off	3/4" -16 UNF-2A thread, 31/64" (12.3mm) long	Gasket on mounting stem	2 female bullet
9224	9224-BX	5A at 12V DC 3A at 24V DC	SPST	Normally On	3/4" -16 UNF-2A thread, 31/64" (12.3mm) long	Aluminum gasket/washer	2 screw

Neutral Safety and Backup Lamp Switch Accessories

For Neutral Safety and Back-up Lamp Switches. Molded of durable PVC to resist moisture and dirt. Internal ring forms a seal with the groove around the switch housing.

PART NUMBERS BULK	PART NUMBERS BOXED	DETAIL	MOUNTING
83377	83377-BX	Protective boot for switches with 1 1/8" hex housing. Part Numbers: 9224, 9242, 9242-07, 92102, 92103, 92105, 92107-04.	Internal ring forms seal with switch housing groove



Vehicle Connectors



Heavy duty sockets, plugs and assemblies that withstand the rigors of trucking in dust, dirt, rain and snow, heat and cold, yet maintain electrical continuity between tractor unit and trailer.

Best Practices for Connectors

Properly installed tractor-trailer connectors are critical to the safe performance of a rig so connectors are routinely subjected to vibration, extreme weather conditions, as well as mechanical forces. We highly recommend that a trained technician performs the installation. It is the responsibility of the end-user to take into account the mounting location and environment, conductor type, size, flexibility and other installation parameters.

Review the assembly procedure before assembly. A common error is to not slide a clamp, boot or housing onto the cable before connecting the wires. Recommended tools: screwdriver (preferably with torque limiter); soldering iron (preferably a solder pot), solder and flux; wire stripper and cutter; and ruler. Cut the cable, and strip the jacket to the recommended length. Strip the wires to the recommended length, and tin them. Maintain a tight strand bundle before tinning, so that there are no loose strands. Re-tin if necessary. This makes it easier to insert the wires into the terminal, and helps to properly position the tinned strands at the right depth.

Slide the housing, spring coil or boot over the cable. Properly insert and position the tinned conductor into each terminal. Locate the tinned portion under the terminal screw before tightening the screw. Tighten the termination screws to the appropriate torques.

Inspect the terminated connection for cut or loose strands, fragments of wire insulation between the terminal/conductor connection, bent terminals, loose or stripped terminal screws and other visible problems.

Check that the correct connections have been made, by re-checking that the conductor jacket color matches the insulator coding.

Carefully slide the insulator into the connector housing, making sure that the insulator is fully seated. Don't twist or lever the terminated conductor after it has been inserted and locked into the insulator. This may damage the terminal and put stress on the terminated connection. Finally tighten the housing screw or cable clamp.

In order to keep a plug clean when not inserted in a socket, we recommend the use of the 11750 Stor-A-Way Plug Holder.



Tractor-Trailer Connectors

12300 & 12301 • 13-Pole Connectors

The 13-pole sockets and plugs provide six additional tractor-trailer circuits within the dimensions of traditional 7-pole connectors. The connectors are adaptable to a wide variety of wiring combinations, including multiplexed circuits. 13-Pole connectors surpass SAE J560b performance standards, by conforming to interchangeability between 7-pole and 13-pole connectors. The connectors are a bright yellow so that the 13 pole configuration is easily identifiable. They are constructed of robust glass-filled plastic housings that cannot rust or corrode. The ground terminals accept up to 8AWG wire, 7 pole terminals up to 10AWG, smaller 6 pole terminals up to 14AWG.

12300, Socket

- Gasket-sealed socket door is spring-loaded and locks onto the plug.
- Rain hood extends beyond the pins to protect the interior. The 5° downward pitch drain channel inside the socket reduces water retention.
- Three mounting holes on the flange: .33" (8.4mm) diameter, 2.93" (74.6mm) on centers.
- Includes six 31784 crimp-on connectors to mate with the six smaller pole terminals.

12301, Plug

- Plug locks into the socket, utilizing the spring-loaded socket door.
- Spring-grip contacts have self-adjusting spring bands to maintain long-term uniform electrical contact with socket pins. They also feature strain relief and grommet seals to isolate the contacts from mechanical strain and provides water protection.
- Cable retainer maintains secure cable connection.
- O-ring at the plug end prevents water from reaching the contacts.
- Includes six 31784 crimp-on connectors to mate with the six smaller pole terminals.



Additional information: Littelfuse.com/VehicleConnectors

PART NUMBERS BULK	PART NUMBERS BOXED	POLES	TYPE	MATERIAL	COLOR	TERMINALS PIN TYPE	TERMINALS MATERIAL	MOUNTING HOLES	NOTES
12300	12300-BX	13	Socket	Glass-Filled Plastic	Yellow	Solid	Brass	3	Spring Loaded Door
12301	12301-BX	13	Plug	Glass-Filled Plastic	Yellow	Solid	Brass	-	O-ring in plug end

81356 • Protective Boot for 3-Bolt Flange Sockets

Protect against road splash, dirt and moisture. Fits over the back of the flange, and covers the terminal connectors. Designed for 12310 7-pole socket and 12300 13-pole socket.

PART NUMBERS BULK	PART NUMBERS BOXED	POLES	MATERIAL	MOUNTING
81356	81356-BX	7 & 13	Rubber	Fits Sockets: 12300 and 12310



Typical RV 7-Pole Wiring Color Codes

WIRE CODE	FUNCTION
White	Ground
Black	Auxiliary power/battery charge
Yellow	Auxiliary
Red	Left turn and brake lights
Green	Taillights and clearance lights
Brown	Right turn and brake lights
Blue	Electric trailer brakes

SAE Coding Convention for 7-Pole Connectors

WIRE CODE	CONDUCTOR NUMBER	LITTELFUSE TERMINAL MARKING	FUNCTION
White	1	W	Ground return to towing vehicle
Black	2	BK	Clearance, side marker, and identification lamps
Yellow	3	Y	Left turn signal and hazard lamps
Red	4	R	Stop lamps and antilock device
Green	5	G	Right turn signal and hazard lamps
Brown	6	BR	Tail and license plate lamps
Blue	7	BL	Continuous ABS power/Auxiliary

7-Pole Connector Sockets

Sockets and plugs conform to ATA, RCCC (RP-102), SAE (J560b), FMVSS-121, FIEI TTMA (RP 40-73) standards or recommendations, and are compatible with other standard (J560b) connectors.

Ground terminal accepts wires up to 8AWG, other terminals up to 10AWG. Solid brass contacts are aligned to assure proper contact and minimal voltage drop. Wiring codes are embossed on the insulator.

The door is spring-loaded and fits over a mating ridge on the socket face to minimize penetration of dirt and moisture. Housings are constructed from corrosion-resistant diecast metal or rugged glass-filled plastic. Contacts are either self-grounding or insulated.

Additional information: Littelfuse.com/VehicleConnectors



12310



12080



12080-11 - ABS



12063



12077-01

PART NUMBERS BULK	PART NUMBERS BOXED	POLES	MOUNTING HOLES	MATERIAL	COLOR	TERMINALS PIN TYPE	TERMINALS MATERIAL	DIMENSIONS MOUNTING FLANGE	DIMENSIONS THROUGH-HOLE	SPRING LOADED DOOR	NOTES
12310	12310-BX	7	3	Glass-Filled Plastic	Black	Solid	Brass	0.33" (8.4mm) Ø 2.93" (74.6mm) on centers	-	-	Gasket-Sealed with Rain Hood
-	12080-BX			Glass-Filled Plastic	Black	Solid		0.488" x 0.328" (12.4x8.3mm) oval 2.93" (74.6mm) on centers	2" (50.8mm) Ø		Insulated
-	12080-11-BX			Glass-Filled Plastic	Green	Solid		0.488" x 0.328" (12.4x8.3mm) oval 2.93" (74.6mm) on centers	2" (50.8mm) Ø		Door marked "Trailer ABS"
12063	12063-BX		2	Diecast Metal	-	Solid		0.488" x 0.328" (12.4x8.3mm) oval 2.93" (74.6mm) on centers	2" (50.8mm) Ø		Self-Grounding
12063-11	-			Diecast Metal	Silver	Solid		0.488" x 0.328" (12.4x8.3mm) oval 2.93" (74.6mm) on centers	2" (50.8mm) Ø		-
12063-01	12063-01-BX			Diecast Metal	-	Split		0.488" x 0.328" (12.4x8.3mm) oval 2.93" (74.6mm) on centers	2" (50.8mm) Ø		Self-Grounding
12077-01	12077-01-BX			Diecast Metal	-	1x Spring Grip Female 6x Solid Male		0.488" x 0.328" (12.4x8.3mm) oval 2.93" (74.6mm) on centers	2" (50.8mm) Ø		For ISO-Type Polarized ground terminal - Insulated Mates with 11100-02 and 11100-01

Note: Part Number 12077-01 - Polarized ground terminal, insulated. Replacement for ISO 3731-1976 (E) road vehicles, type 245 (supplementary).

Typical RV 7-Pole Wiring Color Codes

SAE Coding Convention for 7-Pole Connectors

WIRE CODE	FUNCTION
White	Ground
Black	Auxiliary power/battery charge
Yellow	Auxiliary
Red	Left turn and brake lights
Green	Taillights and clearance lights
Brown	Right turn and brake lights
Blue	Electric trailer brakes

WIRE CODE	CONDUCTOR NUMBER	LITTELFUSE TERMINAL MARKING	FUNCTION
White	1	W	Ground return to towing vehicle
Black	2	BK	Clearance, side marker, and identification lamps
Yellow	3	Y	Left turn signal and hazard lamps
Red	4	R	Stop lamps and antilock device
Green	5	G	Right turn signal and hazard lamps
Brown	6	BR	Tail and license plate lamps
Blue	7	BL	Continuous ABS power/Auxiliary

7-Pole Connector Plugs – High Performance

Ground terminal accepts wires up to 8AWG, other terminals up to 10AWG. Cable protectors are constructed of plated steel, and provide strain relief and protection against abrasion.

- High-Performance Plug Surpasses SAE J560b performance standards. Superior environmental protection gives extended product life. Black glass-filled plastic housing cannot rust or corrode
- Plug locks onto opening on spring-loaded socket door. Spring-grip contacts have self-adjusting spring bands to maintain long-term uniform electrical contact with socket pins. O-ring at the plug end prevents water from reaching the contacts.
- Strain relief and grommet seal isolates the contacts from mechanical strain, and provides extra moisture protection. Cable retainer maintains secure cable connection. Replaceable interior.
- Connects with all SAE J560b sockets, and Littelfuse brand 13-pole sockets.



12311

Additional information: Littelfuse.com/VehicleConnectors

PART NUMBERS BULK	PART NUMBERS BOXED	POLES	MATERIAL	COLOR	O-RING
12311	12311-BX	7	Glass-Filled Plastic	Black	•

7-Pole Connector Plugs – Quick Release Interiors

Quick Release Plug Interiors can be readily removed by loosening the single set screw in the cable clamp, and then depressing on the spring clip release with a screwdriver. The interior then readily slides out. The interior slides back into the housing and locks securely into place with a high-tension metal clip. After the cable clamp is tightened, the plug is ready for use.

- Plated steel cable protectors are available to provide strain relief and protection against abrasion
- Ground terminal accepts wires up to 8AWG, other terminals up to 10AWG.



12091 / 12092

12081 / 12082

Additional information: Littelfuse.com/VehicleConnectors

PART NUMBERS BULK	PART NUMBERS BOXED	POLES	CABLE PROTECTOR	MATERIAL	COLOR
12091	-	7	-	Diecast Metal	-
12092	12092-BX	7	•	Diecast Metal	-
12081	-	7	-	Glass-Filled Plastic	Black
12082	12082-BX	7	•	Glass-Filled Plastic	Black

7-Pole Connector Plugs – Spring Grip Electrical Contacts

Spring Grip Electrical Contacts contain a self-adjusting spring band that maintains contact pressure from socket to pin. Greater contact pressure not only gives greater electrical efficiency, but also makes coupling and uncoupling uniform, and minimizes buildup of dirt. In competitive plugs, conventional contacts tend to widen after repeated use. These plugs feature individually sprung sockets to insure maximum contact year after year.

- Plated steel cable protectors are available to provide strain relief and protection against abrasion
- Ground terminal accepts wires up to 8AWG, other terminals up to 10AWG
- Diecast metal housing
- Replaceable interior
- Wiring codes are identified on the insulator
- Cable clamp holds all wires securely

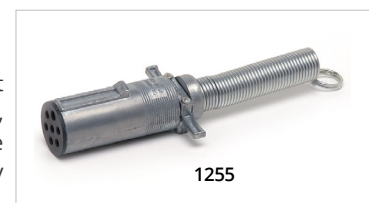

1255

Additional information: Littelfuse.com/VehicleConnectors

PART NUMBERS BULK	PART NUMBERS BOXED	POLES	CABLE PROTECTOR	MATERIAL
1222	1222-BX	7	-	Diecast Metal
1255	1255-BX	7	•	Diecast Metal

4 & 6 Pole Connector Sockets

Normally used with a trailer where limited functionality (taillights, brake lights) is needed. Ideal for boat trailers, or RVs towing a car on a flatbed trailer. Diecast metal housings. Screw terminals accept up to 12AWG wire. Replaceable interiors.

Brass split-pin contacts are aligned to assure proper contact and minimal voltage drop. Spring-loaded socket doors, plug locks securely into the opening. Wiring codes are identified on the insulator. Two mounting holes on the flange 17/64" (6.7mm) diameter, 2 15/16" (74.6mm) on centers. Mount through 1 3/8" (34.9mm) diameter hole.

Additional information: Littelfuse.com/VehicleConnectors



1258



1235



1257 / 1232

PART NUMBERS BULK	PART NUMBERS BOXED	POLES	MOUNTING HOLES	MATERIAL	TERMINALS PIN TYPE	TERMINALS MATERIAL	DIMENSIONS MOUNTING FLANGE	DIMENSIONS THROUGH-HOLE	SPRING LOADED DOOR	PROTECTIVE HOUSING	NOTES
1258	1258-BX	6	2	Diecast Metal	Split	Brass	17/67 (6.7mm) Ø 2 15/16" (74.6mm) on centers	1 3/8" Ø (34.9mm) Ø	•		Exposed terminal screws
1235	1235-BX		2	Diecast Metal	Split	Brass	17/67 (6.7mm) Ø 2 15/16" (74.6mm) on centers	1 3/8" Ø (34.9mm) Ø	•	•	-
1257	1257-BX	4	2	Diecast Metal	Split	Brass	17/67 (6.7mm) Ø 2 15/16" (74.6mm) on centers	1 3/8" Ø (34.9mm) Ø	•		Exposed terminal screws
1232	1232-BX		2	Diecast Metal	Split	Brass	17/67 (6.7mm) Ø 2 15/16" (74.6mm) on centers	1 3/8" Ø (34.9mm) Ø	•	•	-

4 & 6 Pole Connector Plugs

Contacts float for best alignment and connection. Cable clamps hold all size cables firmly in place. Cable protectors (where present) are constructed from plated steel, and provide strain relief and protection against abrasion.

Additional information: Littelfuse.com/VehicleConnectors



1236



1254



1233



1253

PART NUMBERS BULK	PART NUMBERS BOXED	POLES	CABLE PROTECTOR	MATERIAL	TERMINALS PIN TYPE	TERMINALS MATERIAL	CABLE CLAMPS	NOTES
1236	1236-BX	6	-	Diecast Metal	Split	Brass	•	Exposed terminal screws
1254	1254-BX		•	Diecast Metal	Split	Brass	•	-
1233	1233-BX	4	-	Diecast Metal	Split	Brass	•	Exposed terminal screws
1253	1253-BX		•	Diecast Metal	Split	Brass	•	-

Tractor-Trailer Connectors

2-Pole Power Take-Off Connectors

Suitable replacement for connectors in tarping applications. Provides a high-integrity two-circuit path for on- and off-road vehicles and in agricultural applications. Plug latches solidly with the socket cover.

- Vertically-aligned machined brass contacts
- Diecast zinc plug and socket housings with engineering-grade plastic interior
- Terminations accept 6AWG wire
- Polarized connections

Additional information: Littelfuse.com/VehicleConnectors



PART NUMBERS BULK	PART NUMBERS BOXED	POLES	CABLE PROTECTOR	MATERIAL	NOTES
11041-06	11041-06-BX	2	-	Diecast Metal	Gasket-sealed socket keeps out dirt and moisture when not in use
11042-05	11042-05-BX		•	Diecast Metal	Durable, flexible spring coil protects the cable

1-Pole Power Take-Off Connectors

Diecast metal plug and socket housings with engineering-grade plastic interior provides power to auxiliary equipment. Electrical conductors and connections are designed for maximum efficiency and long life and terminations accept up to 0AWG wire.

- **11041** - Socket: Self-grounding. Solid brass 3/8" (9.5mm) Ø male contact, with insulated tip to prevent short circuits. Rubber boot protects terminals and connections from moisture and dirt. Fits 2" (50.8mm) Ø hole. Two mounting holes on the flange 21/64" (8.6mm) Ø, 2 15/16" (74.6mm) on centers
- **11042** - Plug: With ground return terminal. Brass female contact with spring grip tension provides solid engagement with the mating socket. Cable clamp holds cable firmly in place.

Additional information: Littelfuse.com/VehicleConnectors



PART NUMBERS BULK	PART NUMBERS BOXED	POLES	TYPE	MATERIAL	CONTACTS
11042	11042-BX	1	Plug	Diecast Metal	Brass

Farm Equipment Connectors

Two-pole breakaway unit: plug automatically releases at approximately 20lbs pull. Mate with all connectors of comparable design. Polarized. 20A maximum capacity.

- **1282** - Socket with Mounting Bracket: Plated steel housing. High impact-resistant molded insulator. Brass contacts and brass screw terminals. Stainless steel spring on the cover locks the plug in place. Integral mounting bracket with two .218" (5.6mm) diameter mounting holes, 1.25" (31.8mm) on centers.
- **1283-325**, Plug: Plated brass housing. Threaded cable grip.

Additional information: Littelfuse.com/VehicleConnectors

PART NUMBERS BULK	PART NUMBERS BOXED	POLES	TYPE	MATERIAL	CONTACTS	TERMINALS	POLARIZED
1282	1282-BX	2	Socket	Plated Steel	Brass	Brass Screw	•
1283-325	1283-325-BX	2	Plug	Plated Brass	Brass	Brass Screw	•



In-Line Universal Connector

Flat profile design provides a robust 7-pole or 12-pole connection. Housings are molded thermoplastic material, resistant to ultraviolet solar radiation. Nickel-plated brass terminals with split contact pins give a positive connection. Insulators between each terminal provide protection from short circuits. Spring-loaded socket lid protects the terminals when not in use. Insulated cable clamp secures the cable, minimizing vibration and strain. Terminal covers are easily removed for access to terminals.

Additional information: Littelfuse.com/VehicleConnectors

Circuit Identification:

- | | | | |
|---------------------|----------------------|---|---------------|
| 1. Left turn signal | 4. Right turn signal | 7. Rear-clearance and side marker lamps | 10. Ground |
| 2. Accessory | 5. Accessory | 8. Accessory | 11. Accessory |
| 3. Ground | 6. Brake lights | 9. Accessory | 12. Accessory |



12400



12401



12500



12501

PART NUMBERS BULK	PART NUMBERS BOXED	POLES	TYPE	MATERIAL	TERMINALS	WIRE SIZE	NOTES
12400	12400-BX	7	Socket	Thermoplastic	Nickel-Plated Brass	14AWG Max	-
12401	12401-BX		Plug				-
12500	12500-BX	12	Socket	Thermoplastic	Nickel-Plated Brass	Pins 1-7: 14AWG max Pins 8-12: 8AWG max	Accepts 12- or 7-pole plug
12501	12501-BX		Plug				-

Plug & Socket Connectors with Rubber Caps

Polarized to assure proper mating of circuits. Molded insulator bodies. Precision-machined brass contacts. Rubber caps protect connectors.

Additional information: Littelfuse.com/VehicleConnectors

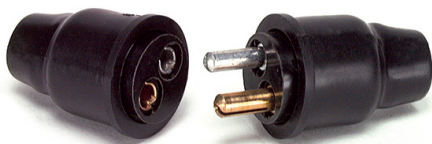

M-121 (shown without cap)

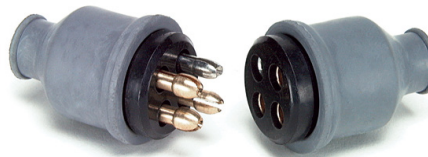

M-115

PART NUMBERS BULK	PART NUMBERS BOXED	PART NUMBERS RETAIL	POLES	TYPE	MATERIAL	CONTACTS	TERMINALS	COLOR	POLARIZED
M-121	M-121-BX	M-121-BP	2	Plug & Socket	Thermoplastic	Brass	Brass Screw	Black	•
M-115	M-115-BX	M-115-BP	4						•

Universal Trailer Connectors

Weatherproof connectors & wire lead assemblies. Polarized to assure proper mating of circuits. Molded bodies. Color-coded 16AWG wire, 6" long (152.4mm). Conductors are properly aligned and bonded into the insulation, to assure minimal voltage drop, and for ease in connecting.

Additional information: Littelfuse.com/VehicleConnectors

PART NUMBERS BULK	PART NUMBERS BOXED	PART NUMBERS RETAIL	POLES	POLARIZED
11134	11134-BX	11134-BP	4	•
11173	11173-BX	11173-BP	3	•
11172	11172-BX	11172-BP	2	•
11172-02	-	-	2	•
11172-03	-	-	2	•

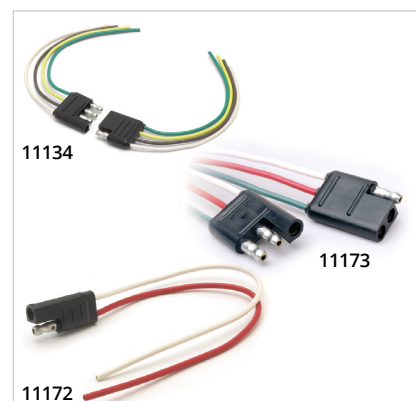

Connector Mounts & Accessories

11750 - Stor-A-Way Plug Holder

Patented by Littelfuse-Cole Hersee. Designed to keep plugs clean when not in use, and extends life by protecting electrical contacts from dirt and road splash.

For all SAE J560b 7-pole plugs and 13-pole plugs. Spring-loaded for secure locking.

PART NUMBERS BULK	PART NUMBERS BOXED	PART NUMBERS RETAIL	POLES	MATERIAL	NOTES
11750	11750-BX	11750-BP	7 or 13	Heavy duty glass-filled plastic	Fits Plugs: 12311, 1222, 1255, 12091, 12092, 12081, 12082, 12301, 11042 and 11042-05.
11750-03	-		7		



1160 - License Holder Tube

Weatherproof tube protects important papers. 5" x 1 1/8" (127.0 x 28.6mm).

PART NUMBERS BULK	MATERIAL BODY	MATERIAL CAP	MATERIAL FLANGE	MOUNTING
1160	Aluminum	Captive Brass	Brass	Three 3/16" (4.8mm) Ø mounting holes in flange



81192 - Cable Protector

Protects against strain and kinking.

PART NUMBERS BOXED	MATERIAL	NOTES
81192-BX	Plated Steel	Fits Plugs: 11042-05, 12081, 12082, 12091, 12092



11178 - Protective Boot for 7-Pole Sockets

Protect against road splash, dirt and moisture. Inner ridge locks over the heads of the terminal screws and to the edge of the casting.

PART NUMBERS BULK	PART NUMBERS BOXED	POLES	MATERIAL	NOTES
11178	11178-BX	7	Rubber	Fits Sockets: 12063, 12063-01, 12080, 12080-01, 12080-11, 12077-01 and other 7-pole sockets with similar design



Surface Mounting Socket Accessories

For attachment of 4-, 6-, and 7-pole sockets of standard design (without integral circuit breakers).

- **11165** - Mounting Bracket: Eliminates the need for cutting a hole in the trailer to accept a socket. Mounting hardware included. Center hole is 2" (50.8mm) diameter.
- **11164** - Mounting Gasket: Neoprene gasket for plastic or metal sockets.

PART NUMBERS BULK	PART NUMBERS BOXED	TYPE	MATERIAL	NOTES
11165	11165-BX	Bracket	Steel	Mounting hardware included
11164	11164-BX	Gasket	Steel	Fits Sockets: 12063, 12063-01, 12080, 12080-01



98647 - 13-Conductor Cable

Straight cable, available in 500' lengths. Conductor wires are color-coded for easy recognition. Durable insulation resists abrasion and will not crack or stiffen at -70°F (-57°C).

13 TOTAL WIRE CONDUCTOR SIZES					
PART NUMBERS 500' LENGTH	MATERIAL	ONE WIRE	ONE WIRE	FIVE WIRE	SIX WIRE
98647	100% Copper	8AWG	10AWG	12AWG	14AWG

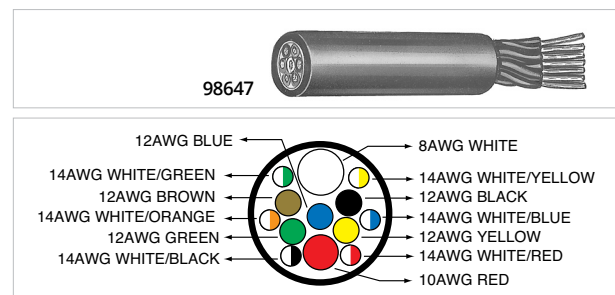

Indicator Devices

Indicators are used for remote monitoring or indication of system status. Pilot lights are frequently used as signal indicators for accessories or aftermarket add-ons.

What Are the Benefits of LEDs?

LED lights are solid-state, so they last longer and may never need servicing. This means that replacement builds are not needed, and time is saved in applications with maintenance personnel.

LEDs are unaffected by on-off cycling, and their brightness does not diminish over time. LEDs can also function over a wider range of temperatures making them ideal for harsh environments from desert conditions to frigid cold temperatures.

LEDs can be safer because they produce less heat. The build up of heat is undesirable because it can create potential fire risks. LEDs operate at a very cool temperature and the lens is not vulnerable to breakage from water-splash.

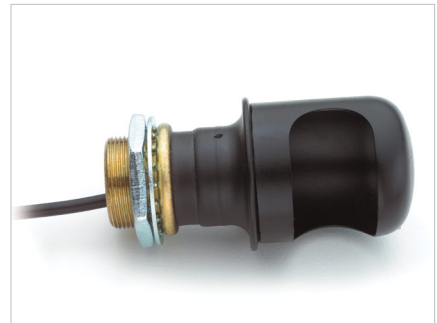

LED Pilot Lights

12V LED Pilot Lights

Rugged light-emitting diode that ensures long hours of service, never needing bulb replacement.

Additional information: Littelfuse.com/PilotLights

PL-521 Series

- Approx. 1" bezel, fits 11/16" diameter hole (17.2mm).

PART NUMBERS BULK	PART NUMBERS BOXED	RATING	COLOR	TERMINALS	BEZEL SIZE	HOLE SIZE
PL-521-RC	PL-521-RC-BX	12V DC	Red	1/4" blade	1"	11/16" Ø
PL-521-AC	PL-521-AC-BX		Amber			
PL-521-GC	PL-521-GC-BX		Green			



PL-522 Series

- Approx. 3/4" bezel, fits 5/8" diameter hole (15.9mm).

PART NUMBERS BULK	PART NUMBERS BOXED	RATING	COLOR	TERMINALS	BEZEL SIZE	HOLE SIZE
PL-522-RC	PL-522-RC-BX	12V DC	Red	1/4" blade	3/4"	5/8" Ø
PL-522-AC	PL-522-AC-BX		Amber			
PL-522-GC	PL-522-GC-BX		Green			



PL-523 Series

- Approx. 3/4" bezel, fits 5/8" diameter hole (15.9mm).

PART NUMBERS BULK	PART NUMBERS BOXED	RATING	COLOR	TERMINALS	BEZEL SIZE	HOLE SIZE
PL-523-RC	PL-523-RC-BX	12V DC	Red	1/4" blade	3/4"	5/8" Ø
PL-523-AC	PL-523-AC-BX		Amber			
PL-523-GC	PL-523-GC-BX		Green			
PL-523-BC	PL-523-BC-BX		Blue			
PL-523-CC	PL-523-CC-BX		Clear			



PL-524 Series

- Approx. 5/8" bezel, fits 1/2" diameter hole (15.9mm), 0.5 to 5.5mm thick.

PART NUMBERS BULK	PART NUMBERS BOXED	RATING	COLOR	TERMINALS	BEZEL SIZE	HOLE SIZE
PL-524-RC	PL-524-RC-BX	12V DC	Red	1/4" blade	5/8"	1/2" Ø
PL-524-AC	PL-524-AC-BX		Amber			
PL-524-GC	PL-524-GC-BX		Green			



PL-525 & PL-526 Series

- Approx. 3/8" bezel, snaps into 21/64" diameter hole (8.3mm), 0.5 to 2.0mm thick. 6-3/4" wire leads.
- PL-525 series is maintained illuminations; PL-526 series in blinking illumination.

PART NUMBERS BULK	RATING	COLOR	TERMINALS	BEZEL SIZE	HOLE SIZE	COLOR
PL-525-RC	12V DC	Red	6 3/4" wire leads	3/8"	21/64" Ø	-
PL-525-AC		Amber				-
PL-525-GC		Green				-
PL-526-RC		Red				•
PL-526-AC		Amber				•
PL-526-GC		Green				•

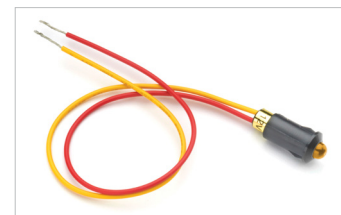

PL-612 & PL-624 Series • 12V & 24V

- 0.63" bezel diameter, fits panels 5.1 to 7.6mm thick. 1.25" (31.7mm) body length.

PART NUMBERS BULK	PART NUMBERS BOXED	PART NUMBERS RETAIL	RATING	COLOR	TERMINALS	BEZEL SIZE	BODY LENGTH
PL-612-R	PL-612-R-BX	PL-612-R-BP	12V DC	Red	1/4" blade	0.63"	1.25"
PL-612-A	PL-612-A-BX	PL-612-A-BP		Amber			
PL-612-G	PL-612-G-BX	PL-612-G-BP		Green			
PL-612-B	PL-612-B-BX	PL-612-B-BP	Blue				
PL-624-R	PL-624-R-BX	-	24V DC	Red	1/4" blade	0.63"	1.25"
PL-624-A	PL-624-A-BX	-		Amber			
PL-624-G	PL-624-G-BX	-		Green			
PL-624-B	PL-624-B-BX	-		Blue			



Incandescent Pilot Lights

12V Incandescent Pilot Lights

Corrosion-resistant construction. Spring-actuated brass contacts assure proper contact with the bulb. 16AWG (1.0mm²) insulated stranded copper leads, 8" (203mm) long.

Additional information: Littelfuse.com/PilotLights

PL-2 Series • 12V Single Contact

- #53 bulb supplied, Plated brass bezel, satin finish.
- 5/16" (7.9mm) diameter mounting stem, 3/8" (9.5mm) long.

PART NUMBERS BULK	PART NUMBERS BOXED	RATING	COLOR	TERMINALS	BEZEL SIZE	LENS SIZE
-	PL-2-RC000-BX	12V DC	Red	2x 8" wire leads	1/2" (12.7mm) Ø	3/16" (4.76mm) Ø
PL-2-GC000	PL-2-GC000-BX		Green			
PL-2-BC000	-		Blue			



PL-20 Series • 12V Single Contact

- #53 bulb supplied, Chrome-plated brass bezel.
- 3/4" (19.1mm) diameter mounting stem, 11/16" (17.5mm) long.

PART NUMBERS BULK	PART NUMBERS BOXED	RATING	COLOR	TERMINALS	BEZEL SIZE	HOLE SIZE
PL-20-RC000	PL-20-RC000-BX	12V DC	Red	2x 8" wire leads	7/8" (22.2mm) Ø	17/32" (13.5mm) Ø
PL-20-GC000	PL-20-GC000-BX		Green			
PL-20-AC000	PL-20-AC000-BX		Amber			



PL-36 Series • 12V Single Contact, Insulated with Faceted Lens

- Lenses have honeycomb pattern on the internal side, smooth on the outside.
- #53 bulb supplied, Satin finish stainless steel bezel.
- 1/2" (12.7mm) diameter mounting stem, 3/8" (9.5mm) long.

PART NUMBERS BULK	PART NUMBERS BOXED	RATING	COLOR	TERMINALS	BEZEL SIZE	HOLE SIZE
PL-36-RC000	PL-36-RC000-BX	12V DC	Red	2x 8" wire leads	3/4" (19.1mm) Ø	5/16" (8.0mm) Ø
PL-36-GC000	PL-36-GC000-BX		Green			
-	PL-36-AC000-BX		Amber			



PL-85 Series • 12V Single Contact with Faceted Lens

- #67 bulb supplied, Plated brass bezel.
- 7/8" (22.2mm) diameter mounting stem, 3/4" (19.1mm) long.
- Faceted outer lens surface.
- Gasket sealed.

PART NUMBERS BULK	PART NUMBERS BOXED	RATING	COLOR	TERMINALS	BEZEL SIZE	HOLE SIZE
PL-85-RC000	PL-85-RC000-BX	12V DC	Red	1x 8" wire leads	1 1/4" (31.8mm) Ø	15/16" (23.8mm) Ø
PL-85-GC000	PL-85-GC000-BX		Green			
PL-85-AC000	PL-85-AC000-BX		Amber			



PL-86 Series • 12V Double Contact, Insulated

- #68 bulb supplied, Plated brass bezel.
- 7/8" (22.2mm) diameter mounting stem, 3/4" (19.1mm) long.
- Gasket sealed.

PART NUMBERS BULK	PART NUMBERS BOXED	RATING	COLOR	TERMINALS	BEZEL SIZE	HOLE SIZE
PL-86-RC000	PL-86-RC000-BX	12V DC	Red	2x 8" wire leads	1 1/4" (31.8mm) Ø	15/16" (23.8mm) Ø
PL-86-GC000	PL-86-GC000-BX		Green			
PL-86-AC000	PL-86-AC000-BX		Amber			



Incandescent Pilot Lights

PL-116 Series • 12V Single Contact, Insulated Pilot Light

- #1893 bulb supplied, Aluminum bezel.
- Plastic socket.

PART NUMBERS BOXED	RATING	COLOR	TERMINALS	BEZEL SIZE	LENS SIZE
PL-116-RC000-BX	12V DC	Red	None	15/16" (23.8mm) Ø	5/8" (15.9mm) Ø



PL-118 Series • 12V Single Contact, Insulated Pilot Light

- Mounts through rear of the panel. #1893 bulb supplied. Satin finish or black aluminum bezel.
- 11/16" (7.5mm) diameter mounting stem, 1/4" (6.4mm) long.

PART NUMBERS BULK	PART NUMBERS BOXED	RATING	LENS COLOR	BEZEL COLOR	TERMINALS	BEZEL SIZE	LENS SIZE
PL-118-RC000	PL-118-RC000-BX	12V DC	Red	Satin Silver	2x 8" wire leads	15/16" (23.8mm) Ø	5/8" (15.9mm) Ø
PL-118-RC001	PL-118-RC001-BX		Red	Black			
PL-118-GC001	PL-118-GC001-BX		Green	Black			
PL-118-AC001	-		Amber	Black			



M-320 Series • 12V Single Contact, Insulated with Smooth Lens

- #53 bulb supplied, Chrome-plated brass bezel.
- Plastic socket.
- 3/4" (19.1mm) diameter mounting stem, 1 1/16" (27.0mm) long.

PART NUMBERS BOXED	RATING	COLOR	TERMINALS	BEZEL SIZE	LENS SIZE
M-320-RC000-BX	12V DC	Red	2x 8" wire leads	7/8" (22.2mm) Ø	17/32" (13.5mm) Ø



Panel Lamps and Base Sockets

12V Bayonet Base Sockets

- Accept incandescent or LED bulbs with corresponding bases.
- Suggested lamp numbers for BA15s sockets: 63, 67, 81, 87, 93, 97,103, 209,1073, 1129, 1133, 1141, 1156.
- 16AWG insulated stranded copper leads 8" (203mm) long



26145



26100



2609



3575



2611

PART NUMBERS BULK	PART NUMBERS BOXED	PART NUMBERS RETAIL	RATING	LAMPS ACCEPTED	MOUNTING	TERMINALS	CONTACT TYPE	NOTES
-	-	26100-BP	12V DC	BA15d	Without Flange	2x Wire	Double	11/16" outside diameter Molded plastic insulator
2609	2609-BX	-			Side bracket with 3/16" (4.8mm) Ø hole	1x Wire	Single	-
M-432	M-432-BX	M-432-BP			Standard Base	2 Screw	Double	Marine Socket
M-458	M-458-BX	-			Standard Base	2 Wire	Double	Marine Dash Assembly

DL Series • 12V Single Contact, Grounding Panel Lamps

- Self-grounding to metal panels.
- For illumination of maps or other items, with minimal interference of driving visibility.
- Hood can be rotated to direct the light beam.
- 11/16" (17.5mm) diameter mounting stem, 3/8" (9.5mm) long; mount through the panel.
- 16AWG insulated stranded copper leads.

PART NUMBERS BULK	PART NUMBERS BOXED	RATING	COLOR	MATERIAL	TERMINALS
DL-13	DL-13-BX	12V DC	Chrome-plated	Brass	1x 8" wire leads
DL-21	DL-21-BX		Black	Steel	



Buzzers and Alarms

4099 • 12 & 24V DC Universal Buzzer

Hundreds of uses; for ‘door ajar’ warning, bus driver alert, low air pressure, temperature, etc. Works with any temperature, pressure, door or momentary switch. Electrical contacts are designed for instant response and uninterrupted signal.

- Impact resistant ABS resin case.
- Moisture repellent insulator.

Additional information: Littelfuse.com/Alarms

PART NUMBERS BULK	PART NUMBERS BOXED	PART NUMBERS RETAIL	VOLTAGE	DIMENSIONS	TERMINALS
4099	4099-BX	4099-BP	12V DC	1 7/8" x 2 1/2" x 2 17/32" (30.9 x 63.2 x 64.3mm)	2 Screw
40151	40151-BX	-	24V DC		



40100 • Buzzer Pull Switch

For use by passengers in buses and rapid transit vehicles, the end of the switch attaches to a cord. Use with Littelfuse buzzers or buzzer/flashers: 4099, 4112 RC, 4124-RD.

SPST Off-Mom. On. Normally Off, pull to On, spring return to Off. Neutral gray enamel finish cover. Operates with a pull cord.

Additional information: Littelfuse.com/Alarms

PART NUMBERS BULK	PART NUMBERS BOXED	VOLTAGE	TERMINALS
40100	40100-BX	Up to 36V DC	2 Screw



4112-RC • 12 & 24V DC Buzzer and LED Indicator “Dual Alarm”

Rugged combination warning light and buzzer gives audible and visible alert. Device is a universal application and can be used with any electrical switch. Red lens, long-life LED. 11/16" (17.46mm) diameter mounting stem, 17/32" (13.88mm) long.

Additional information: Littelfuse.com/Alarms

PART NUMBERS BULK	PART NUMBERS BOXED	PART NUMBERS RETAIL	VOLTAGE	DIMENSIONS	TERMINALS
4112-RC	4112-RC-BX	4112-RC-BP	12V DC	1 7/8" x 1" x 1 11/32" (47.6 x 25.4 x 34.1mm)	2 Screw
4124-RD000	4124-RD000-BX	-	24V DC		

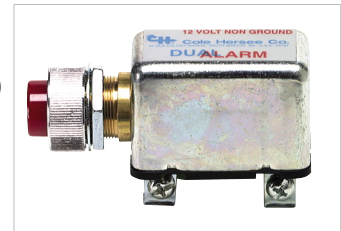

40212 • 12V DC Dual Rate Electronic Alarm

Utilizes advanced integrated circuit surface mount technology. Negative ground. Use with two input sources to warn of two different hazardous conditions. Sounds at two different rates: one sensor triggers a fast-rate alarm, the second actuates a slower rate alarm tone.

- Minimum sound level: 90dB
- Lightweight molded plastic housing.
- Solid-state circuitry.
- Plugs into Littelfuse connector 3032 or 3029, Delphi (Packard) 12033871, or accepts connectors for 1/4" (6.4mm) blades.

Additional information: Littelfuse.com/Alarms

PART NUMBERS BULK	PART NUMBERS BOXED	VOLTAGE	DIMENSIONS	TERMINALS	NOTES
40212	40212-BX	12V DC	2.005" x 1.185 x .930" (50.4 x 30.3 x 23.66mm)	1/4" Blades	Minimum sound level: 90dB

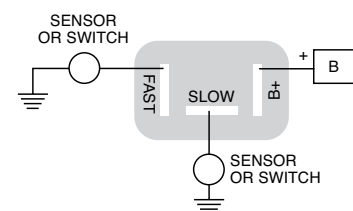

Why Are LED Lights Better For My Vehicle?

They are solid-state, so they last longer, and may never need replacing

You don't need to purchase replacement bulbs and keep a stock of them. You won't need to use the valuable time of your maintenance staff. Less downtime for your vehicles means more revenue-producing hours per vehicle. LEDs are unaffected by the on-off cycling. Their brightness doesn't diminish over time. LEDs can function over a wider range of temperatures, from desert conditions to frigid weather.

LEDs last longer because they are unaffected by vibration

Incandescent bulbs contain a small filament which is vulnerable to the shock experienced by vehicles as they travel. LEDs are solid state and don't have filaments or bulbs that can work loose.

LEDs produce less heat

LEDs are safer. A buildup of heat is undesirable since the potential exists to cause fires. LEDs run far cooler. The heated glass of conventional bulbs is vulnerable to splash – and more likely to fail prematurely.

LEDs are more efficient

Less battery drain. Up to 90% of the power used in an incandescent bulb is converted into wasted heat energy. For the amount of light emitted, LEDs draw fewer watts from your batteries. LEDs are not susceptible to the corrosion that may occur in bulb bases and sockets.



Carling Technologies is now a part of Littelfuse



Carling Technologies®
A Littelfuse® Brand

Littelfuse acquired Carling Technologies, headquartered in Plainville, CT, on November 30, 2021, to offer a more extensive portfolio of products in the commercial vehicle and aftermarket channels. Since 1920, Carling has been a leader in switching and circuit protection technologies with a strong global presence in commercial transportation, communications infrastructure and marine markets.

With over nine decades of design and original equipment manufacturing experience, Carling Technologies prides itself in developing high quality products for fast growing industries such as On-Off Highway, Marine, Renewable Energy, and Datacom/Telecom. ISO9001 and IATF16949 registered manufacturing facilities.



Resources

Switch Products Selection Guide

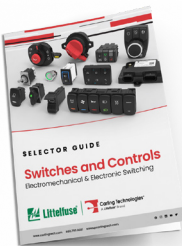

↓ DOWNLOAD

On/Off-Highway Brochure



↓ DOWNLOAD

Configure a Complete Part Number

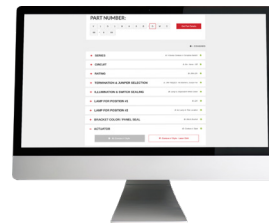

New Retail Packaged Product Offerings

Popular Carling Technologies products are available from Littelfuse

Sealed Rocker Switches

V Series Contura®

- 20A at 12V DC
- Fits Panels 0.03" - 0.25" [0.76 - 6.35mm] Thick
- 0.83" x 1.45" [21.08 x 36.83mm] Panel Cutout
- 1/4" [6.35mm] Tab Terminals
- 3 Rocker Options Included



CARDED MATERIAL NUMBER	ACTUATOR 1 DESCRIPTION	ACTUATOR 2 DESCRIPTION	ACTUATOR 3 DESCRIPTION	DESCRIPTION
CTVS001-BP	(C II) Black Actuator, 1 Red Bar Lens	(C III) White Actuator, 1 Red Bar Lens	(C V) Black Actuator, 1 Red Bar Lens	ON-OFF, SPST
CTVS002-BP	(C II) Black Actuator, Red Square & Bar Lens	(C III) White Actuator, 2 Red Bar Lens	(C V) Black Actuator, 2 Blue Oval Lens	ON-OFF, SPST
CTVS003-BP	(C II) Black Actuator, No Lens	(C III) Black Actuator, No Lens	(C V) Black Actuator, No Lens	(ON)-OFF, SPST
CTVS004-BP	(C II) Black Actuator, Red Square & Bar Lens	(C III) White Actuator, 2 Red Bar Lens	(C V) Black Actuator, 2 Blue Oval Lens	ON-OFF-ON, SPDT
CTVS005-BP	(C II) Black Actuator, No Lens	(C III) Black Actuator, No Lens	(C V) Black Actuator, No Lens	(ON)-OFF-(ON), SPDT
CTVS006-BP	(C II) Black Actuator, 1 Red Bar Lens	(C III) White Actuator, 1 Red Bar Lens	(C V) Black Actuator, 1 Red Bar Lens	ON-OFF-ON, DPDT
CTVS007-BP	(C II) Black Actuator, Red Square & Bar Lens	(C III) White Actuator, 2 Red Bar Lens	(C V) Black Actuator, 2 Blue Oval Lens	ON-OFF-ON, DPDT
CTVS008-BP	(C II) Black Actuator, Blue Square & Bar Lens	(C II) Black Actuator, White Square & Bar Lens	(C V) Black Actuator, 2 Blue Oval Lens	ON-OFF, SPST
CTVS009-BP	(C II) Black Actuator, 1 Blue Bar Lens	(C II) Black Actuator, White Square & Bar Lens	(C V) Black Actuator, 1 Blue Bar Lens	(ON)-OFF, SPST
CTVS010-BP	(C II) Black Actuator, Blue Square & Bar Lens	(C II) Black Actuator, White square & Bar Lens	(C V) Black Actuator, 2 Blue Oval Lens	ON-OFF-ON, DPDT
CTVS011-BP	(C II) Black Actuator, Red Square & Bar Lens	(C III) White Actuator, 2 Red Bar Lens	(C V) Black Actuator, 2 Red Oval Lens	ON-OFF, SPST
CTVS012-BP	(C II) Black Actuator, Red Square & Bar Lens	(C III) White Actuator, 2 Red Bar Lens	(C V) Black Actuator, 2 Red Oval Lens	ON-OFF-ON, SPDT
CTVS013-BP	(C II) Black Actuator, 1 Red Bar Lens	(C III) White Actuator, 1 Red Bar Lens	(C V) Black Actuator, 1 Red Bar Lens	ON-OFF-ON, DPDT
CTVS014-BP	(C II) Black Actuator, Red Square & Bar Lens	(C III) White Actuator, 2 Red Bar Lens	(C V) Black Actuator, 2 Red Oval Lens	ON-OFF-ON, DPDT



Rocker Switches

TIG Series Tippette®

- 15-20A at 12-28V DC
- 1/4" [6.35mm] Tab Terminals



CARDED MATERIAL NUMBER	BULK MATERIAL NUMBER	RATINGS	DESCRIPTION
CTRS001-BP	CTRS001	20A at 12-28V DC	ON-OFF-ON, SPDT
CTRS002-BP	CTRS002	20A at 12-28V DC	ON-ON, SPDT
CTRS003-BP	CTRS003	15A at 12-28V DC	ON-ON-OFF, SPDT
CTRS004-BP	CTRS004	15A at 12-28V DC	(ON)-ON-OFF, SPDT
CTRS005-BP	CTRS005	15A at 12-28V DC	ON-OFF-ON, DPDT Reversing
CTRS006-BP	CTRS006	20A at 12-28V DC	ON-OFF, DPST
CTRS007-BP	CTRS007	20A at 12-28V DC	ON-OFF, DPST



New Retail Packaged Product Offerings

Popular Carling Technologies products are available from Littelfuse

Lighted Toggle Switches

LT Series

- 15A at 12V DC
- 1/4" [6.35mm] Tab Terminals
- Nickel-Plated Toggle



CARDED MATERIAL NUMBER	BULK MATERIAL NUMBER	LAMP SEQUENCE	DESCRIPTION
CTTS001-BP	CTTS001	Red Indicator in ON Position	ON-OFF, SPST
CTTS002-BP	CTTS002	Blue Indicator in ON Position	ON-OFF, SPST
CTTS003-BP	CTTS003	Blue Indicator in ON Position	(ON)-OFF, SPST
CTTS004-BP	CTTS004	Red Indicator in ALL Positions	ON-OFF-ON, SPDT
CTTS005-BP	CTTS005	Red Indicator in ALL Positions	ON-OFF-ON, DPDT
CTTS006-BP	CTTS006	Red Indicator in ALL Positions	(ON)-OFF-(ON), DPDT



Toggle Switches

G Series, F Series, D Series

- 15A at 12-28V DC
- 1/4" [6.35mm] Tab Terminals
- Nickel-Plated Toggle



CARDED MATERIAL NUMBER	BULK MATERIAL NUMBER	CARLING SERIES	DESCRIPTION
CTTS007-BP	CTTS007	G Series	ON-OFF, DPST
CTTS008-BP	CTTS008	G Series	ON-OFF-ON, DPDT
CTTS009-BP	CTTS009	F Series	ON-OFF, SPST
CTTS010-BP	CTTS010	F Series	ON-OFF-ON, SPDT
CTTS011-BP	CTTS011	D Series	ON-OFF, SPST
CTTS012-BP	CTTS012	F Series	ON-OFF, SPST



New Retail Packaged Product Offerings

Popular Carling Technologies products are available from Littelfuse

Anti Vandal Push Button Switches

AV Series

- 10.1A Resistive, 12V DC
- 0.11" Quick Connect Tabs - Silver Plated
- M19 Threaded Bushing



CARDED MATERIAL NUMBER	BULK MATERIAL NUMBER	ILLUMINATED RING COLOR	DESCRIPTION
CTAV001-BP	CTAV001	Blue	ON-ON, SPDT
CTAV002-BP	CTAV002	Blue	ON-(ON), SPDT
CTAV003-BP	CTAV003	Red	ON-ON, SPDT
CTAV004-BP	CTAV004	Red	ON-(ON), SPDT
CTAV005-BP	CTAV005	Green	ON-ON, SPDT
CTAV006-BP	CTAV006	Green	ON-(ON), SPDT

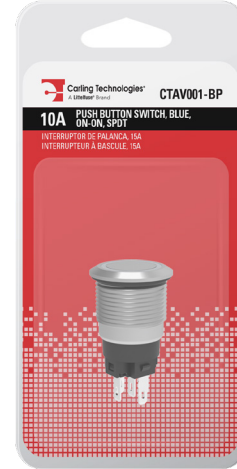

USB Charging Devices

CV Charger

- Single Port USB Charger
- Max Output: 3.6A, 18W
- Operating Voltage 9-32V DC
- 0.83" x 1.45" [21.08 x 36.83mm] Panel Cutout
- 1/4" [6.35mm] Tab Terminals
- Green Charging Indicator Light
- Spring-Loaded Access Cover Prevents Exposure While Not In Use



CARDED MATERIAL NUMBER	BULK MATERIAL NUMBER	DESCRIPTION
CTUSB001-BP	CTUSB001	Type C USB 3.1
CTUSB002-BP	CTUSB002	Type A USB 2.0

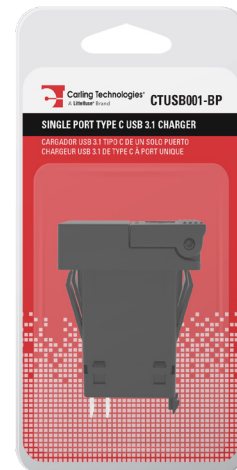

Type 3 Thermal Circuit Breakers

CMB Series

- 5-20A at 125-250V AC / 32 V DC
- 1,000 AIC at 250V AC, 2,500 AIC at 32V DC
- Push to Reset Actuator
- 3/8" Threaded Bushing
- Panel Mount



CARDED MATERIAL NUMBER	BULK MATERIAL NUMBER	AMPS
CTTB001-BP	CTTB001	5
CTTB002-BP	CTTB002	10
CTTB003-BP	CTTB003	15
CTTB004-BP	CTTB004	20

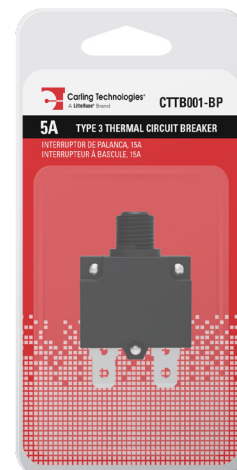

Newly Released Products

GP Series • Push Button Switch **NEW**

Pushbutton latch switch designed for in-cab installation for on- and off-highway vehicles. Featuring an internal PCB rated to 0.25A 24V DC, this 2-position, snap-in panel-mounted switch is available with ON-OFF or Momentary ON-OFF circuitry. Configurable with or without a red LED backlight, the durable polycarbonate switch can be laser-etched in red with one of several standard icons to match your application. **Additional information:** CarlingTech.com/GP



UKP Series • CAN Keypad **NEW**

The UKP-Series is a universal, customizable membrane keypad for 12V/24V systems that is compliant with SAE J1939 CAN standards. With above and below sealing protection to an IP67 rating, the UKP-Series can be installed inside or outside the cab. Each button features a laser-etched legend, up to three dimmable LED function lights, and tactile/audible feedback when pressed. **Additional information:** CarlingTech.com/UKP



CVR Series • Rheostat Switch **NEW**

Designed for vehicle lighting control, comes in three or four positions, suitable for 12V DC and 24V DC systems. Made with durable thermoplastic materials and silver-plated brass terminals, this front panel-mount dimmer switch ensures reliable operation in commercial vehicles, with optional white backlighting. The four-position circuit functions as a voltage divider, while the three-position circuit operates as a shunt resistor. **Additional information:** CarlingTech.com/CVR



L Series • Window Lift Switch **NEW**

The L-Series window lift switch from Carling Technologies, a Littelfuse Brand, is one of several available design options in the popular L-Series snap-in switch portfolio. Available for 12V DC and 24V DC systems with current ratings from 0.4 to 20 A, the new window lift switch features above-panel components that are sealed to an IP67 rating for protection against dust, debris, and water. **Additional information:** CarlingTech.com/L



EPB Series • Electronic Parking Brake Switch **NEW**

Designed for 12/24V DC systems, boasts IP54-rated sealing for above-panel components and a robust electrical endurance of 1,000,000 cycles, making it well-suited for commercial vehicles. Configurable options include parking brake only, parking brake with auto hold, or parking brake with auto hold and trailer brake functions. Additionally, users can choose between hardwired signals or SAE J1939-compliant CAN protocol configurations. **Additional information:** CarlingTech.com/EPB



Electromechanical Switches

Rocker Switches

Carling provides a diverse range of rocker switches, both illuminated and non-illuminated, with snap-in mounting. Options include 1 to 4 poles, various actuator styles, and customization for size, style, illumination, circuit, and termination. Custom colors and legends are available for most options. **Featured Products:**



Full Product Lineup: CarlingTech.com/Rocker-Switches

Electromechanical Switches

Toggle Switches

Carling's bushing mount toggle switches range from 1 to 4 poles, .4VA to 20 amps, with nylon and metal toggle styles, including illuminated toggles. Heavy-duty options and a high-temperature snap-in series are available, all certified by UL, CSA, and VDE.

Featured Products:



Full Product Lineup: CarlingTech.com/Toggle-Switches

Push Button Switches

Maintained and momentary pushbutton switches come in one to three-pole configurations, with ratings from .25 to 30 amps. Available in various nylon and metal styles with actuation force from 0.4 oz to 8 lbs. UL & CSA certified. Also, low-profile, single-pole anti-vandal pushbuttons with stainless design, illumination, QC tab terminals, and UL 1500 are offered. **Featured Products:**



Full Product Lineup: CarlingTech.com/Push-Button-Switches

Rotary Switches

UL & CSA certified rotary switches, with options like the CVR Series Rheostat for vehicle lighting control and the V Series Rotary for 12V DC and 24V DC systems. **Featured Products:**



Full Product Lineup: CarlingTech.com/Rotary-Switches

Control Switches

Variety of configurable control switches that are designed for commercial vehicles, including a lamp dimmer, mirror rotation, and wiper/washer dashboard controls. **Featured Products:**



Full Product Lineup: CarlingTech.com/Control-Switches

Digital Switches

SAE J1939 compatible digital switching products include a solid-state load controller, customizable keypads, multiplexed operator control modules, rotary encoder switch, display controller, and a CAN/LIN multiplexed switching system. Multiplexing is made easy by the use of rear-mounted Deutsch® connectors, eliminating the extra weight and cost of traditional wire harnesses. **Featured Products:**

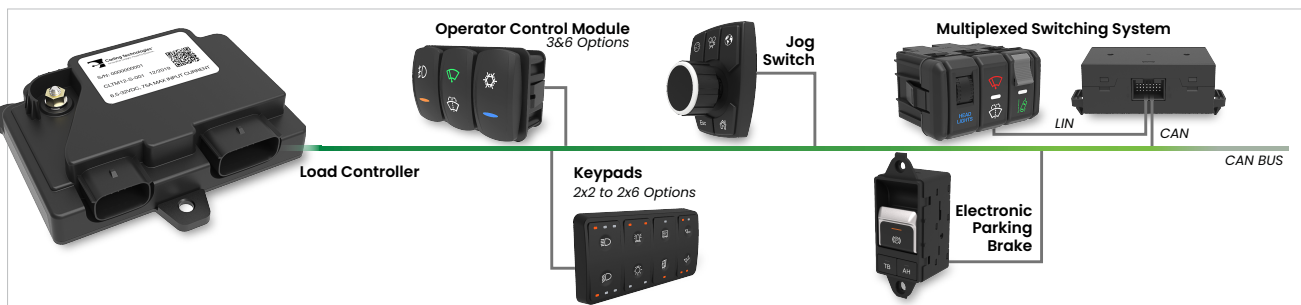

Full Product Lineup: CarlingTech.com/Digital-Switching

Appendix

Alphanumeric Part Number Index

Use index as a quick resource to find the page number of a specific part you are looking for.

Cole Hersee Packaging

Retail packaging products are designated by the **BP** and **BX** suffixes.



BX and **BP** suffixes are not individually listed, but represented by their bulk part number.

Example:

Retail packaging toggle switch 5558-BP will be listed as 5558

5 5 5 8 - B P
 "Bulk Part Number" "Blister Pack"

Littelfuse Packaging

Order numbers must have between 9 characters and 15 characters.

0 A T 0 0 1 0 . V P
 First set of four "ATO Fuses" Second set of four "10 Amps:" "Retail pack of 5"

0 M I N 0 3 0 . Z X P R O
 First set of four "MINI Fuses" Second set of four "30 Amps:" "Professional Pack"



NOTE:

Products with the amperage used in their part number are not individually listed.

Example:

10 Amp ATO Fuse, 0ATO010.VP = 0ATO0xx.VP

Inner Pack Codes - Quantity Code

1 = X	50 = L	500 = U	3,000 = W
5 = V	100 = H	1,000 = M	4,000 = Y
10 = T	200 = F	1,500 = D	5,000 = N
20 = S	250 = G	2,500 = E	10,000 = K

Application Guide

Commercial and Fleet Vehicles

Littelfuse products help protect, control and, distribute vehicle electrical power. Our Applications Guide showcases a variety of Littelfuse and Cole Hersee products for commercial and fleet vehicles in operation today.

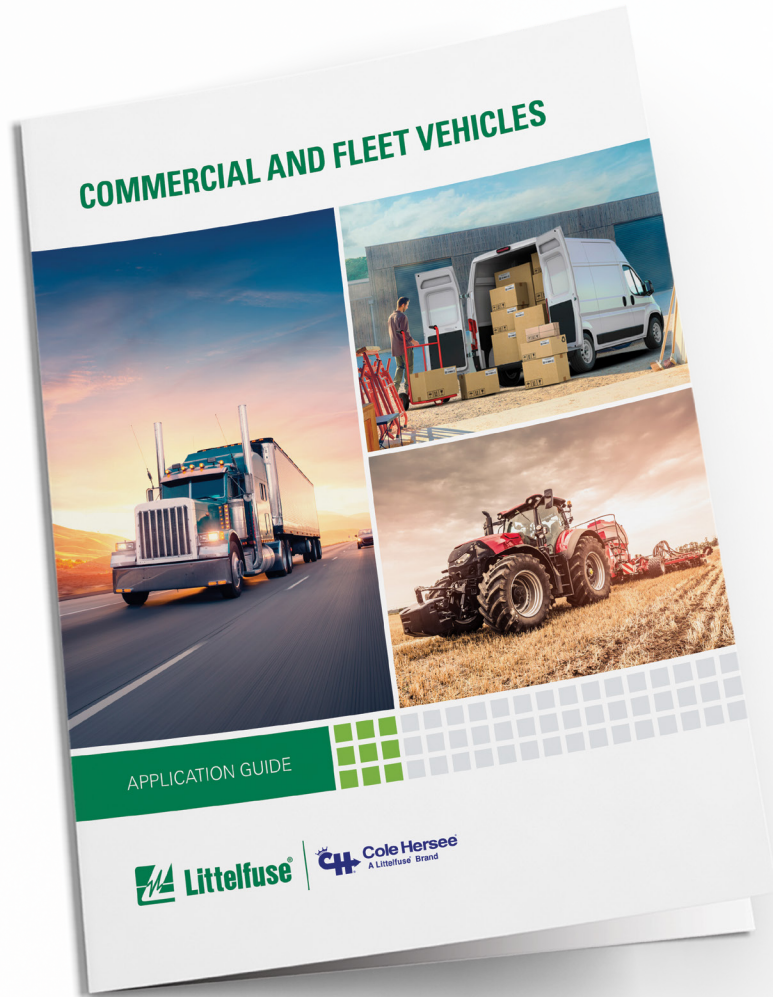

↓ SCAN TO DOWNLOAD

TRACTOR TRAILER



Circuit Protection

02981028HXFC-SS
MEGA® Flex
32V 500A Bolt-Down Fuse
Holder



FHAS100
Sealed In-Line ATO®
Waterproof Fuse Holder



880027
ST ATO® Series
6-Way Fuse Block with
Ground Bus



880089
LX Series
350A ATO® & MIDI®
Power Distribution Module



04980933.X
MDB Series
3 Way Loaded Sealed MIDI®
Fuse Holder



MINI® FUSES
2A - 30A



ATO® FUSES
1A - 40A



MEGA® FUSES
80A - 500A



MIDI® FUSES
30A - 200A



0UCB030.XP
UCB Series
30A CBK Universal
Circuit Breaker



30055-30
12V 30A Type 1
Boxed Style Circuit Breaker



Battery Power Control

880086
HD Series
Relay 24 V DC



Primary Power Distribution

FLEC3000Z-0U
FLECTM Series
Flexible Electrical Center
Configurable PDM



Circuit Protection

PDM71003ZXM
HWB60_AL
60 Way Fuse Holder



Relays & Solenoids

24059
Single Pole Series
12V Continuous Duty
Solenoid



Battery & Master Disconnect Switches

75920
75920 Series
12V 300A Master Battery
Disconnect Switch



Switches

95060
95060 Series
Ignition Switch



In-Line Fuse Holders

0FHM0002XP
MINI® FHM Series
58V 30A MINI® In-Line
Waterproof Fuse Holder



Applications

- Alarms
- Mobile Data Center
- 12V USB chargers
- Utility Lights
- Refrigeration
- Television
- Stereo & Amplifier
- CB Radio
- Microwave

Local Resources for a Global Market

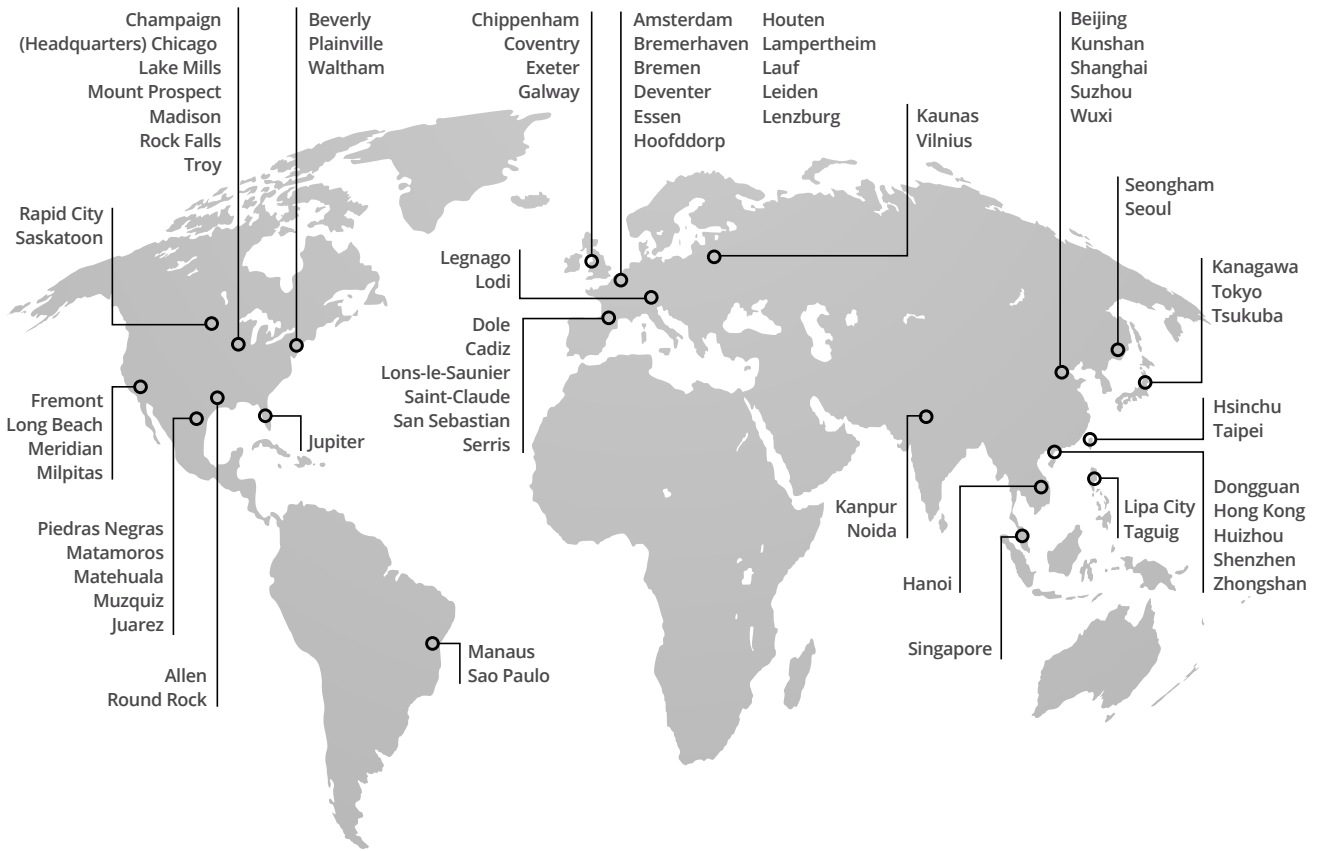

For general inquiries and information:

Littelfuse, Inc.
 8755 West Higgins Road, Suite 500
 Chicago, IL 60631, USA
 +1 773 628 1000

Littelfuse products are certified to many standards around the world. To check certifications on specific products, please refer to the product datasheet on Littelfuse.com



Product Information and Resources

Available at: littelfuse.com/CVP

Littelfuse publishes technical documents to help in the design and selection of products for electrical systems. To learn more about a specific product or application, visit our online library at:

Littelfuse.com/Commercial-Vehicle-Technical-Center

- Extended Datasheets
- Application Notes
- CAD Drawings
- 2D Outlines
- 3D Models
- Glossary
- FAQ

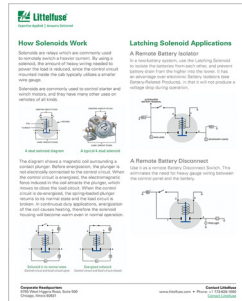

Littelfuse.com/Catalogs

Littelfuse offers digital and printed catalogs and other product brochures. To request a copy, please contact Littelfuse or download the digital version on our website.

Our product catalogs feature circuit protection, power control and sensing products for OEM and aftermarket applications.

Littelfuse.com/ContactUs

Contact Littelfuse support or find a local representative or distributor.

