



talemagroup

- Standard & Open Power Transformers 15VA - 1000VA •
- Encapsulated Toroidal Transformers 15VA - 500VA •
- Toroidal Transformers (12V Halogen Lamps) - 15VA-500VA •
- Toroidal Power Transformers (DIN Rail) - 12VA - 800VA •
- Special Mounting Power Transformers 5VA - 7.5KVA •
- Standard Mini Toroidal Transformers 1.6VA - 50VA •
- Medical Grade Isolation Transformers 50VA - 3000VA •
- Encapsulated PC Transformers 1.6VA-50VA & 35VA-160VA •

SECTION 1

Toroidal Transformers for Universal Application



Toroidal Transformers for Universal Application

TALEMA PROFILE

Founded in 1975, The TALEMA International Group has established itself as a world leader in the Design & Manufacture of toroidal transformers and related magnetic components. Our strong technical engineering expertise has contributed to the growth of our current workforce to over 800 employees in manufacturing locations in the Czech Republic and India.

Over the years The Talema Group has succeeded in designing, producing and delivering in excess of 50 million transformers to its customers. The recent incorporation of xDSL technology into our extensive range of Telecom and LAN magnetics offerings, such as ISDN, Ethernet transformers for 10/100/1000Base-T, has broadened our market offering to an even higher level.

QUALITY

The TALEMA Group has a total commitment to quality and employs Lean Six Sigma training for engineering, production and administrative staff to help achieve a goal of zero defects. All facilities maintain very stringent Quality Control and Quality Assurance procedures and are certified to and manufacture in accordance with ISO 9001:2015 (India) and ISO 9001:2016 (Czech Republic) and meet a broad range of International Standards including UL, VDE, IEC and EN.

ENVIRONMENT

All TALEMA International Group manufacturing facilities are RoHS & REACH Compliant and all chokes, inductors and HF Components are produced in an Environment Management System (EMS) facility certified to ISO 14001:2015 (India) and ISO 14001:2016 (Czech Republic).



CONTENTS

Page Nr.

• Standard Open & Encapsulated Toroidal Transformers - 0015P1-2-xxx - 1000P1-2-xxx (15VA - 1000 VA)	- 7-9
• Toroidal Transformer with Dual Secondary Winding - 55xxx Series	- 10-11
• Toroidal Transformer (12V Halogen Lamps) - 56xxx Series	- 12
• Toroidal Power Transformer - 58-xxxx-xxx-X Series	- 13-14
• Toroidal Lighting Power Transformer - 91xxx Series	- 15
• Special Transformers (Power: 5VA - 7500VA / phase)	- 16
• Standard Miniature Toroidal Transformers - 60xxx, 61xxx & 62xxx Series	- 17-19
• Medical Grade Isolation Transformers - MD Series	- 20-21
• Toroidal PC Transformers - 700xx & 72xxx Series (1.6VA - 50VA)	- 22-23
• Toroidal PC Transformers - 64xxK & 65xxK Series (35VA - 160VA)	- 24-25
• Notes	- 26
• Regional Locations - Design, Manufacturing, Sales & Marketing	- 27
• TALEMA Product Summary (Total Program)	- 28

Visit our website for detailed electrical and mechanical specifications for Talema's extensive line of magnetic components for Power Conversion, Telecom & LAN Applications:

www.talema.com

Toroidal Transformers for Universal Application

Application

TALEMA Toroidal Transformers meet modern day requirements for a small size, low magnetic interference field transformer. Featuring an ideal physical construction, design engineer can expect outstanding and excellent Performance. Small size and weight (approx. 50% of the conventional transformers), extremely low noise and low magnetic interference field make the toroidal transformer ideal for compact power supplies. Modern production techniques make it possible to produce toroidal transformers at practically the same prices as conventional transformers making them ideal for a wide range of applications including:

- Professional audio equipment
- Computers and peripherals
- Video monitors
- Motor controls
- Compact power supplies
- Medical equipment
- Instrumentation
- Office machines
- Industrial control equipment
- Low voltage lighting

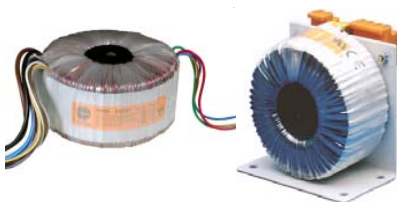

Volume and weight

The toroidal core has the optimal shape for producing a transformer with the minimum of material. Because the quality of the core is such a vital consideration for sensitive applications, TALEMA has invested heavily to provide extensive core manufacturing, annealing and testing facilities.

All windings are symmetrically spread over the entire core which makes the wire length very short. A higher flux density is possible as the magnetic flux is in the same direction as the rolling direction of the grain orientated core allowing significant savings of volume and weight. A higher current density can flow through the wire as the whole surface of the toroidal core allows efficient cooling of the copper windings.

The iron losses of the toroidal core are very small, typically 1.1W/kg at 1.7 Tesla and 50Hz, giving very small magnetizing current, which contributes to the excellent temperature rating of the toroidal transformer.

Efficiency

The toroidal shape gives a significantly higher efficiency compared to conventional transformers of the same size. The advantage is either an increased output power with the same size or a lower weight and smaller size at the same output power.



Transformer hum

Because there are no air gaps, there are no loose sheets which can vibrate. In addition, the high quality of the grain orientated silicone alloyed electric steel makes the magnetostriction very low, thus allowing the disturbing hum found in most common types of transformers to be almost completely eliminated.

Mounting Details

For sizes up to 1000VA, a low cost assembly can be made with a centering washer and a center screw or bolt. Transformers in the range of 15VA through 500VA can also be potted in standard Polyamid housings. All transformers can also be center potted either with a center hole or with a threaded insert



Production program

Standard Distribution:

Open wound, Standard and Mini; Encapsulated; Print & DIN Rail Transformers - 230V primary, with ENEC KEMA-KEUR marking

Customer standards:

Open wound, Encapsulated, Print, DIN Rail, a wide range of secondary voltages and mounting styles

Specials:

As per customer specification

- Power: 1.6VA - 7.5KVA per Phase
- Special Sizes; extremely flat or small diameter, i.e., upto 250VA with 96mm O.D for European P.C formats
- Electrostatic copper shielding
- Operating frequencies up to 20KHz
- Assembled 3 phase sets
- Magnetic shielding
- Potting in special housings for sizes upto 1.2KVA
- Secondary voltage available upto 1KV

Toroidal Transformers for Universal Application

Internationally Recognized Quality Systems and Regulatory Approvals

Factory / Process Approvals

ISO9001 approved quality systems ensure all our internal processes, from Design and development, to processing the incoming purchase orders, through Resource Planning, Scheduling and Production, right through to the delivery of the finished products run smoothly and efficiently.

Talema Electronic (India) Pvt. Ltd.,

ISO 9001:2015, Cert. No. 99 100 13735

ISO 14001:2015, Cert. No. 99 104 00381

NT Magnetics s.r.o.,

ISO 9001:2016, Cert. No. 09.186.461, revision No.1

ISO 14001:2016, Cert. No. 09.186.469, revision No.1

OHSAS 18001:2008, Cert. No. 09.186.482

Safety Agency Approvals

Talema has numerous approvals covering a wide variety of international standards and including both standard products and custom designed parts. By working closely with equipment designers and international test houses, Talema's engineering teams can assist in ensuring swift and smooth approval of equipment using its transformers and inductors.

Family Recognitions

Talema has invested considerable time and effort to obtain "family approvals" enabling automatic recognition of custom transformers without having to send each new design to a certified test facility for approval, saving the customer both time and money. UL Recognized components, DEKRA Approvals to European Standards, and IEC CB Certificates for worldwide approvals.

UL Approvals

Underwriters Laboratories : Recognised Components

Nuvotem Talema offer UL recognised components to several UL Standards. Our factories are audited regularly to ensure compliance. Our UL "Follow Up Services" or "FUS" is our detailed agreement with Underwriters Laboratories which ensures our products meet the relevant standards.

XPTQ2.E215495 Vol.1

UL5085 Low Voltage Transformers
Categories XPTQ2 & XPTQ8 (Canada)
Toroidal Isolating Transformers to 7500VA (7.5kVA)
Toroidal Auto-Transformers to 25000VA (25kVA)
Input 100V to 600V
Output Max 600V, Max 100A
Temperature Class 105(A), Class 130(B), Class 155(F)

XPTQ2.E215495 Vol.2

UL5085 Low Voltage Transformers
Categories XPTQ2 & XPTQ8 (Canada)
PCB Mounting Toroidal Transformers
Series 70000K, 1.6VA to 25VA

XORU2.E218027 Vol.1

UL62368-1 Audio/video, information and communication technology equipment
PCB Mounting Transformers 70000K series and 72400K Series

XORU2.E251176

UL60601-1 Medical Grade Transformers
Categories XORU2 & XOUR8 (Canada)
Toroidal Isolating Transformers to 15,000VA (15kVA)
Toroidal Auto-Transformers to 40,000VA (40kVA)
Maximum 600V Input and output
Maximum 1200V sum of input & Output voltages.
Temperature Class 105(A), Class 130(B), Class 155(F)

UL Recognised: UL Standard UL60601-1 1st Edition dated April 25th 2003; and ANSI/AAMI ES60601-1 (2005 + C1:09 + A2:10

C-UL Recognised: Canadian Standard C22.2 No 601.1 M90; and CSA C22.2 NO. 60601-1 (2008)

OBJY2.E217412

UL1446 Systems of Insulating Materials

Vol.1 Class 130(B) "Class B"
Vol.2 Class 130(B) "Class B1"
Vol.3 Class 155(F) "Class F"
Vol.4 Class 155(F) "Class F (Z200G)"
Vol.5 Class 130(B) "HIS-8B"

These insulation systems may be used alone, or together with our transformer approvals **E215495** or **E251176** to provide transformers with UL recognition to those standards, but with higher temperature classes.



Toroidal Transformers for Universal Application

IEC & European Approvals

Nuvotem Talema have a family approval file with DEKRA for Toroidal Power Transformers to EN61558. This is more than simply a range of standard parts with approvals. Our agreement with DEKRA allows us to design and build custom toroidal transformers which are instantly approved, without any additional testing required.

The same family is approved to IEC61558 under the IECEE CB Scheme
This "family" divided into ISOLATING and SAFETY-ISOLATING transformers.

DEKRA Approved to EN61558

Certificate 2161054.01

SAFETY Isolating Transformers

EN61558-1:2005 +A1:2009

EN61558-2-6:2009

Up to 6 primary windings

Up to 10 Secondary windings

Maximum total power rating: 3000VA

Maximum Input voltage : 440V

Maximum Output voltage : 50V (SELV Limit)

Either internal or external Overload Protection

Certificate 2161054.02

Isolating Transformers

EN61558-1:2005 +A1:2009

EN61558-2-4:2009

Up to 6 primary windings

Up to 10 Secondary windings

Maximum total power rating: 3000VA

Maximum Input voltage : 440V

Maximum Output voltage : 250V

External Overload Protection

IEC Approved to IEC61558 & IEC62368-1

IEC NL-27214

SAFETY Isolating Transformers

IEC 61558-1(ed2);am1

IEC 61558-2-6(ed2)

Maximum total power rating: 3000VA

Maximum Input voltage : 440V

Maximum Output voltage : 50V (SELV Limit)

IEC NL-27215

Isolating Transformers

IEC 61558-1(ed2);am1

IEC 61558-2-4(ed2)

Maximum total power rating: 3000VA

Maximum Input voltage : 440V

Maximum Output voltage : 250V

IEC DK-88131-UL

Audio/video, information and communication technology equipment

IEC 62368-1

7000K Series and 7240K series of PCB Mounting transformers 1.6VA to 50VA



Toroidal Transformers for Universal Application

In-rush Current

Due to lack of air gaps, toroidal transformers generally have a higher inrush current than normal transformers. For mains fuses we recommend the use of slow blowing types, especially for output power rates in excess of 500VA.

Frequency Range

TALEMA Standard Transformers are designed for operating frequencies between 48 Hz and 60Hz and operate up to 450 Hz maximum. With increasing frequency, the transformer size decreases accordingly. Core materials for frequencies up to 100kHz are available in materials such as thin tape wound nickel alloy, molded powder or sintered ferrite.

Auto-Transformers

An autotransformer allows smaller dimensions and a more economical overall design in cases where galvanically separated windings are not required

Graph 1 (Autotransformers)

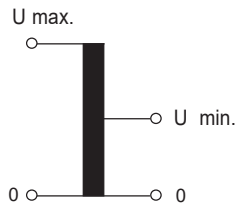

$$\text{Transf. power rating} = P_{\text{out}} \times \frac{U_{\text{max.}} - U_{\text{min.}}}{U_{\text{max.}}} \text{ [VA]}$$

$$P_{\text{out}} = \text{Output Power [VA]}$$

$$\text{Optimal Size} = \frac{U_{\text{min.}}}{U_{\text{max.}}} < 0.5$$

Voltage Drop

The secondary voltages and currents are given for normal output power. At partial load the output voltage, as a function of transformer size, will be accordingly higher. Graph 2 shows the % voltage increase for TALEMA Standard Toroidal Transformers at partial loads.

Graph 2 (Voltage Drop)

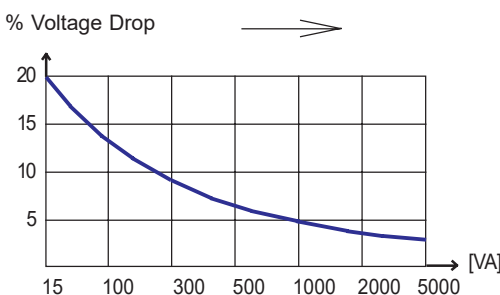

Duty Cycle

A smaller transformer can be used if the load is intermittent. Because the output power in this case significantly exceeds the nominal power, the secondary voltage drops below the voltages given. The voltage drop increases proportionately with the current being drawn.

Graph 3 (Duty Cycle)

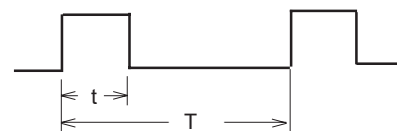

$$P_{\text{nom}} \leq P_{\text{load}} \sqrt{\frac{t}{T}}$$

Temperature rise

As can be seen from graphs 5 and 6, TALEMA Standard Toroidal Transformers are designed for a temperature rise of 60°C to 70°C at nominal load. When choosing a transformer size, the ambient temperature and heat sink coefficient of the mounting place must be taken into consideration. Graphs 5 & 6 show the typical temperature change which occurs as a function of output power or overload.

Graph 5 (Ambient Temperature)

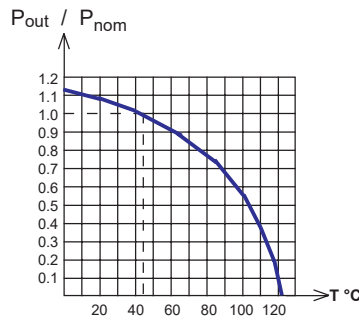

Efficiency

Graph 4 shows typical efficiency which can be expected as a function of the power relationship $P_{\text{out}} / P_{\text{nom}}$ and transformer size.

Graph 4 (Efficiency)

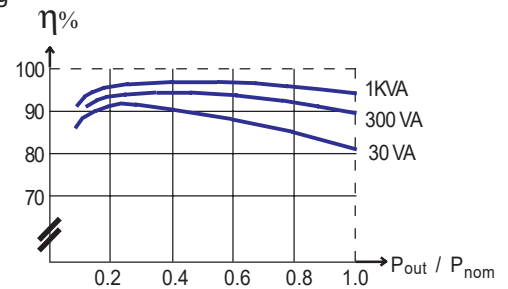

Graph 6 (Temperature Rise)

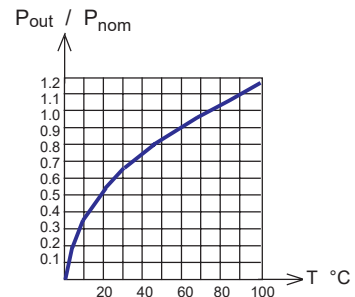

Rectifying

Graphs 7 and 8 give formulas for calculation of approximate values of the transformers and are primarily dependent on the size of the loading capacitor to be used. The applied form factor "F" is rated between 1.1 for smaller capacitors and up to 2.5 for relatively large

Graph 7 (Rectifying)

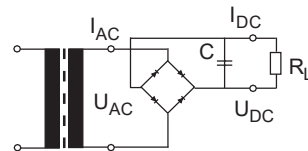

$$U_{\text{AC}} \approx \frac{U_{\text{DC}}}{\sqrt{2}} + 2 [V_{\text{eff}}] \quad I \text{ [A]} \\ t \cdot I \text{ [Sec}^{-1}] \\ C \text{ [F]}$$

$$I_{\text{AC}} \approx F \cdot I_{\text{DC}} \text{ [A]}$$

$$\text{ripple } \Delta U \approx \frac{I \cdot t}{C}$$

$$t \text{ Bridge} = 1 / 100 \text{ at } 50 \text{ Hz} \\ t \text{ Bridge} = 1 / 120 \text{ at } 60 \text{ cycles}$$

Graph 8 (Rectifying)

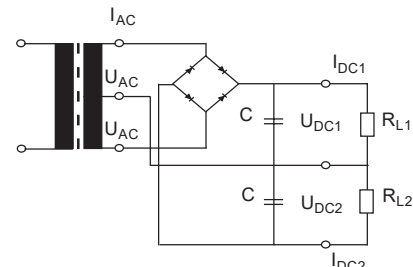

$$U_{\text{AC}} \approx \frac{U_{\text{DC}}}{\sqrt{2}} + 1 [V_{\text{eff}}]$$

$$I_{\text{AC}} \approx \frac{F \sqrt{I_{\text{DC1}}^2 + I_{\text{DC2}}^2} \text{ [A]}}{\sqrt{2}}$$

Standard Open & Encapsulated Toroidal Transformers

Features

- Single 230V & Dual 2x115V, 50/60Hz Primary
- Lower Strayfield and high efficiency
- Small size and low weight
- Extremely low level of radiated magnetic field
- Very low induced noise (hum)
- Very low iron loss
- Supplied with mounting kit
- Test Voltage Primary - Secondary 4.5 KV
- 100% electrical and flash tested
- Manufactured in an ISO 9001:2015 and ISO 14001:2015 certified Talema facility
- Fully RoHS & REACH Compliant



Power VA	Part Number	Secondary		
	Primary 230V	Full Load V	Current A	Open Circuit V
15	0015P1-2-006	2 x 6	1.25	2 x 7.0
	0015P1-2-009	2 x 9	0.83	2 x 10.5
	0015P1-2-012	2 x 12	0.63	2 x 14.0
	0015P1-2-015	2 x 15	0.50	2 x 17.4
	0015P1-2-018	2 x 18	0.42	2 x 21.1
30	0030P1-2-006	2 x 6	2.50	2 x 7.2
	0030P1-2-009	2 x 9	1.67	2 x 10.6
	0030P1-2-012	2 x 12	1.25	2 x 14.1
	0030P1-2-015	2 x 15	1.00	2 x 17.6
	0030P1-2-018	2 x 18	0.83	2 x 21.2
	0030P1-2-022	2 x 22	0.68	2 x 26.0
50	0050P1-2-006	2 x 6	4.17	2 x 6.8
	0050P1-2-009	2 x 9	2.78	2 x 10.2
	0050P1-2-012	2 x 12	2.08	2 x 13.6
	0050P1-2-015	2 x 15	1.67	2 x 17.1
	0050P1-2-018	2 x 18	1.39	2 x 20.4
	0050P1-2-022	2 x 22	1.14	2 x 24.9
80	0050P1-2-055	2 x 55	0.45	2 x 62.4
	0080P1-2-010	2 x 10	4.00	2 x 11.5
	0080P1-2-012	2 x 12	3.33	2 x 13.8
	0080P1-2-015	2 x 15	2.67	2 x 17.3
	0080P1-2-018	2 x 18	2.22	2 x 20.7
120	0080P1-2-022	2 x 22	1.82	2 x 25.4
	0120P1-2-012	2 x 12	5.00	2 x 13.4
	0120P1-2-015	2 x 15	4.00	2 x 16.8
	0120P1-2-018	2 x 18	3.33	2 x 20.2
	0120P1-2-022	2 x 22	2.73	2 x 24.5
	0120P1-2-055	2 x 55	1.03	2 x 61.3

Power VA	Part Number	Secondary		
	Primary 230V	Full Load V	Current A	Open Circuit V
160	0160P1-2-012	2 x 12	6.67	2 x 13.5
	0160P1-2-015	2 x 15	5.33	2 x 16.6
	0160P1-2-018	2 x 18	4.44	2 x 20.0
	0160P1-2-022	2 x 22	3.64	2 x 24.5
	0160P1-2-030	2 x 30	2.67	2 x 33.5
	0160P1-2-055	2 x 55	1.45	2 x 61.2
225	0225P1-2-012	2 x 12	9.38	2 x 13.1
	0225P1-2-015	2 x 15	7.50	2 x 16.5
	0225P1-2-018	2 x 18	6.25	2 x 19.7
	0225P1-2-022	2 x 22	5.11	2 x 24.2
	0225P1-2-024	2 x 24	4.69	2 x 26.5
	0225P1-2-030	2 x 30	3.75	2 x 32.8
300	0300P1-2-012	2 x 12	12.5	2 x 13.1
	0300P1-2-018	2 x 18	8.33	2 x 19.4
	0300P1-2-022	2 x 22	6.82	2 x 23.8
	0300P1-2-025	2 x 25	6.00	2 x 27.1
	0300P1-2-030	2 x 30	5.00	2 x 32.5
	0300P1-2-035	2 x 35	4.29	2 x 37.8
	0300P1-2-055	2 x 55	2.73	2 x 59.6
500	0500P1-2-020	2 x 20	12.5	2 x 21.5
	0500P1-2-025	2 x 25	10.0	2 x 26.7
	0500P1-2-030	2 x 30	8.33	2 x 32.3
	0500P1-2-040	2 x 40	6.25	2 x 43.0
	0500P1-2-055	2 x 55	4.55	2 x 59.0
625	0625P1-2-018	2 x 18	17.4	2 x 19.3
	0625P1-2-022	2 x 22	14.2	2 x 23.5
	0625P1-2-040	2 x 40	7.81	2 x 42.8
	0625P1-2-045	2 x 45	6.94	2 x 48.3
	0625P1-2-050	2 x 50	6.25	2 x 53.8
	0625P1-2-055	2 x 55	5.68	2 x 58.9
	0625P1-4-012	4 x 12	13.00	4 x 12.9
800	0800P1-2-040	2 x 40	10.00	2 x 42.4
	0800P1-2-045	2 x 45	8.89	2 x 47.6
	0800P1-2-050	2 x 50	8.00	2 x 52.9
	0800P1-2-055	2 x 55	7.27	2 x 58.1
1000	1000P1-2-018	2 x 18	27.8	2 x 18.8
	1000P1-2-018	2 x 18	27.8	2 x 18.8
	1000P1-2-022	2 x 22	22.7	2 x 23.5
	1000P1-2-040	2 x 40	12.5	2 x 42.2
	1000P1-2-045	2 x 45	11.1	2 x 47.5
	1000P1-2-050	2 x 50	10.0	2 x 52.8
	1000P1-2-055	2 x 55	9.09	2 x 58.1
	1000P1-4-022	4 x 22	11.4	4 x 23.5
	1000P1-4-028	4 x 28	8.93	4 x 29.3

Note:

Standard Encapsulated versions available from 15VA to 500VA
See following page for dimensions and specifications

Ordering Information

Example: 0030 P1 -2 -012 -K

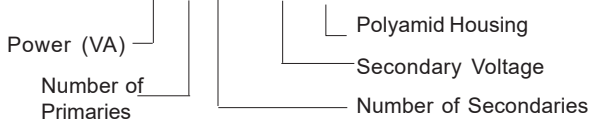

Standard Open & Encapsulated Toroidal Transformers

Power VA	Part Number	Secondary		
	Primary 2x115V	Full Load V	Current A	Open Circuit V
15	0015P2-2-006	2 x 6	1.25	2 x 7.0
	0015P2-2-009	2 x 9	0.83	2 x 10.5
	0015P2-2-012	2 x 12	0.63	2 x 14.0
	0015P2-2-015	2 x 15	0.50	2 x 17.4
	0015P2-2-018	2 x 18	0.42	2 x 21.1
	30	0030P2-2-006	2 x 6	2.50
0030P2-2-009		2 x 9	1.67	2 x 10.6
0030P2-2-012		2 x 12	1.25	2 x 14.1
0030P2-2-015		2 x 15	1.00	2 x 17.6
0030P2-2-018		2 x 18	0.83	2 x 21.2
0030P2-2-022		2 x 22	0.68	2 x 26.0
50	0050P2-2-006	2 x 6	4.17	2 x 6.8
	0050P2-2-009	2 x 9	2.78	2 x 10.2
	0050P2-2-012	2 x 12	2.08	2 x 13.6
	0050P2-2-015	2 x 15	1.67	2 x 17.1
	0050P2-2-018	2 x 18	1.39	2 x 20.4
	0050P1-2-022	2 x 22	1.14	2 x 24.9
	0050P2-2-055	2 x 55	0.45	2 x 62.4
	80	0080P2-2-010	2 x 10	4.00
0080P2-2-012		2 x 12	3.33	2 x 13.8
0080P2-2-015		2 x 15	2.67	2 x 17.3
0080P2-2-018		2 x 18	2.22	2 x 20.7
0080P2-2-022		2 x 22	1.82	2 x 25.4
120	0120P2-2-012	2 x 12	5.00	2 x 13.4
	0120P2-2-015	2 x 15	4.00	2 x 16.8
	0120P2-2-018	2 x 18	3.33	2 x 20.2
	0120P2-2-022	2 x 22	2.73	2 x 24.5
	0120P2-2-055	2 x 55	1.03	2 x 61.3

Power VA	Part Number	Secondary		
	Primary 2x115V	Full Load V	Current A	Open Circuit V
160	0160P2-2-012	2 x 12	6.67	2 x 13.5
	0160P2-2-015	2 x 15	5.33	2 x 16.6
	0160P2-2-018	2 x 18	4.44	2 x 20.0
	0160P2-2-022	2 x 22	3.64	2 x 24.5
	0160P2-2-030	2 x 30	2.67	2 x 33.5
	0160P2-2-055	2 x 55	1.45	2 x 61.2
225	0225P2-2-012	2 x 12	9.38	2 x 13.1
	0225P2-2-015	2 x 15	7.50	2 x 16.5
	0225P2-2-018	2 x 18	6.25	2 x 19.7
	0225P2-2-022	2 x 22	5.11	2 x 24.2
	0225P2-2-024	2 x 24	4.69	2 x 26.5
	0225P2-2-030	2 x 30	3.75	2 x 32.8
300	0300P2-2-012	2 x 12	12.5	2 x 13.1
	0300P2-2-018	2 x 18	8.33	2 x 19.4
	0300P2-2-022	2 x 22	6.82	2 x 23.8
	0300P2-2-025	2 x 25	6.00	2 x 27.1
	0300P2-2-030	2 x 30	5.00	2 x 32.5
	0300P2-2-035	2 x 35	4.29	2 x 37.8
	0300P2-2-055	2 x 55	2.73	2 x 59.6
500	0500P2-2-020	2 x 20	12.50	2 x 21.5
	0500P2-2-025	2 x 25	10.00	2 x 26.7
	0500P2-2-030	2 x 30	8.33	2 x 32.3
	0500P2-2-040	2 x 40	6.25	2 x 43.0
	0500P2-2-055	2 x 55	4.55	2 x 59.0
625	0625P2-2-018	2 x 18	17.4	2 x 19.3
	0625P2-2-022	2 x 22	14.2	2 x 23.5
	0625P2-2-040	2 x 40	7.81	2 x 42.8
	0625P2-2-045	2 x 45	6.94	2 x 48.3
	0625P2-2-050	2 x 50	6.25	2 x 53.8
	0625P2-2-055	2 x 55	5.68	2 x 58.9
800	0625P2-4-012	4 x 12	13.0	4 x 12.9
	0800P2-2-040	2 x 40	10.00	2 x 42.4
	0800P2-2-045	2 x 45	8.89	2 x 47.6
	0800P2-2-050	2 x 50	8.09	2 x 52.9
	0800P2-2-055	2 x 55	7.27	2 x 58.1
1000	1000P2-2-018	2 x 18	27.8	2 x 18.8
	1000P2-2-022	2 x 22	22.7	2 x 23.5
	1000P2-2-040	2 x 40	12.5	2 x 42.2
	1000P2-2-045	2 x 45	11.1	2 x 47.5
	1000P2-2-050	2 x 50	10.0	2 x 52.8
	1000P2-2-055	2 x 55	9.09	2 x 58.1
	1000P2-4-022	4 x 22	11.4	4 x 23.5
	1000P2-4-028	4 x 28	8.93	4 x 29.3

Schematic

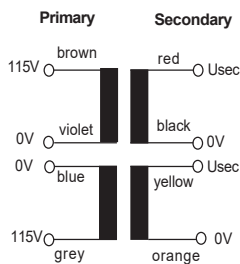

Primary: 2 x 115V / 48 - 60Hz for series or parallel connection
Secondary: 2 or 4xUsec for series or parallel connection

Schematic

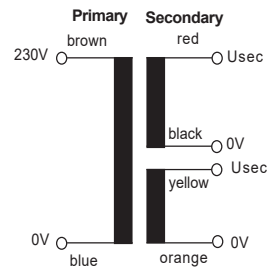

Primary: 230V / 48 - 60Hz
Secondary: 2 or 4xUsec for series or parallel connection

Standard Open & Encapsulated Toroidal Transformers



Nominal Power VA	Primary			Core Loss W	Copper Loss Typical		Dimensions and weight without Mounting Disks			Potted in Polyamid Housing		
	Full Load Current A	No Load Current mA	Copper Resistance T = 20°C Ohm		T = 20°C W	T =120°C W	Ø mm	Height* mm	Weight kg	Ø mm	Height mm	Center Hole for Mounting Bolt Ø
15	0.08	2.0	178.0	0.21	1.8	2.5	60	31	0.3	63	34.5	5.1
30	0.15	2.8	92.0	0.26	3.6	5.0	70	32	0.5	81	39	5.1
50	0.25	5.0	42.0	0.43	4.7	6.6	80	35	0.7	87	42	5.1
80	0.40	5.6	27.0	0.51	8.4	11.0	92	36	1.0	97	44	6.1
120	0.53	8.5	15.5	0.76	9.9	13.9	92	45	1.3	104	52	6.1
160	0.79	10.0	10.5	0.97	11.9	20.8	104	44	1.6	115	53	6.1
225	1.08	14.0	6.6	1.30	15.2	21.3	112	48	2.1	126	52	6.1
300	1.41	17.0	4.2	1.70	16.1	22.5	115	58	2.5	126	65	6.1
500	2.32	23.0	1.83	2.50	22.1	31.0	135	60	3.9	147	65	8.2
625	2.90	28.0	1.50	3.10	27.9	39.0	140	70	4.6	--	--	--
800	3.71	33.1	1.30	3.65	28.9	41.2	162	60	5.1	--	--	--
1000	4.56	38.0	0.88	4.80	30.7	43.0	160	72	6.9	--	--	--

* Allow an extra 3mm for mounting kit and 3-4mm to the dimensions where the leads emerge

Material **Temperature Class**

Copper (Pri. & Sec) H (180°C)

Isolation between
Primary & Secondary B (130°C)

Lead isolation A (105°C)

Leads

Primary : Double insulated leads,
 150mm long, 10mm stripped

Secondary : PVC insulated,
 150mm long, 10mm tinned

Approvals:

Approved to EN61558 & IEC 61558

DEKRA Nr. 2161054.01 for Safety Isolation Transformers

DEKRA Nr. 2161054.02 for Isolation Transformers

Marked with the ENEC KEMA-KEUR stamp of approval

Approved to UL 5085-1 (General Purpose Transformers)

File XPTQ2.E215495 - USA

File XPTQ8.E215495 - Canada

Toroidal Transformers with Dual Secondary Winding • 55xxx Series
Features

- High quality manufacturing and testing in accordance to EN61558, EN60065 and Directive 2014/35/EU
- Tested and approved by KEMA to EN61558
- Manufactured in ISO 9001:2016, ISO 14001:2016 & OHSAS 18001:2008 certified Talema facility
- Fully RoHS & REACH Compliant



Power [VA]	Part Number	Mounting Style	Primary Voltage [V]	Secondary Voltage [V]	Secondary Current [A]	No Load Voltage U ₀ [V]	Fuse (Sec) [A]	Dimensions (ODxHT) mm	Weight Kg
15	55 100 - P1S2	S	230	2 x 12	0.625	2 x 13.89	0.630	62 x 32	0.31
	55 300 - P1S2	H							
	55 101 - P1S2	S	230	2 x 15	0.500	2 x 17.29	0.500		
	55 301 - P1S2	H							
	55 102 - P1S2	S	230	2 x 18	0.417	2 x 20.91	0.400		
	55 302 - P1S2	H							
	55 103 - P1S2	S	230	2 x 25	0.300	2 x 29.07	0.315		
55 303 - P1S2	H								
30	55 110 - P1S2	S	230	2 x 12	1.250	2 x 14.19	1.250	74 x 34	0.44
	55 310 - P1S2	H							
	55 111 - P1S2	S	230	2 x 15	1.000	2 x 17.74	1.000		
	55 311 - P1S2	H							
	55 112 - P1S2	S	230	2 x 18	0.833	2 x 21.44	0.800		
	55 312 - P1S2	H							
	55 113 - P1S2	S	230	2 x 25	0.600	2 x 29.75	0.630		
55 313 - P1S2	H								
50	55 120 - P1S2	S	230	2 x 12	2.083	2 x 13.71	2.000	84 x 34	0.63
	55 320 - P1S2	H							
	55 121 - P1S2	S	230	2 x 15	1.667	2 x 17.22	1.600		
	55 321 - P1S2	H							
	55 122 - P1S2	S	230	2 x 18	1.389	2 x 20.39	1.600		
	55 322 - P1S2	H							
	55 123 - P1S2	S	230	2 x 25	1.000	2 x 28.78	1.000		
	55 323 - P1S2	H							
	55 129 - P1S2	S	230	2 x 55	0.455	2 x 63.22	0.500		
55 329 - P1S2	H								
80	55 130 - P1S2	S	230	2 x 12	3.333	2 x 13.60	3.150	95 x 36	0.87
	55 330 - P1S2	H							
	55 131 - P1S2	S	230	2 x 15	2.667	2 x 17.11	2.500		
	55 331 - P1S2	H							
	55 132 - P1S2	S	230	2 x 18	2.222	2 x 20.50	2.000		
	55 332 - P1S2	H							
	55 133 - P1S2	S	230	2 x 25	1.600	2 x 28.55	1.6000		
	55 333 - P1S2	H							
	55 139 - P1S2	S	230	2 x 55	0.727	2 x 63.33	0.800		
55 339 - P1S2	H								
120	55 140 - P1S2	S	230	2 x 12	5.000	2 x 13.42	5.000	96 x 47	1.20
	55 340 - P1S2	H							
	55 141 - P1S2	S	230	2 x 15	4.000	2 x 16.82	4.000		
	55 341 - P1S2	H							
	55 142 - P1S2	S	230	2 x 18	3.333	2 x 20.04	3.150		
	55 342 - P1S2	H							
	55 143 - P1S2	S	230	2 x 25	2.400	2 x 28.02	2.500		
	55 343 - P1S2	H							
	55 149 - P1S2	S	230	2 x 55	1.091	2 x 61.83	1.000		
55 349 - P1S2	H								

Toroidal Transformers with Dual Secondary Winding • 55xxx Series

Power [VA]	Part Number	Mounting Style	Primary Voltage [V]	Secondary Voltage [V]	Secondary Current [A]	No Load Voltage Uo [V]	Fuse (Sec) [A]	Dimensions (ODxHT) mm	Weight Kg
160	55 150 - P1S2	S	230	2 x 12	6.667	2 x 13.26	6.300	110 x 46	1.50
	55 350 - P1S2	H							
	55 151 - P1S2	S							
	55 351 - P1S2	H	230	2 x 15	5.333	2 x 16.63	5.000		
	55 152 - P1S2	S							
	55 352 - P1S2	H	230	2 x 18	4.444	2 x 19.79	5.000		
	55 153 - P1S2	S							
	55 353 - P1S2	H							
	55 154 - P1S2	S	230	2 x 30	2.667	2 x 32.86	2.500		
	55 354 - P1S2	H							
55 159 - P1S2	S	230	2 x 55	1.455	2 x 60.17	1.600			
55 359 - P1S2	H								
225	55 160 - P1S2	S	230	2 x 12	9.375	2 x 13.14	10.000	118 x 50	1.90
	55 360 - P1S2	H							
	55 161 - P1S2	S	230	2 x 15	7.500	2 x 16.32	8.000		
	55 361 - P1S2	H							
	55 162 - P1S2	S	230	2 x 18	6.250	2 x 19.71	6.300		
	55 362 - P1S2	H							
	55 163 - P1S2	S	230	2 x 25	4.500	2 x 27.42	5.000		
	55 363 - P1S2	H							
	55 164 - P1S2	S	230	2 x 30	3.750	2 x 32.86	4.000		
	55 364 - P1S2	H							
55 169 - P1S2	S	230	2 x 55	2.045	2 x 59.82	2.000			
55 369 - P1S2	H								
300	55 173 - P1S2	S	230	2 x 25	6.000	2 x 26.85	6.300	118 x 60	2.40
	55 373 - P1S2	H							
	55 174 - P1S2	S	230	2 x 30	5.000	2 x 32.52	5.000		
	55 374 - P1S2	H							
	55 175 - P1S2	S	230	2 x 35	4.286	2 x 37.88	4.000		
	55 375 - P1S2	H							
	55 179 - P1S2	S	230	2 x 55	2.727	2 x 59.66	2.500		
55 379 - P1S2	H								
500	55 183 - P1S2	S	230	2 x 25	10.000	2 x 26.71	10.000	140 x 62	3.50
	55 383 - P1S2	H							
	55 184 - P1S2	S	230	2 x 30	8.333	2 x 32.27	8.000		
	55 384 - P1S2	H							
	55 185 - P1S2	S	230	2 x 35	7.143	2 x 37.47	8.000		
	55 385 - P1S2	H							
	55 186 - P1S2	S	230	2 x 40	6.250	2 x 43.03	6.300		
	55 386 - P1S2	H							
	55 187 - P1S2	S	230	2 x 45	5.556	2 x 48.59	5.000		
	55 387 - P1S2	H							
	55 188 - P1S2	S	230	2 x 50	5.000	2 x 53.42	5.000		
	55 388 - P1S2	H							
55 189 - P1S2	S	230	2 x 55	4.545	2 x 58.61	5.000			
55 389 - P1S2	H								
625	55 196 - P1S2	S	230	2 x 40	7.813	2 x 42.32	8.000	140 x 75	4.40
	55 396 - P1S2	H							
	55 197 - P1S2	S	230	2 x 45	6.944	2 x 47.38	8.000		
	55 397 - P1S2	H							
	55 198 - P1S2	S	230	2 x 50	6.250	2 x 52.44	6.300		
	55 398 - P1S2	H							
	55 199 - P1S2	S	230	2 x 55	5.682	2 x 57.96	6.300		
55 399 - P1S2	H								
800	55 206 - P1S2	S	230	2 x 40	10.000	2 x 42.38	10.000	165 x 65	5.30
	55 406 - P1S2	H							
	55 207 - P1S2	S	230	2 x 45	8.889	2 x 47.62	8.000		
	55 407 - P1S2	H							
	55 208 - P1S2	S	230	2 x 50	8.000	2 x 52.86	8.000		
	55 408 - P1S2	H							
	55 209 - P1S2	S	230	2 x 55	7.273	2 x 58.10	8.000		
55 409 - P1S2	H								
1000	55 216 - P1S2	S	230	2 x 40	12.500	2 x 41.76	12.500	165 x 75	6.40
	55 416 - P1S2	H							
	55 217 - P1S2	S	230	2 x 45	11.111	2 x 47.06	10.000		
	55 417 - P1S2	H							
	55 218 - P1S2	S	230	2 x 50	10.000	2 x 52.35	10.000		
	55 418 - P1S2	H							
	55 219 - P1S2	S	230	2 x 55	9.091	2 x 57.65	10.000		
55 419 - P1S2	H								

Standard Mounting

“S” – Standard mounting; “H” – centre potted with through hole

Toroidal Transformers (12V Halogen Lamps) • 56xxx Series

Features

- High quality manufacturing and testing in accordance to EN61558, EN60065 and Directive 2014/35/EU
- Tested and approved by KEMA to EN61558
- Manufactured in ISO 9001:2016, ISO 14001:2016 & OHSAS 18001:2008 certified Talema facility
- Fully RoHS & REACH Compliant



12V Halogen Lamps

Power [VA]	Part Number	Primary Voltage [V]	Secondary Voltage [V]	Secondary Current [A]	No Load Voltage U _o [V]	Fuse (Sec) [A]	Dimensions (ODxHT) mm	Weight Kg
15	56 021 - P1S1	230	11.8	1.27	13.7	1.25	62 x 32	0.31
30	56 022 - P1S1	230	11.8	2.54	13.8	2.50	74 x 34	0.44
50	56 001 - P1S1	230	11.8	4.24	13.5	5.00	84 x 34	0.63
80	56 002 - P1S1	230	11.8	6.78	13.5	8.00	95 x 36	0.87
120	56 003 - P1S1	230	11.8	10.17	13.1	12.50	96 x 47	1.20
160	56 004 - P1S1	230	11.8	13.56	12.9	16.00	110 x 46	1.50
200	56 005 - P1S1	230	11.8	16.95	12.7	20.00	116 x 48	1.90
250	56 006 - P1S1	230	11.8	21.19	12.8	25.00	118 x 55	2.20
300	56 007 - P1S1	230	11.8	25.42	12.6	25.00	118 x 60	2.40
400	56 008 - P1S1	230	11.8	33.90	12.6	35.00	140 x 55	3.10
500	56 009 - P1S1	230	11.8	42.37	12.6	50.00	140 x 62	3.50

12V Halogen Lamps with Auto-Reset Thermal Switch

Power [VA]	Part Number	Primary Voltage [V]	Secondary Voltage [V]	Secondary Current [A]	No Load Voltage U _o [V]	Fuse (Sec) [°C]	Dimensions (ODxHT) mm	Weight Kg
15	56 031 - P1S1	230	11.8	1.27	13.7	110	62 x 32	0.31
30	56 032 - P1S1	230	11.8	2.54	13.8	110	74 x 34	0.44
50	56 011 - P1S1	230	11.8	4.24	13.5	110	84 x 34	0.63
80	56 012 - P1S1	230	11.8	6.78	13.5	110	95 x 36	0.87
120	56 013 - P1S1	230	11.8	10.17	13.1	110	96 x 47	1.20
160	56 014 - P1S1	230	11.8	13.56	12.9	110	110 x 46	1.50
200	56 015 - P1S1	230	11.8	16.95	12.7	110	116 x 48	1.90
250	56 016 - P1S1	230	11.8	21.19	12.8	110	118 x 55	2.20
300	56 017 - P1S1	230	11.8	25.42	12.6	110	118 x 60	2.40

Toroidal Power Transformers • 58xxx Series
Features

- 200mm (approx.) flying leads
- Small size and low weight compared with traditional lamination types
- Low radiated magnetic field
- Low induced noise (hum)
- High quality manufacturing and testing in accordance to EN61558-1, EN60065 and Directive 2014/35/EU
- Manufactured in ISO 9001:2016, ISO 14001:2016 & OHSAS 18001:2008 certified Talema facility
- Fully RoHS & REACH Compliant



"x" in the part denotes mounting Styles (S, B, H or D)

Power [VA]	Part Number	Mounting Style	Primary Voltage [V]	Secondary Voltage [V]	Secondary Current [A]	No Load Voltage [V]	Fuse (Sec) [A]	Dimensions (ODxHT) mm	Weight Kg
12	58-0012-012-x	S B H D	230	12	1.000	13.96	1.00	57 x 29	0.26
	58-0012-018-x	S B H D	230	18	0.667	20.83	0.63		
	58-0012-024-x	S B H D	230	24	0.500	27.92	0.50		
	58-0012-030-x	S B H D	230	30	0.400	34.94	0.40		
20	58-0020-012-x	S B H D	230	12	1.667	13.96	1.60	57 x 35	0.35
	58-0020-018-x	S B H D	230	18	1.111	20.85	1.25		
	58-0020-024-x	S B H D	230	24	0.833	27.64	1.00		
	58-0020-030-x	S B H D	230	30	0.667	34.53	0.63		
32	58-0032-012-x	S B H D	230	12	2.667	13.96	2.50	70 x 36	0.48
	58-0032-018-x	S B H D	230	18	1.778	20.85	2.00		
	58-0032-024-x	S B H D	230	24	1.333	27.64	1.60		
	58-0032-030-x	S B H D	230	30	1.067	34.62	1.00		
50	58-0050-012-x	S B H D	230	12	4.167	13.70	4.00	80 x 33	0.63
	58-0050-018-x	S B H D	230	18	2.778	20.60	3.15		
	58-0050-024-x	S B H D	230	24	2.083	27.28	2.00		
	58-0050-030-x	S B H D	230	30	1.667	34.18	1.60		
	58-0050-048-x	S B H D	230	48	1.042	54.67	1.00		
	58-0050-060-x	S B H D	230	60	0.833	68.14	0.80		
80	58-0080-012-x	S B H D	230	12	6.667	13.38	6.30	80 x 44	0.89
	58-0080-018-x	S B H D	230	18	4.444	20.16	5.00		
	58-0080-024-x	S B H D	230	24	3.333	26.76	3.15		
	58-0080-030-x	S B H D	230	30	2.667	33.37	2.50		
	58-0080-048-x	S B H D	230	48	1.667	53.35	1.60		
	58-0080-060-x	S B H D	230	60	1.333	66.73	1.25		
100	58-0100-012-x	S B H D	230	12	8.333	13.56	8.00	93 x 42	1.10
	58-0100-018-x	S B H D	230	18	5.556	20.48	6.30		
	58-0100-024-x	S B H D	230	24	4.167	27.27	4.00		
	58-0100-030-x	S B H D	230	30	3.333	34.05	3.15		
	58-0100-048-x	S B H D	230	48	2.083	54.39	2.00		
	58-0100-060-x	S B H D	230	60	1.667	67.96	1.60		
	58-0100-115-x	S B H D	230	115	0.870	128.85	1.00		
	58-0100-230-x	S B H D	230	230	0.435	257.97	0.50		

Toroidal Power Transformers • 58xxx Series

Power [VA]	Part Number	Mounting Style				Primary Voltage [V]	Secondary Voltage [V]	Secondary Current [A]	No Load Voltage [V]	Fuse (Sec) [A]	Dimensions (ODxHT) mm	Weight Kg
125	58-0125-012-x	S	B	H	D	230	12	10.417	13.40	10.00	94 x 46	1.20
	58-0125-018-x	S	B	H	D	230	18	6.944	20.02	8.00		
	58-0125-024-x	S	B	H	D	230	24	5.210	26.80	5.00		
	58-0125-030-x	S	B	H	D	230	30	4.167	33.58	4.00		
	58-0125-048-x	S	B	H	D	230	48	2.604	53.60	2.50		
58-0125-060-x	S	B	H	D	230	60	2.083	67.00	2.00			
160	58-0160-012-x	S	B	H	D	230	12	13.333	13.18	12.50	99 x 51	1.50
	58-0160-018-x	S	B	H	D	230	18	8.889	19.87	10.00		
	58-0160-024-x	S	B	H	D	230	24	6.667	26.35	6.30		
	58-0160-030-x	S	B	H	D	230	30	5.333	33.05	5.00		
	58-0160-048-x	S	B	H	D	230	48	3.333	52.70	3.15		
	58-0160-060-x	S	B	H	D	230	60	2.667	65.87	2.50		
	58-0160-115-x	S	B	H	D	230	115	1.391	125.27	1.60		
58-0160-230-x	S	B	H	D	230	230	0.696	250.10	0.80			
200	58-0200-012-x	S	B	H	D	230	12	16.667	13.05	16.00	115 x 49	1.90
	58-0200-018-x	S	B	H	D	230	18	11.111	19.58	12.50		
	58-0200-024-x	S	B	H	D	230	24	8.333	26.11	8.00		
	58-0200-030-x	S	B	H	D	230	30	6.667	32.63	6.30		
	58-0200-048-x	S	B	H	D	230	48	4.167	52.44	4.00		
	58-0200-060-x	S	B	H	D	230	60	3.333	65.04	3.15		
	58-0200-115-x	S	B	H	D	230	115	1.739	124.23	2.00		
58-0200-230-x	S	B	H	D	230	230	0.870	246.65	1.00			
250	58-0250-012-x	S	B	H	D	230	12	20.833	13.00	20.00	117 x 54	2.20
	58-0250-018-x	S	B	H	D	230	18	13.889	19.63	16.00		
	58-0250-024-x	S	B	H	D	230	24	10.417	26.01	10.00		
	58-0250-030-x	S	B	H	D	230	30	8.333	32.38	8.00		
	58-0250-048-x	S	B	H	D	230	48	5.208	52.02	5.00		
58-0250-060-x	S	B	H	D	230	60	4.167	64.77	4.00			
300	58-0300-012-x	S	B	H	D	230	12	25.000	13.04	25.00	117 x 61	2.50
	58-0300-018-x	S	B	H	D	230	18	16.667	19.56	16.00		
	58-0300-024-x	S	B	H	D	230	24	12.500	26.08	12.50		
	58-0300-030-x	S	B	H	D	230	30	10.000	32.31	10.00		
	58-0300-048-x	S	B	H	D	230	48	6.250	51.87	6.30		
	58-0300-060-x	S	B	H	D	230	60	5.000	64.32	5.00		
	58-0300-115-x	S	B	H	D	230	115	2.609	122.71	3.15		
58-0300-230-x	S	B	H	D	230	230	1.300	246.70	1.00			
400	58-0400-012-x	S	B	H	-	230	12	33.333	12.64	35.00	137 x 54	3.20
	58-0400-024-x	S	B	H	-	230	24	16.667	25.59	16.00		
	58-0400-030-x	S	B	H	-	230	30	13.333	31.91	12.50		
	58-0400-048-x	S	B	H	-	230	48	8.333	51.18	8.00		
	58-0400-060-x	S	B	H	-	230	60	6.667	64.14	6.30		
	58-0400-230-x	S	B	H	-	230	230	1.739	242.64	2.00		
500	58-0500-012-x	S	B	H	-	230	12	41.667	12.61	50.00	140 x 64	3.90
	58-0500-024-x	S	B	H	-	230	24	20.800	25.23	25.00		
	58-0500-030-x	S	B	H	-	230	30	16.667	31.90	16.00		
	58-0500-048-x	S	B	H	-	230	48	10.417	50.82	10.00		
	58-0500-060-x	S	B	H	-	230	60	8.333	63.44	8.00		
58-0500-230-x	S	B	H	-	230	230	2.170	241.87	2.50			
630	58-0630-012-x	S	B	H	-	230	12	52.200	12.28	63.00	164 x 58	4.90
	58-0630-048-x	S	B	H	-	230	48	13.125	50.34	12.50		
	58-0630-060-x	S	B	H	-	230	60	10.500	63.03	10.00		
800	58-0800-024-x	S	B	H	-	230	24	33.300	25.08	35.00	166 x 67	6.00
	58-0800-048-x	S	B	H	-	230	48	16.667	50.17	16.00		
	58-0800-060-x	S	B	H	-	230	60	13.333	62.94	12.50		

Standard Mounting

- "S" - Supplied with standard mounting kit consisting of one dished washer and two neoprene pads
- "B" - Centre potted from below with threaded insert for subsequent mounting
- "H" - Centre potted with through hole for subsequent mounting
- "D" - With DIN rail mounting bracket

Toroidal Lighting Power Transformers

High quality open style toroidal transformers with a single 230VAC 50/60Hz primary winding. Single 11.8V secondary winding, suitable for 12V Halogen lamps

Features

- Primary incorporates an auto-reset thermal switch, rated at 120°C +/-5°C
- Output voltage 11.8V +/- 1.5% (at nominal input and full load)
- Small size and low weight compared with traditional stacked lamination types.
- Extremely low level of radiated magnetic field
- Very low induced noise (hum)
- Very low iron loss
- Double insulated primary leads
- UL Recognised to UL506, under family approval file E215495
- Meets all requirements of Class E (120°C)
- High quality manufacturing and testing in accordance to EN61558, EN60742, EN60950, EN60065, VDE0551, VDE0550 and BS415
- Tested and Approved by KEMA to EN61558
- Secondary voltage tolerance 1% at nominal input.
- Maximum ambient operating temperature +40°C
- Neoprene pads: 5KV isolation
- Manufactured in an ISO 9001:2015 and ISO 14001:2015 certified Talema facility
- Fully RoHS & REACH Compliant

Schematic

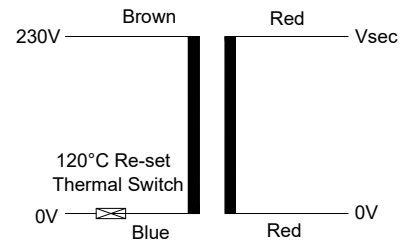

Rated VA	Part Number	Regulation % Typical	Temperature Rise [K]	Dimensions* Diameter [mm]	Height [mm]	Weight [Kg]
50	91931-P1S1	15	46	80	33	0.65
105	91932-P1S1	11	49	93	46	1.05
150	91933-P1S1	8.5	48	105	42	1.35
200	91934-P1S1	7.6	51	105	50	1.75

Notes:

- Each transformer is supplied with a dished washer and protection pads for single hole fixing.
- *Allow extra 4mm for mounting kit, allow extra 5mm where leads emerge
- Leads: PVC insulated 150mm long

Special Transformers • Standard Configuration & Customer Specification
Special Transformers

If we do not have a customer or stock standard which meets your requirements, we can offer expert engineering assistance to develop the special transformer you need. We stock the materials for the sizes shown on table 2 (page 6) and can supply other sizes as well on short notice.

Capabilities

- Power 5VA - 7500VA / phase
- Assembled 3 phase sets
- Special sizes - extremely flat or small Diameter
- Static copper shielding
- Magnetic shielding
- Operating frequencies to 20kHz
- Potting in special housings tp 1200VA
- Secondary voltages to 1000 V
- Up to 8 primaries or taps
- Up to 30 secondaries or taps
- Reinforced dielectric to 5000V_{eff}

Power VA	Core Loss W	Copper Loss (typical)		Dimensions mm		Weight kg
		T = 20°C W	T = 120°C W	O.D. Ø	Height	
5	0.16	0.6	0.8	51	27	0.1
10	0.14	1.1	1.6	58	29	0.3
15	0.21	1.8	2.5	60	31	0.3
20	0.26	2.4	3.3	60	36	0.4
30	0.26	3.6	5.0	70	32	0.5
50	0.39	4.7	6.6	70	44	0.7
50	0.43	4.7	6.6	80	35	0.7
80	0.65	8.4	11.8	80	45	1.0
80	0.51	8.4	11.8	92	36	1.0
120	0.76	9.9	13.9	92	45	1.3
160	1.00	14.9	20.8	92	58	1.5
160	0.97	14.9	20.8	104	44	1.6
225	1.30	15.2	21.3	112	48	2.1
250	1.30	15.7	22.0	95	69	2.3
250	1.20	15.7	22.0	135	38	2.3
300	1.70	16.1	22.5	115	58	2.5
375	2.10	20.0	28.0	115	68	3.0
375	1.90	20.0	28.0	135	48	3.0
500	2.50	22.1	31.0	135	60	3.9
625	3.10	27.9	39.0	140	70	4.6
625	2.90	27.9	42.0	160	48	4.6
800	3.80	30.0	42.0	160	60	5.5
1000	4.80	30.7	43.0	160	72	6.9
1000	4.40	30.7	43.0	200	48	6.9
1300	5.70	42.9	60.0	160	82	8.8
1300	5.90	44.3	62.0	200	65	8.8
1600	7.30	45.0	63.0	200	75	10.5
1900	8.80	47.1	66.0	200	85	12.0
2200	10.30	55.3	76.0	205	90	13.5
2500	11.70	59.3	83.0	205	105	16.6
2500	13.30	59.3	83.0	245	80	15.2
2800	13.30	68.0	95.0	245	80	16.0
3200	15.60	70.0	97.0	245	90	18.6
3700	17.80	73.0	102.0	245	100	21.2
4400	16.80	84.0	116.0	275	95	24.5
5000	22.40	87.0	120.0	275	105	28.0
6000	25.20	97.0	135.0	290	120	31.0
7500	28.60	110.0	153.0	320	100	39.0

Standard Miniature Toroidal Transformers

Features

- Tapped 0-115-230V, 50/60Hz Primary windings suitable for 115V or 230V
- Lower strayfield
- High efficiency
- Reduced standby current
- Small size & low weight
- Extremely low level of radiated magnetic field
- Very low induced noise (hum)
- Very low iron loss
- Test Voltage Primary - Secondary 4.0 KV
- 100% electrical and flash tested
- Ambient operating temp.: +60°C Max.
- Insulation system recognized for Class A (105°C) meets all requirements of Class E (120°C)
- Manufactured in an ISO 9001:2015 and ISO 14001:2015 certified Talema facility
- Fully RoHS & REACH Compliant

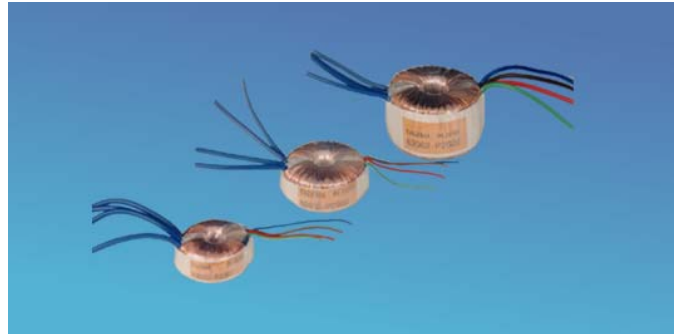

Standards

- High quality manufacturing and testing in accordance to EN61558, EN60950, EN60065 and BS415
- Tested and Approved by DEKRA to EN61558
- Recognized to UL5085, under family approval file E215495



Power VA	Part Number 2 x 115V Primary	Part Number 0 - 115 - 230V Primary	Part Number 0 - 230V Primary	Secondary Full Load Voltage V	Secondary Current mA	Open Circuit Voltage V
1.6	62000	60000	61000	2 x 7	114	2 x 8.9
	62001	60001	61001	2 x 9	89	2 x 11.6
	62002	60002	61002	2 x 12	67	2 x 15.4
	62003	60003	61003	2 x 15	53	2 x 19.3
	62004	60004	61004	2 x 18	44	2 x 23.4
	62005	60005	61005	2 x 22	36	2 x 28.2
3.2	62010	60010	61010	2 x 7	229	2 x 10.2
	62011	60011	61011	2 x 9	178	2 x 13.0
	62012	60012	61012	2 x 12	133	2 x 17.3
	62013	60013	61013	2 x 15	107	2 x 21.4
	62014	60014	61014	2 x 18	89	2 x 25.7
	62015	60015	61015	2 x 22	73	2 x 30.5
5.0	62020	60020	61020	2 x 7	357	2 x 9.7
	62021	60021	61021	2 x 9	278	2 x 12.4
	62022	60022	61022	2 x 12	208	2 x 17.0
	62023	60023	61023	2 x 15	167	2 x 21.3
	62024	60024	61024	2 x 18	139	2 x 25.5
	62025	60025	61025	2 x 22	114	2 x 30.5
7.0	62030	60030	61030	2 x 7	500	2 x 9.5
	62031	60031	61031	2 x 9	389	2 x 12.2
	62032	60032	61032	2 x 12	292	2 x 16.2
	62033	60033	61033	2 x 15	233	2 x 20.3
	62034	60034	61034	2 x 18	194	2 x 24.3
	62035	60035	61035	2 x 22	159	2 x 29.7

Standard Miniature Toroidal Transformer

Power VA	Part Number 2 x 115V Primary	Part Number 0 - 115 - 230V Primary	Part Number 0 - 230V Primary	Secondary Full Load Voltage V	Secondary Current mA	Open Circuit Voltage V
10	62040	60040	61040	2 x 7	714	2x8.3
	62041	60041	61041	2 x 9	556	2x10.8
	62042	60042	61042	2 x 12	417	2x14.4
	62043	60043	61043	2 x 15	333	2x18.0
	62044	60044	61044	2 x 18	278	2x21.7
	62045	60045	61045	2 x 22	227	2x26.3
15	62050	60050	61050	2 x 7	1071	2 x 8.9
	62051	60051	61051	2 x 9	833	2 x 11.1
	62052	60052	61052	2 x 12	625	2 x 14.8
	62053	60053	61053	2 x 15	500	2 x 18.5
	62054	60054	61054	2 x 18	417	2 x 22.2
	62055	60055	61055	2 x 22	341	2 x 27.2
25	62060	60060	61060	2 x 7	1785	2 x 8.3
	62061	60061	61061	2 x 9	1377	2 x 10.7
	62062	60062	61062	2 x 12	1041	2 x 14.2
	62063	60063	61063	2 x 15	832	2 x 17.8
	62064	60064	61064	2 x 18	694	2 x 21.4
	62065	60065	61065	2 x 22	568	2 x 26.2
35	62070	60070	61070	2 x 7	2500	2 x 8.2
	62071	60071	61071	2 x 9	1944	2 x 10.6
	62072	60072	61072	2 x 12	1458	2 x 14.0
	62073	60073	61073	2 x 15	1166	2 x 17.6
	62074	60074	61074	2 x 18	972	2 x 20.9
	62075	60075	61075	2 x 22	795	2 x 25.7
50	62080	60080	61080	2 x 7	3571	2 x 8.1
	62081	60081	61081	2 x 9	2777	2 x 10.4
	62082	60082	61082	2 x 12	2083	2 x 13.8
	62083	60083	61083	2 x 15	1666	2 x 17.3
	62084	60084	61084	2 x 18	1388	2 x 20.7
	62085	60085	61085	2 x 22	1136	2 x 25.4

Standard Output (Electrical measurements @ 20°C ambient temperature)

Power VA	Dimensions OD x ID x H mm	Weight grams	No Load Regulation ^V/Sec. (%)	^t °C	Efficiency %	No Load mA (typ.)	230V Fuse mA	Secondary Power (Max.)				
								VA	^V / sec. %	^t °C	Efficiency %	Rec. Fuse mA
1.6	37.5x7.0x17.0	71	29	10	77	1.0	32	2.0	60	30	60	32
3.2	42.0x7.0x17.5	89	41	20	70	1.5	32	3.7	80	40	50	50
5.0	47.0x6.0x18.0	115	45	29	70	2.0	50	5.5	80	40	50	63
7.0	47.0x6.8x21.5	145	34	25	74	3.0	63	7.5	70	40	60	80
10	53.5x6.8x23.5	216	20	24	82	3.0	80	12.0	60	45	60	100
15	57.5x7.0x24.0	262	23	27	81	4.0	100	16.0	60	40	65	125
25	58.0x13.8x34.5	388	19.0	28	84	5.0	160	--	--	--	--	--
35	72.0x17.0x33.5	453	17.7	31	85	7.0	200	--	--	--	--	--
50	78.0x22.5x35.0	670	15.5	30	86	8.0	315	--	--	--	--	--

Standard Miniature Toroidal Transformer

Mechanical Drawing - 600xx Series (0-115V-230V Primary)

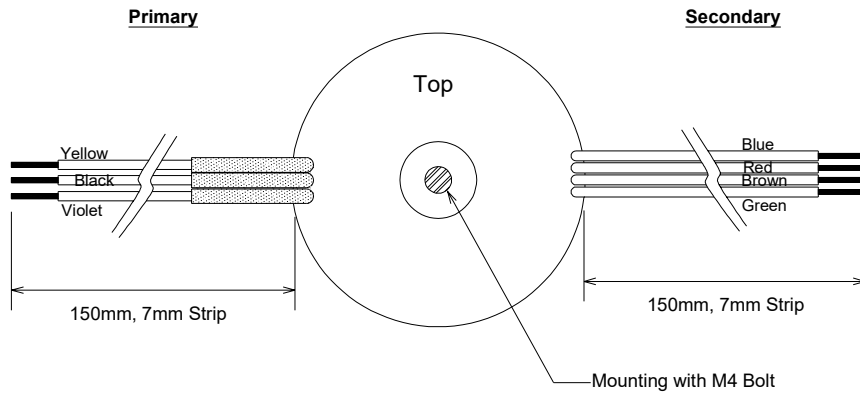

Schematic

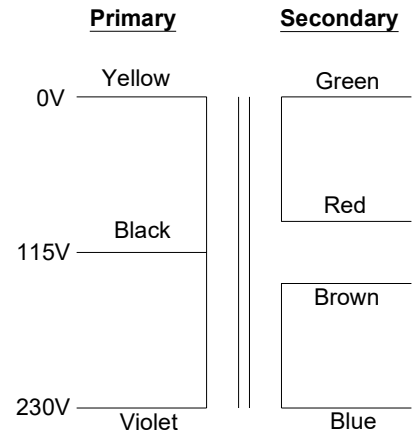

Mechanical Drawing - 61xxx Series (0-230V Primary)

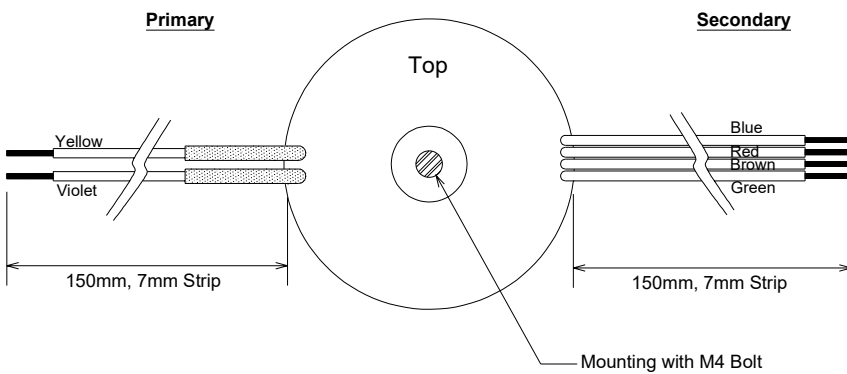

Schematic

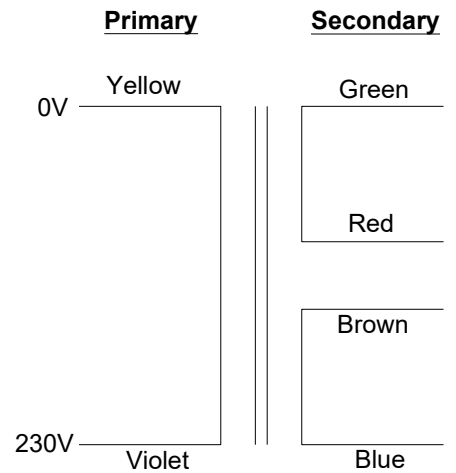

Mechanical Drawing - 620xx Series (2x115V Primary)

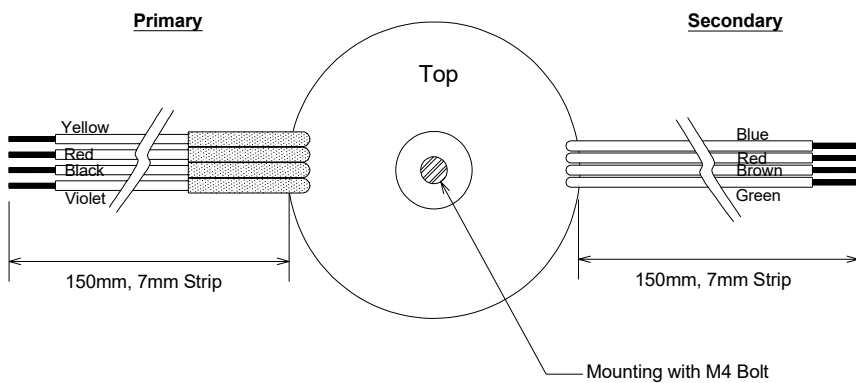

Schematic

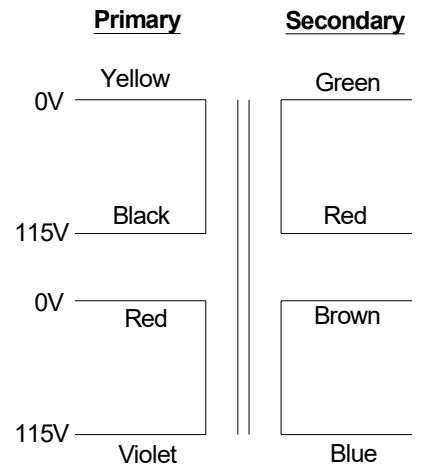

Medical Grade Isolation Transformers

Medical Grade Isolation Transformers are high quality open style toroidal transformers with dual 0-100-120V primary windings suitable for 100/120/200/220/240V, 50/60Hz operation and 2x0-120V isolated secondary windings which may be connected in series or parallel, or used as two independent 120V supplies.



Features

- Power Rating 50VA to 3000VA
- Dual Primary and Dual Secondary windings
- Frequency 50-60Hz
- Isolation 5KVrms Primary - Secondary
- Creepage Distance minimum 8.0mm
- Leakage Current < 100µA
- Tolerance ±3% on Load
- Various mounting methods available
- Recognized to UL60601-1 (Agency Reference - XORU2.E251176 & XORU8.E251176)
- Inbuilt Thermal Protection
- Magnetic Shield to minimize Strayfield Emission **(Optional)**
- Class B Insulation System
- Safety requirement confirms to IEC 601-1 Class I & Class II equipment
- Manufactured in an ISO 9001:2015 and ISO 14001:2015 certified Talema facility
- Fully RoHS & REACH Compliant



Ratings Table

Part No.	Power	Secondary Ratings		No Load Voltage	Lead Wire Gauge		
		120VAC	240VAC		Primary	Secondary	Shield
	VA	A (rms)	A (rms)	V	UL1015		
0050MD-X-00Y	50	0.42	0.21	2x135.5	AWG #22	AWG #22	AWG #22
0100MD-X-00Y	100	0.83	0.42	2x131.9	AWG #22	AWG #22	AWG #22
0200MD-X-00Y	200	1.67	0.83	2x129.1	AWG #22	AWG #22	AWG #22
0230MD-X-00Y	230	1.92	0.96	2x128.8	AWG #22	AWG #22	AWG #22
0300MD-X-00Y	300	2.50	1.25	2x127.5	AWG #22	AWG #22	AWG #22
0350MD-X-00Y	350	2.92	1.46	2x126.7	AWG #20	AWG #20	AWG #20
0400MD-X-00Y	400	3.33	1.67	2x126.4	AWG #20	AWG #20	AWG #20
0500MD-X-00Y	500	4.17	2.08	2x125.6	AWG #18	AWG #20	AWG #18
0600MD-X-00Y	600	5.00	2.50	2x125.4	AWG #18	AWG #20	AWG #18
0650MD-X-00Y	650	5.42	2.71	2x125.2	AWG #18	AWG #18	AWG #18
0760MD-X-00Y	760	6.33	3.17	2x124.8	AWG #16	AWG #18	AWG #18
0800MD-X-00Y	800	6.67	3.33	2x124.4	AWG #16	AWG #18	AWG #18
1000MD-X-00Y	1000	8.33	4.17	2x124.6	AWG #16	AWG #16	AWG #18
1200MD-X-00Y	1200	10.00	5.00	2x123.5	AWG #16	AWG #16	AWG #18
1500MD-X-00Y	1500	12.50	6.25	2x123.4	AWG #14	AWG #16	AWG #18
1800MD-X-00Y	1800	15.00	7.50	2x123.7	AWG #14	AWG #14	AWG #18
2000MD-X-00Y	2000	16.67	8.33	2x122.8	AWG #12	AWG #12	AWG #18
2500MD-X-00Y	2500	20.83	10.42	2x123.3	AWG #12	AWG #12	AWG #18
3000MD-X-00Y	3000	25.00	12.50	2x121.9	AWG #12	AWG #12	AWG #18

Medical Grade Isolation Transformers

Schematic

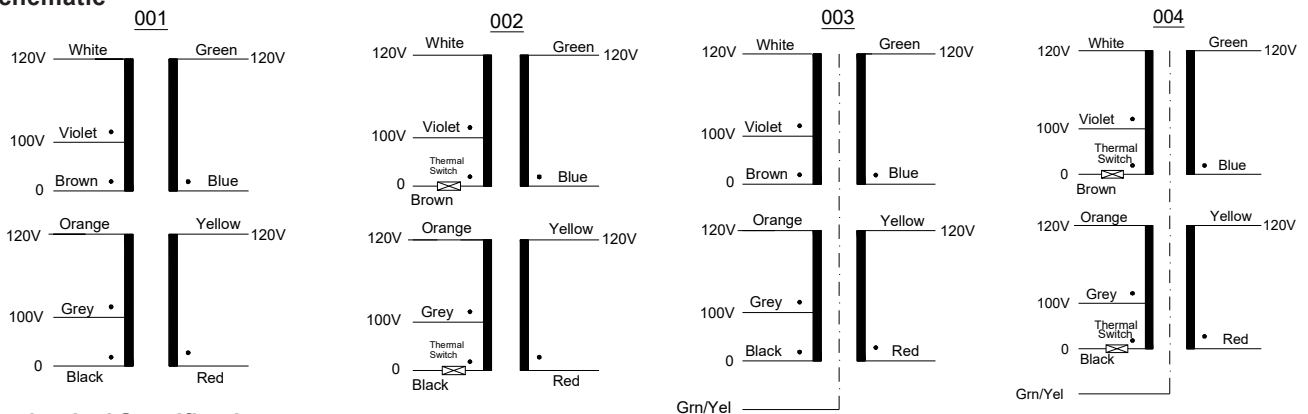

Mechanical Specification

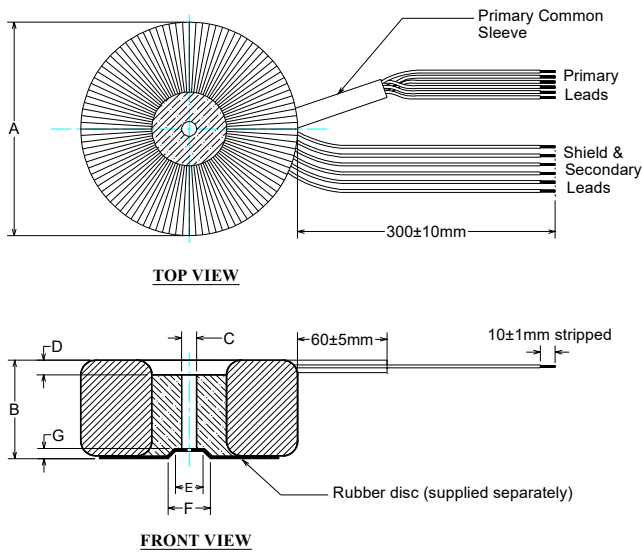

Schematic - Details

Schematic	Construction	Functional Earth	Thermal Protection
001	Reinforced Insulation	No	No
002	Reinforced Insulation	No	Yes (Internal, in-line)
003	Reinforced Insulation	Yes	No
004	Reinforced Insulation	Yes	Yes (Internal, in-line)

Ordering Code

0600 MD - 1 - 001

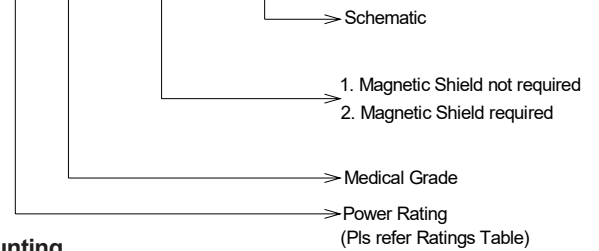

Mounting

- Center-Potted through hole
- Metal Disc and Insulating pads (Optional)

Dimensions

Part No.	Physical Dimensions **							Weight **
	A	B	C	D (± 3.0)	E	F	G	
	mm	mm	mm	mm	mm	mm	mm	Kg
0050MD-X-00Y	81	38	6.35	10	16	26	4	0.8
0100MD-X-00Y	99	41	6.35	10	16	26	4	1.1
0200MD-X-00Y	117	56	6.35	10	19	35	5	2.3
0230MD-X-00Y	117	61	6.35	10	19	35	5	2.4
0300MD-X-00Y	127	62	10	10	22	44	8	2.8
0350MD-X-00Y	132	58	10	19	22	44	8	3.0
0400MD-X-00Y	132	64	10	19	22	44	8	3.4
0500MD-X-00Y	134	70	10	19	22	44	8	4.3
0600MD-X-00Y	150	70	10	19	22	44	8	4.7
0650MD-X-00Y	157	70	10	19	22	44	8	5.1
0760MD-X-00Y	160	71	10	19	22	44	8	5.9
0800MD-X-00Y	165	72	10	19	22	44	8	6.1
1000MD-X-00Y	168	80	12.7	19	22	44	8	8.2
1200MD-X-00Y	183	81	12.7	25	32	44	12	10.0
1500MD-X-00Y	200	90	12.7	25	32	44	12	11.8
1800MD-X-00Y	206	94	12.7	25	32	44	12	13.6
2000MD-X-00Y	215	105	12.7	25	32	44	12	15.5
2500MD-X-00Y	240	115	15	32	42	53	16	21.0
3000MD-X-00Y	265	120	15	32	42	53	16	26.0

** Physical Dimensions & Weight given are approximate

Toroidal PC Transformers • 1.6VA - 50VA

Features

- Dual 115V or 120V, 50/60 Hz Primaries for parallel or series connections
- Lower strayfield
- High efficiency
- Reduced standby current
- Small size and low weight
- Extremely low level of radiated magnetic field
- Very low induced noise (hum)
- Very low iron loss
- Test Voltage Primary - Secondary 4.0 KV
- Ease of mounting - M4 Centre bush
- Ambient operating temp.: +60°C Max. for 1.6VA-25VA; +40°C Max. for 35VA-50VA
- Insulation system recognized for Class A (105°C) meets all requirements of Class E (120°C)
- Manufactured in an ISO 9001:2015 and ISO 14001:2015 certified Talema facility
- Fully RoHS & REACH Compliant

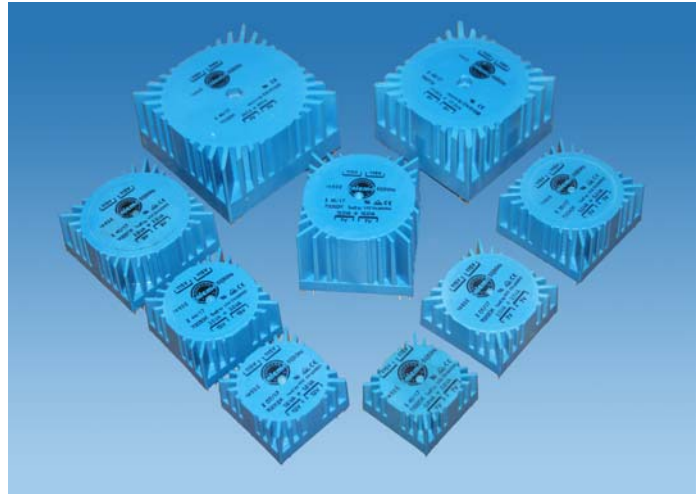

Standards

- High quality manufacturing and testing
- Recognized to UL5085 (70000K to 70065K)
- Recognized to EN60950 by VDE (70000K to 70065K)
- Recognized to UL62368-1 & IEC62368-1 (700xxK & 724xxK)

Power VA	Part Number		Secondary		
	2 x 115V	2 x 120V	Full Load V	Current mA	Open Circuit V
1.6	70000K	72400K	2 x 7	114	2 x 8.9
	70001K	72401K	2 x 9	89	2 x 11.6
	70002K	72402K	2 x 12	67	2 x 15.4
	70003K	72403K	2 x 15	53	2 x 19.3
	70004K	72404K	2 x 18	44	2 x 23.4
	70005K	72405K	2 x 22	36	2 x 28.2
3.2	70010K	72410K	2 x 7	229	2 x 10.2
	70011K	72411K	2 x 9	178	2 x 13.0
	70012K	72412K	2 x 12	133	2 x 17.3
	70013K	72413K	2 x 15	107	2 x 21.4
	70014K	72414K	2 x 18	89	2 x 25.7
	70015K	72415K	2 x 22	73	2 x 31.3
5.0	70020K	72420K	2 x 7	357	2 x 9.7
	70021K	72421K	2 x 9	278	2 x 12.4
	70022K	72422K	2 x 12	208	2 x 17.0
	70023K	72423K	2 x 15	167	2 x 21.3
	70024K	72424K	2 x 18	139	2 x 25.5
	70025K	72425K	2 x 22	114	2 x 30.5
7.0	70030K	72430K	2 x 7	500	2 x 9.5
	70031K	72431K	2 x 9	389	2 x 12.2
	70032K	72432K	2 x 12	292	2 x 16.2
	70033K	72433K	2 x 15	233	2 x 20.3
	70034K	72434K	2 x 18	194	2 x 24.3
	70035K	72435K	2 x 22	159	2 x 29.7
10	70040K	72440K	2 x 7	714	2 x 8.3
	70041K	72441K	2 x 9	556	2 x 10.8
	70042K	72442K	2 x 12	417	2 x 14.4
	70043K	72443K	2 x 15	333	2 x 18.0
	70044K	72444K	2 x 18	278	2 x 21.7
	70045K	72445K	2 x 22	227	2 x 26.3

Power VA	Part Number		Secondary		
	2 x 115V	2 x 120V	Full Load V	Current mA	Open Circuit V
15	70050K	72450K	2 x 7	1071	2 x 8.9
	70051K	72451K	2 x 9	833	2 x 11.1
	70052K	72452K	2 x 12	625	2 x 14.8
	70053K	72453K	2 x 15	500	2 x 18.5
	70054K	72454K	2 x 18	417	2 x 22.2
	70055K	72455K	2 x 22	341	2 x 27.2
25	70060K	72460K	2 x 7	1785	2 x 8.3
	70061K	72461K	2 x 9	1377	2 x 10.7
	70062K	72462K	2 x 12	1041	2 x 14.3
	70063K	72463K	2 x 15	832	2 x 17.8
	70064K	72464K	2 x 18	694	2 x 21.4
	70065K	72465K	2 x 22	568	2 x 26.2
35	70070K	72470K	2 x 7	2500	2 x 8.0
	70071K	72471K	2 x 9	1944	2 x 10.6
	70072K	72472K	2 x 12	1458	2 x 14.0
	70073K	72473K	2 x 15	1166	2 x 17.6
	70074K	72474K	2 x 18	972	2 x 20.9
	70075K	72475K	2 x 22	795	2 x 25.7
50	70080K	72480K	2 x 7	3571	2 x 8.1
	70081K	72481K	2 x 9	2777	2 x 10.4
	70082K	72482K	2 x 12	2083	2 x 13.9
	70083K	72483K	2 x 15	1666	2 x 17.3
	70084K	72484K	2 x 18	1388	2 x 20.8
	70085K	72485K	2 x 22	1136	2 x 25.4

Notes:

Primaries and secondaries for parallel or series connection
Dimensions and schematic in next Page

Toroidal PC Transformers • 1.6VA - 50VA

Standard Outputs (Electrical measurements @ 20°C ambient temperature)

Power VA	Weight Cu gram	No Load Regulation Delta Volts/Sec. (%)	Delta Temp °C	Efficiency %	No Load mA (typ.)	230V Fuse mA	Secondary Range (Max.)				
							VA	Delta Volts/sec. %	Delta Temp °C	Efficiency %	Rec. Fuse mA
1.6	82	29	10	77	1.0	32	2.0	60	30	60	32
3.2	110	43	20	70	1.5	32	3.7	80	40	50	50
5.0	144	40	29	68	2.0	50	5.5	80	40	50	63
7.0	174	34	25	74	3.0	63	7.5	70	40	60	80
10	252	20	24	82	3.0	80	12.0	60	45	60	100
15	304	23	27	80	4.0	100	16.0	60	40	65	125
25	435	19.0	28	83	5.0	160	--	--	--	--	--
35	525	17.7	31	81	7.0	200	--	--	--	--	--
50	685	15.5	30	86	8.0	315	--	--	--	--	--

Dimensions

Dimensions - 7XXXX Series					
Power VA	Dimensions L x W x H mm	Pin Layout		Weight gram	Pin Availability
		XY mm	Pin Size mm		
1.6	39.6x39.6x18.5	35.56	1.0x0.5	82	1 - 16
3.2	44.7x44.7x19.5	40.64	1.0x0.5	110	1 - 18
5.0	49.7x49.7x19.5	45.72	1.0x0.5	144	1 - 18
7.0	49.7x49.7x23.1	45.72	1.0x0.5	174	1 - 18
10	55.0x55.0x26.0	50.80	1.0x0.5	252	1 - 18
15	60.0x60.0x26.3	55.88	1.0x0.5	304	1 - 20
25	60.0x60.0x37.5	55.88	1.0x0.5	435	1 - 20
35	72.0x72.0x37.5	66.04	Ø 1.3	525	1 - 26
50	82.4x82.4x37.5	76.20	Ø 1.3	685	1 - 34

Pin Side View

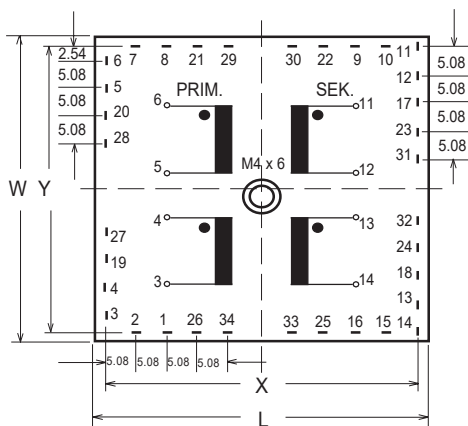

Specifications subject to change, Custom models available on request

- For 230 volt operation, connect primaries in series by connecting pins 5 & 4 together and apply 230 volts across pins 6 & 3
- For 115 volt operation, connect primaries in parallel by connecting pins 6 & 4 together and pins 5 & 3 together, apply 115 volts across pins 6 & 5
- To parallel the secondaries, connect pins 14 to 12 and 13 to 11 take the output across pins 14 & 13
- To place the secondaries in series, connect pins 13 to 12 and take the output across pins 14 & 11

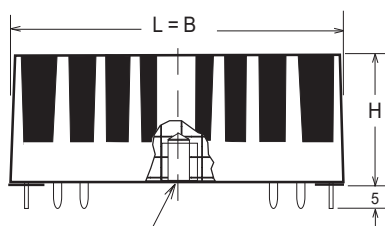

Blind insert M4 x 6 deep 1.6VA - 25VA
M5 Through hole 35VA - 50VA

Toroidal PC Transformers • 35VA - 160VA
Features

- Dual 115V or 230V, 50/60Hz Primary
- Lower strayfield
- High efficiency
- Reduced standby current
- Small size and low weight
- Extremely low level of radiated magnetic field
- Very low induced noise (hum)
- Very low iron loss
- Test Voltage Primary - Secondary 4.0 KV
- 100% electrical and flash tested
- Ambient operating temp.: +40°C Max.
- Insulation system recognized for Class A (105°C) meets all requirements of Class E (120°C)
- Manufactured in an ISO 9001:2015 and ISO 14001:2015 certified Talema facility
- Fully RoHS & REACH Compliant

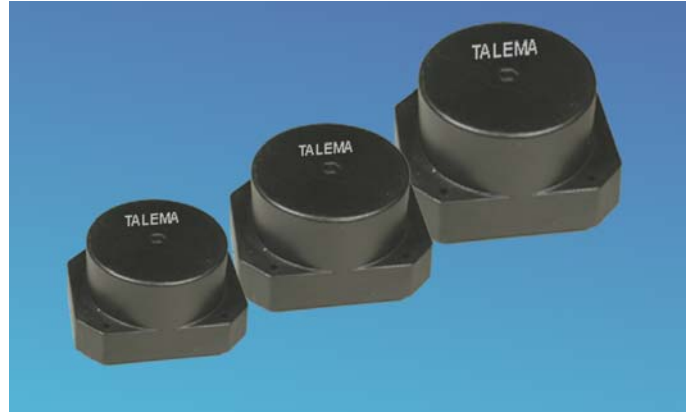
Standards

- High quality manufacturing and testing in accordance to EN61558, EN60065, EN60950, UL5085 & BS415

Standard Outputs (Electrical measurements @ 20°C ambient temperature)

Power VA	Part Number		Secondary Full Load V	Efficiency %	Regulation Delta Volts/sec @ 20°C	Schematic Primary - Secondary
	115V	230V				
35	6400K	6500K	2 x 7	83	18.6	
	6401K	6501K	2 x 9			
	6402K	6502K	2 x 12			
	6403K	6503K	2 x 15			
	6404K	6504K	2 x 18			
	6505K	6505K	2 x 24			
	6506K	6506K	2 x 30			
50	6410K	6510K	2 x 7	85	15.2	
	6411K	6511K	2 x 9			
	6412K	6512K	2 x 12			
	6413K	6513K	2 x 15			
	6414K	6514K	2 x 18			
	6415K	6515K	2 x 24			
	6416K	6516K	2 x 30			
90	6420K	6520K	2 X 7	89	11.5	
	6421K	6521K	2 X 9			
	6422K	6522K	2 X 12			
	6423K	6523K	2 X 15			
	6424K	6524K	2 X 18			
	6425K	6525K	2 X 24			
	6426K	6526K	2 X 30			

Note: 160VA only - Secondary pin connection for 2 x 7V will be 15+16, 18+19 and 24+25, 27+28

Toroidal PC Transformers • 35VA - 160VA

Power VA	Part Number		Secondary Full Load V	Efficiency %	Regulation Delta Volts/sec @ 20°C	Schematic Primary - Secondary
	115V	230V				
110	6430K	6530K	2 X 7	87	10.1	
	6431K	6531K	2 X 9			
	6432K	6532K	2 X 12			
	6433K	6533K	2 X 15			
	6434K	6534K	2 X 18			
	6435K	6535K	2 X 24			
	6436K	6536K	2 X 30			
160	6440K	6540K	2 X 7	90	9.5	
	6441K	6541K	2 X 9			
	6442K	6542K	2 X 12			
	6443K	6543K	2 X 15			
	6444K	6544K	2 X 18			
	6445K	6545K	2 X 24			
	6446K	6546K	2 X 30			

Pin Side

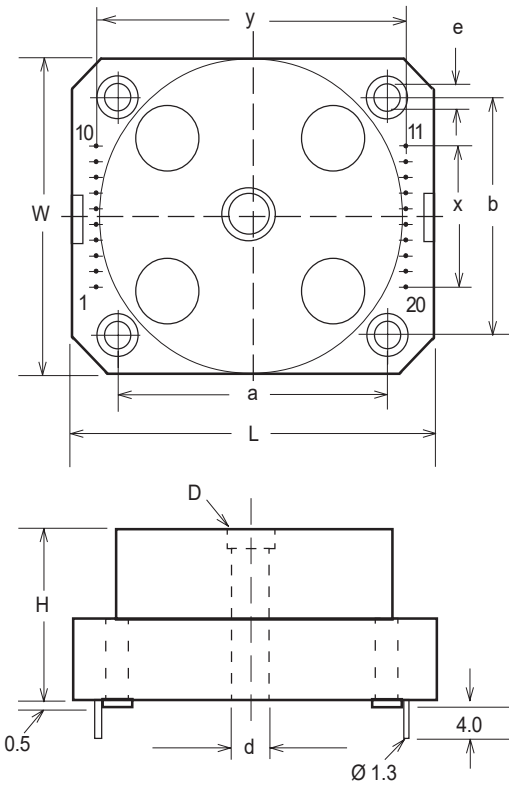

Options

- Dual primaries & multiple secondaries with different voltage ratings
- Magnetic and/or electrostatic shielding
- Fuses
- Temperature switches

Power VA	Dimensions - 6400K & 6500K Series										Weight kg
	L ±0.3	W ±0.2	H ±0.2	x ±0.2	y ±0.2	a ±0.2	b ±0.2	d ±0.2	e ±0.2	D (SW - Hex) ±0.2	
35	80.0	63.1	43.3	5x 5	70	50	50	5.1	3.4	7	0.72
50	90.2	73.2	43.4	7x 5	80	60	60	5.1	3.4	7	0.72
90	100.0	83.5	43.4	9x 5	90	70	70	5.1	3.4	7	1.00
110	112.2	93.3	50.5	11x 5	100	80	80	6.1	3.4	10	1.35
160	120.3	103.3	55.5	13 x 5	110	90	90	6.1	3.4	10	1.80

Regional Locations - Design, Manufacturing, Sales & Marketing

Talema Group Regional Offices

North America

United States (Sales & Marketing)

Talema Group, LLC
 PO Box 935
 900 Innovation Drive
 Suite 120, Rolla
 Missouri 65402
 Tel: +1 573-303-3675
 E-Mail:
sales@talemagroup.com
 Web: www.talema.com

Asia

India (Design, Manufacturing, Sales & Marketing)

Administrative Office
Talema Electronic India Private Limited
 Door No. 221, 1st and 2nd Floor
 KJ Plaza, Opp.to Vidya Mandir School
 Meyanoor Main Road
 Salem - 636 004 Tamil Nadu INDIA
 Tel: +91 427 - 243 3100
 Fax: +91 427 - 243 3109
 E-Mail: talema@talemaindia.net
 Web: www.talema.com

Factory Premises
Talema Electronic India Private Limited
 Plot Nos. 30, 31 Electrical and Electronic
 Industrial Estate
 Suramangalam
 Salem - 636 005 Tamil Nadu INDIA
 Tel: +91 427 - 243 3000
 E-Mail: talema@talemaindia.net
 Web: www.talema.com

Europe

Germany (Design, Sales & Marketing)

Talema Elektronik GmbH
 Sembdnerstr. 5
 82110 Germering
 Tel: +49 89 - 841 00 - 0
 Fax: +49 89 - 841 00 25
 E-Mail: info@talema.de
 Web: www.talema.com

Ireland (Design, Sales & Marketing)

Nuvotem TEO
 Units W & X, Gweedore Business Park
 Derrybeg, Letterkenny, Co. Donegal
 Tel: +353 (0) 74 95 48666
 Fax: +353 (0) 74 95 48139
 E-Mail: info@nuvotem.com
 Web: www.nuvotem.com

Czech Republic (Design, Manufacturing, Sales & Marketing)

NT Magnetics s.r.o.
 Chebská 27
 322 00 Plzeň
 Tel: +420 377 - 338 351
 Fax: +420 377 - 338 350
 E-Mail: talema@talema.cz
 Web: www.ntmagnetics.cz

Locations of Talema Group Regional Offices

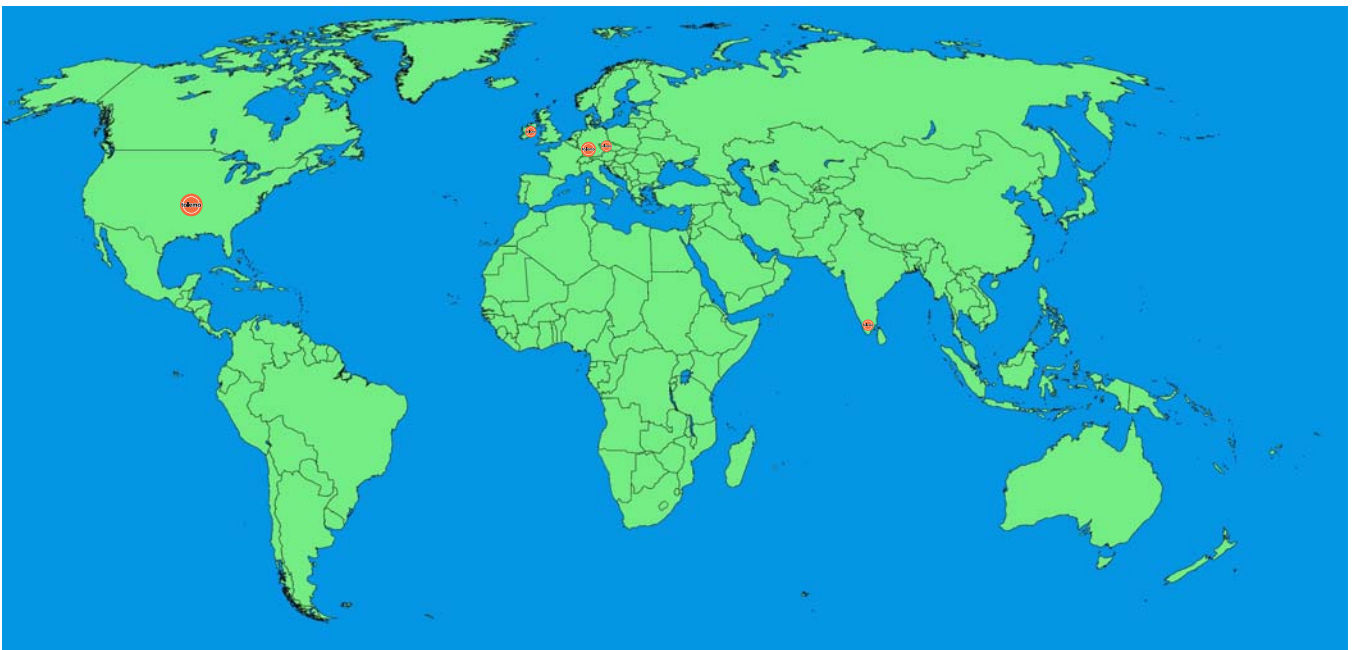

Summary TOTAL PROGRAM

SECTION 1

- TOROIDAL 50/60Hz TRANSFORMERS,
TOROIDAL PCB TRANSFORMERS &
MEDICAL GRADE ISOLATION TRANSFORMERS

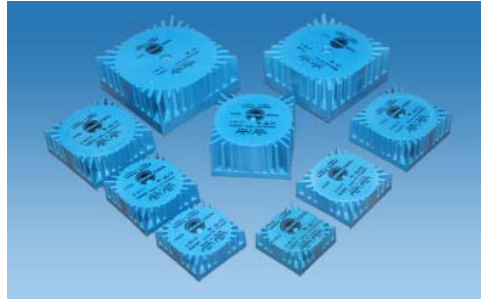

SECTION 2

- CURRENT SENSE TRANSFORMERS &
INDUCTORS

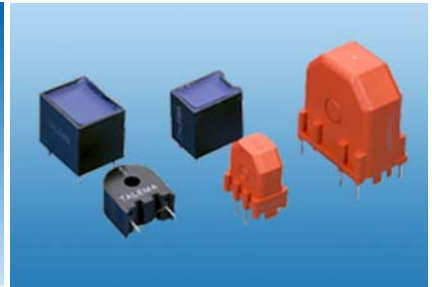
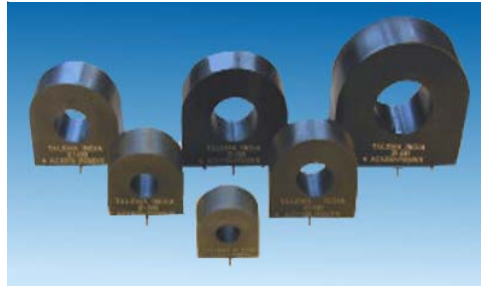

SECTION 3

- CHOKES, INDUCTORS AND TRANSFORMERS
FOR POWER APPLICATIONS



SECTION 4

- Transformers & Inductors FOR
SMPS MAGNETICS REQUIREMENTS

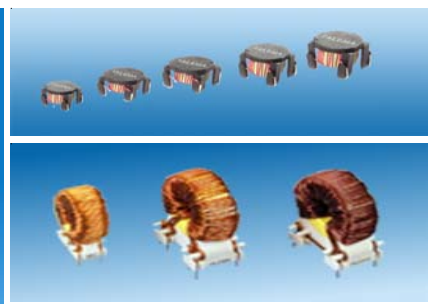

SECTION 5

- COMPONENTS FOR TELECOMMUNICATIONS
AND DATA LINE TECHNOLOGY

SECTION 6

- CURRENT COMPENSATED EMI NOISE
SUPPRESSION CHOKES



SECTION 7

- LAN MAGNETIC COMPONENTS FOR
ETHERNET APPLICATIONS

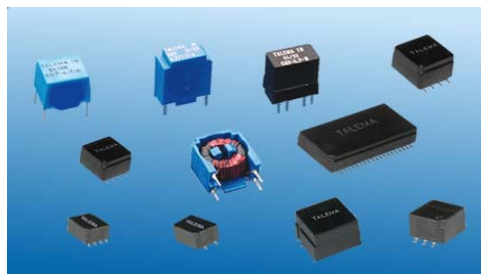

SECTION 8

- T1/E1/CEPT-PRI - T3/DS3/E3/STS-1 FOR
TELECOMMUNICATION PRODUCTS



SECTION 9

- TRANSFORMERS FOR BROADBAND ACCESS
AND FIBRE CHANNEL INTERFACE

SECTION 10

- THE TALEMA GROUP BROCHURE
OVERALL PRODUCTS - AN OVERVIEW

