

General Specifications

Electrical Capacity (Resistive Load)

Power Level (silver): 6A @ 125V AC or 3A @ 250V AC or 6A @ 12V DC for silver
Logic Level (gold): 0.4VA maximum @ 28V AC/DC maximum for gold
 (Applicable Range 0.1mA ~ 0.1A @ 20mV ~ 28V)
 Note: See Supplement Index for explanation of operating range.

Other Ratings

Contact Resistance: 10 milliohms maximum for silver; 20 milliohms maximum for gold
Insulation Resistance: 1,000 megohms minimum @ 500V DC
Dielectric Strength: 1,000V AC minimum between contacts for 1 minute minimum;
 1,500V AC minimum between contacts & case for 1 minute minimum
Mechanical Life: 50,000 operations minimum
Electrical Life: 25,000 operations minimum for silver; 50,000 operations minimum for gold
Static Capability: Withstands 20 kilovolts ESD minimum
Nominal Operating Force: 1.9N for .689" (17.5mm) toggle; 2.5N for .433" (11.0mm) toggle
Angle of Throw: 25°

Materials & Finishes

Toggle: Polycarbonate
Housing: Glass fiber reinforced polyamide
Sealing Ring: Nitrile butadiene rubber
Base: Diallyl phthalate (UL94V-0)
Movable Contactor: Phosphor bronze with silver or gold plating
Movable Contacts: Silver alloy or copper with gold plating
Stationary Contact: Silver plus copper with silver plating or copper with gold plating
Lamp Contacts: Beryllium copper with silver plating
Power Terminals: Copper with silver or gold plating
Lamp Terminals: Brass with silver plating

Environmental Data

Operating Temperature Range: -10°C through +55°C (+14°F through +131°F)
Humidity: 90 ~ 95% humidity for 240 hours @ 40°C (104°F)
Vibration: 10 ~ 55Hz with peak-to-peak amplitude of 1.5mm traversing the frequency range & returning in 1 minute; 3 right angled directions for 1.75 hours
Shock: 50G (490m/s²) acceleration (tested in 6 right angled directions, with 5 shocks in each direction)

Installation

Mounting Torque: .98Nm (8.67 lb•in) maximum
Soldering Time & Temperature: Manual Soldering: See Profile B in Supplement section.

Standards & Certifications

Flammability Standards: UL94V-0 base

Distinctive Characteristics

Choice of long or short toggles in translucent colors combine with bright LEDs available in red, amber, and green, plus super bright LEDs available in white, green, and blue.

Black face nut enhances front panel appearance.

Antistatic material used for toggle withstands 20 kilovolts electrostatic discharge.

Panel seal, achieved with use of optional exterior o-ring, conforms to IP65 of IEC 60529 Standards.

Interior o-ring protects contacts from oil, dust, water, and other contaminants.

UL94V-0 flammability rated for base.

High insulating barriers protect against crossover.

Terminals are molded in and epoxy sealed to lock out flux, dust, and other contaminants.

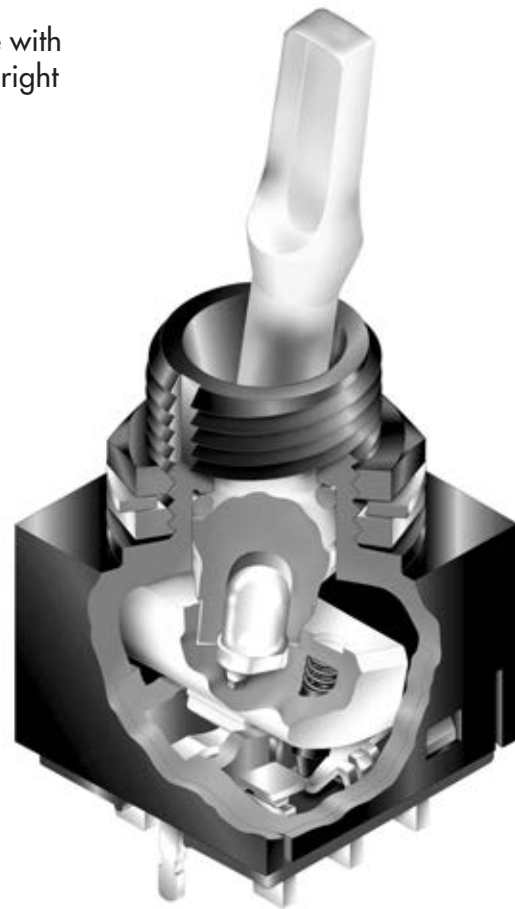

Actual Size



A

Toggles

Rockers

Pushbuttons

Illuminated PB

Programmable

Keylocks

Rotaries

Slides

Tactiles

Tilt

Touch

Indicators

Accessories

Supplement



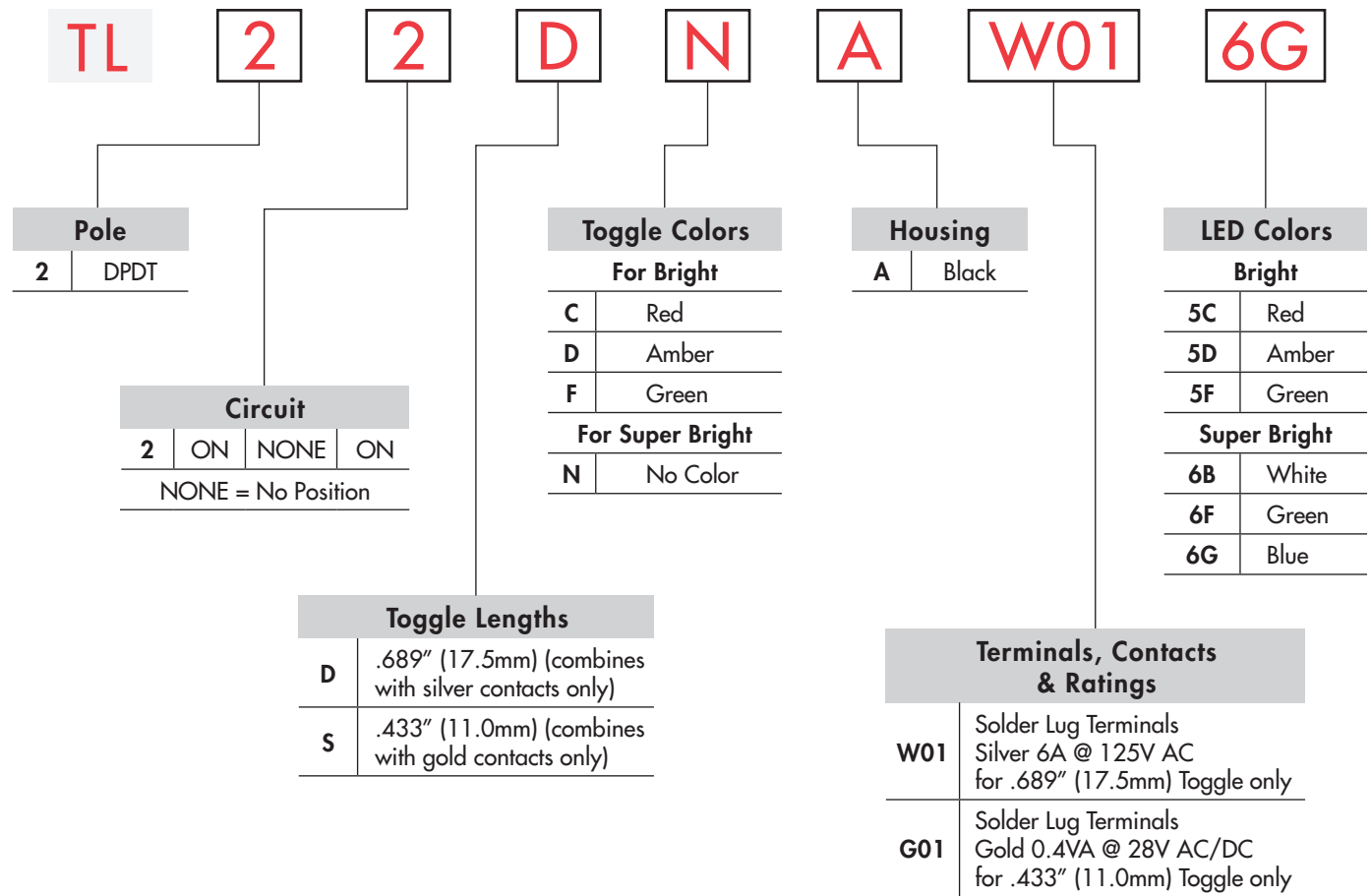

TYPICAL SWITCH ORDERING EXAMPLE



DESCRIPTION FOR TYPICAL ORDERING EXAMPLE

TL22DNAW016G



POLE & CIRCUIT								
Pole	Model	Toggle Position NONE = No Position			Connected Terminals			Throw & Power/Lamp Schematics
		Down 	Center	Up 	Down 	Center	Up 	
DP	TL22	ON	NONE	ON	1-1b 2-2b	OPEN	1-1a 2-2a	<p>Notes: Terminal numbers are on the switch. Lamp circuit is isolated and requires an external power source.</p> <p>DPDT</p> 

TOGGLE LENGTHS & COLORS

D .689" (17.5mm)

Combines with Silver Contacts only

Material: Polycarbonate

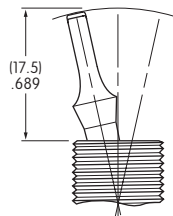

S .433" (11.0mm)

Combines with Gold Contacts only

Material: Polycarbonate

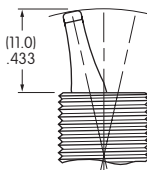

Colors Available for Bright LED

C Red **D** Amber **F** Green

Color Available for Super Bright LED

N No Color (Appearance is matte finish of clear material)

HOUSING

A **Black** The housing consists of the one-piece bushing/case of glass fiber reinforced polyamide in black color only.

The diallyl phthalate material used for the base is UL flammability rated 94V-0; housing material is not.

CONTACT MATERIALS, RATINGS, & TERMINALS

W **Silver Contacts** **Power Level**
6A @ 125V AC & 3A @ 250V AC
& 6A @ 12V DC

01 **Solder Lug Terminals**

G **Gold Contacts** **Logic Level**
0.4VA maximum @ 28V AC/DC

See Supplement Index for complete explanation of operating range.

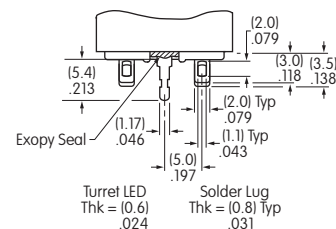

LED CODES & SPECIFICATIONS

Electrical specifications are determined at a basic temperature of 25°C. Lamp circuit is independent of switch operation.
 If the source voltage is greater than rated voltage, a ballast resistor is required.
 The ballast resistor calculation and more lamp detail are shown in Supplement section.

Super Bright LEDs are Electrostatic Sensitive		Colored Toggles			Clear Toggles			
		5 Bright			6 Super Bright			
LED Factory Assembled Not Available Separately	Color	C Red	D Amber	F Green	B White	F Green	G Blue	
	Maximum Forward Current	I_{FM}	30mA	30mA	50mA	30mA	30mA	30mA
	Typical Forward Current	I_F	20mA	20mA	20mA	20mA	20mA	
	Forward Voltage	V_F	2.05V	2.05V	2.27V	3.3V	3.3V	3.3V
	Maximum Reverse Voltage	V_{RM}	10V	10V	4V	7V	7V	7V
	Current Reduction Rate Above 25°C	ΔI_F	0.40mA/°C	0.40mA/°C	0.50mA/°C	0.40mA/°C	0.40mA/°C	0.40mA/°C
	Ambient Temperature Range		-10°C ~ +55°C			-10°C ~ +55°C		



TYPICAL SWITCH DIMENSIONS

17.5mm Toggle

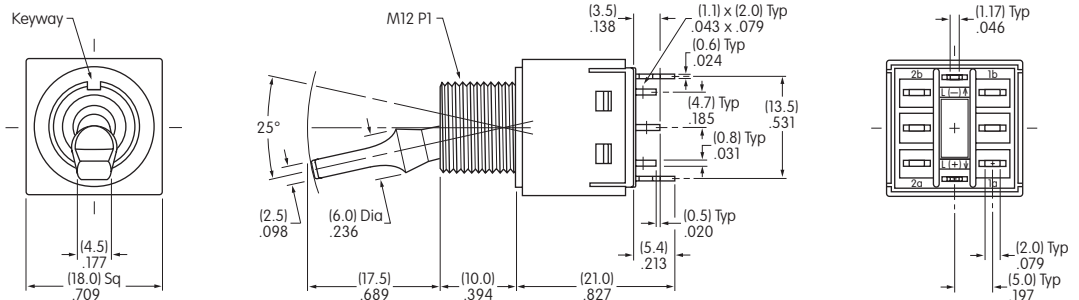

TL22DNAW016G

11.0mm Toggle

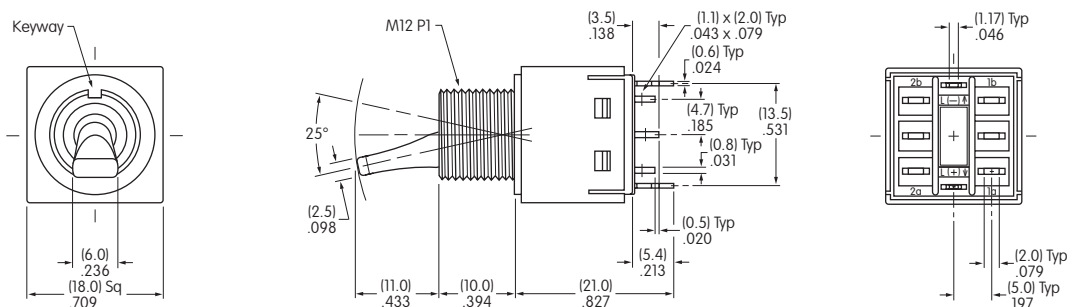

TL22SCAG015C

STANDARD HARDWARE

OPTIONAL HARDWARE

AT527MA Black Hex Nut

Use as Face Nut
Chrome/Steel

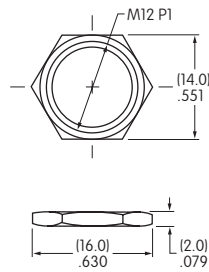

AT527M Hex Nut

Use as Backup Nut
Nickel/Steel

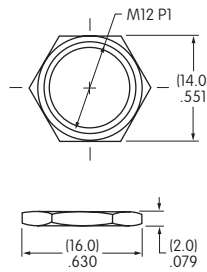

AT508 Lockwasher

Not to use with Panel Seal
Steel with Chromate/Zinc

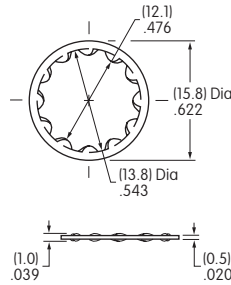

AT401P O-ring

Use for Panel Seal
Nitrile butadiene rubber

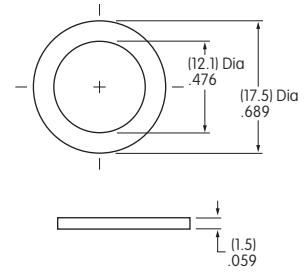

Hardware details in Accessories & Hardware section.

Panel Cutouts

Maximum Panel Thickness
with Standard Hardware:

.157" (4.0mm)

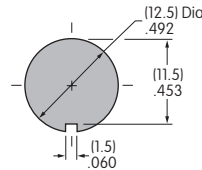
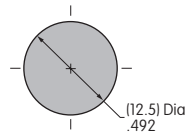

Maximum Panel Thickness
with Standard Hardware
& AT401P O-ring:

.236" (6.0mm)