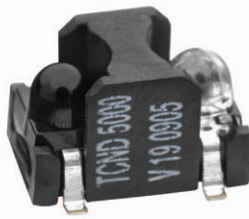
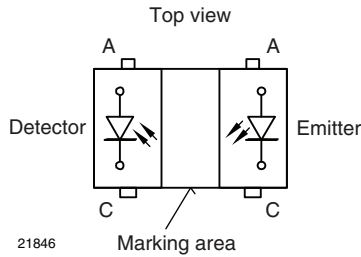


Reflective Optical Sensor with PIN Photodiode Output



19967



21846

DESCRIPTION

The TCND5000 is a reflective sensor that includes an infrared emitter and pin photodiode in a surface mount package which blocks visible light.

FEATURES

- Package type: surface mount
- Detector type: pin photodiode
- Dimensions (L x W x H in mm): 6 x 4.3 x 3.75
- Peak operating distance: 6 mm
- Operating range within > 20 % relative collector current: 2 mm to 25 mm
- Typical output current under test: $I_{ra} > 0.11 \mu\text{A}$
- Daylight blocking filter
- High linearity
- Emitter wavelength: 940 nm
- Lead (Pb)-free soldering released
- Moisture sensitivity level (MSL): 4
- Material categorization: for definitions of compliance please see www.vishay.com/doc?99912


RoHS
COMPLIANT

APPLICATIONS

- Proximity sensor
- Object sensor
- Motion sensor
- Touch key

PRODUCT SUMMARY				
PART NUMBER	DISTANCE FOR MAXIMUM CTR_{rel} ⁽¹⁾ (mm)	DISTANCE RANGE FOR RELATIVE $I_{\text{out}} > 20\%$ (mm)	TYPICAL OUTPUT CURRENT UNDER TEST ⁽²⁾ (mA)	DAYLIGHT BLOCKING FILTER INTEGRATED
TCND5000	6	2 to 25	0.0015	Yes

Notes

- (1) CTR: current transfer ratio, $I_{\text{out}}/I_{\text{in}}$
 (2) Conditions like in table basic characteristics/sensors

ORDERING INFORMATION			
ORDERING CODE	PACKAGING	VOLUME	REMARKS
TCND5000	Tape and reel	MOQ: 2000 pcs, 2000 pcs/reel	Drypack

Note

- MOQ: minimum order quantity

ABSOLUTE MAXIMUM RATINGS ($T_{\text{amb}} = 25^\circ\text{C}$, unless otherwise specified)				
PARAMETER	TEST CONDITION	SYMBOL	VALUE	UNIT
INPUT (EMITTER)				
Reverse voltage		V_R	5	V
Forward current		I_F	100	mA
Peak forward current	$t_p = 50 \mu\text{s}$, $t = 2 \text{ ms}$, $T_{\text{amb}} \leq 25^\circ\text{C}$	I_{FM}	500	mA
Power dissipation		P_V	190	mW
Junction temperature		T_j	100	$^\circ\text{C}$



ABSOLUTE MAXIMUM RATINGS ($T_{amb} = 25\text{ }^{\circ}\text{C}$, unless otherwise specified)				
PARAMETER	TEST CONDITION	SYMBOL	VALUE	UNIT
OUTPUT (DETECTOR)				
Reverse voltage		V_R	60	V
Power dissipation		P_V	75	mW
Junction temperature		T_j	100	$^{\circ}\text{C}$
SENSOR				
Ambient temperature range		T_{amb}	-40 to +85	$^{\circ}\text{C}$
Storage temperature range		T_{stg}	-40 to +100	$^{\circ}\text{C}$
Soldering temperature	acc. fig. 14	T_{sd}	260	$^{\circ}\text{C}$

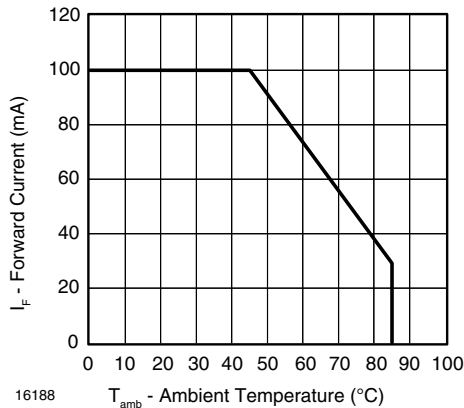


Fig. 1 - Forward Current Limit vs. Ambient Temperature

BASIC CHARACTERISTICS ($T_{amb} = 25\text{ }^{\circ}\text{C}$, unless otherwise specified)						
PARAMETER	TEST CONDITION	SYMBOL	MIN.	TYP.	MAX.	UNIT
INPUT (EMITTER) ⁽¹⁾						
Forward voltage	$I_F = 50\text{ mA}$, $t_p = 20\text{ ms}$	V_F		1.2	1.5	V
Temperature coefficient of V_F	$I_F = 1\text{ mA}$	TK_{V_F}		-1.3		mV/K
Reverse current	$V_R = 5\text{ V}$	I_R			10	μA
Junction capacitance	$V_R = 0\text{ V}$, $f = 1\text{ MHz}$, $E = 0\text{ lx}$	C_j		40		pF
Radiant intensity	$I_F = 20\text{ mA}$, $t_p = 20\text{ ms}$	I_e		11	15	mW/sr
Angle of half intensity		ϕ		± 12		deg
Peak wavelength	$I_F = 100\text{ mA}$	λ_p	930	940		nm
Spectral bandwidth	$I_F = 100\text{ mA}$	$\Delta\lambda$		30		nm
Temperature coefficient of λ_p	$I_F = 100\text{ mA}$	TK_{λ_p}		0.2		nm/K
Rise time	$I_F = 100\text{ mA}$	t_r		15		ns
Fall time	$I_F = 100\text{ mA}$	t_f		15		ns

BASIC CHARACTERISTICS ($T_{amb} = 25\text{ }^{\circ}\text{C}$, unless otherwise specified)						
PARAMETER	TEST CONDITION	SYMBOL	MIN.	TYP.	MAX.	UNIT
OUTPUT (DETECTOR) ⁽²⁾						
Forward voltage	$I_F = 50\text{ mA}$	V_F		1	1.3	V
Breakdown voltage	$I_R = 100\text{ }\mu\text{A}$	V_{BR}	60			V
Reverse dark current	$V_R = 10\text{ V}$, $E = 0\text{ lx}$	I_{ro}		1	10	nA
Diode capacitance	$V_R = 5\text{ V}$, $f = 1\text{ MHz}$, $E = 0\text{ lx}$	C_D		1.8		pF
Reverse light current	$E_e = 1\text{ mW/cm}^2$, $\lambda = 950\text{ nm}$, $V_R = 5\text{ V}$	I_{ra}		12		μA
Temperature coefficient of I_{ra}	$\lambda = 870\text{ nm}$, $V_R = 5\text{ V}$	TK_{Ira}		0.2		%/K
Angle of half intensity		φ		± 15		deg
Wavelength of peak sensitivity		λ_p		930		nm
Range of spectral bandwidth		$\lambda_{0.5}$		840 to 1050		nm
SENSOR						
Reverse Light Current	$V_R = 2.5\text{ V}$, $I_F = 20\text{ mA}$, $D = 30\text{ mm}$, reflective mode: see figure 2	I_{ra}	110	260		nA

Notes

- (1) See figures 2 to 8 accordingly
 (2) See figures 9 to 12 accordingly

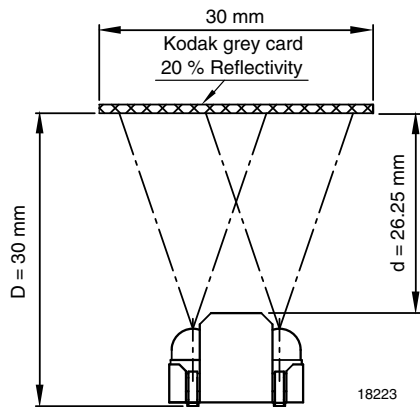


Fig. 2 - Test Circuit

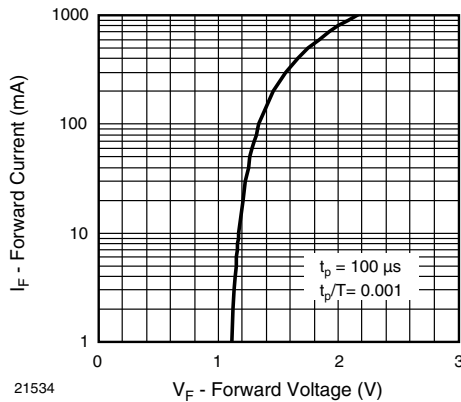
BASIC CHARACTERISTICS ($T_{amb} = 25\text{ }^{\circ}\text{C}$, unless otherwise specified)


Fig. 3 - Forward Current vs. Forward Voltage

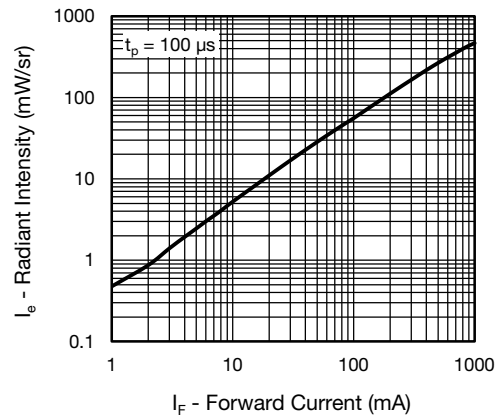


Fig. 4 - Radiant Intensity vs. Forward Current

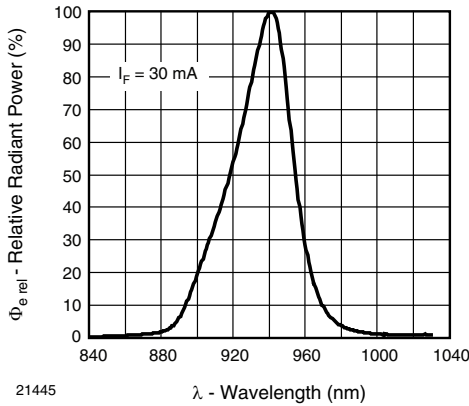


Fig. 5 - Relative Radiant Power vs. Wavelength

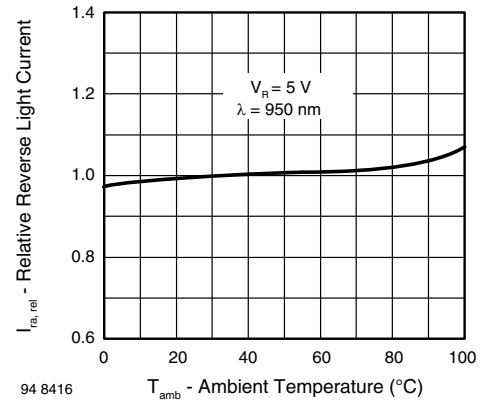


Fig. 8 - Relative Reverse Light Current vs. Ambient Temperature

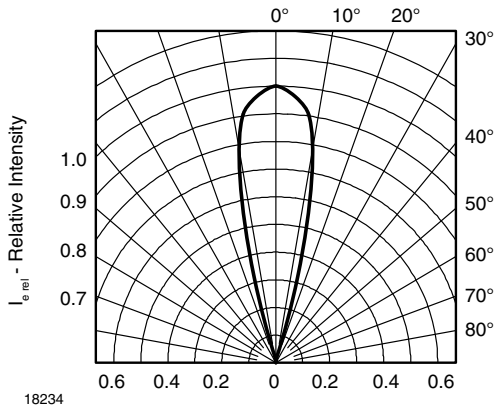


Fig. 6 - Relative Radiant Intensity vs. Angular Displacement

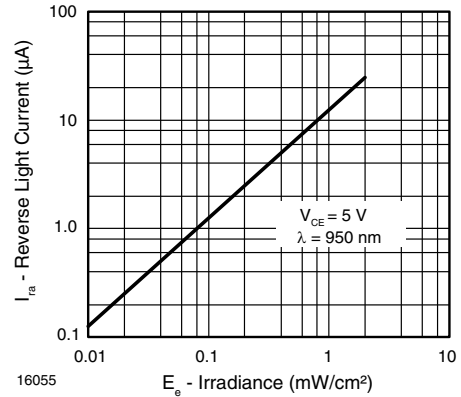


Fig. 9 - Reverse Light Current vs. Irradiance

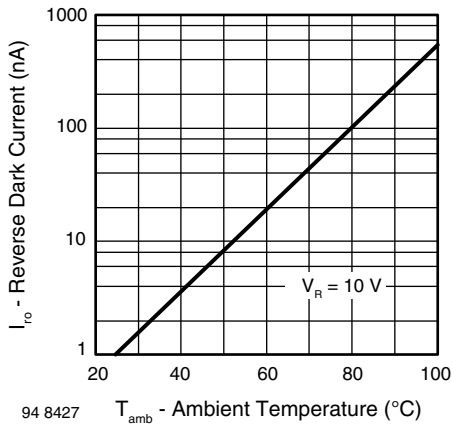


Fig. 7 - Reverse Dark Current vs. Ambient Temperature

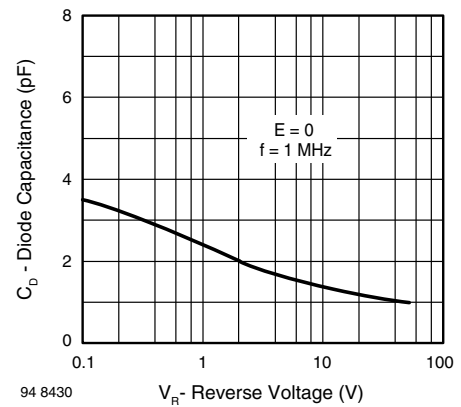


Fig. 10 - Diode Capacitance vs. Reverse Voltage

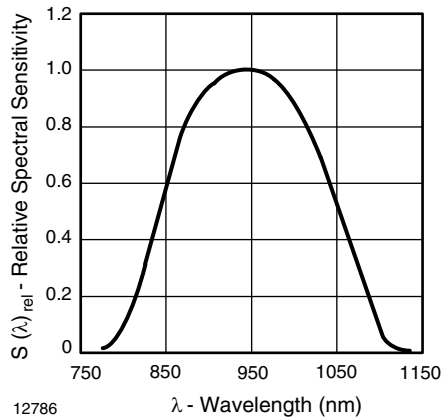


Fig. 11 - Relative Spectral Sensitivity vs. Wavelength

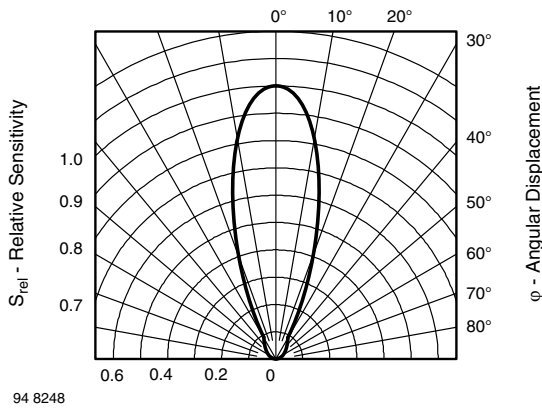


Fig. 12 - Relative Radiant Sensitivity vs. Angular Displacement

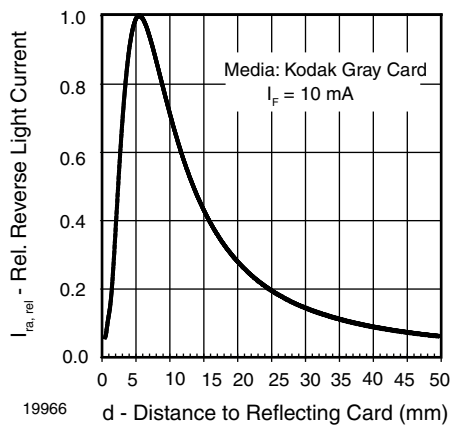
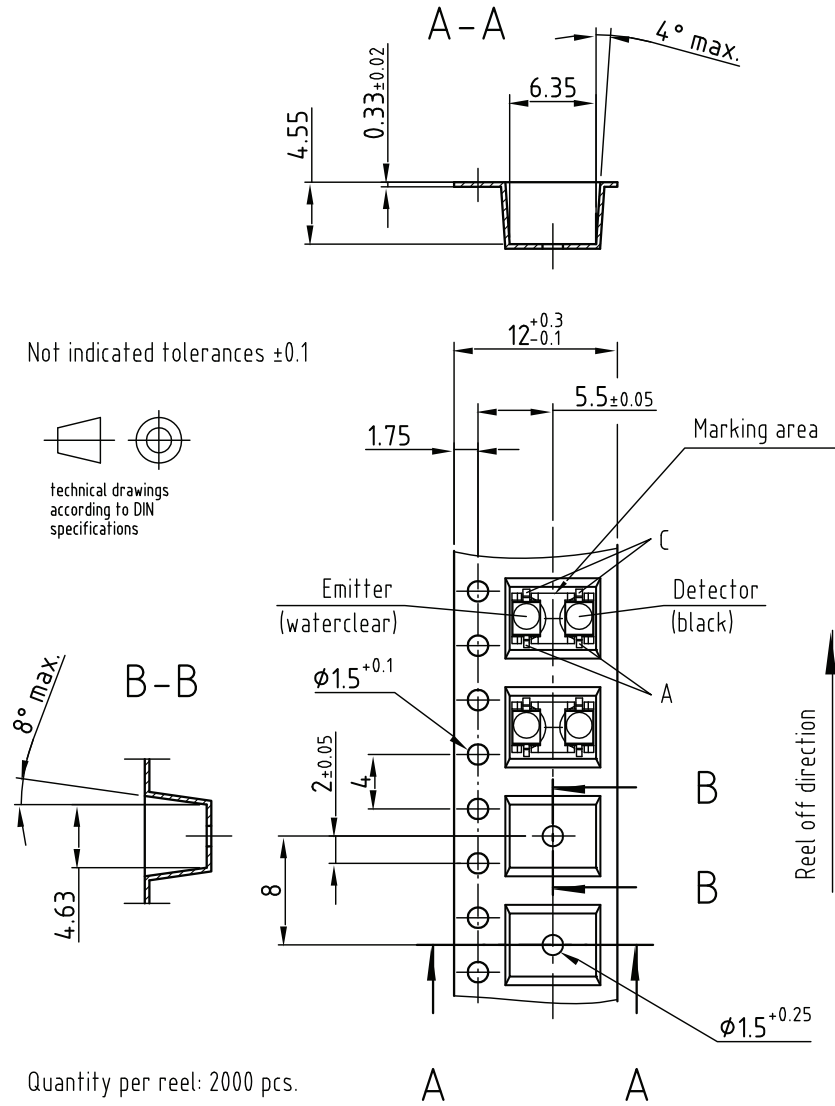


Fig. 13 - Relative Reverse Light Current vs. Distance



TAPING DIMENSIONS in millimeters



Not indicated tolerances ±0.1

technical drawings according to DIN specifications

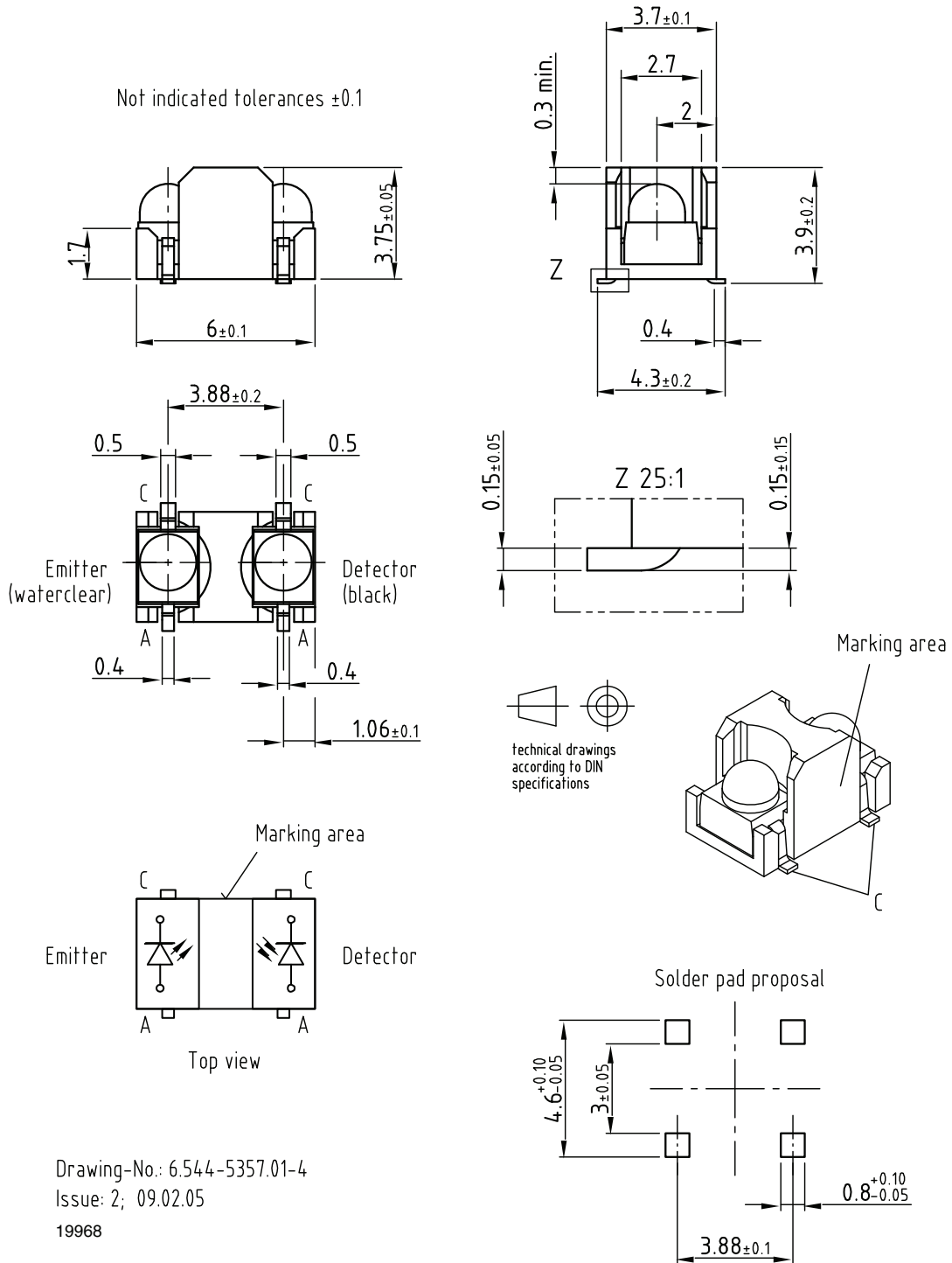
Quantity per reel: 2000 pcs.

Material of Blistertape: PC black
Sealing of cavities with hot sealing cover tape,
C-Pak Type CP - 2010 AS (Thickness: 0.055 - 0.075mm; Base Material: Polyester)

Drawing-No.: 9.700-5281.01-4
Issue: 4; 10.02.05
18222

PACKAGE DIMENSIONS in millimeters

Not indicated tolerances ± 0.1



Drawing-No.: 6.544-5357.01-4

Issue: 2; 09.02.05

19968

PRECAUTIONS FOR USE

1. Over-current-proof

Customer must apply resistors for protection, otherwise slight voltage shift will cause big current change (Burn out will happen).

2. Storage

2.1 Storage temperature and rel. humidity conditions are: 5 °C to 30 °C, RH 60 %

2.2 Floor life must not exceed 72 h, acc. to JEDEC® level 4, J-STD-020.

Once the package is opened, the products should be used within 72 h. Otherwise, they should be kept in a damp proof box with desiccant.

Considering tape life, we suggest to use products within one year from production date.

2.3 If opened more than 72 h in an atmosphere 5 °C to 30 °C, RH 60 %, devices should be treated at 60 °C ± 5 °C for 15 h.

2.4 If humidity indicator in the package shows pink color (normal blue), then devices should be treated with the same conditions as 2.3

REFLOW SOLDER PROFILES

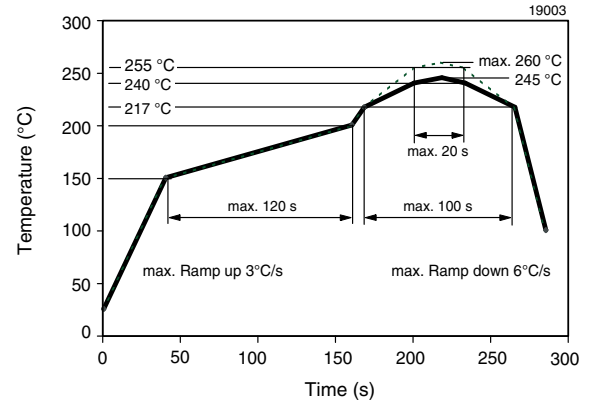


Fig. 14 - Lead (Pb)-Free Reflow Solder Profile

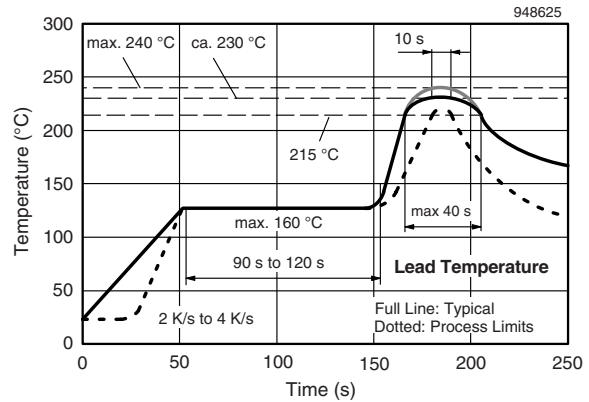


Fig. 15 - Lead Tin (SnPb) Reflow Solder Profile



Disclaimer

ALL PRODUCT, PRODUCT SPECIFICATIONS AND DATA ARE SUBJECT TO CHANGE WITHOUT NOTICE TO IMPROVE RELIABILITY, FUNCTION OR DESIGN OR OTHERWISE.

Vishay Intertechnology, Inc., its affiliates, agents, and employees, and all persons acting on its or their behalf (collectively, "Vishay"), disclaim any and all liability for any errors, inaccuracies or incompleteness contained in any datasheet or in any other disclosure relating to any product.

Vishay makes no warranty, representation or guarantee regarding the suitability of the products for any particular purpose or the continuing production of any product. To the maximum extent permitted by applicable law, Vishay disclaims (i) any and all liability arising out of the application or use of any product, (ii) any and all liability, including without limitation special, consequential or incidental damages, and (iii) any and all implied warranties, including warranties of fitness for particular purpose, non-infringement and merchantability.

Statements regarding the suitability of products for certain types of applications are based on Vishay's knowledge of typical requirements that are often placed on Vishay products in generic applications. Such statements are not binding statements about the suitability of products for a particular application. It is the customer's responsibility to validate that a particular product with the properties described in the product specification is suitable for use in a particular application. Parameters provided in datasheets and / or specifications may vary in different applications and performance may vary over time. All operating parameters, including typical parameters, must be validated for each customer application by the customer's technical experts. Product specifications do not expand or otherwise modify Vishay's terms and conditions of purchase, including but not limited to the warranty expressed therein.

Hyperlinks included in this datasheet may direct users to third-party websites. These links are provided as a convenience and for informational purposes only. Inclusion of these hyperlinks does not constitute an endorsement or an approval by Vishay of any of the products, services or opinions of the corporation, organization or individual associated with the third-party website. Vishay disclaims any and all liability and bears no responsibility for the accuracy, legality or content of the third-party website or for that of subsequent links.

Vishay products are not designed for use in life-saving or life-sustaining applications or any application in which the failure of the Vishay product could result in personal injury or death unless specifically qualified in writing by Vishay. Customers using or selling Vishay products not expressly indicated for use in such applications do so at their own risk. Please contact authorized Vishay personnel to obtain written terms and conditions regarding products designed for such applications.

No license, express or implied, by estoppel or otherwise, to any intellectual property rights is granted by this document or by any conduct of Vishay. Product names and markings noted herein may be trademarks of their respective owners.