

Transmissive Optical Sensor with Phototransistor Output

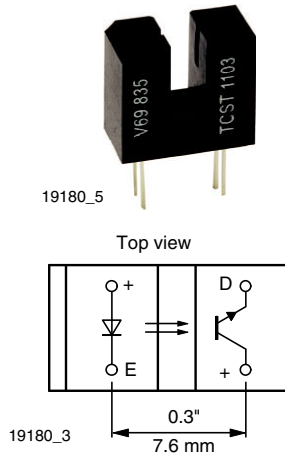

FEATURES

- Package type: leaded
- Detector type: phototransistor
- Dimensions (L x W x H in mm): 11.9 x 6.3 x 10.8
- Gap (in mm): 3.1
- Typical output current under test: $I_C = 4$ mA (TCST1103)
- Typical output current under test: $I_C = 2$ mA (TCST1202)
- Typical output current under test: $I_C = 0.5$ mA (TCST1300)
- Daylight blocking filter
- Emitter wavelength: 950 nm
- Lead (Pb)-free soldering released
- Compliant to RoHS Directive 2002/95/EC and in accordance to WEEE 2002/96/EC

RoHS
COMPLIANT

DESCRIPTION

The TCST1103, TCST1202, and TCST1300 are transmissive sensors that include an infrared emitter and phototransistor, located face-to-face on the optical axes in a leaded package which blocks visible light. These part numbers include options for aperture width.

APPLICATIONS

- Optical switch
- Photo interrupter
- Counter
- Encoder

| PRODUCT SUMMARY | | | | |
|-----------------|----------------|---------------------|---|-------------------------------------|
| PART NUMBER | GAP WIDTH (mm) | APERTURE WIDTH (mm) | TYPICAL OUTPUT CURRENT UNDER TEST ⁽¹⁾ (mA) | DAYLIGHT BLOCKING FILTER INTEGRATED |
| TCST1103 | 3.1 | 1 | 4 | Yes |
| TCST1202 | 3.1 | 0.5 | 2 | Yes |
| TCST1300 | 3.1 | 0.25 | 0.5 | Yes |

Note

- Conditions like in table basic characteristics/coupler

| ORDERING INFORMATION | | | |
|----------------------|-----------|----------------------------|-------------------------|
| ORDERING CODE | PACKAGING | VOLUME ⁽¹⁾ | REMARKS |
| TCST1103 | Tube | MOQ: 1020 pcs, 85 pcs/tube | Without mounting flange |
| TCST1202 | Tube | MOQ: 1020 pcs, 85 pcs/tube | Without mounting flange |
| TCST1300 | Tube | MOQ: 1020 pcs, 85 pcs/tube | Without mounting flange |

Note

- MOQ: minimum order quantity

| ABSOLUTE MAXIMUM RATINGS ($T_{amb} = 25$ °C, unless otherwise specified) | | | | |
|---|---|-----------|---------------|------|
| PARAMETER | TEST CONDITION | SYMBOL | VALUE | UNIT |
| COUPLER | | | | |
| Total power dissipation | $T_{amb} \leq 25$ °C | P_{tot} | 250 | mW |
| Ambient temperature range | | T_{amb} | - 55 to + 85 | °C |
| Storage temperature range | | T_{stg} | - 55 to + 100 | °C |
| Soldering temperature | Distance to package: 2 mm; $t \leq 5$ s | T_{sd} | 260 | °C |



| ABSOLUTE MAXIMUM RATINGS ($T_{amb} = 25\text{ }^{\circ}\text{C}$, unless otherwise specified) | | | | |
|---|---|-----------|-------|--------------------|
| PARAMETER | TEST CONDITION | SYMBOL | VALUE | UNIT |
| INPUT (EMITTER) | | | | |
| Reverse voltage | | V_R | 6 | V |
| Forward current | | I_F | 60 | mA |
| Forward surge current | $t_p \leq 10\text{ }\mu\text{s}$ | I_{FSM} | 3 | A |
| Power dissipation | $T_{amb} \leq 25\text{ }^{\circ}\text{C}$ | P_V | 100 | mW |
| Junction temperature | | T_j | 100 | $^{\circ}\text{C}$ |
| OUTPUT (DETECTOR) | | | | |
| Collector emitter voltage | | V_{CEO} | 70 | V |
| Emitter collector voltage | | V_{ECO} | 7 | V |
| Collector peak current | $t_p/T = 0.5, t_p \leq 10\text{ ms}$ | I_{CM} | 200 | mA |
| Power dissipation | $T_{amb} \leq 25\text{ }^{\circ}\text{C}$ | P_V | 150 | mW |
| Junction temperature | | T_j | 100 | $^{\circ}\text{C}$ |

ABSOLUTE MAXIMUM RATINGS

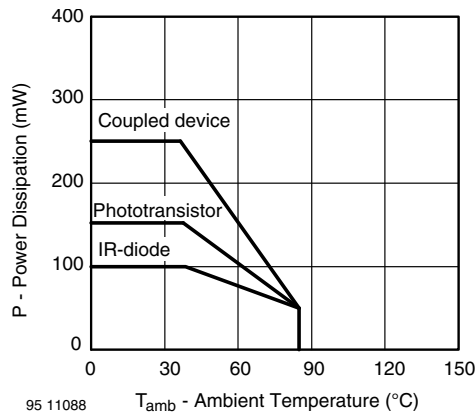

Fig. 1 - Power Dissipation Limit vs. Ambient Temperature

| BASIC CHARACTERISTICS ($T_{amb} = 25\text{ }^{\circ}\text{C}$, unless otherwise specified) | | | | | | | |
|--|---|----------|-------------|------|------|------|------|
| PARAMETER | TEST CONDITION | PART | SYMBOL | MIN. | TYP. | MAX. | UNIT |
| COUPLER | | | | | | | |
| Current transfer ratio | $V_{CE} = 5\text{ V}, I_F = 20\text{ mA}$ | TCST1103 | CTR | 10 | 20 | | % |
| | | TCST1202 | CTR | 5 | 10 | | % |
| | | TCST1300 | CTR | 1.25 | 2.5 | | % |
| Collector current | $V_{CE} = 5\text{ V}, I_F = 20\text{ mA}$ | TCST1103 | I_C | 2 | 4 | | mA |
| | | TCST1202 | I_C | 1 | 2 | | mA |
| | | TCST1300 | I_C | 0.25 | 0.5 | | mA |
| Collector emitter saturation voltage | $I_F = 20\text{ mA}, I_C = 1\text{ mA}$ | TCST1103 | V_{CEsat} | | | 0.4 | V |
| | $I_F = 20\text{ mA}, I_C = 0.5\text{ mA}$ | TCST1202 | V_{CEsat} | | | 0.4 | V |
| | $I_F = 20\text{ mA}, I_C = 0.1\text{ mA}$ | TCST1300 | V_{CEsat} | | | 0.4 | V |
| Resolution, path of the shutter crossing the radiant sensitive zone | $I_{Crel} = 10\text{ \% to }90\text{ \%}$ | TCST1103 | s | | 0.6 | | mm |
| | | TCST1202 | s | | 0.4 | | mm |
| | | TCST1300 | s | | 0.2 | | mm |

| BASIC CHARACTERISTICS ($T_{amb} = 25\text{ }^{\circ}\text{C}$, unless otherwise specified) | | | | | | | |
|--|--|------|-----------|------|------|------|---------------|
| PARAMETER | TEST CONDITION | PART | SYMBOL | MIN. | TYP. | MAX. | UNIT |
| INPUT (EMITTER) | | | | | | | |
| Forward voltage | $I_F = 60\text{ mA}$ | | V_F | | 1.25 | 1.6 | V |
| Junction capacitance | $V_R = 0\text{ V}$, $f = 1\text{ MHz}$ | | C_j | | 50 | | pF |
| OUTPUT (DETECTOR) | | | | | | | |
| Collector emitter voltage | $I_C = 1\text{ mA}$ | | V_{CEO} | 70 | | | V |
| Emitter collector voltage | $I_E = 10\text{ }\mu\text{A}$ | | V_{ECO} | 7 | | | V |
| Collector dark current | $V_{CE} = 25\text{ V}$, $I_F = 0\text{ A}$, $E = 0\text{ lx}$ | | I_{CEO} | | | 100 | nA |
| SWITCHING CHARACTERISTICS | | | | | | | |
| Turn-on time | $I_C = 2\text{ mA}$, $V_S = 5\text{ V}$, $R_L = 100\text{ }\Omega$ (see figure 2) | | t_{on} | | 10 | | μs |
| Turn-off time | $I_C = 2\text{ mA}$, $V_S = 5\text{ V}$, $R_L = 100\text{ }\Omega$ (see figure 2) | | t_{off} | | 8 | | μs |

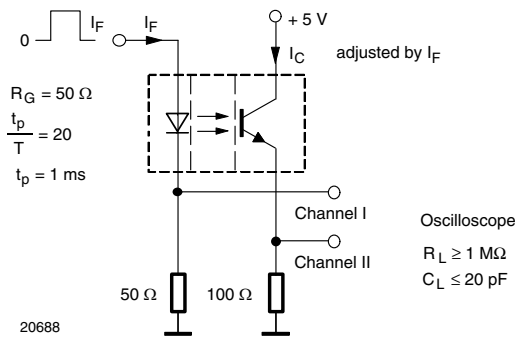

 Fig. 2 - Test Circuit for t_{on} and t_{off}

Fig. 3 - Switching Times

BASIC CHARACTERISTICS ($T_{amb} = 25\text{ }^{\circ}\text{C}$, unless otherwise specified)

Fig. 4 - Forward Current vs. Forward Voltage

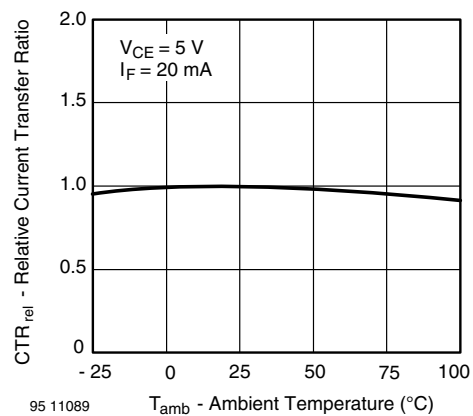

Fig. 5 - Relative Current Transfer Ratio vs. Ambient Temperature

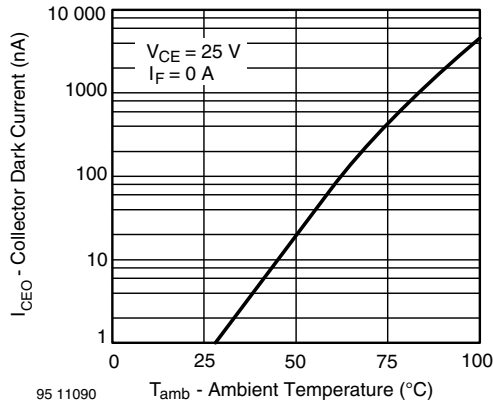

Fig. 6 - Collector Dark Current vs. Ambient Temperature



Fig. 9 - Current Transfer Ratio vs. Forward Current

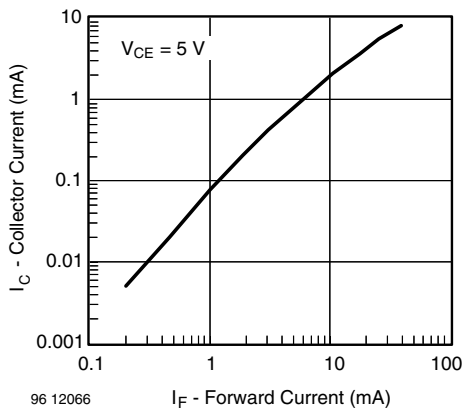

Fig. 7 - Collector Current vs. Forward Current

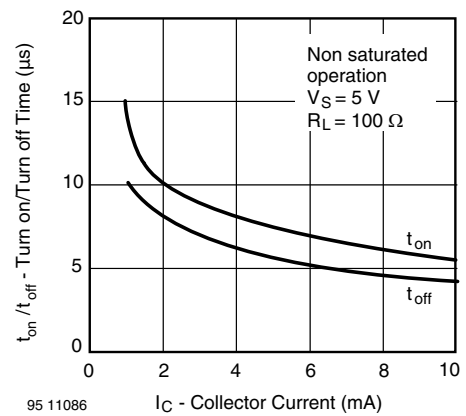

Fig. 10 - Turn-off/Turn-on Time vs. Collector Current

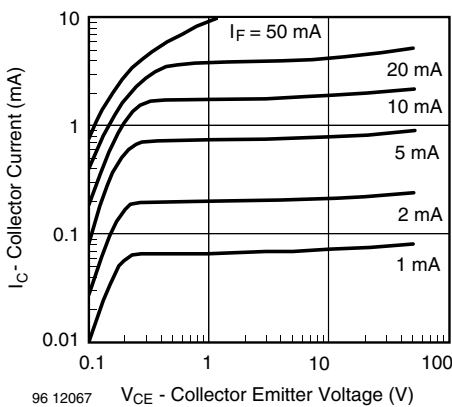

Fig. 8 - Collector Current vs. Collector Emitter Voltage

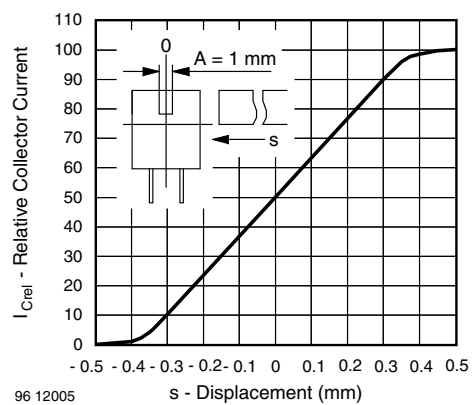

Fig. 11 - Relative Collector Current vs. Displacement

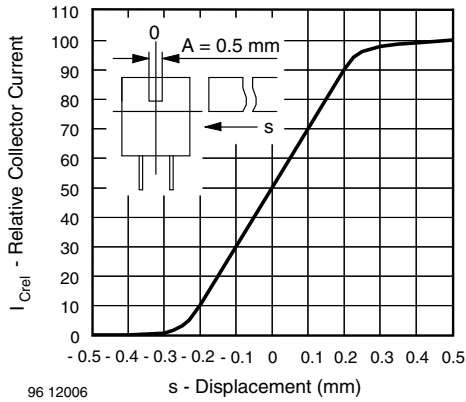

Fig. 12 - Relative Collector Current vs. Displacement

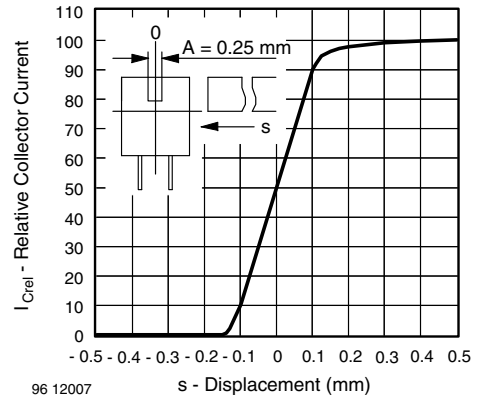
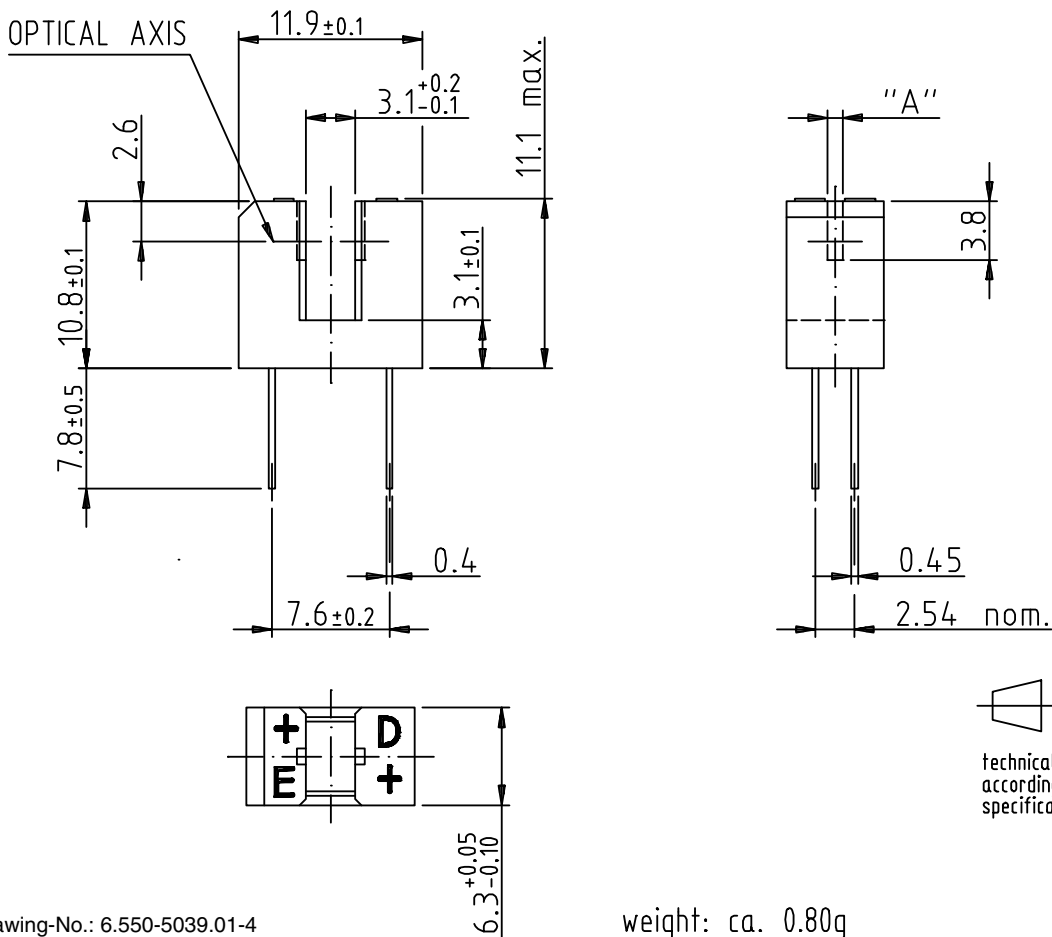

Fig. 13 - Relative Collector Current vs. Displacement

PACKAGE DIMENSIONS in millimeters



Drawing-No.: 6.550-5039.01-4

Issue: 2; 10.11.98

96 12094

weight: ca. 0.80g



TUBE DIMENSIONS in millimeters



With rubber stopper
Tolerance: $\pm 0.5\text{mm}$
Length: $575 \pm 1\text{mm}$

Drawing-No.: 9.700-5100.01-4

Issue: 1; 25.02.00

20252



Disclaimer

ALL PRODUCT, PRODUCT SPECIFICATIONS AND DATA ARE SUBJECT TO CHANGE WITHOUT NOTICE TO IMPROVE RELIABILITY, FUNCTION OR DESIGN OR OTHERWISE.

Vishay Intertechnology, Inc., its affiliates, agents, and employees, and all persons acting on its or their behalf (collectively, "Vishay"), disclaim any and all liability for any errors, inaccuracies or incompleteness contained in any datasheet or in any other disclosure relating to any product.

Vishay makes no warranty, representation or guarantee regarding the suitability of the products for any particular purpose or the continuing production of any product. To the maximum extent permitted by applicable law, Vishay disclaims (i) any and all liability arising out of the application or use of any product, (ii) any and all liability, including without limitation special, consequential or incidental damages, and (iii) any and all implied warranties, including warranties of fitness for particular purpose, non-infringement and merchantability.

Statements regarding the suitability of products for certain types of applications are based on Vishay's knowledge of typical requirements that are often placed on Vishay products in generic applications. Such statements are not binding statements about the suitability of products for a particular application. It is the customer's responsibility to validate that a particular product with the properties described in the product specification is suitable for use in a particular application. Parameters provided in datasheets and / or specifications may vary in different applications and performance may vary over time. All operating parameters, including typical parameters, must be validated for each customer application by the customer's technical experts. Product specifications do not expand or otherwise modify Vishay's terms and conditions of purchase, including but not limited to the warranty expressed therein.

Hyperlinks included in this datasheet may direct users to third-party websites. These links are provided as a convenience and for informational purposes only. Inclusion of these hyperlinks does not constitute an endorsement or an approval by Vishay of any of the products, services or opinions of the corporation, organization or individual associated with the third-party website. Vishay disclaims any and all liability and bears no responsibility for the accuracy, legality or content of the third-party website or for that of subsequent links.

Vishay products are not designed for use in life-saving or life-sustaining applications or any application in which the failure of the Vishay product could result in personal injury or death unless specifically qualified in writing by Vishay. Customers using or selling Vishay products not expressly indicated for use in such applications do so at their own risk. Please contact authorized Vishay personnel to obtain written terms and conditions regarding products designed for such applications.

No license, express or implied, by estoppel or otherwise, to any intellectual property rights is granted by this document or by any conduct of Vishay. Product names and markings noted herein may be trademarks of their respective owners.