



BICMOS MIXER W/ INTEGRATED LO AMPLIFIER, 700 - 1100MHz

Typical Applications

The HMC786LP4E is Ideal for:

- Cellular/3G & LTE/WiMAX/4G
- Basestations & Repeaters
- GSM, CDMA & OFDM
- Transmitters and Receivers

Features

- High Input IP3: +38 dBm
- 7.5 dB Conversion Loss @ 0 dBm LO
- Optimized for High Side LO Input
- 24 Lead 4x4mm SMT Package: 16mm²

Functional Diagram

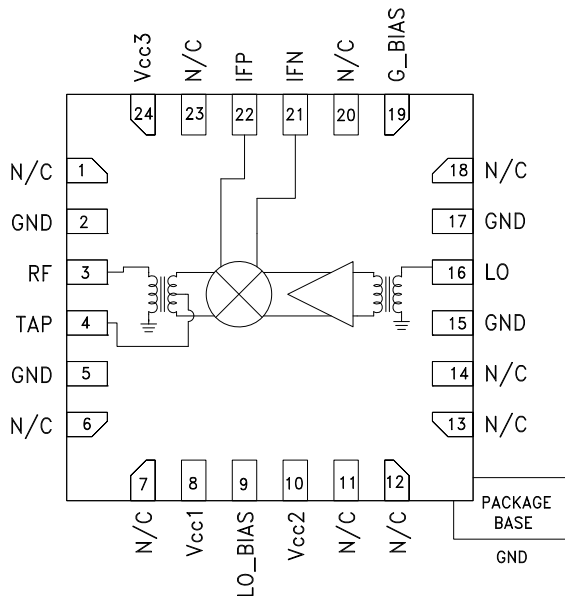

General Description

The HMC786LP4E is a high dynamic range passive MMIC mixer with integrated LO amplifier in a 4x4 SMT QFN package covering 0.7 to 1.1 GHz. Excellent input IP3 performance of +40 dBm for down conversion is provided for 3G & 4G GSM/CDMA applications at an LO drive of 0 dBm. With an input 1 dB compression of +25 dBm, the RF port will accept a wide range of input signal levels. Conversion loss is 7.5 dB typical. Up to 250 MHz IF frequency response will satisfy GSM/CDMA transmit or receive frequency plans. The HMC786LP4E is optimized for high side LO frequency plans for 0.7 - 1.1 GHz RF Band and is pin for pin compatible with the HMC686LP4E

Downconverter Electrical Specifications,

$T_A = +25^\circ C$, LO = 0 dBm, Vcc = Vcc1, 2, 3 = +5V, G_Bias = +2.5V *

| Parameter | Min. | Typ. | Max. | Min. | Typ. | Max. | Units |
|--------------------------------|------|-------------|------|------|---------------|------|-------|
| Frequency Range, RF | | 0.7 - 1.1 | | | 0.824 - 0.915 | | GHz |
| Frequency Range, LO | | 0.75 - 1.35 | | | 0.974 - 1.065 | | GHz |
| Frequency Range, IF | | 50 - 250 | | | 150 | | MHz |
| Conversion Loss | | 7.5 | 9.5 | | 7.5 | 9.5 | dB |
| Noise Figure (SSB) | | 7.5 | | | 7.5 | | dB |
| IP3 (Input) | | 36 | | | 38 | | dBm |
| 1 dB Compression (Input) | | 26 | | | 27 | | dBm |
| LO to RF Isolation | 18 | 24 | | 18 | 23 | | dB |
| LO to IF Isolation | 23 | 30 | | 23 | 30 | | dB |
| RF to IF Isolation | 25 | 39 | | 30 | 40 | | dB |
| LO Drive Input Level (Typical) | | -1 to +6 | | | -1 to +6 | | dBm |
| Supply Current (Icc total) | 120 | 130 | 140 | 120 | 130 | 140 | mA |

* Unless otherwise noted all measurements performed as downconverter with high side LO & IF = 150 MHz.



BICMOS MIXER W/ INTEGRATED LO AMPLIFIER, 700 - 1100MHz

Upconverter Electrical Specifications,

$T_A = +25^\circ\text{C}$, LO = 0 dBm, Vcc = Vcc1, 2, 3 = +5V, G_Bias = +2.5V *

| Parameter | Min. | Typ. | Max. | Min. | Typ. | Max. | Units |
|--------------------------------|-------------|------|------|---------------|------|------|-------|
| Frequency Range, RF | 0.7 - 1.1 | | | 0.860 - 0.960 | | | GHz |
| Frequency Range, LO | 0.75 - 1.35 | | | 0.980 - 1.080 | | | GHz |
| Frequency Range, IF | 50 - 250 | | | 120 | | | MHz |
| Conversion Loss | | 7.5 | 9.5 | | 7.5 | 9.5 | dB |
| IP3 (Input) | | 33 | | | 36 | | dBm |
| 1 dB Compression (Input) | | 24 | | | 24 | | dBm |
| LO Drive Input Level (Typical) | -1 to +6 | | | -1 to +6 | | | dBm |
| Supply Current (Icc total) | 120 | 130 | 140 | 120 | 130 | 140 | mA |

*Unless otherwise noted all measurements performed as upconverter with high side LO & IF = 120 MHz.

Downconverter Performance

Conversion Gain vs. Temperature

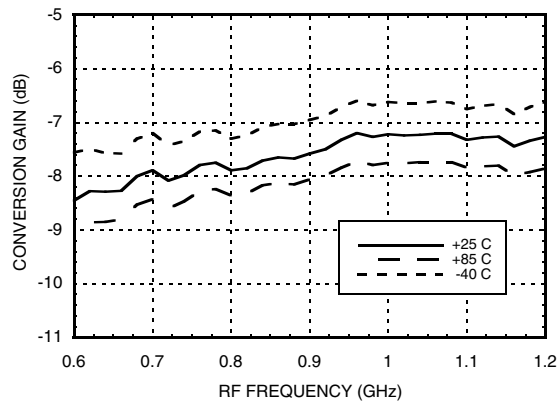

Conversion Gain vs. LO Drive

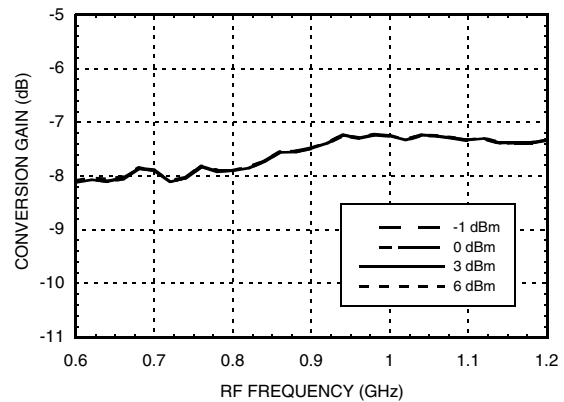

Conversion Gain vs. G_Bias voltage

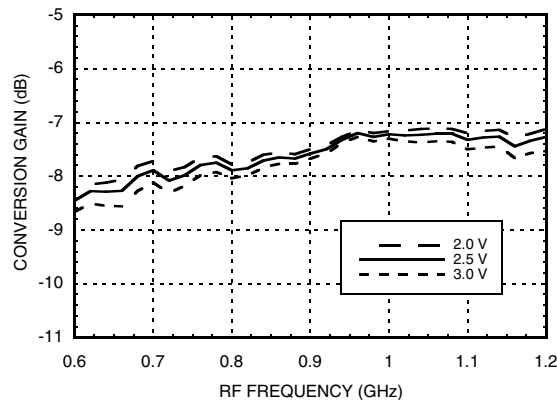

Information furnished by Analog Devices is believed to be accurate and reliable. However, no responsibility is assumed by Analog Devices for its use, nor for any infringements of patents or other rights of third parties that may result from its use. Specifications subject to change without notice. No license is granted by implication or otherwise under any patent or patent rights of Analog Devices. Trademarks and registered trademarks are the property of their respective owners.

For price, delivery, and to place orders: Analog Devices, Inc., One Technology Way, P.O. Box 9106, Norwood, MA 02062-9106 Phone: 781-329-4700 • Order online at www.analog.com Application Support: Phone: 1-800-ANALOG-D



BICMOS MIXER W/ INTEGRATED LO AMPLIFIER, 700 - 1100MHz

Downconverter Performance

Conversion Gain vs. IF Frequency

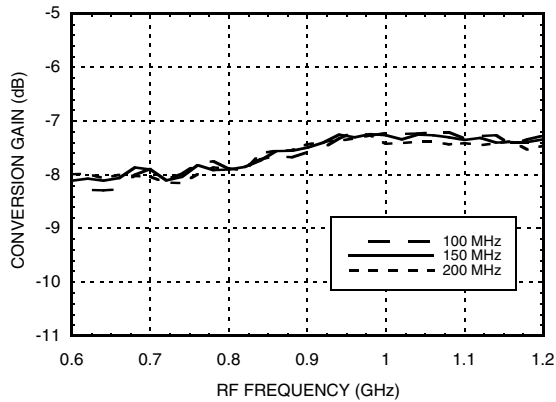

IF Bandwidth (LO = 1.1 GHz)

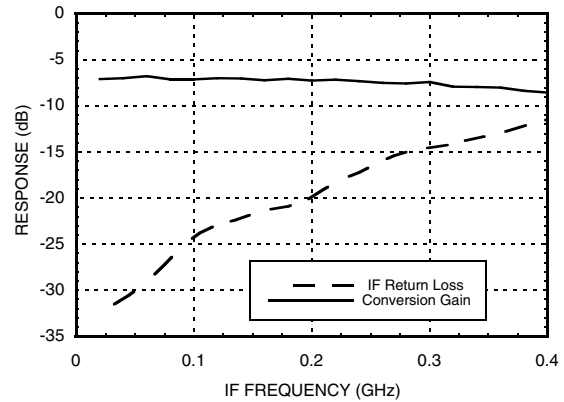

Input IP3 vs. Temperature [1]

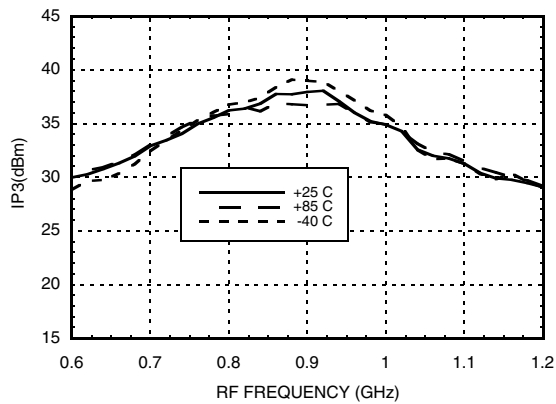

Input IP3 vs. LO Drive [1]

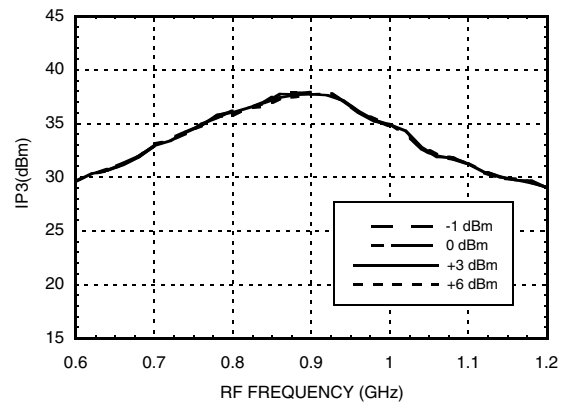

Input IP3 vs. G_Bias Voltage [1]

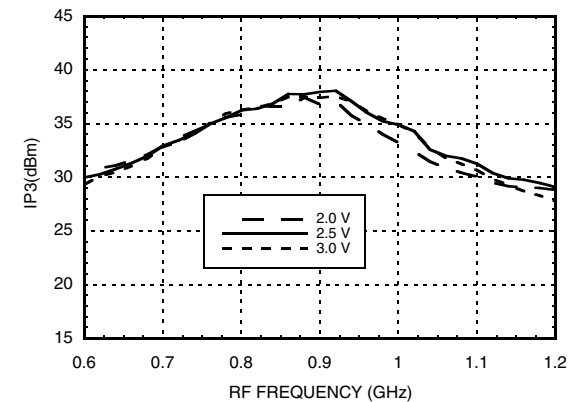

Input IP3 vs. IF Frequency [1]

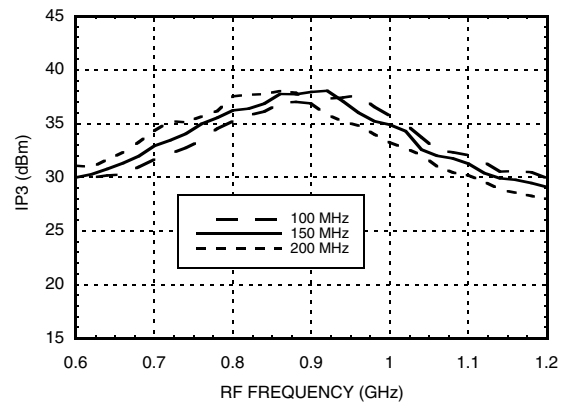

Information furnished by Analog Devices is believed to be accurate and reliable. However, no responsibility is assumed by Analog Devices for its use, nor for any infringements of patents or other rights of third parties that may result from its use. Specifications subject to change without notice. No license is granted by implication or otherwise under any patent or patent rights of Analog Devices. Trademarks and registered trademarks are the property of their respective owners.

For price, delivery, and to place orders: Analog Devices, Inc., One Technology Way, P.O. Box 9106, Norwood, MA 02062-9106 Phone: 781-329-4700 • Order online at www.analog.com Application Support: Phone: 1-800-ANALOG-D

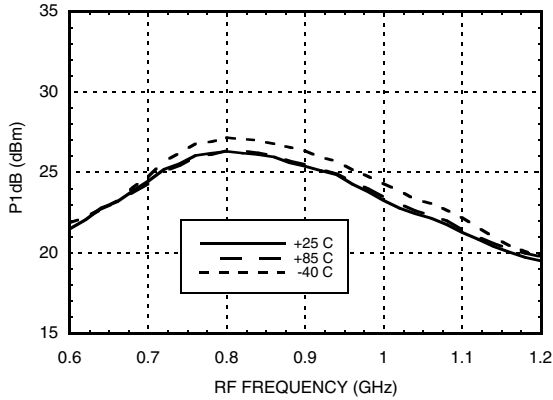
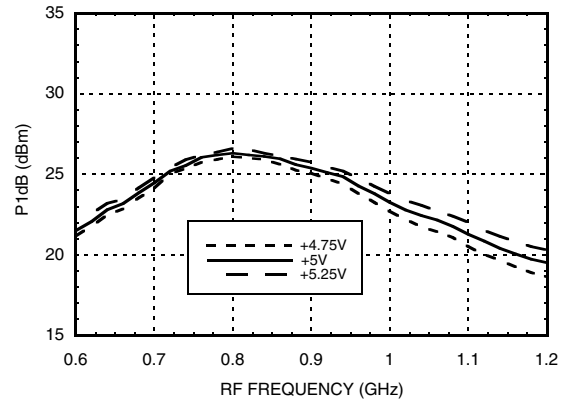
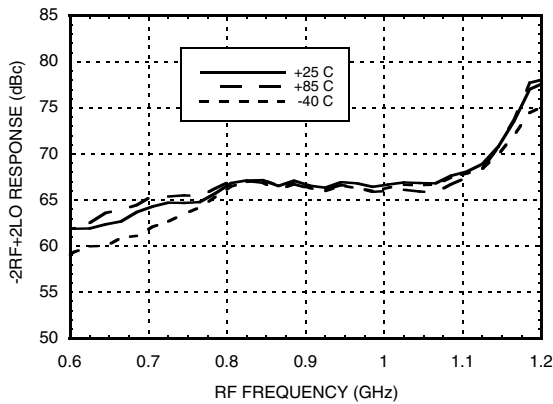
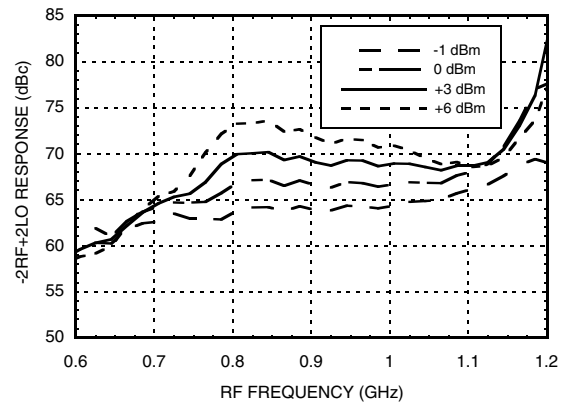
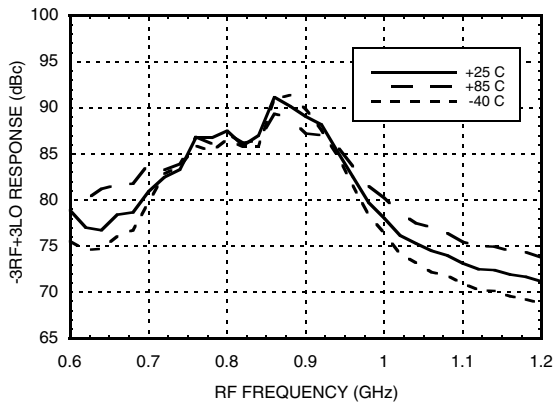
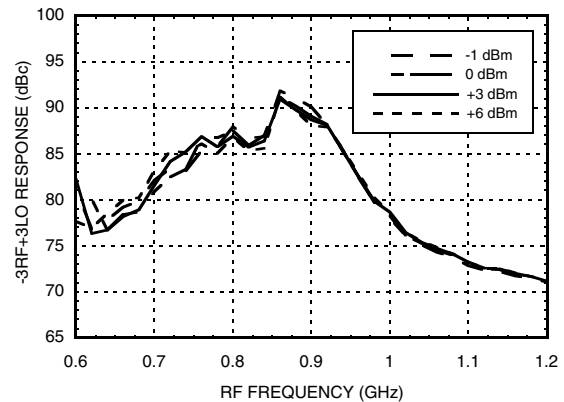

**BICMOS MIXER W/ INTEGRATED
LO AMPLIFIER, 700 - 1100MHz**
Downconverter Performance
Input P1dB vs. Temperature

Input P1dB vs. Vcc

-2RF +2LO Response vs. Temperature [2]

-2RF +2LO Response vs. LO Drive [2]

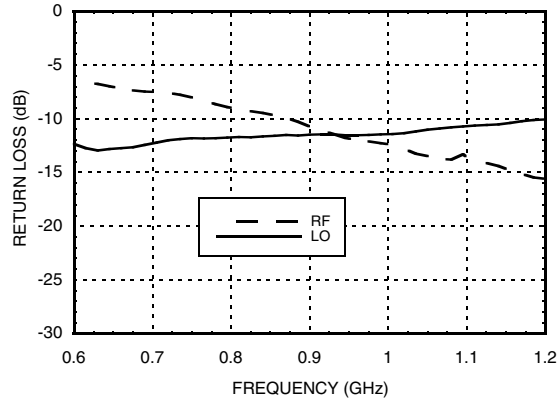
-3RF +3LO Response vs. Temperature [2]

-3RF +3LO Response vs. LO Drive [2]

[1] Two-tone input power = +9 dBm each tone, 1 MHz spacing. [2] Referenced to RF Input Power at 0 dBm



**BICMOS MIXER W/ INTEGRATED
LO AMPLIFIER, 700 - 1100MHz**

Return Loss



Isolation

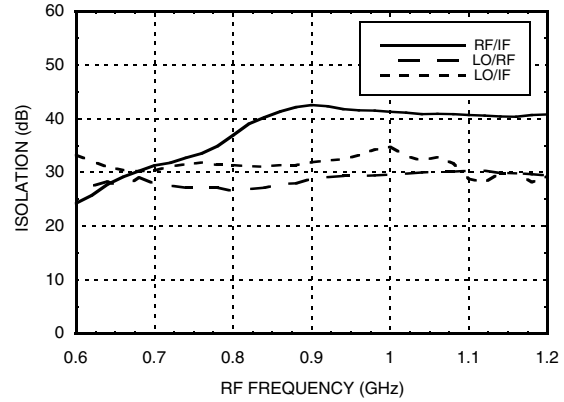

Upconverter Performance

Conversion Gain vs. Temperature

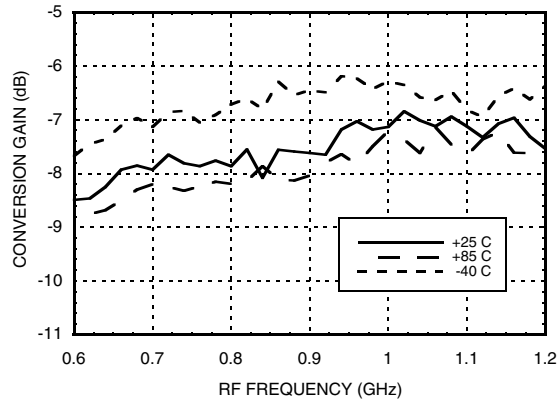

Conversion Gain vs. LO Drive

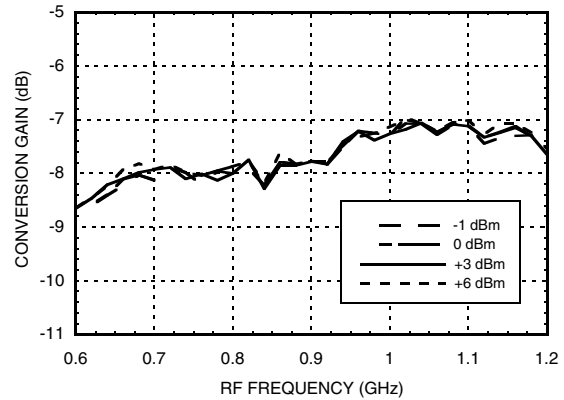

Conversion Gain vs. IF Frequency

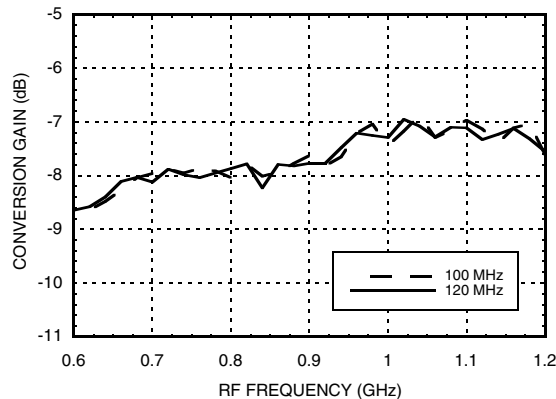

Information furnished by Analog Devices is believed to be accurate and reliable. However, no responsibility is assumed by Analog Devices for its use, nor for any infringements of patents or other rights of third parties that may result from its use. Specifications subject to change without notice. No license is granted by implication or otherwise under any patent or patent rights of Analog Devices. Trademarks and registered trademarks are the property of their respective owners.

For price, delivery, and to place orders: Analog Devices, Inc., One Technology Way, P.O. Box 9106, Norwood, MA 02062-9106 Phone: 781-329-4700 • Order online at www.analog.com Application Support: Phone: 1-800-ANALOG-D



**BICMOS MIXER W/ INTEGRATED
LO AMPLIFIER, 700 - 1100MHz**

Upconverter Performance

Input IP3 vs. Temperature [1]

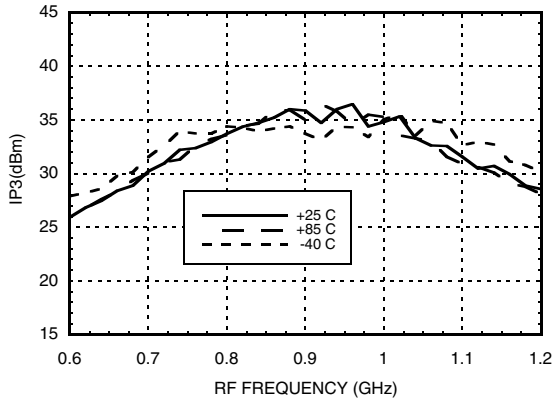

Input IP3 vs. LO Drive [1]

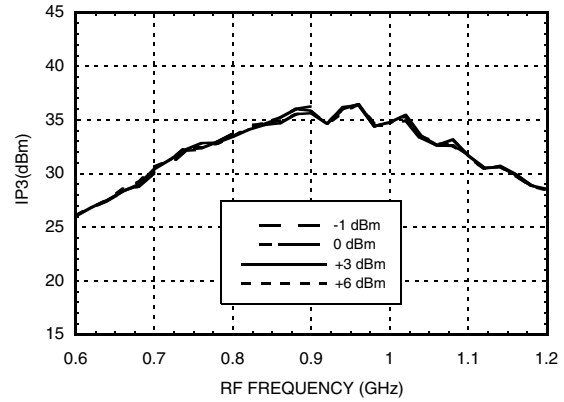

Input IP3 vs. IF Frequency [1]

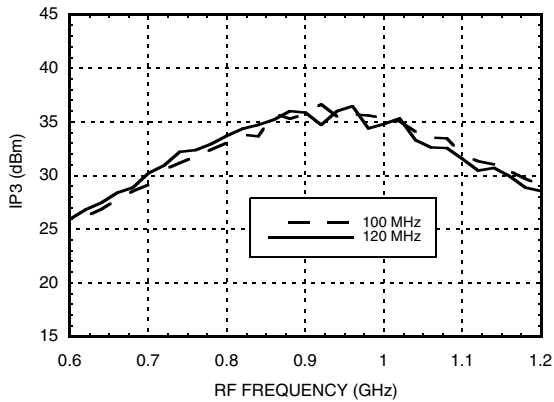

Input P1dB vs. Temperature

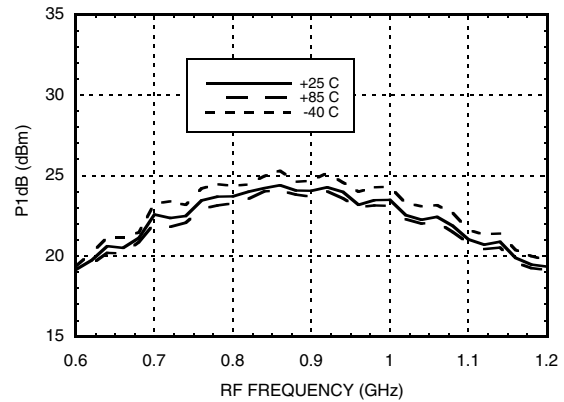

[1] Two-tone input power = +9 dBm each tone, 1 MHz spacing.

**BICMOS MIXER W/ INTEGRATED
LO AMPLIFIER, 700 - 1100MHz**
Absolute Maximum Ratings

| | |
|---|---------------|
| Vcc1, 2, 3 | 5.5 V |
| RF Input Power (Vcc1, 2, 3 = +5V) | +23 dBm |
| IF Input Power (Vcc1, 2, 3 = +5V) | +20 dBm |
| LO Drive (Vcc1, 2, 3 = +5V) | +10 dBm |
| Channel Temperature | 125 °C |
| Continuous Pdiss (T = 85°C) (derate 27 mW/°C above 85°C) | 1.0 W |
| Thermal Resistance (junction to ground paddle) | 37 °C/W |
| Storage Temperature | -65 to 150 °C |
| Operating Temperature | -40 to +85 °C |
| ESD Sensitivity (HBM) | Class 1A |

Typical Supply Current vs. Vcc

| Vcc1, 2, 3 (V) | Icc total (mA) |
|----------------|----------------|
| 4.75 | 120 |
| 5.00 | 130 |
| 5.25 | 145 |

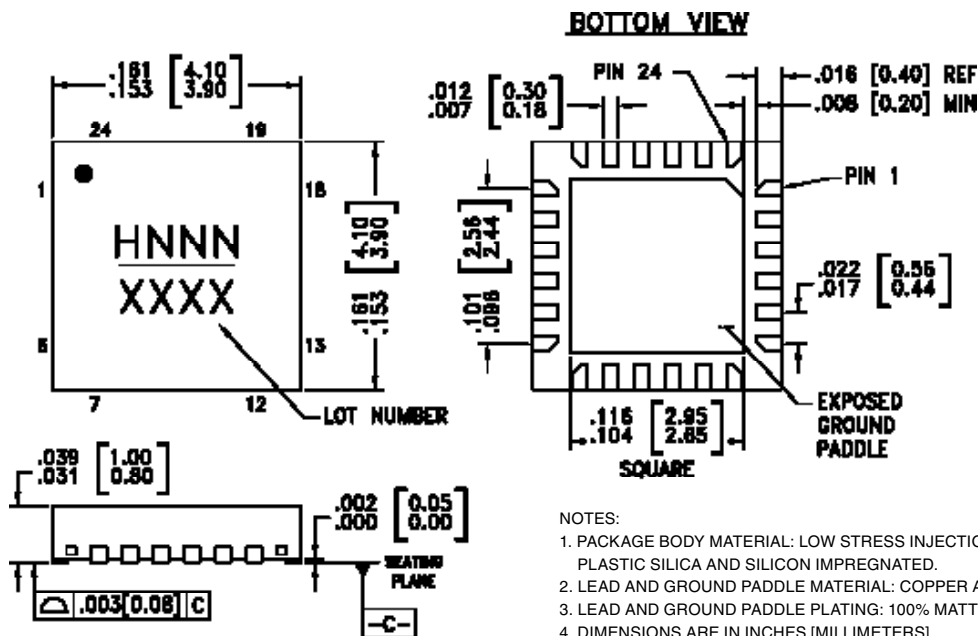
**ELECTROSTATIC SENSITIVE DEVICE
OBSERVE HANDLING PRECAUTIONS**
Outline Drawing

NOTES:

1. PACKAGE BODY MATERIAL: LOW STRESS INJECTION MOLDED PLASTIC SILICA AND SILICON IMPREGNATED.
2. LEAD AND GROUND PADDLE MATERIAL: COPPER ALLOY.
3. LEAD AND GROUND PADDLE PLATING: 100% MATTE TIN.
4. DIMENSIONS ARE IN INCHES [MILLIMETERS].
5. LEAD SPACING TOLERANCE IS NON-CUMULATIVE.
6. PAD BURR LENGTH SHALL BE 0.15mm MAX.
PAD BURR HEIGHT SHALL BE 0.25mm MAX.
7. PACKAGE WARP SHALL NOT EXCEED 0.05mm
8. ALL GROUND LEADS AND GROUND PADDLE MUST BE SOLDERED TO PCB RF GROUND.
9. REFER TO HITTITE APPLICATION NOTE FOR SUGGESTED PCB LAND PATTERN.

Package Information

| Part Number | Package Body Material | Lead Finish | MSL Rating | Package Marking [2] |
|-------------|--|---------------|------------|---------------------|
| HMC786LP4E | RoHS-compliant Low Stress Injection Molded Plastic | 100% matte Sn | MSL1 [1] | H786 XXXX |



[1] Max peak reflow temperature of 260 °C

[2] 4-Digit lot number XXXX

Information furnished by Analog Devices is believed to be accurate and reliable. However, no responsibility is assumed by Analog Devices for its use, nor for any infringements of patents or other rights of third parties that may result from its use. Specifications subject to change without notice. No license is granted by implication or otherwise under any patent or patent rights of Analog Devices. Trademarks and registered trademarks are the property of their respective owners.

For price, delivery, and to place orders: Analog Devices, Inc., One Technology Way, P.O. Box 9106, Norwood, MA 02062-9106
Phone: 781-329-4700 • Order online at www.analog.com
Application Support: Phone: 1-800-ANALOG-D

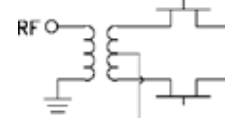

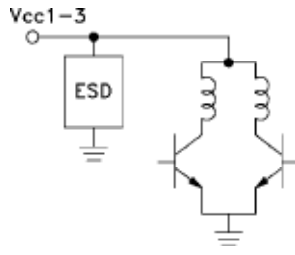
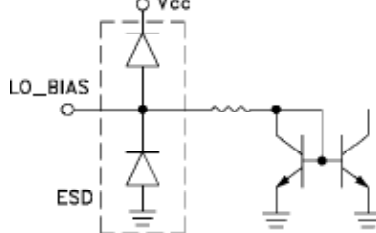
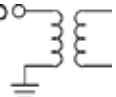
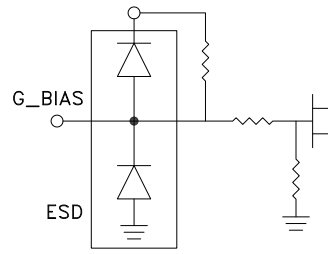
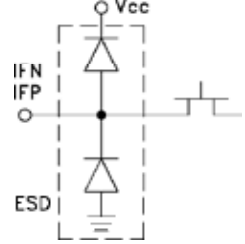
**BICMOS MIXER W/ INTEGRATED
LO AMPLIFIER, 700 - 1100MHz**
Pin Descriptions

| Pin Number | Function | Description | Interface Schematic |
|------------------------------|------------------|---|---|
| 1, 6, 7, 11 - 14, 18, 20, 23 | N/C | No connection. These pins may be connected to RF ground. Performance will not be affected. | |
| 2, 5, 15, 17 | GND | These pins and package bottom must be connected to RF/DC ground. |  |
| 3 | RF | This pin is matched single-ended to 50 Ohm and DC shorted to ground through a balun. |  |
| 4 | TAP | Center tap of secondary side of the internal RF balun. Short to ground with a zero Ohms close to the package. |  |
| 8, 10, 24 | Vcc1, Vcc2, Vcc3 | Power supply voltage. See application circuit for required external components. |  |
| 9 | LO_BIAS | LO buffer current adjustment pin. Adjust the LO buffer current through the external resistor R9 shown in the application circuit (connect 215 Ohms for nominal operation). This adjustment allows for a trade-off between power dissipation and linearity performance of the converter. |  |
| 16 | LO | This pin is matched single-ended to 50 Ohm and DC shorted to ground through a balun. |  |
| 19 | G_BIAS | External bias with a nominal value of 2.5V. See application circuit for recommended external components. G_Bias can be set to between 0 and 5Vdc. This adjustment allows for a trade off between conversion loss and linearity performance of the converter (see figures CG, IP3 vs. G_BIAS). The G_bias pin has an internal 15 KOhms resistance to ground and 15 KOhms to Vcc. Internal resistive divider sets 2.5 V for G_bias and can be changed externally. |  |
| 21, 22 | IFN, IFP | Differential IF input / output pins matched to differential 50 Ohms. For applications not requiring operation to DC an off chip DC blocking capacitor should be used. |  |

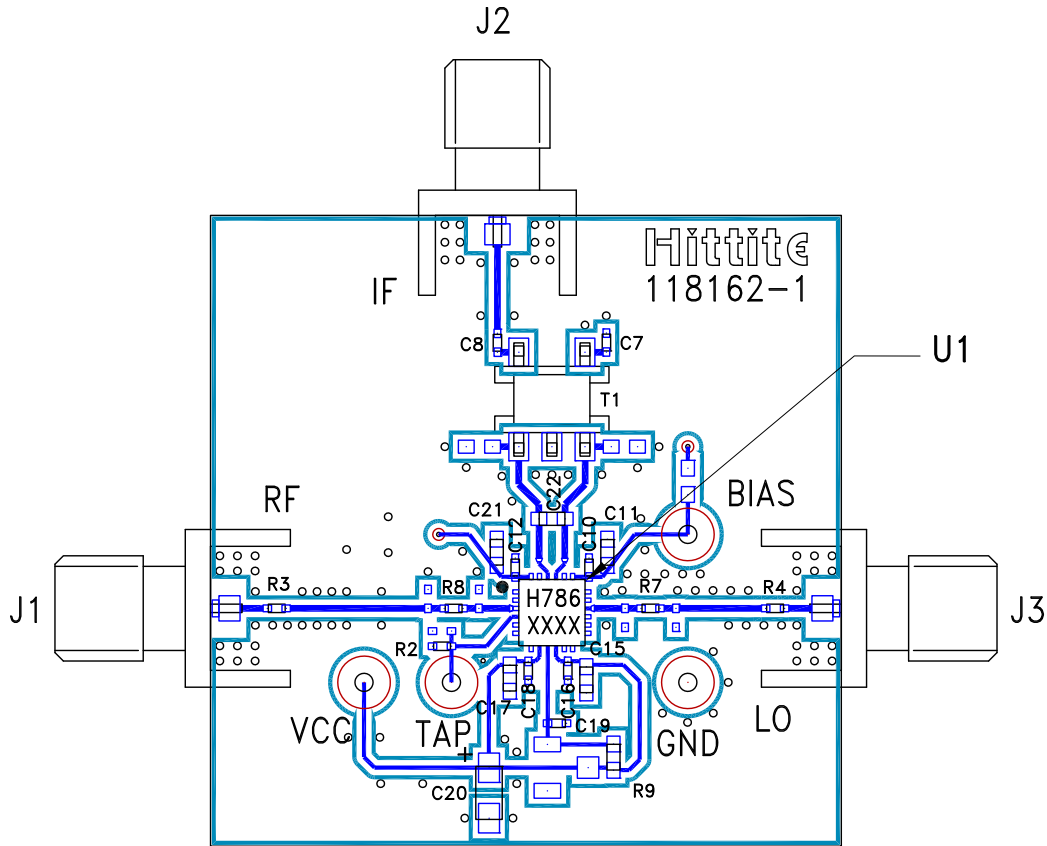

BICMOS MIXER W/ INTEGRATED LO AMPLIFIER, 700 - 1100MHz

Evaluation PCB



List of Materials for Evaluation PCB 121769 [1]

| Item | Description |
|--------------------|------------------------------------|
| J1 - J3 | SMA Connector |
| J4 - J7 | DC Pin |
| C7, C8 | 10 nF Capacitor, 0402 Pkg. |
| C10, C12, C16, C18 | 1 nF Capacitor, 0402 Pkg. |
| C11, C15, C17, C21 | 0.1 μF Capacitor, 0402 Pkg. |
| C19 | 22 pF Capacitor, 0402 Pkg. |
| C20 | 4.7 μF Case A, Tantalum |
| C22 | 1.8 pF Capacitor, 0603 Pkg. |
| R2 - R4, R7, R8 | 0 Ohm Resistor, 0402 Pkg. |
| R9 | 270 Ohm Resistor, 0603 Pkg. |
| T1 | 1:1 Transformer - Tyco MABA CT0039 |
| U1 | HMC786LP4E |
| PCB [2] | 118162 Evaluation PCB |

The circuit board used in the final application should use RF circuit design techniques. Signal lines should have 50 Ohm impedance while the package ground leads and exposed paddle should be connected directly to the ground plane similar to that shown. A sufficient number of via holes should be used to connect the top and bottom ground planes. The evaluation circuit board shown is available from Hittite upon request.

[1] Reference this number when ordering complete evaluation PCB

[2] Circuit Board Material: Rogers 4350 or Arlon 25 FR



BICMOS MIXER W/ INTEGRATED LO AMPLIFIER, 700 - 1100MHz

Application Circuit

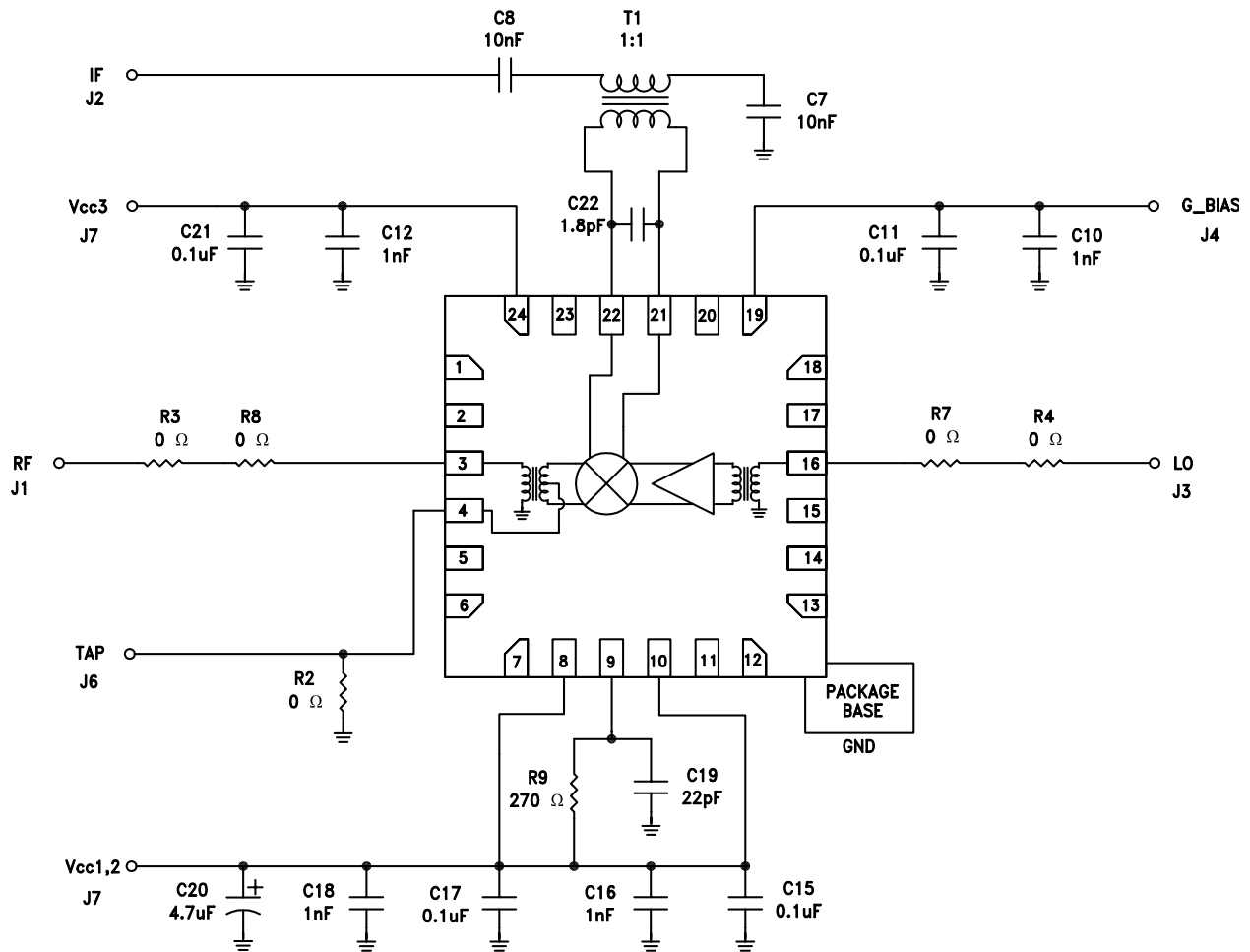

Information furnished by Analog Devices is believed to be accurate and reliable. However, no responsibility is assumed by Analog Devices for its use, nor for any infringements of patents or other rights of third parties that may result from its use. Specifications subject to change without notice. No license is granted by implication or otherwise under any patent or patent rights of Analog Devices. Trademarks and registered trademarks are the property of their respective owners.

For price, delivery, and to place orders: Analog Devices, Inc., One Technology Way, P.O. Box 9106, Norwood, MA 02062-9106 Phone: 781-329-4700 • Order online at www.analog.com Application Support: Phone: 1-800-ANALOG-D