

9.65 GHz to 10.41 GHz MMIC VCO with Half Frequency Output

FEATURES

- ▶ Dual output frequency range
 - ▶ $f_{OUT} = 9.65 \text{ GHz to } 10.41 \text{ GHz}$
 - ▶ $f_{OUT}/2 = 4.825 \text{ GHz to } 5.205 \text{ GHz}$
- ▶ Output power (P_{OUT}): 11 dBm
- ▶ Single-sideband (SSB) phase noise: -114 dBc/Hz at 100 kHz
- ▶ No external resonator needed
- ▶ RoHS compliant, 5 mm × 5 mm, 32-lead LFCSP: 25 mm²

APPLICATIONS

- ▶ Point to point and multipoint radios
- ▶ Test equipment and industrial controls
- ▶ Very small aperture terminals (VSATs)

GENERAL DESCRIPTION

The HMC1163 is a monolithic microwave integrated circuit (MMIC), voltage controlled oscillator (VCO) that integrates a resonator, a negative resistance device, and a varactor diode, and features a half frequency output.

Because of the monolithic construction of the oscillator, the output power and phase noise performance are excellent over temperature.

The output power is 11 dBm typical from a 5 V supply voltage. The VCO is housed in a RoHS compliant LFCSP and requires no external matching components.

FUNCTIONAL BLOCK DIAGRAM

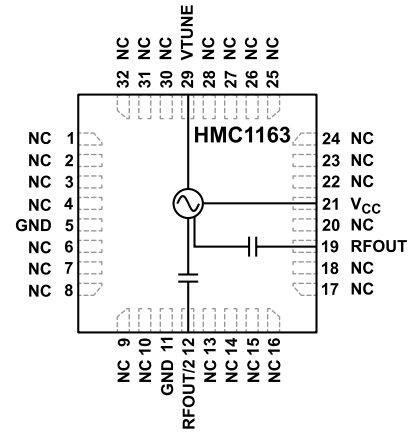

Figure 1.

001

TABLE OF CONTENTS

Features.....	1	Theory of Operation.....	9
Applications.....	1	Applications Information.....	10
Functional Block Diagram.....	1	Evaluation Printed Circuit Board (PCB).....	11
General Description.....	1	Bill of Materials.....	11
Specifications.....	3	Packaging and Ordering Information.....	12
Absolute Maximum Ratings.....	4	Outline Dimensions.....	12
ESD Caution.....	4	Ordering Guide.....	12
Pin Configuration and Function Descriptions.....	5	MSL Rating Options.....	12
Interface Schematics.....	6	Evaluation Boards.....	12
Typical Performance Characteristics.....	7		

REVISION HISTORY**8/2024—Rev. 0 to Rev. A**

Change to Half Output Frequency ($f_{OUT/2}$) Parameter, Table 1.....	3
Added MSL Rating Options.....	12

3/2016—Revision 0: Initial Version

SPECIFICATIONS

$T_A = -40^\circ\text{C}$ to $+85^\circ\text{C}$, $V_{CC} = 5\text{ V}$, unless otherwise noted.

Table 1.

Parameter	Min	Typ	Max	Unit	Test Conditions/Comments
FREQUENCY					
Range					
Output Frequency (f_{OUT})	9.65		10.41	GHz	
Half Output Frequency ($f_{OUT}/2$)	4.825		5.205	GHz	
Drift Rate		1.0		MHz/ $^\circ\text{C}$	
Pulling		2		MHz p-p	Pulling into a 2.0:1 voltage standing wave ratio (VSWR)
Pushing		7		MHz/V	At VTUNE = 5 V
OUTPUT POWER (P_{OUT})					
RFOUT	7	11	15	dBm	
RFOUT/2	2	6	11	dBm	
Supply Current (I_{CC})		185		mA	$V_{CC} = 4.75\text{ V}$
		205	250	mA	$V_{CC} = 5.00\text{ V}$
		230		mA	$V_{CC} = 5.25\text{ V}$
HARMONICS, SUBHARMONICS					
1/2		40		dBc	
3/2		29		dBc	
Second		19		dBc	
Third		23		dBc	
TUNING					
Voltage (VTUNE)	2		13	V	
Sensitivity	75		300	MHz/V	
Tune Port Leakage Current			10	μA	VTUNE = 13 V
OUTPUT RETURN LOSS					
		6		dB	
SSB PHASE NOISE					
10 kHz Offset		-87	-85	dBc/Hz	
100 kHz Offset		-114	-112	dBc/Hz	

ABSOLUTE MAXIMUM RATINGS

Table 2.

Parameter	Rating
V _{CC}	5.5 V dc
VTUNE	0 V to 15 V
Operating Temperature Range	-40°C to +85°C
Storage Temperature Range	-65°C to +150°C
Nominal Junction Temperature (to Maintain 1 Million Hours Mean Time to Failure (MTTF))	135°C
Nominal Junction Temperature (T _A = 85°C)	116.3°C
Maximum Reflow Temperature (MSL3 Rating)	260°C
Thermal Resistance (Junction to Ground Pad)	24.7°C/W
ESD Sensitivity	
Human Body Model (HBM)	300 V (Class 1A)
Field Induced Charged Device Model (FICDM)	300 V (Class II)

Stresses at or above those listed under Absolute Maximum Ratings may cause permanent damage to the product. This is a stress rating only; functional operation of the product at these or any other conditions above those indicated in the operational section of this specification is not implied. Operation beyond the maximum operating conditions for extended periods may affect product reliability.

ESD CAUTION



ESD (electrostatic discharge) sensitive device. Charged devices and circuit boards can discharge without detection. Although this product features patented or proprietary protection circuitry, damage may occur on devices subjected to high energy ESD. Therefore, proper ESD precautions should be taken to avoid performance degradation or loss of functionality.

PIN CONFIGURATION AND FUNCTION DESCRIPTIONS

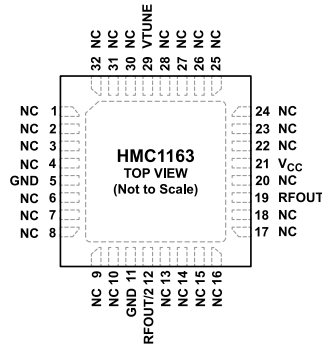

- NOTES
1. NC = NO CONNECT. HOWEVER, THESE PINS CAN BE CONNECTED TO RF/DC GROUND WITHOUT AFFECTING THE PERFORMANCE OF THE DEVICE.
 2. EXPOSED PAD. THE PACKAGE BOTTOM HAS AN EXPOSED METAL PAD THAT MUST BE CONNECTED TO RF/DC GROUND.

Figure 2. Pin Configuration

Table 3. Pin Function Descriptions

Pin No.	Mnemonic	Description
1 to 4, 6 to 10, 13 to 18, 20, 22 to 28, 30 to 32	NC	No Connect. However, these pins can be connected to RF/dc ground without affecting the performance of the device.
5, 11	GND	Ground. These pins must be connected to RF/dc ground.
12	RFOUT/2	Half Radio Frequency Output. This pin is ac-coupled.
19	RFOUT	Radio Frequency Output. This pin is ac-coupled.
21	V _{CC}	Supply Voltage (5 V).
29	VTUNE	Control Voltage and Modulation Input. The modulation bandwidth is dependent on the drive source impedance.
	EP	Exposed Pad. The package bottom has an exposed metal pad that must be connected to RF/dc ground.

PIN CONFIGURATION AND FUNCTION DESCRIPTIONS

INTERFACE SCHEMATICS

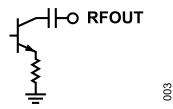

Figure 3. RFOUT Interface

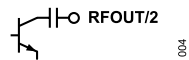

Figure 4. RFOUT/2 Interface

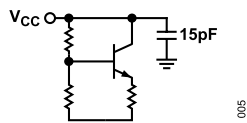

Figure 5. V_{CC} Interface

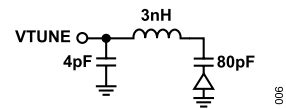

Figure 6. VTUNE Interface



Figure 7. GND Interface

TYPICAL PERFORMANCE CHARACTERISTICS

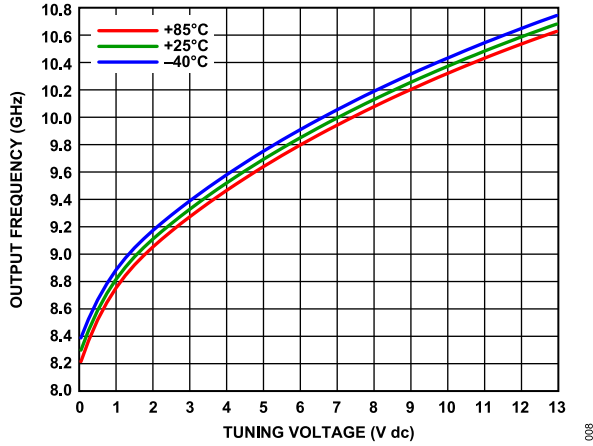

Figure 8. Output Frequency vs. Tuning Voltage

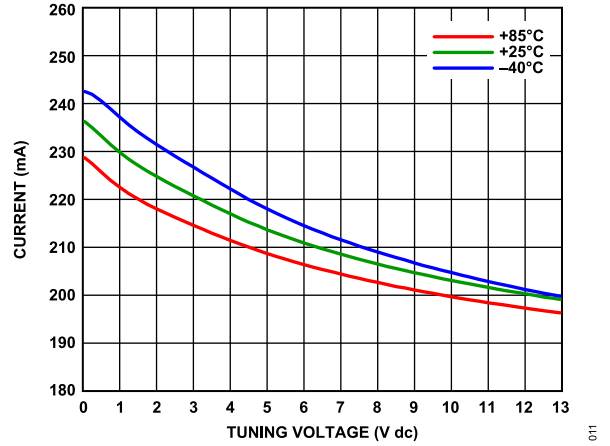

Figure 11. Supply Current (I_{CC}) vs. Tuning Voltage

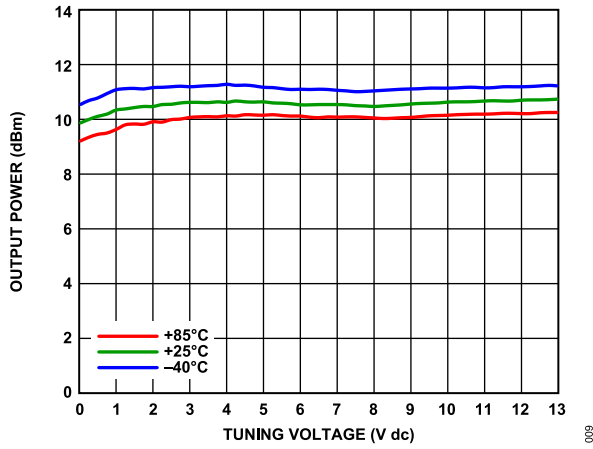

Figure 9. Output Power vs. Tuning Voltage

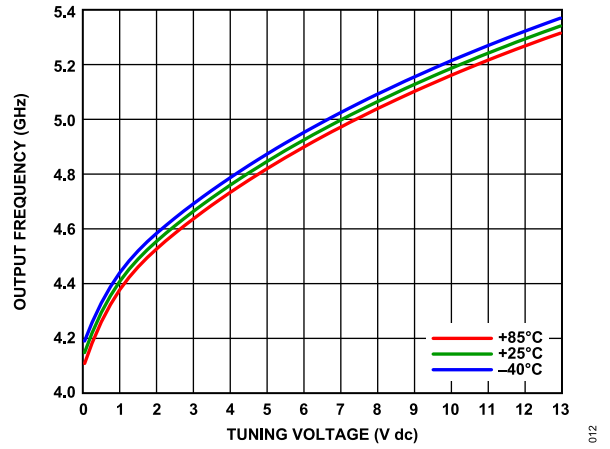

Figure 12. RFOUT/2 Output Frequency vs. Tuning Voltage

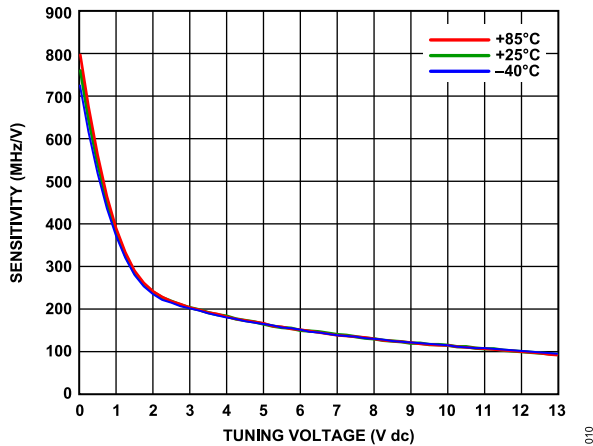

Figure 10. Sensitivity vs. Tuning Voltage

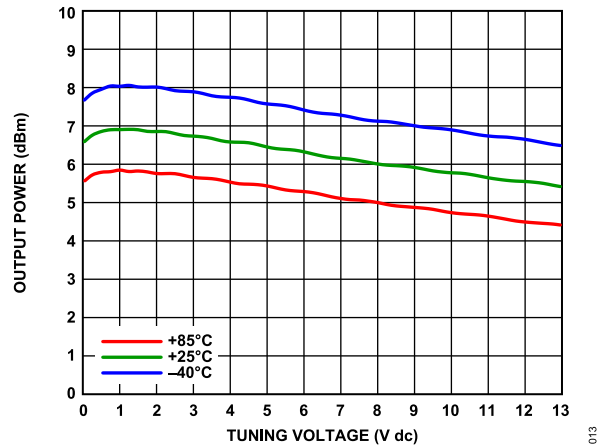

Figure 13. RFOUT/2 Output Power vs. Tuning Voltage

TYPICAL PERFORMANCE CHARACTERISTICS

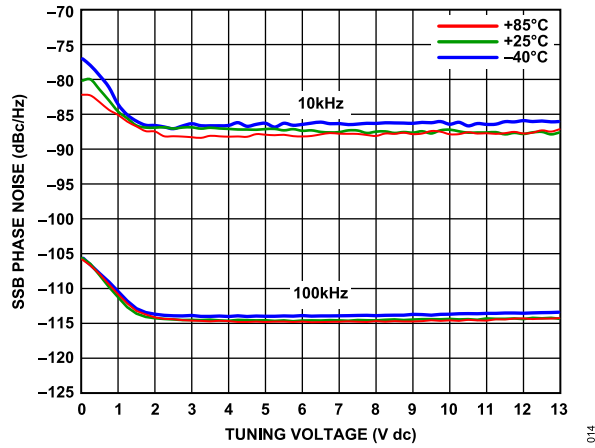

Figure 14. SSB Phase Noise vs. Tuning Voltage

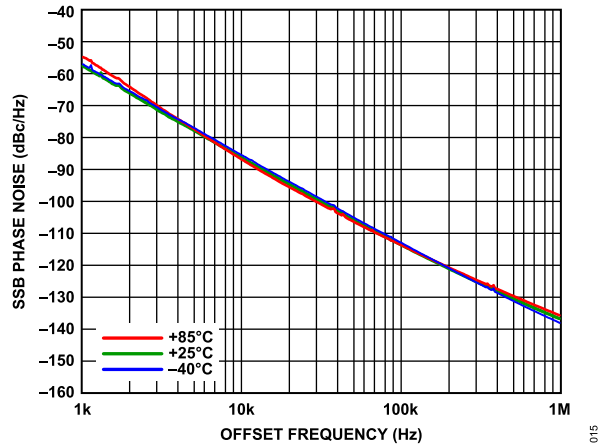

Figure 15. SSB Phase Noise vs. Offset Frequency at VTUNE = 5 V

THEORY OF OPERATION

The HMC1163 voltage controlled oscillator is a free running voltage controlled frequency source. The output frequency is controlled by applying a variable tune voltage to the VTUNE port. Because VTUNE is varied from the lowest to the highest allowed voltage, the VCO output frequency increases from the lowest to the highest operating frequency. This VCO output frequency change with the applied VTUNE input results in the VCO frequency sensitivity characteristic (MHz/V). The VCO frequency sensitivity is not constant and varies across the tunable range.

The HMC1163 VCO is specified to cover the minimum to maximum frequencies specified in this data sheet over the entire specified temperature range, including the VCO frequency drift (MHz/°C). In addition, for low phase noise operation, drive the VTUNE port from a low noise voltage source. Excessive noise on the VTUNE port results in poor phase noise performance. The tune port modulation bandwidth is typically greater than 10 MHz.

To achieve optimum VCO phase noise performance when using the HMC1163, it is important to use a low noise power supply for V_{CC}

biasing. Because the VCO output frequency changes with small changes in the V_{CC} bias voltage (pushing), noise on the V_{CC} bias pin results in increased phase noise. Take care to use low noise regulators, otherwise, bias line noise may corrupt the low phase noise output of the HMC1163.

Internally, the radio frequency (RF) output frequency is generated from a doubler circuit. This generation results in an unwanted low level output signal present at half the RFOUT frequency (RFOUT/2). If necessary, this undesired spurious signal can be further filtered on the customer application board using a filter. The RFOUT/2 output signal is available directly at the RFOUT/2 port. The RFOUT/2 port commonly drives a phase-locked loop (PLL)/ synthesizer for phase locking the HMC1163 output if needed.

Lastly, the HMC1163 RFOUT port incorporates an internal buffer amplifier to provide good output matching. The internal buffer amplifier also isolates the VCO core from the output load and minimizes the VCO frequency change with the changes to the output load impedance (pulling).

APPLICATIONS INFORMATION

The HMC1163 serves as the local oscillator (LO) in microwave synthesizer applications. The primary applications are point to point microwave radios, military, radars, test and measurement, as well as industrial and medical equipment. The low phase noise allows higher orders of modulation and offers improved bit error rates in communication systems, whereas the linear, monotonic tuning

sensitivity allows a stable loop filter design. The higher output power minimizes the gain required to drive subsequent stages. The half frequency output reduces the input frequency to the prescaler without the addition of residual phase noise to the input of the phase-locked loop synthesizer.

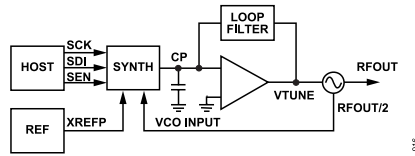

Figure 16. Typical Application Diagram

EVALUATION PRINTED CIRCUIT BOARD (PCB)

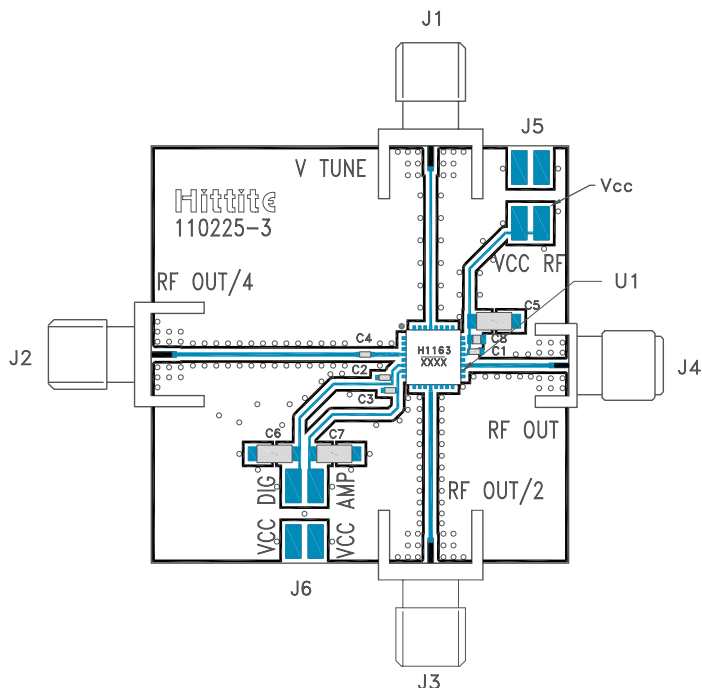

Figure 17. Evaluation PCB

The circuit board used in an application uses RF circuit design techniques. Ensure that the signal lines have 50 Ω impedance and that the package ground leads and backside ground paddle are connected directly to the ground plane.

Use a sufficient number of via holes to connect the top and bottom ground planes. The evaluation circuit board shown in Figure 17 is available from Analog Devices, Inc., upon request.

BILL OF MATERIALS

Table 4. Bill of Materials for the EVHMC1163LP5

Item	Description
J1 to J4	PCB mount SMA RF connectors
J5, J6	2 mm dc headers
C1 to C3	100 pF capacitors, 0402 package
C4	1000 pF capacitor, 0402 package
C5 to C7	2.2 μ F tantalum capacitors
C8	0.01 μ F capacitor, 0603 package
U1	HMC1163 VCO
PCB ¹	110225 evaluation board ²

¹ Circuit board material is Rogers 4350.

² Reference this number when ordering the complete evaluation PCB.

PACKAGING AND ORDERING INFORMATION

OUTLINE DIMENSIONS

Package Drawing (Option)	Package Type	Package Description
HCP-32-1	LFCSP	32-Lead Lead Frame Chip Scale Package

For the latest package outline information and land patterns (footprints), go to [Package Index](#).

ORDERING GUIDE

Model ¹	Temperature Range	Package Description	Packing Quantity	Package Option	Marking Code ²
HMC1163LP5E	-40°C to +85°C	32-Lead LFCSP	Cut Tape, 500	HCP-32-1	<u>H1163</u> XXXX
HMC1163LP5ETR	-40°C to +85°C	32-Lead LFCSP, 7" Tape and Reel	Reel, 500	HCP-32-1	<u>H1163</u> XXXX

¹ The HMC1163LP5E and HMC1163LP5ETR are RoHS compliant parts.

² XXXX is a placeholder for the 4-digit lot number.

MSL RATING OPTIONS

Model	MSL Rating ¹
HMC1163LP5E	MSL3
HMC1163LP5ETR	MSL3

¹ See the [Absolute Maximum Ratings](#) section, [Table 2](#).

EVALUATION BOARDS

Model ¹	Description
EV1HMC1163LP5	Evaluation Board

¹ The EV1HMC1163LP5 is a RoHS compliant part.