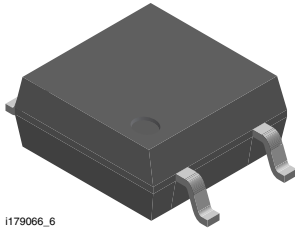
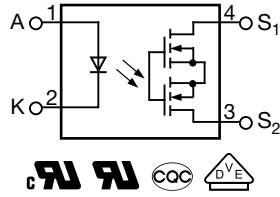


1 Form A Solid-State Relay



i179066_6



FEATURES

- Maximum R_{ON} 5 Ω
- Load voltage 60 V
- Load current 100 mA
- Isolation test voltage 3750 V_{RMS}
- Small 4 pin SOP package
- Clean bounce free switching
- TTL / CMOS compatible input
- High reliability hybrid receptor
- Available on tape and reel
- Material categorization: for definitions of compliance please see www.vishay.com/doc?99912



RoHS
COMPLIANT

LINKS TO ADDITIONAL RESOURCES



DESCRIPTION


The VO1400AEF is an optically isolated 1 form A solid-state relay in a surface mount 4 pin SOP package.

APPLICATIONS

- Security systems
- Instrumentation
- Industrial controls

AGENCY APPROVALS

- [UL 1577](#)
- [cUL](#)
- [DIN EN 60747-5-5 \(VDE 0884-5\)](#)
- [CQC](#)
- [FIMKO](#)

ORDERING INFORMATION											
V	O	1	4	0	0	A	E	F	T	#	 SOP
PART NUMBER						ELECTRICAL VARIATION	PACKAGE CONFIG.	TAPE AND REEL			
PACKAGE							UL, cUL, CQC, VDE, FIMKO				
SOP-4, tape and reel							VO1400AEFTR				
SOP-4, tape and reel (product rotated in tape)							VO1400AEFT1				

ABSOLUTE MAXIMUM RATINGS ($T_{amb} = 25\text{ }^{\circ}\text{C}$, unless otherwise specified)				
PARAMETER	CONDITIONS	SYMBOL	VALUE	UNIT
INPUT				
LED continuous forward current		I_F	50	mA
LED reverse voltage		V_R	5	V
OUTPUT				
DC or peak AC load voltage		V_L	60	V
Load current AC peak		I_L	100	mA
Peak load current	$t = 10\text{ ms}$	I_{LPK}	350	mA
SSR				
Total power dissipation		P_{diss}	120	mW
Ambient temperature range		T_{amb}	-40 to +85	$^{\circ}\text{C}$
Storage temperature range		T_{stg}	-40 to +125	$^{\circ}\text{C}$
Soldering temperature	$t \leq 10\text{ s max.}$	T_{sld}	260	$^{\circ}\text{C}$

Notes

- Stresses in excess of the absolute maximum ratings can cause permanent damage to the device. Functional operation of the device is not implied at these or any other conditions in excess of those given in the operational sections of this document. Exposure to absolute maximum ratings for extended periods of the time can adversely affect reliability.

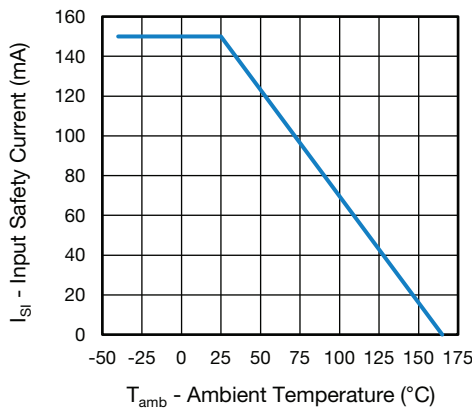
ABSOLUTE MAXIMUM RATING CURVE


Fig. 1 - Input Safety Current vs. Ambient Temperature

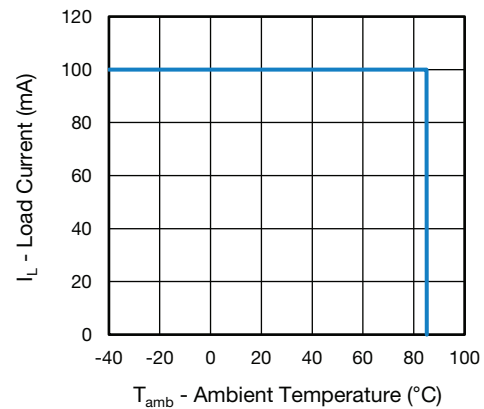


Fig. 3 - Load Current vs. Ambient Temperature

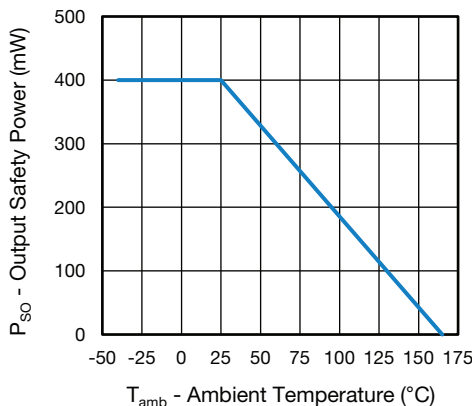


Fig. 2 - Output Safety Power vs. Ambient Temperature

ELECTRICAL CHARACTERISTICS ($T_{amb} = 25\text{ }^{\circ}\text{C}$, unless otherwise specified)						
PARAMETER	TEST CONDITION	SYMBOL	MIN.	TYP.	MAX.	UNIT
INPUT						
LED forward current, switch turn-on	$I_L = 100\text{ mA}$, $V_L \leq 0.5\text{ V}$, $t = 10\text{ ms}$	I_{Fon}	0.15	0.8	3.2	mA
LED forward current, switch turn-off	$V_L = 60\text{ V}$	I_{Foff}	100	400	-	μA
LED reverse current	$V_R = 5\text{ V}$	I_R	-	0.001	10	μA
LED forward voltage	$I_F = 5\text{ mA}$	V_F	0.8	1.4	1.6	V
LED reverse voltage	$I_R = 10\text{ }\mu\text{A}$	V_R	5	40		V
OUTPUT						
On-resistance	$I_F = 10\text{ mA}$, $I_L = 100\text{ mA}$	R_{ON}	-	2.3	5	Ω
Off-state leakage current	$I_F = 0\text{ mA}$, $V_L = 60\text{ V}$	I_{LEAK}	-	0.002	1	μA

Note

- Minimum and maximum values are testing requirements. Typical values are characteristics of the device and are the result of engineering evaluations. Typical values are for information only and are not part of the testing requirements.

SWITCHING CHARACTERISTICS						
PARAMETER	TEST CONDITION	SYMBOL	MIN.	TYP.	MAX.	UNIT
Turn-on time	$I_F = 10\text{ mA}$, $V_L = 20\text{ V}$, $I_L = 100\text{ mA}$	t_{on}	-	20	500	μs
Turn-off time	$I_F = 10\text{ mA}$, $V_L = 20\text{ V}$, $I_L = 100\text{ mA}$	t_{off}	-	80	500	μs

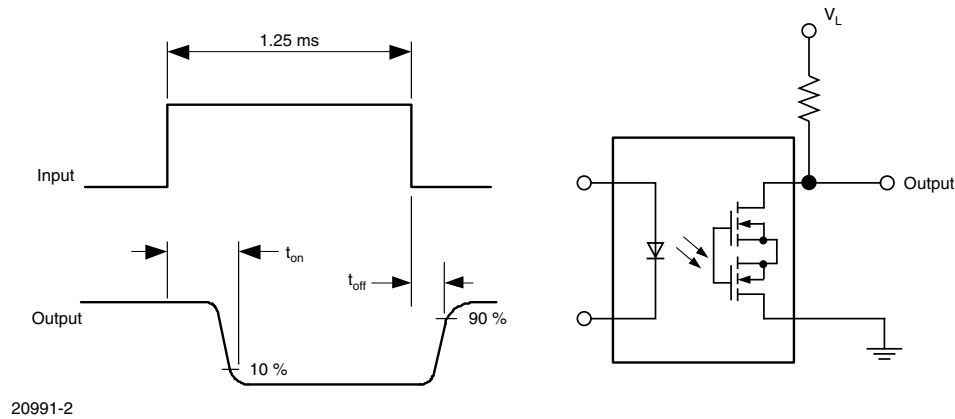


Fig. 4 - Timing Test Circuit and Waveforms



SAFETY AND INSULATION RATINGS				
PARAMETER	TEST CONDITION	SYMBOL	VALUE	UNIT
Climatic classification	According to IEC 68 part 1		40 / 85 / 21	
Pollution degree	According to DIN VDE 0109		2	
Comparative tracking index	Insulation group IIIa	CTI	175	
Maximum rated withstanding isolation voltage	According to UL1577, t = 1 min	V _{ISO}	3750	V _{RMS}
Maximum transient isolation voltage	According to DIN EN 60747-5-5	V _{IOTM}	6000	V _{peak}
Maximum repetitive peak isolation voltage	According to DIN EN 60747-5-5	V _{IORM}	707	V _{peak}
Insulation resistance	T _{amb} = 25 °C, V _{IO} = 500 V	R _{IO}	≥ 10 ¹²	Ω
	T _{amb} = 100 °C, V _{IO} = 500 V	R _{IO}	≥ 10 ¹¹	Ω
	T _{amb} = T _S , V _{IO} = 500 V	R _{IO}	≥ 10 ⁹	Ω
Output safety power		P _{SO}	400	mW
Input safety current		I _{SI}	150	mA
Input safety temperature		T _S	165	°C
Clearance distance	Measured from input terminals to output terminals, shortest distance through air		≥ 5	mm
Creepage distance	Measured from input terminals to output terminals, shortest distance path along body		≥ 5	mm
Input to output test voltage, method B	V _{IORM} × 1.875 = V _{PR} , 100 % production test with t _M = 1 s, partial discharge < 5 pC	V _{PR}	1326	V _{peak}
Input to output test voltage, method A	V _{IORM} × 1.6 = V _{PR} , 100 % sample test with t _M = 10 s, partial discharge < 5 pC	V _{PR}	1131	V _{peak}

Note

- This SSR is suitable for “safe electrical insulation” only within the safety ratings. Compliance with the safety ratings shall be ensured by means of protective circuits.



TYPICAL CHARACTERISTICS (T_{amb} = 25 °C, unless otherwise specified)

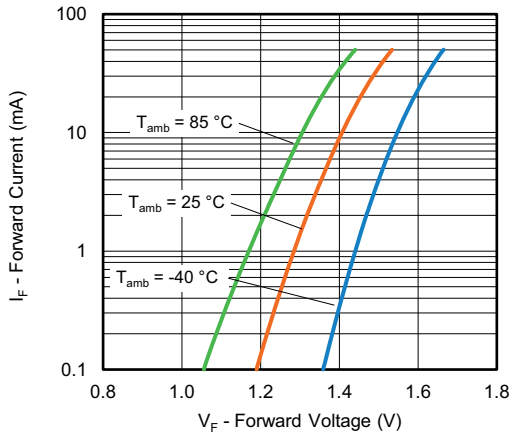


Fig. 5 - Forward Current vs. Forward Voltage

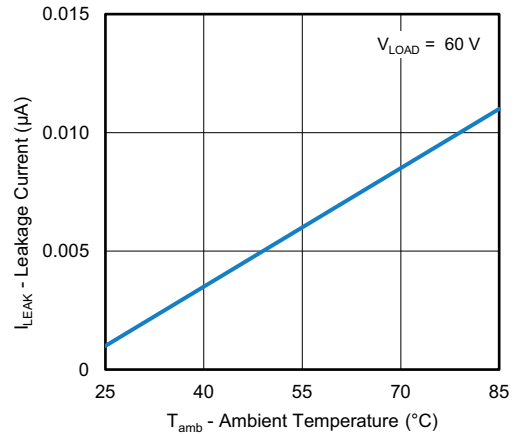


Fig. 8 - Leakage Current vs. Ambient Temperature

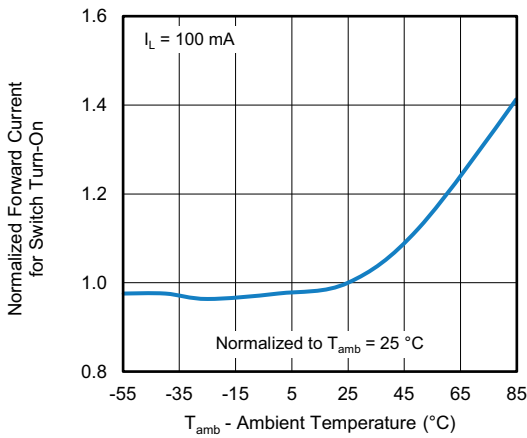


Fig. 6 - Forward Current for Switch Turn-On vs. Ambient Temperature

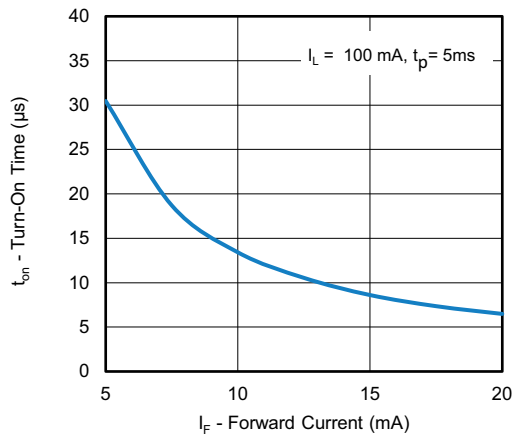


Fig. 9 - Turn-On Time vs. Forward Current

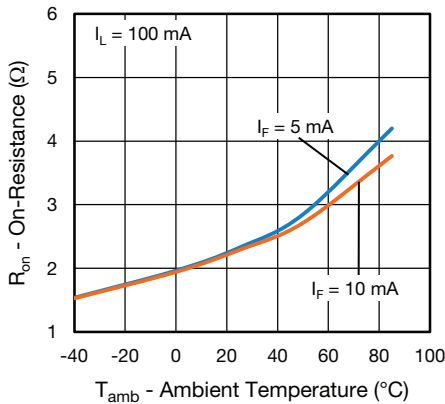


Fig. 7 - On-Resistance vs. Ambient Temperature

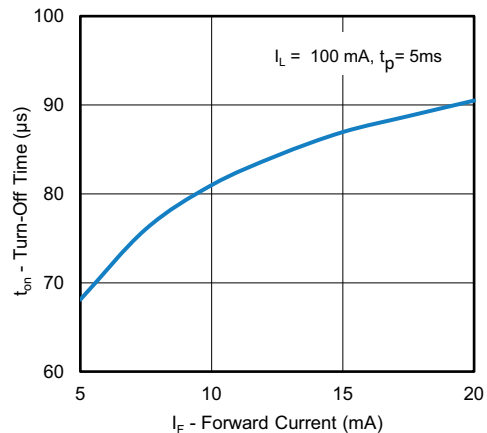


Fig. 10 - Turn-Off Time vs. Forward Current

PACKAGE DIMENSIONS (in millimeters)

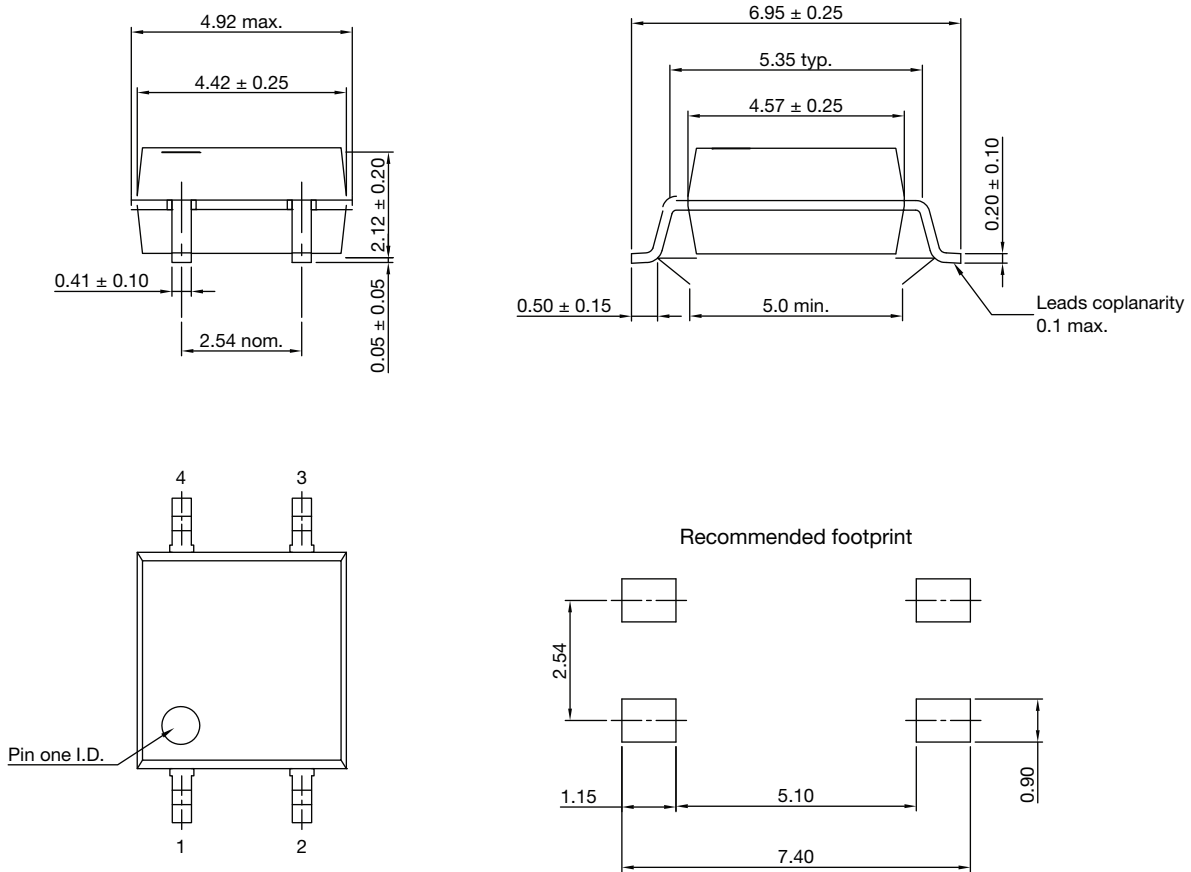


Fig. 11 - Package Drawings

PACKAGE MARKING

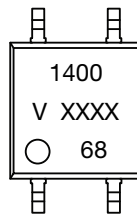
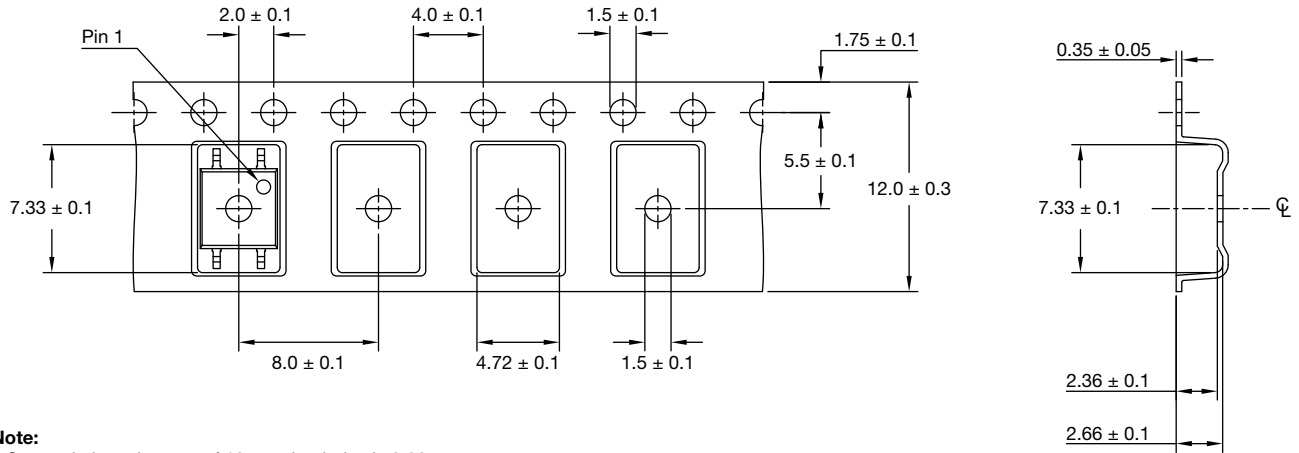


Fig. 12 - VO1400AEF

Notes

- XXXX = LMC (lot marking code)
- Tape and reel suffix (TR) is not part of the package marking

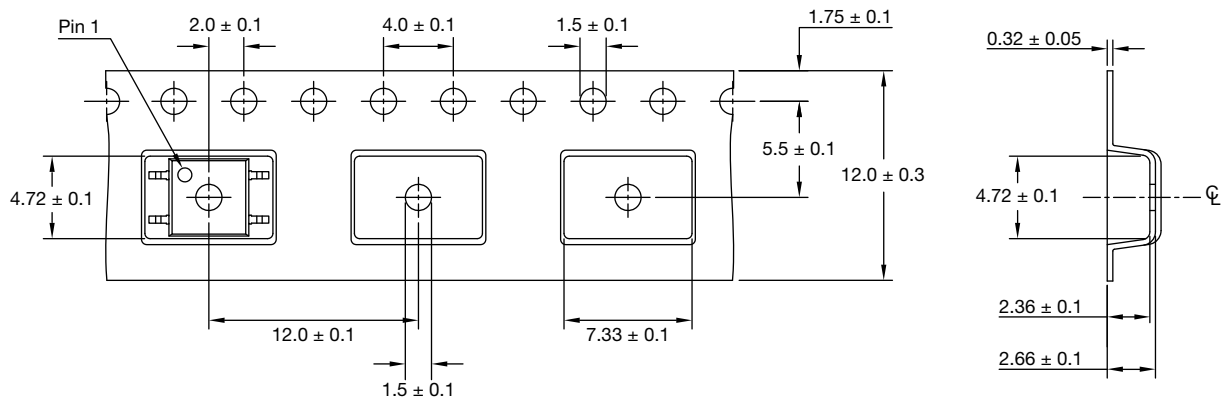
TAPE AND REEL INFORMATION (in millimeters)



Note:

- Cumulative tolerance of 10 spocket holes is 0.20

Fig. 13 - VO1400AEFT (2000 pieces on reel)

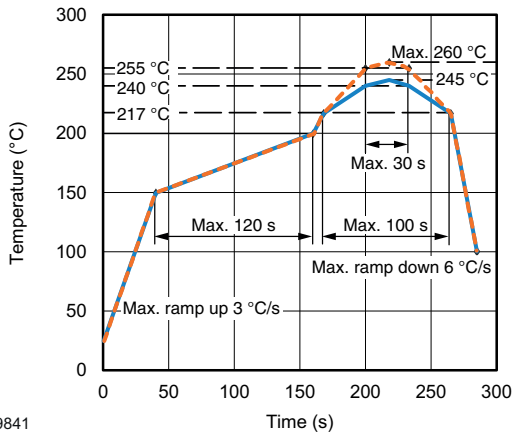


Note:

- Cumulative tolerance of 10 spocket holes is 0.20

Fig. 14 - VO1400AEFT1 (1000 pieces on reel)

SOLDER PROFILES



19841

Fig. 15 - Lead (Pb)-free Reflow Solder Profile According to J-STD-020 for SMD Devices

HANDLING AND STORAGE CONDITIONS

ESD level: HBM class 2

Floor life: unlimited

Conditions: $T_{amb} < 30\text{ °C}$, RH < 85 %

Moisture sensitivity level 1, according to J-STD-020



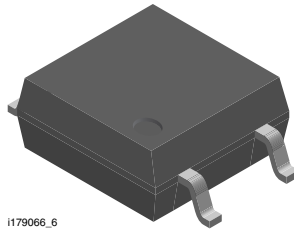
Footprint and Schematic Information for VO1400AEF

The footprint and schematic symbols for the following parts can be accessed using the associated links. They are available in Eagle, Altium, KiCad, OrCAD / Allegro, Pulsonix, and PADS.

Note that the 3D models for these parts can be found on the Vishay product page.

PART NUMBER	FOOTPRINT / SCHEMATIC
VO1400AEFT1	www.snapeda.com/parts/VO1400AEFT1/Vishay/view-part
VO1400AEFT2	www.snapeda.com/parts/VO1400AEFT2/Vishay/view-part
VO1400AEFTR	www.snapeda.com/parts/VO1400AEFTR/Vishay/view-part

For technical issues and product support, please contact optocoupleranswers@vishay.com.





Disclaimer

ALL PRODUCT, PRODUCT SPECIFICATIONS AND DATA ARE SUBJECT TO CHANGE WITHOUT NOTICE TO IMPROVE RELIABILITY, FUNCTION OR DESIGN OR OTHERWISE.

Vishay Intertechnology, Inc., its affiliates, agents, and employees, and all persons acting on its or their behalf (collectively, "Vishay"), disclaim any and all liability for any errors, inaccuracies or incompleteness contained in any datasheet or in any other disclosure relating to any product.

Vishay makes no warranty, representation or guarantee regarding the suitability of the products for any particular purpose or the continuing production of any product. To the maximum extent permitted by applicable law, Vishay disclaims (i) any and all liability arising out of the application or use of any product, (ii) any and all liability, including without limitation special, consequential or incidental damages, and (iii) any and all implied warranties, including warranties of fitness for particular purpose, non-infringement and merchantability.

Statements regarding the suitability of products for certain types of applications are based on Vishay's knowledge of typical requirements that are often placed on Vishay products in generic applications. Such statements are not binding statements about the suitability of products for a particular application. It is the customer's responsibility to validate that a particular product with the properties described in the product specification is suitable for use in a particular application. Parameters provided in datasheets and / or specifications may vary in different applications and performance may vary over time. All operating parameters, including typical parameters, must be validated for each customer application by the customer's technical experts. Product specifications do not expand or otherwise modify Vishay's terms and conditions of purchase, including but not limited to the warranty expressed therein.

Hyperlinks included in this datasheet may direct users to third-party websites. These links are provided as a convenience and for informational purposes only. Inclusion of these hyperlinks does not constitute an endorsement or an approval by Vishay of any of the products, services or opinions of the corporation, organization or individual associated with the third-party website. Vishay disclaims any and all liability and bears no responsibility for the accuracy, legality or content of the third-party website or for that of subsequent links.

Vishay products are not designed for use in life-saving or life-sustaining applications or any application in which the failure of the Vishay product could result in personal injury or death unless specifically qualified in writing by Vishay. Customers using or selling Vishay products not expressly indicated for use in such applications do so at their own risk. Please contact authorized Vishay personnel to obtain written terms and conditions regarding products designed for such applications.

No license, express or implied, by estoppel or otherwise, to any intellectual property rights is granted by this document or by any conduct of Vishay. Product names and markings noted herein may be trademarks of their respective owners.