

### ■ Features

- Metal housing design with functional Ground
- Class II design
- Constant Current mode output
- Built-in active PFC function
- No load / Standby power consumption <0.5W
- IP67 / IP65 rating for indoor or outdoor installations
- Function options: output adjustable via potentiometer;
- 3 in 1 dimming (dim-to-off); Smart timer dimming; DALI;
- Typical lifetime>50000 hours
- 5 years warranty

### ■ Applications

- LED street lighting
- LED harbor lighting
- LED bay lighting
- LED greenhouse lighting
- LED flood lighting
- Comply with class II application

### ■ GTIN CODE

MW Search: <https://www.meanwell.com/serviceGTIN.aspx>

### ■ Description

ELGT-150-C series is a 105~150W LED AC/DC classII driver featuring the constant current mode and high voltage output. ELGT-150-C operates from 100~305VAC and offers models with different rated current ranging between 700mA and 1400mA. Thanks to the high efficiency up to 92%, with the fanless design, the entire series is able to operate for -40°C~+90°C case temperature under free air convection. The design of metal housing and IP67/IP65 ingress protection level allows this series to fit both indoor and outdoor applications. ELGT-150-C is equipped with various function options, such as dimming methodologies, so as to provide the optimal design flexibility for LED lighting system.

### ■ Model Encoding

**ELGT-150 - C700 A**

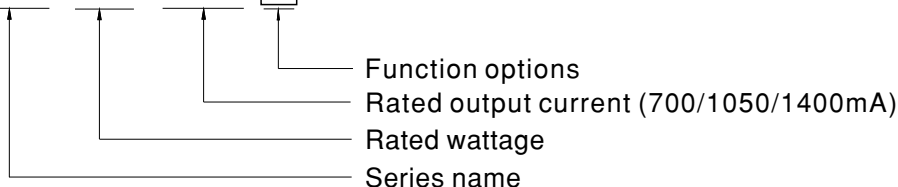

Type	IP Level	Function
Blank	IP67	Io fixed.
A	IP65	Io adjustable through built-in potentiometer.
B	IP67	3 in 1 dimming function (0~10Vdc, 10V PWM signal and resistance)
AB	IP65	Io adjustable through built-in potentiometer& 3 in 1 dimming function (0~10Vdc, 10V PWM signal and resistance)
DA	IP67	DALI control technology.
D2	IP67	Built-in Smart timer dimming and programmable function.

**SPECIFICATION**

MODEL		ELGT-150-C700 □	ELGT-150-C1050 □	ELGT-150-C1400 □
OUTPUT	RATED CURRENT	700mA	1050mA	1400mA
	RATED POWER	200VAC ~ 305VAC		
		149.8W	150.15W	149.8W
		100VAC ~ 180VAC		
		105W	105W	105W
	CONSTANT CURRENT REGION <small>Note.2</small>	107 ~ 214V	72 ~ 143V	54 ~ 107V
	OPEN CIRCUIT VOLTAGE <sub>(max.)</sub>	225V	151V	115V
	CURRENT ADJ. RANGE	Adjustable for A/AB-Type only (via built-in potentiometer)		
		350 ~ 700mA	525 ~ 1050mA	700 ~ 1400mA
CURRENT RIPPLE	5.0% max. @rated current			
CURRENT TOLERANCE	±5.0%			
SET UP TIME <small>Note.4</small>	1600ms/115VAC    500ms/230VAC			
INPUT	VOLTAGE RANGE <small>Note.3</small>	100 ~ 305VAC    142 ~ 431VDC (Please refer to "STATIC CHARACTERISTIC" section)		
	FREQUENCY RANGE	47 ~ 63Hz		
	POWER FACTOR (Typ.)	PF ≥ 0.97/115VAC, PF ≥ 0.95/230VAC, PF ≥ 0.92/277VAC@full load (Please refer to "POWER FACTOR (PF) CHARACTERISTIC" section)		
	TOTAL HARMONIC DISTORTION	THD < 20% (@load ≥ 50%/115VAC; @load ≥ 60%/230VAC; @load ≥ 75%/277VAC) (Please refer to "TOTAL HARMONIC DISTORTION (THD)" section)		
	EFFICIENCY (Typ.)	92%	92%	91%
	AC CURRENT (Typ.)	1.7A / 115VAC	0.9A / 230VAC	0.7A/277VAC
	INRUSH CURRENT(Typ.)	COLD START 65A(twidth=485µs measured at 50% Ipeak)/230VAC; Per NEMA 410		
	MAX. No. of PSUs on 16A CIRCUIT BREAKER	3 units (circuit breaker of type B) / 6 units (circuit breaker of type C) at 230VAC		
	LEAKAGE CURRENT	<0.7mA / 240VAC		
NO LOAD / STANDBY POWER CONSUMPTION	No load power consumption <0.5W for Blank / A / D2-Type Standby power consumption <0.5W for B / DA-Type			
PROTECTION	SHORT CIRCUIT	Hiccup mode, recovers automatically after fault condition is removed		
	OVER VOLTAGE	230 ~ 265V	155 ~ 180V	128 ~ 150V
		Shut down o/p voltage, re-power on to recover		
OVER TEMPERATURE	Shut down o/p voltage, re-power on to recover			
ENVIRONMENT	WORKING TEMP.	Tcase=-40 ~ +90°C (Please refer to " OUTPUT LOAD vs TEMPERATURE" section)		
	MAX. CASE TEMP.	Tcase=+90°C		
	WORKING HUMIDITY	20 ~ 95% RH non-condensing		
	STORAGE TEMP., HUMIDITY	-40 ~ +80°C, 10 ~ 95% RH		
	TEMP. COEFFICIENT	±0.03%/°C (0 ~ 60°C)		
VIBRATION	10 ~ 500Hz, 5G 12min./1cycle, period for 72min. each along X, Y, Z axes			
SAFETY & EMC	SAFETY STANDARDS	ENEC BS EN/EN61347-1(except for AB-Type), BS EN/EN61347-2-13(except for AB-Type) independent, BS EN/EN62384(except for AB-Type); EAC TP TC 004; IP65 or IP67 approved		
	DALI STANDARDS	Compliance to IEC62386-101, 102, 207 for DA-Type only		
	WITHSTAND VOLTAGE	I/P-O/P:3.75KVAC    I/P-CASE:3.75KVAC    O/P-CASE:1.5KVAC		
	ISOLATION RESISTANCE	I/P-O/P, I/P-FG, O/P-FG:100M Ohms / 500VDC / 25°C / 70% RH		
	EMC EMISSION	Compliance to BS EN/EN55015, BS EN/EN61000-3-2 Class C (@load ≥ 60%) ; BS EN/EN61000-3-3; EAC TP TC 020		
EMC IMMUNITY	Compliance to BS EN/EN61000-4-2,3,4,5,6,8,11; BS EN/EN61547, light industry level (surge immunity Line-Earth 6KV, Line-Line 4KV);EAC TP TC 020			
OTHERS	MTBF	3106.9K hrs min.    Telcordia SR-332 (Bellcore) ;294.8K hrs min.    MIL-HDBK-217F (25°C)		
	DIMENSION	219*63*35.5 mm (L*W*H)		
	PACKING	0.95Kg; 16pcs / 16.0kg / 0.77CUFT		
NOTE	1. All parameters NOT specially mentioned are measured at 230VAC input, rated current and 25°C of ambient temperature. 2. Please refer to "DRIVING METHODS OF LED MODULE". For DA-Type, Constant Current region is 60%~100% of maximum voltage under rated power delivery. 3. De-rating may be needed under low input voltages. Please refer to "STATIC CHARACTERISTIC" sections for details. 4. Length of set up time is measured at first cold start. Turning ON/OFF the driver may lead to increase of the set up time. 5. The driver is considered as a component that will be operated in combination with final equipment. Since EMC performance will be affected by the complete installation, the final equipment manufacturers must re-qualify EMC Directive on the complete installation again. (as available on <a href="https://www.meanwell.com/Upload/PDF/EMI_statement_en.pdf">https://www.meanwell.com/Upload/PDF/EMI_statement_en.pdf</a> ) 6. This series meets the typical life expectancy of >50,000 hours of operation when Tcase, particularly (Tc) point (or TMP, per DLC), is about 75°C or less. 7. Please refer to the warranty statement on MEAN WELL's website at <a href="http://www.meanwell.com">http://www.meanwell.com</a> 8. The ambient temperature derating of 3.5°C/1000m with fanless models and of 5°C/1000m with fan models for operating altitude higher than 2000m(6500ft). 9. For any application note and IP water proof function installation caution, please refer our user manual before using. <a href="https://www.meanwell.com/Upload/PDF/LED_EN.pdf">https://www.meanwell.com/Upload/PDF/LED_EN.pdf</a> 10. To fulfill requirements of the latest ErP regulation for lighting fixtures, this LED power supply can only be used behind a switch without permanently connected to the mains. ※ Product Liability Disclaimer : For detailed information, please refer to <a href="https://www.meanwell.com/serviceDisclaimer.aspx">https://www.meanwell.com/serviceDisclaimer.aspx</a>			

■ BLOCK DIAGRAM

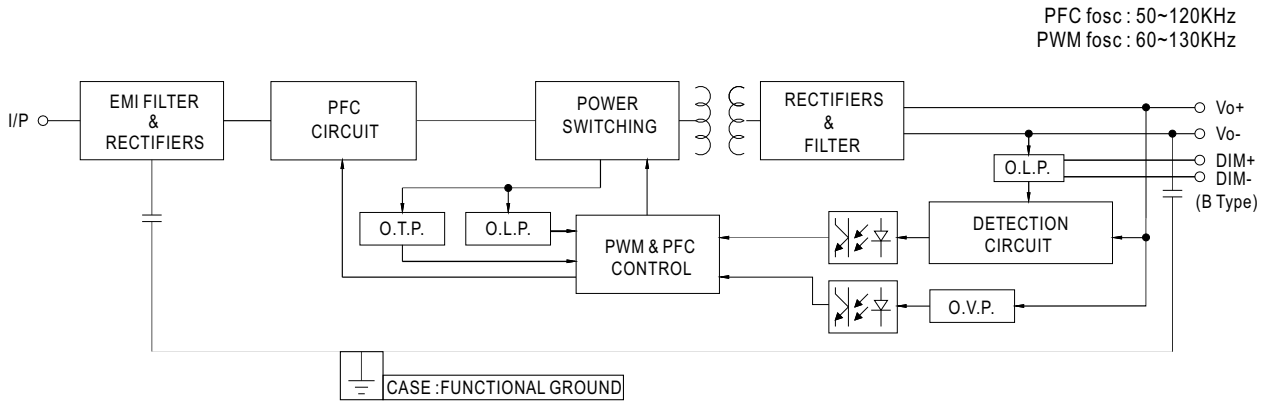

■ DRIVING METHODS OF LED MODULE

※ This series works in constant current mode to directly drive the LEDs.

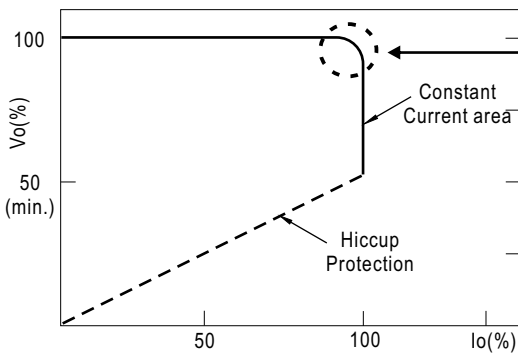

Typical output current normalized by rated current (%)

In the constant current region, the highest voltage at the output of the driver depends on the configuration of the end systems.  
Should there be any compatibility issues, please contact MEAN WELL.

© This characteristic applies to Blank/A/B/AB/D2-Type,  
For DA-Type, the Constant Current area is 60%~100% Vo.

## ■ DIMMING OPERATION

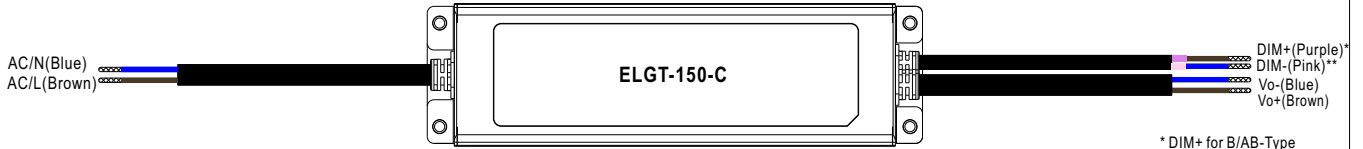

\* DIM+ for B/AB-Type  
 DA+ for DA-Type  
 PROG for D2-Type  
 \*\* DIM- for B/AB-Type  
 DA- for DA-Type  
 PROG- for D2-Type

### ※ 3 in 1 dimming function (for B/AB-Type)

Output constant current level can be adjusted by applying one of the three methodologies between DIM+ and DIM-:  
 0 ~ 10VDC, or 10V PWM signal or resistance.  
 Direct connecting to LEDs is suggested. It is not suitable to be used with additional drivers.  
 Dimming source current from power supply: 100 $\mu$ A (typ.)

#### ◎ Applying additive 0 ~ 10VDC



#### ◎ Applying additive 10V PWM signal (frequency range 100Hz ~ 3KHz):

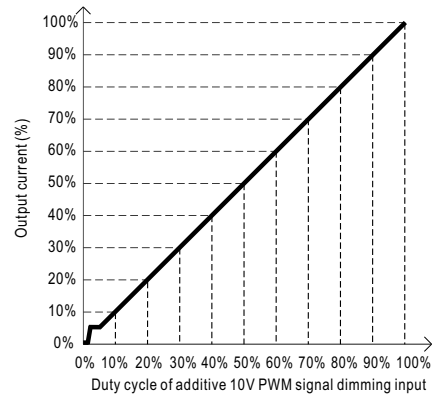

#### ◎ Applying additive resistance:

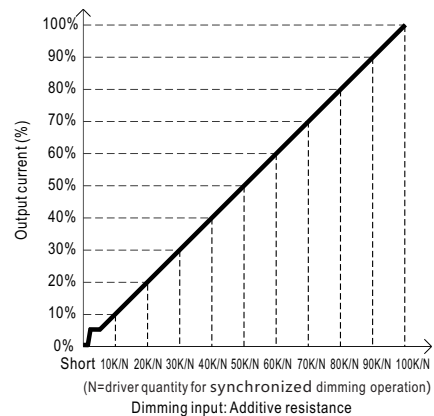

Note : 1. Min. dimming level is about 8% and the output current is not defined when 0% < I<sub>out</sub> < 8%.  
 2. The output current could drop down to 0% when dimming input is about 0kΩ or 0Vdc, or 10V PWM signal with 0% duty cycle.

※ **DALI Interface (primary side; for DA-Type)**

- Apply DALI signal between DA+ and DA-.
- DALI protocol comprises 16 groups and 64 addresses.
- First step is fixed at 8% of output.

※ **Smart timer dimming function (for D2-Type by User definition)**

MEAN WELL Smart timer dimming primarily provides the adaptive proportion dimming profile for the output constant current level to perform up to 14 consecutive hours. 3 dimming profiles hereunder are defined accounting for the most frequently seen applications. If other options may be needed, please contact MEAN WELL for details.

Ex : ◉ D01-Type: the profile recommended for residential lighting



Set up for D01-Type in Smart timer dimming software program:

	T1	T2	T3	T4
TIME**	06:00	07:00	11:00	---
LEVEL**	100%	70%	50%	70%

\*\* : TIME matches Operating Time in the diagram whereas LEVEL matches Dimming Level.

Example: If a residential lighting application adopts D01-Type, when turning on the power supply at 6:00pm, for instance:

- [1] The power supply will switch to the constant current level at 100% starting from 6:00pm.
- [2] The power supply will switch to the constant current level at 70% in turn, starting from 0:00am, which is 06:00 after the power supply turns on.
- [3] The power supply will switch to the constant current level at 50% in turn, starting from 1:00am, which is 07:00 after the power supply turns on.
- [4] The power supply will switch to the constant current level at 70% in turn, starting from 5:00am, which is 11:00 after the power supply turns on.

The constant current level remains till 8:00am, which is 14:00 after the power supply turns on.

Ex : ◉ D02-Type: the profile recommended for street lighting

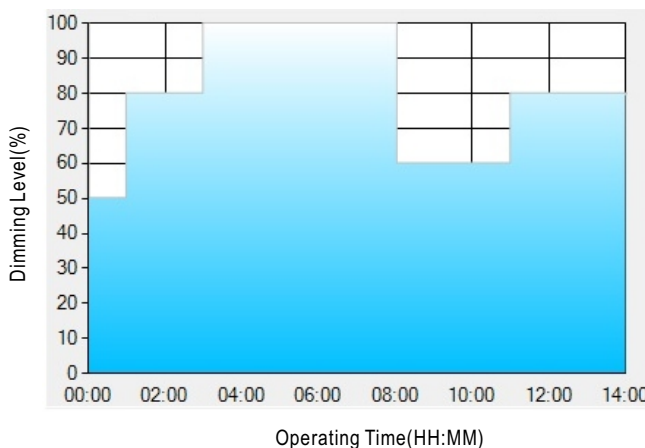

Set up for D02-Type in Smart timer dimming software program:

	T1	T2	T3	T4	T5
TIME**	01:00	03:00	8:00	11:00	---
LEVEL**	50%	80%	100%	60%	80%

\*\* : TIME matches Operating Time in the diagram whereas LEVEL matches Dimming Level.

Example: If a street lighting application adopts D02-Type, when turning on the power supply at 5:00pm, for instance:

- [1] The power supply will switch to the constant current level at 50% starting from 5:00pm.
- [2] The power supply will switch to the constant current level at 80% in turn, starting from 6:00pm, which is 01:00 after the power supply turns on.
- [3] The power supply will switch to the constant current level at 100% in turn, starting from 8:00pm, which is 03:00 after the power supply turns on.
- [4] The power supply will switch to the constant current level at 60% in turn, starting from 1:00am, which is 08:00 after the power supply turns on.
- [5] The power supply will switch to the constant current level at 80% in turn, starting from 4:00am, which is 11:00 after the power supply turns on. The constant current level remains till 6:30am, which is 14:00 after the power supply turns on.

Ex: © D03-Type: the profile recommended for tunnel lighting

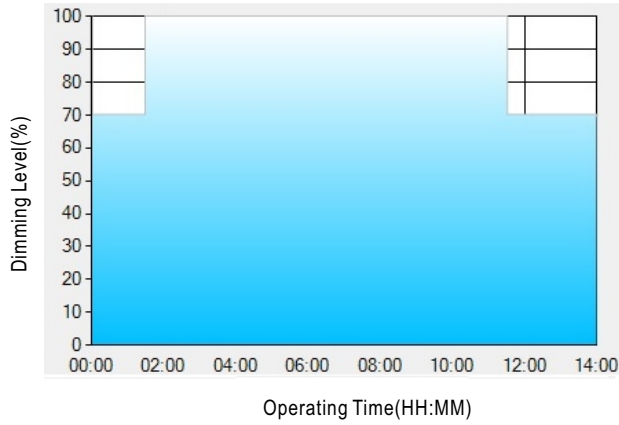

Set up for D03-Type in Smart timer dimming software program:

	T1	T2	T3
TIME**	01:30	11:00	---
LEVEL**	70%	100%	70%

\*\* : TIME matches Operating Time in the diagram whereas LEVEL matches Dimming Level.

Example: If a tunnel lighting application adopts D03-Type, when turning on the power supply at 4:30pm, for instance:

[1] The power supply will switch to the constant current level at 70% starting from 4:30pm.

[2] The power supply will switch to the constant current level at 100% in turn, starting from 6:00pm, which is 01:30 after the power supply turns on.

[3] The power supply will switch to the constant current level at 70% in turn, starting from 5:00am, which is 11:00 after the power supply turns on.

The constant current level remains till 6:30am, which is 14:00 after the power supply turns on.

**OUTPUT LOAD vs TEMPERATURE(NOTE 7.)**

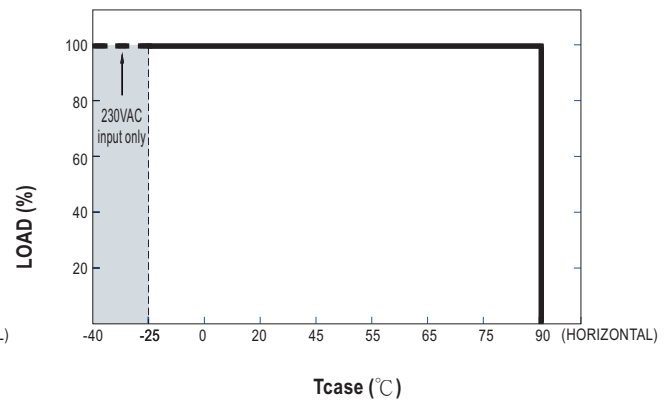
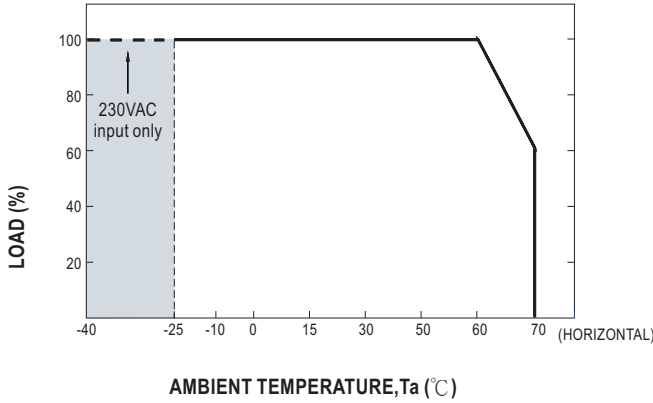

**STATIC CHARACTERISTIC**

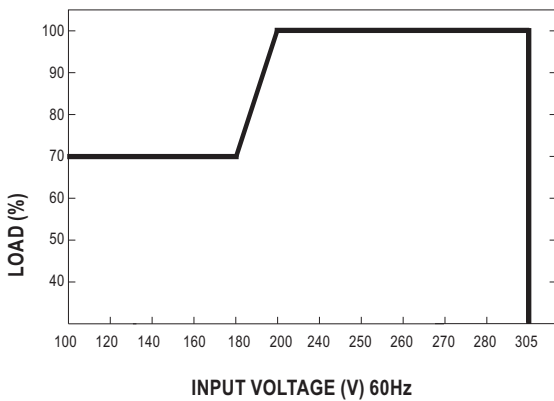

※De-rating is needed under low input voltage.

**POWER FACTOR (PF) CHARACTERISTIC**

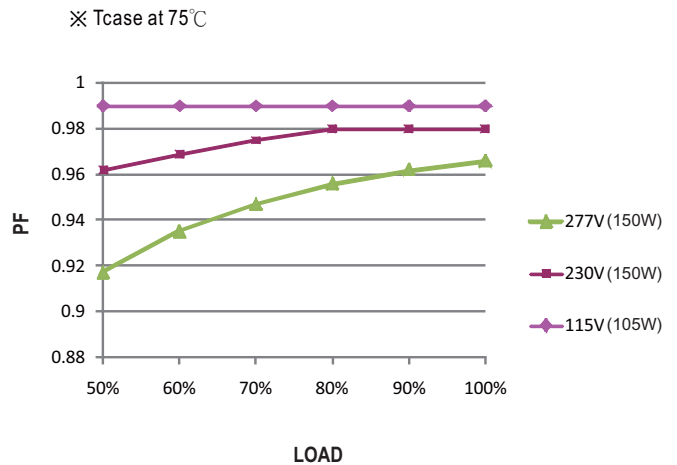

**TOTAL HARMONIC DISTORTION (THD)**

※ 700mA Model, Tcase at 75°C

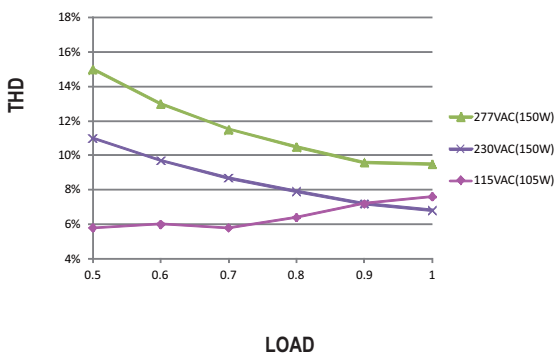

**EFFICIENCY vs LOAD**

ELGT-150-C series possess superior working efficiency that up to 92% can be reached in field applications.

※ 700mA Model, Tcase at 75°C

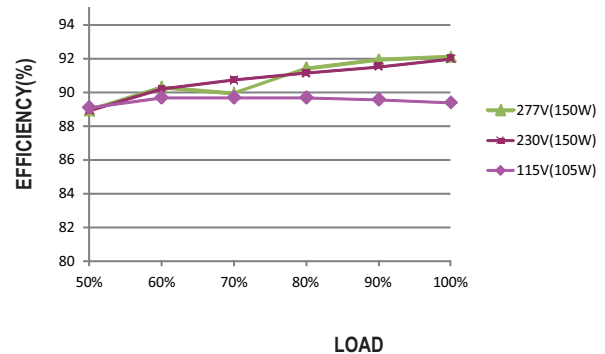



■ LIFE TIME

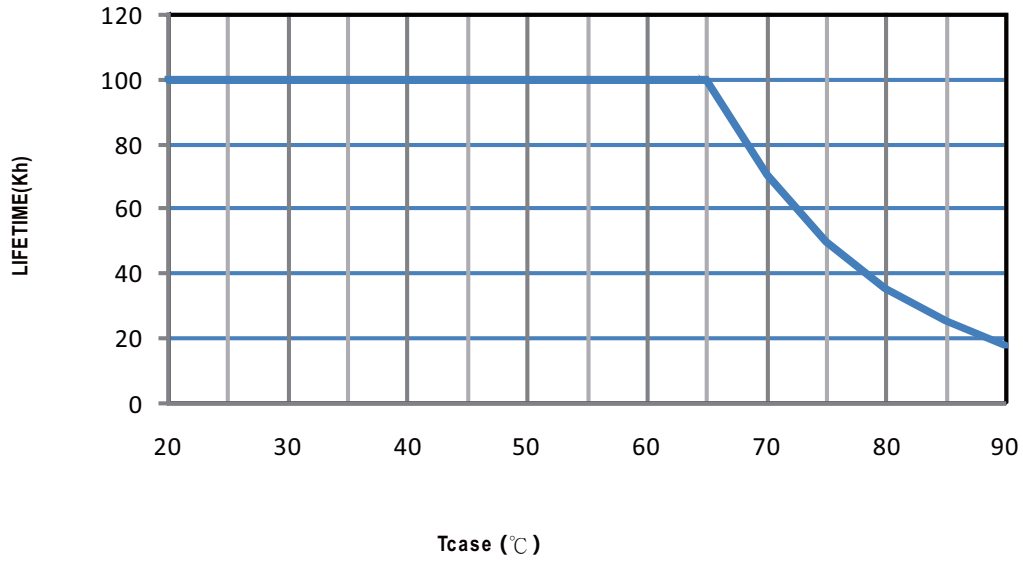



MECHANICAL SPECIFICATION

※ Blank-Type

CASE NO.: 237A Unit:mm Tolerance:±1

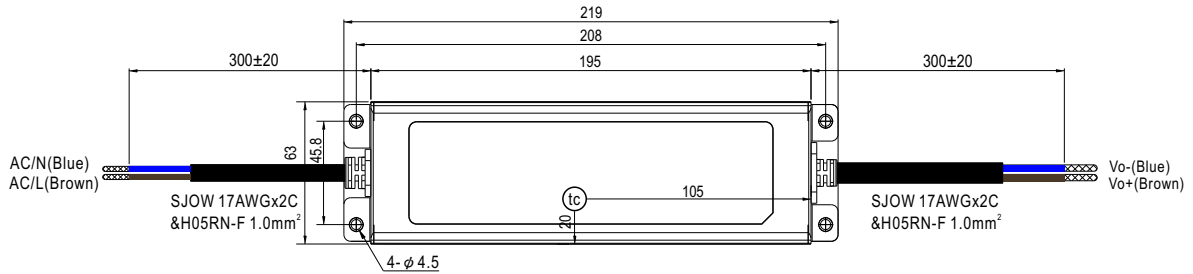

·(tc) : Max. Case Temperature

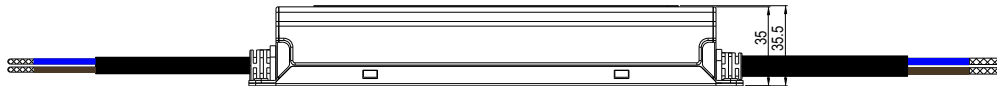

※ B/DA/D2-Type

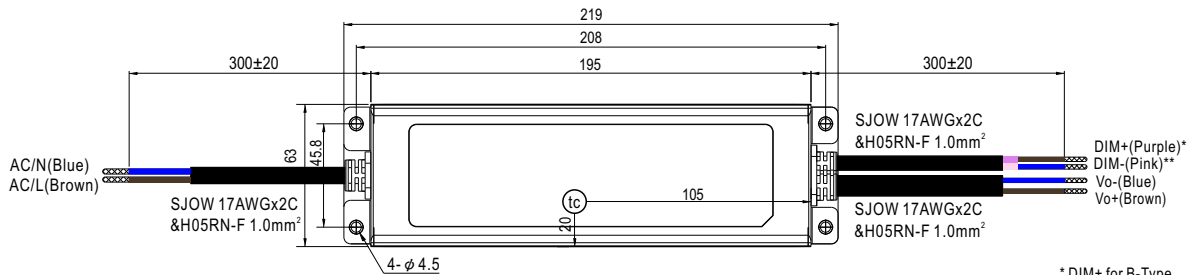

·(tc) : Max. Case Temperature

\* DIM+ for B-Type  
DA+ for DA-Type  
PROG+ for D2-Type  
\* DIM- for B-Type  
DA- for DA-Type  
PROG- for D2-Type



※ **A-Type**

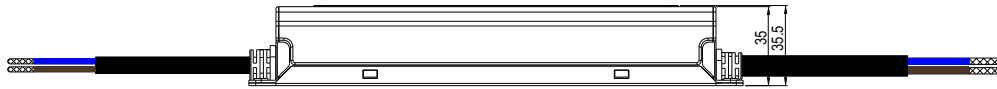
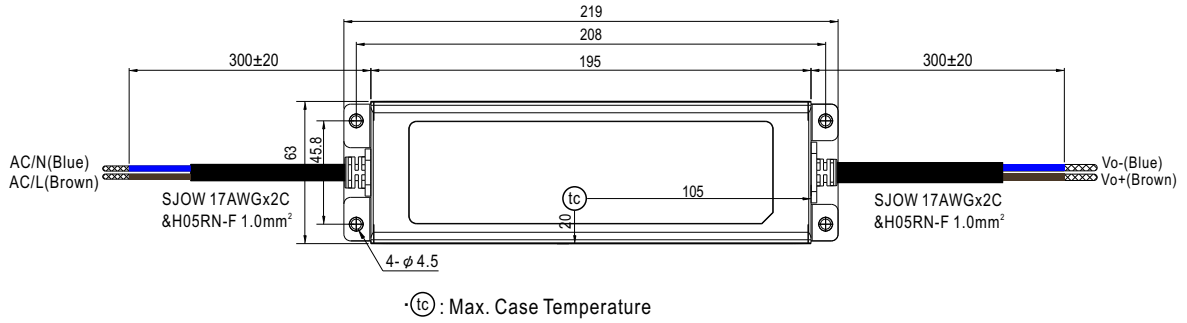

※ **AB-Type**

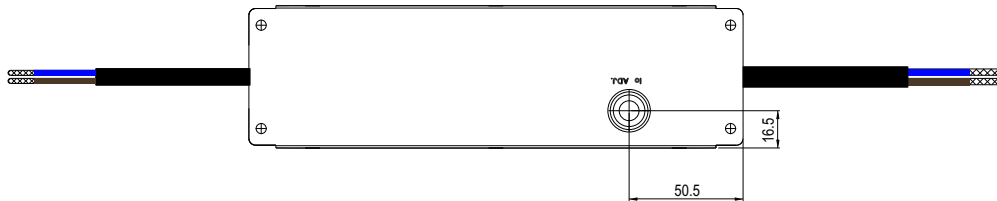
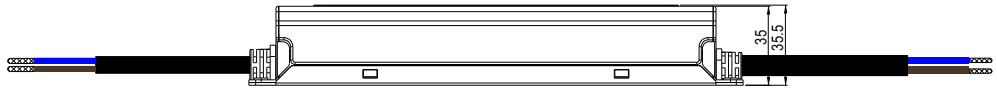
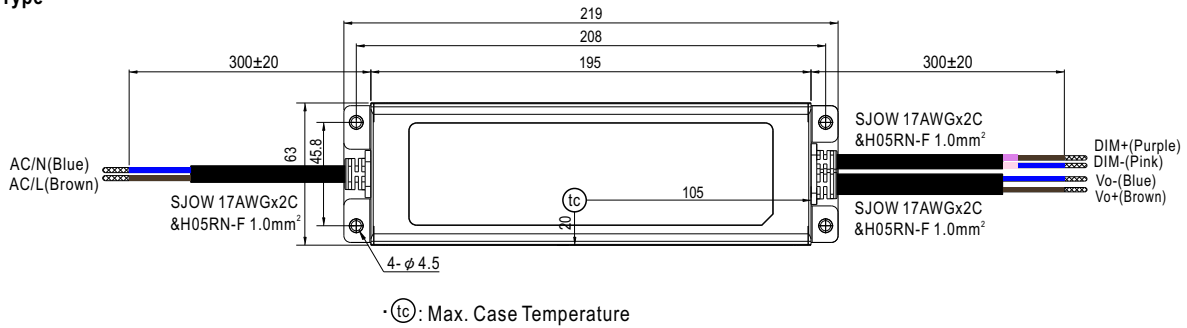

■ **MANUAL INSTALLATION**

Please refer to : <http://www.meanwell.com/manual.html>