



Features

- Wide input range 180 ~ 528VAC
- Constant Current mode output
- Metal housing with Class I design
- Built-in active PFC function
- IP67 / IP65 design for indoor or outdoor installations
- Function options: output adjustable via potentiometer; 3 in 1 dimming (dim-to-off) ; Smart timer dimming
- Typical lifetime > 50000 hours
- 5 years warranty

Applications

- LED street lighting
- LED high-bay lighting
- Parking space lighting
- LED fishing lamp
- Type "HL" for use in Class I , Division 2 hazardous (Classified) location.

GTIN CODE

MW Search: <https://www.meanwell.com/serviceGTIN.aspx>

Description

HVGC-240 series is a 240W LED AC/DC LED power supply featuring the constant current mode and high voltage output. HVGC-240 operates from 180~528VAC and offers models with different rated current ranging between 700mA and 3500mA. Thanks to the high efficiency up to 93.5%, with the fanless design, the entire series is able to operate for -40°C ~ +90°C case temperature under free air convection. The design of metal housing and IP67/IP65 ingress protection level allows this series to fit both indoor and outdoor applications. HVGC-240 is equipped with various function options, such as dimming methodologies, so as to provide the optimal design flexibility for LED lighting system.

Model Encoding

HVGC - 240 - 1750 A

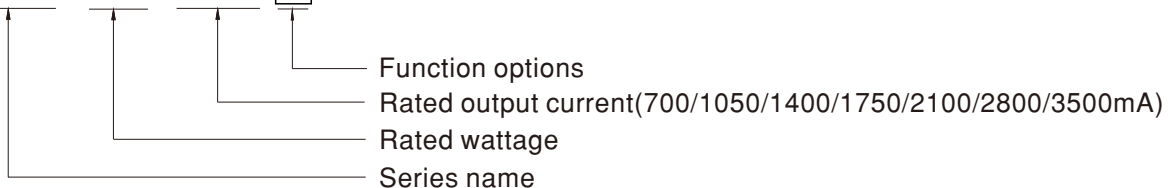

Type	IP Level	Function	Note
A	IP65	Io adjustable through built-in potentiometer.	In Stock
B	IP67	3 in 1 dimming function (0~10Vdc, 10V PWM signal and resistance)	In Stock
AB	IP65	Io adjustable through built-in potentiometer & 3 in 1 dimming function (0~10Vdc, 10V PWM signal and resistance)	In Stock
Dx	IP67	Built-in Smart timer dimming function by user request.	By request
D2	IP67	Built-in Smart timer dimming and programmable function.	By request



SPECIFICATION

MODEL		HVGC-240-700 <input type="checkbox"/>	HVGC-240-1050 <input type="checkbox"/>	HVGC-240-1400 <input type="checkbox"/>	HVGC-240-1750 <input type="checkbox"/>	HVGC-240-2100 <input type="checkbox"/>	HVGC-240-2800 <input type="checkbox"/>	HVGC-240-3500 <input type="checkbox"/>
OUTPUT	RATED CURRENT	700mA	1050mA	1400mA	1750mA	2100mA	2800mA	3500mA
	RATED POWER	240W	240W	240W	240W	240W	240W	240.1W
	CONSTANT CURRENT REGION Note.2	171.4 ~ 342.8V	114.3 ~ 228.6V	85.7 ~ 171.4V	68.5 ~ 137.1V	57.2 ~ 114.3V	42.9 ~ 85.7V	34.3 ~ 68.6V
	OPEN CIRCUIT VOLTAGE (max.)	354V	235V	176V	141V	117V	88V	71V
	CURRENT ADJ. RANGE	Adjustable for A/AB-Type only (via built-in potentiometer)						
		350~700mA	525~1050mA	700~1400mA	875~1750mA	1050~2100mA	1400~2800mA	1750~3500mA
	CURRENT RIPPLE	5.0% max. @rated current						
	CURRENT TOLERANCE	±5%						
SET UP TIME Note.4	500ms/230VAC, 347VAC, 480VAC							
INPUT	VOLTAGE RANGE Note.3	180 ~ 528VAC 254VDC ~ 747VDC (Please refer to "STATIC CHARACTERISTIC" section)						
	FREQUENCY RANGE	47 ~ 63Hz						
	POWER FACTOR (Typ.)	PF ≥ 0.98/230VAC, PF ≥ 0.97/277VAC, PF ≥ 0.95/347VAC, PF ≥ 0.93/480VAC @full load (Please refer to "POWER FACTOR (PF) CHARACTERISTIC" section)						
	TOTAL HARMONIC DISTORTION	THD < 20% (@ load ≥ 50%/230VAC, 277VAC, 347VAC, @ load ≥ 60%/480VAC) (Please refer to "TOTAL HARMONIC DISTORTION (THD)" section)						
	EFFICIENCY (Typ.)	93.5%	93%	93%	93%	92.5%	92.5%	92.5%
	AC CURRENT (Typ.)	0.76A / 347VAC 0.56A / 480VAC						
	INRUSH CURRENT(Typ.)	COLD START 50A(twidth= 532μs measured at 50% Ipeak) at 480VAC; Per NEMA 410						
	MAX. NO. of PSUs on 16A CIRCUIT BREAKER	4unit(circuit breaker of type B) / 6units(circuit breaker of type C) at 480VAC						
LEAKAGE CURRENT	<0.75mA / 480VAC							
PROTECTION	SHORT CIRCUIT	Constant current limiting, recovers automatically after fault condition is removed						
	OVER VOLTAGE	360 ~ 394V	240 ~ 263V	180 ~ 197V	144 ~ 158V	120 ~ 131.4V	90 ~ 99V	72 ~ 79V
	OVER TEMPERATURE	Shut down o/p voltage with re-power on to recovery Shut down and latch off o/p voltage, re-power on to recover						
ENVIRONMENT	WORKING TEMP.	Tcase=-40 ~ +90°C (Please refer to "OUTPUT LOAD vs TEMPERATURE" section)						
	MAX. CASE TEMP.	Tcase=+90°C						
	WORKING HUMIDITY	20 ~ 95% RH non-condensing						
	STORAGE TEMP., HUMIDITY	-40 ~ +80°C, 10 ~ 95% RH						
	TEMP. COEFFICIENT	±0.03%/°C (0 ~ 60°C)						
VIBRATION	10 ~ 500Hz, 5G 12min./1cycle, period for 72min. each along X, Y, Z axes							
SAFETY & EMC	SAFETY STANDARDS	UL8750 (type"HL"), CSA C22.2 No. 250.13-12, IEC/BS EN/EN61347-1,IEC/BS EN/EN61347-2-13, BS EN/EN62384 independent, EAC TP TC 004, IP65 or IP67 approved						
	WITHSTAND VOLTAGE	I/P-O/P:3.75KVAC I/P-FG:2KVAC O/P-FG:1.5KVAC						
	ISOLATION RESISTANCE	I/P-O/P, I/P-FG, O/P-FG:100M Ohms / 500VDC / 25°C / 70% RH						
	EMC EMISSION	Compliance to FCC Part 15 Subpart B, BS EN/EN55015, BS EN/EN61000-3-2(@load ≥ 80%), BS EN/EN61000-3-3, EAC TP TC 020						
EMC IMMUNITY	Compliance to BS EN/EN61000-4-2,3,4,5,6,8,11, BS EN/EN61547, light industry level (surge immunity Line-Earth 4KV, Line-Line 2KV), EAC TP TC 020							
OTHERS	MTBF	1769.1K hrs min. Telcordia SR-332 (Bellcore) ; 145.2K hrs min. MIL-HDBK-217F (25°C)						
	DIMENSION	254.2*68*38.8mm (L*W*H)						
	PACKING	1.35Kg; 12pcs/17.2Kg/0.78CUFT						
NOTE	<ol style="list-style-type: none"> All parameters NOT specially mentioned are measured at 347VAC input, rated current and 25°C of ambient temperature. Please refer to "DRIVING METHODS OF LED MODULE". De-rating may be needed under low input voltages. Please refer to "STATIC CHARACTERISTIC" sections for details. Length of set up time is measured at first cold start. Turning ON/OFF the power supply may lead to increase of the set up time. The driver is considered as a component that will be operated in combination with final equipment. Since EMC performance will be affected by the complete installation, the final equipment manufacturers must re-qualify EMC Directive on the complete installation again. (as available on https://www.meanwell.com/Upload/PDF/EMI_statement_en.pdf) This series meets the typical life expectancy of >50,000 hours of operation when Tcase, particularly (tc) point (or TMP, per DLC), is about 80°C or less. Please refer to the warranty statement on MEAN WELL's website at http://www.meanwell.com. The ambient temperature derating of 3.5°C/1000m with fanless models and of 5°C/1000m with fan models for operating altitude higher than 2000m(6500ft). For any application note and IP water proof function installation caution, please refer our user manual before using. https://www.meanwell.com/Upload/PDF/LED_EN.pdf To fulfill requirements of the latest ErP regulation for lighting fixtures, this LED power supply can only be used behind a switch without permanently connected to the mains. For A/AB type need to consider build in using to comply with Type HL application. <p>※ Product Liability Disclaimer : For detailed information, please refer to https://www.meanwell.com/serviceDisclaimer.aspx</p>							

Block Diagram

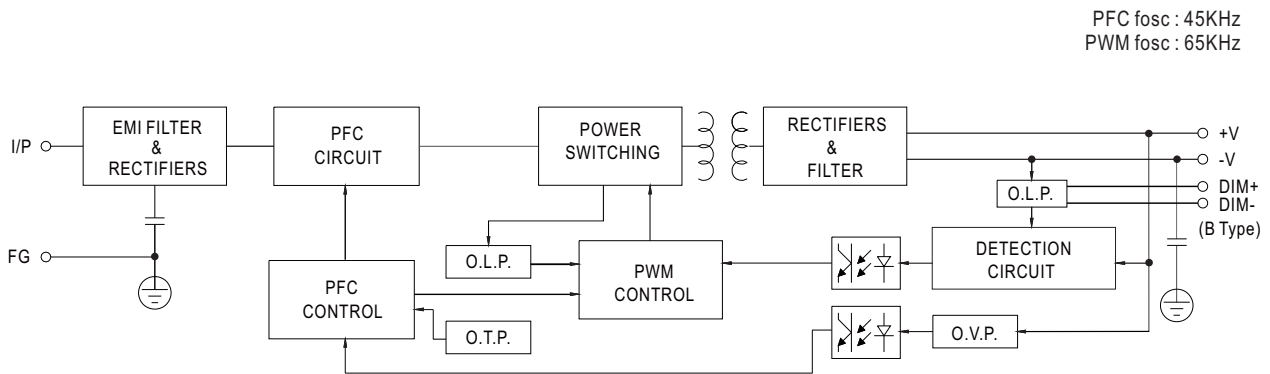

DRIVING METHODS OF LED MODULE

※ This series works in constant current mode to directly drive the LEDs.

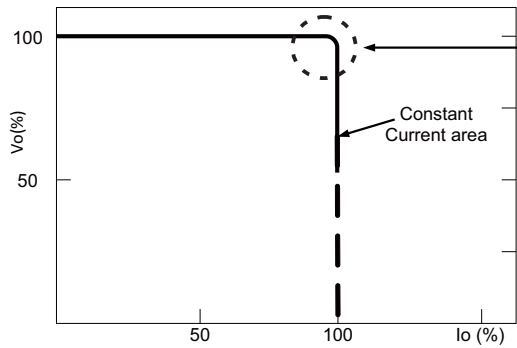

Typical output current normalized by rated current (%)

In the constant current region, the highest voltage at the output of the driver depends on the configuration of the end systems.

Should there be any compatibility issues, please contact MEAN WELL.

DIMMING OPERATION

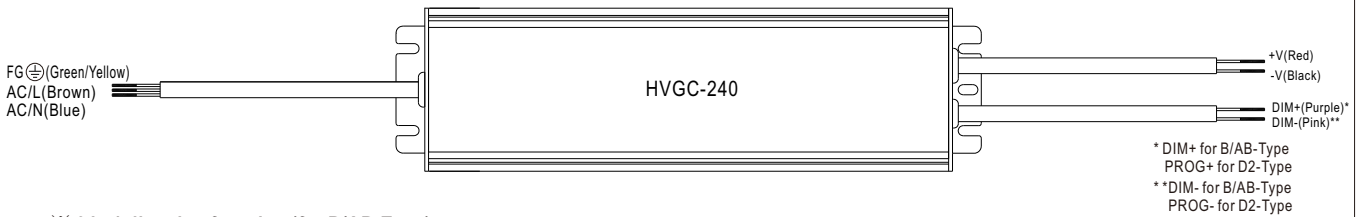

※ 3 in 1 dimming function (for B/AB-Type)

- Output constant current level can be adjusted by applying one of the three methodologies between DIM+ and DIM-:
0 ~ 10VDC, or 10V PWM signal or resistance.
- Direct connecting to LEDs is suggested. It is not suitable to be used with additional drivers.
- Dimming source current from power supply: 100 μ A (typ.)

◎ Applying additive 0 ~ 10VDC

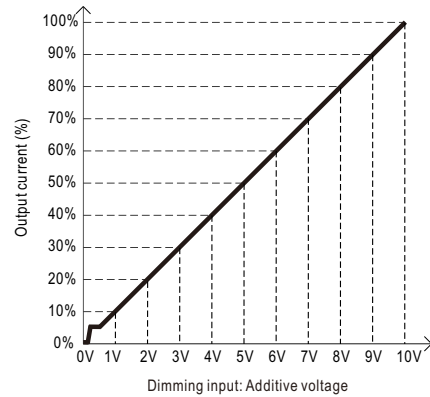

◎ Applying additive 10V PWM signal (frequency range 100Hz ~ 3KHz):

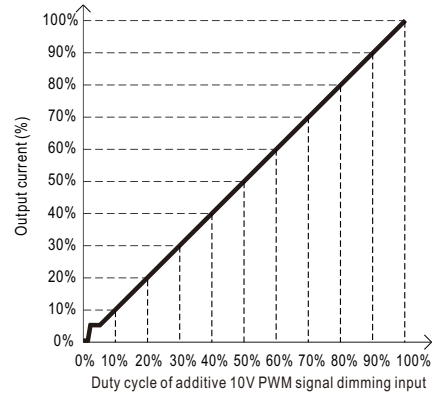
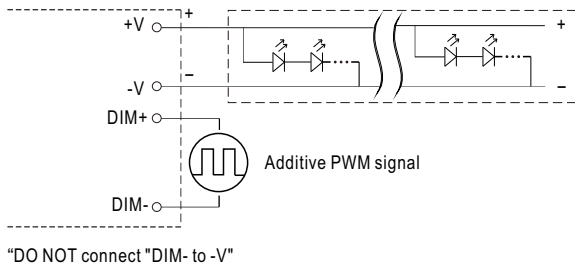

◎ Applying additive resistance:

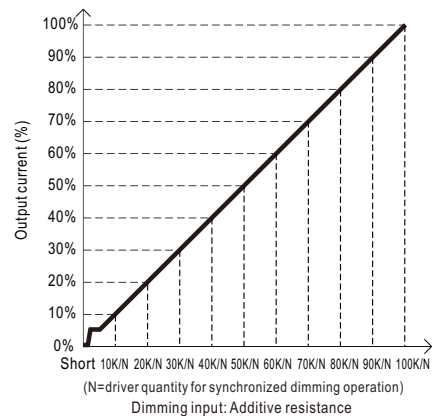
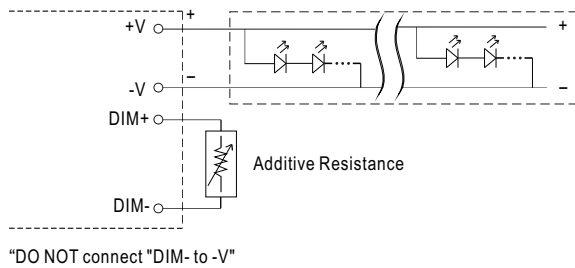

- Note : 1. Min. dimming level is about 5% and the output current is not defined when $0\% < I_{out} < 5\%$.
2. The output current could drop down to 0% when dimming input is about $0k\Omega$ or 0Vdc, or 10V PWM signal with 0% duty cycle.

※ **Smart timer dimming function (for Dxx-Type by User definition)**

MEAN WELL Smart timer dimming primarily provides the adaptive proportion dimming profile for the output constant current level to perform up to 14 consecutive hours. 3 dimming profiles hereunder are defined accounting for the most frequently seen applications. If other options may be needed, please contact MEAN WELL for details.

Ex : ☉ D01-Type: the profile recommended for residential lighting

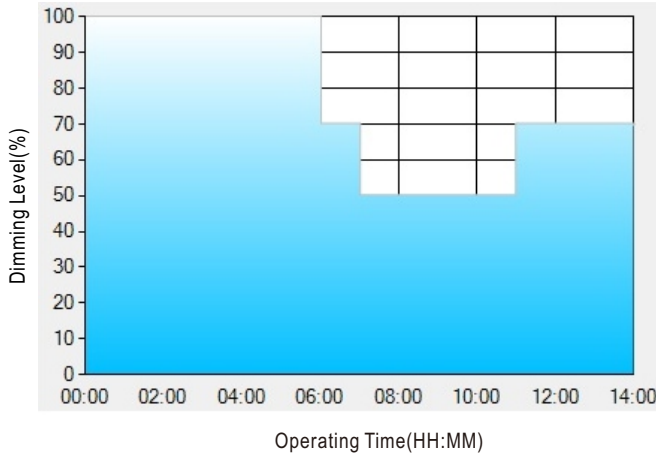

Set up for D01-Type in Smart timer dimming software program:

	T1	T2	T3	T4
TIME**	06:00	07:00	11:00	---
LEVEL**	100%	70%	50%	70%

** : TIME matches Operating Time in the diagram whereas LEVEL matches Dimming Level.

Example: If a residential lighting application adopts D01-Type, when turning on the power supply at 6:00pm, for instance:

- [1] The power supply will switch to the constant current level at 100% starting from 6:00pm.
 - [2] The power supply will switch to the constant current level at 70% in turn, starting from 0:00am, which is 06:00 after the power supply turns on.
 - [3] The power supply will switch to the constant current level at 50% in turn, starting from 1:00am, which is 07:00 after the power supply turns on.
 - [4] The power supply will switch to the constant current level at 70% in turn, starting from 5:00am, which is 11:00 after the power supply turns on.
- The constant current level remains till 8:00am, which is 14:00 after the power supply turns on.

Ex : ☉ D02-Type: the profile recommended for street lighting

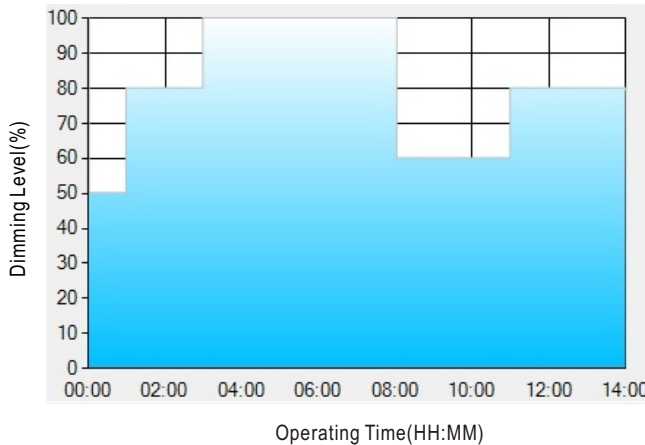

Set up for D02-Type in Smart timer dimming software program:

	T1	T2	T3	T4	T5
TIME**	01:00	03:00	8:00	11:00	---
LEVEL**	50%	80%	100%	60%	80%

** : TIME matches Operating Time in the diagram whereas LEVEL matches Dimming Level.

Example: If a street lighting application adopts D02-Type, when turning on the power supply at 5:00pm, for instance:

- [1] The power supply will switch to the constant current level at 50% starting from 5:00pm.
- [2] The power supply will switch to the constant current level at 80% in turn, starting from 6:00pm, which is 01:00 after the power supply turns on.
- [3] The power supply will switch to the constant current level at 100% in turn, starting from 8:00pm, which is 03:00 after the power supply turns on.
- [4] The power supply will switch to the constant current level at 60% in turn, starting from 1:00am, which is 08:00 after the power supply turns on.
- [5] The power supply will switch to the constant current level at 80% in turn, starting from 4:00am, which is 11:00 after the power supply turns on. The constant current level remains till 6:30am, which is 14:00 after the power supply turns on.

Ex: © D03-Type: the profile recommended for tunnel lighting

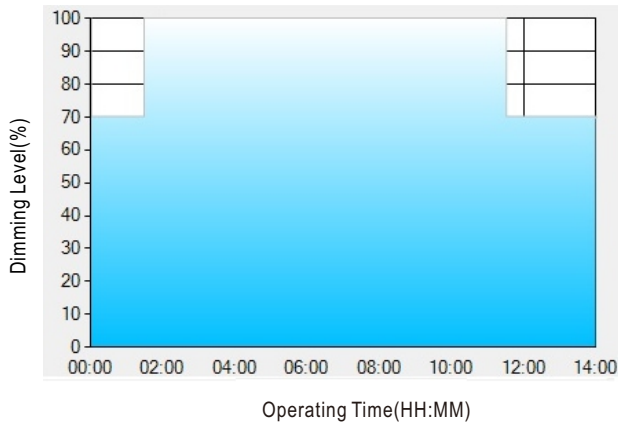

Set up for D03-Type in Smart timer dimming software program:

	T1	T2	T3
TIME**	01:30	11:00	---
LEVEL**	70%	100%	70%

** : TIME matches Operating Time in the diagram whereas LEVEL matches Dimming Level.

Example: If a tunnel lighting application adopts D03-Type, when turning on the power supply at 4:30pm, for instance:

[1] The power supply will switch to the constant current level at 70% starting from 4:30pm.

[2] The power supply will switch to the constant current level at 100% in turn, starting from 6:00pm, which is 01:30 after the power supply turns on.

[3] The power supply will switch to the constant current level at 70% in turn, starting from 5:00am, which is 11:00 after the power supply turns on.

The constant current level remains till 6:30am, which is 14:00 after the power supply turns on.

OUTPUT LOAD vs TEMPERATURE(Not.7)

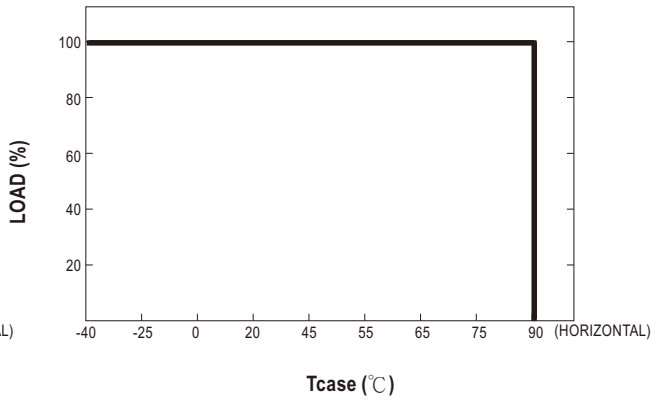
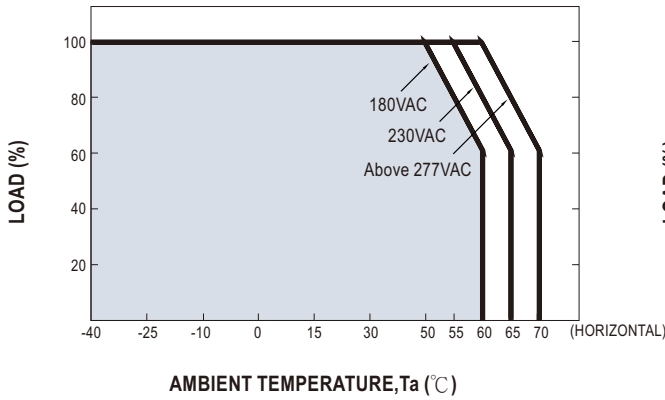

STATIC CHARACTERISTIC

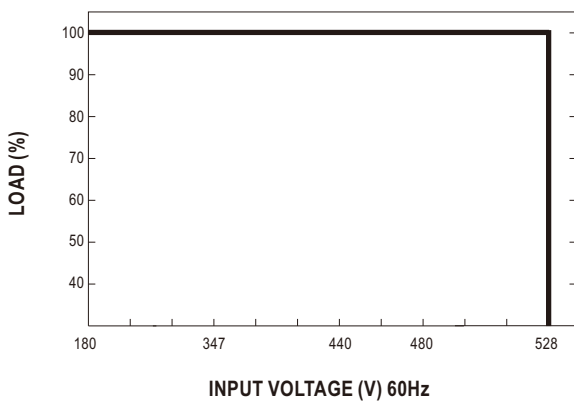

POWER FACTOR (PF) CHARACTERISTIC

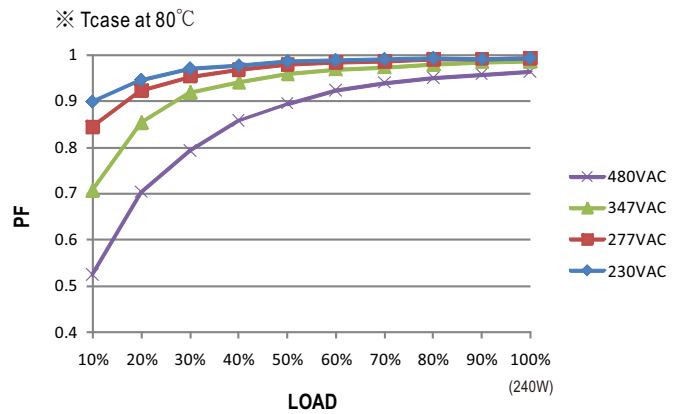

TOTAL HARMONIC DISTORTION (THD)

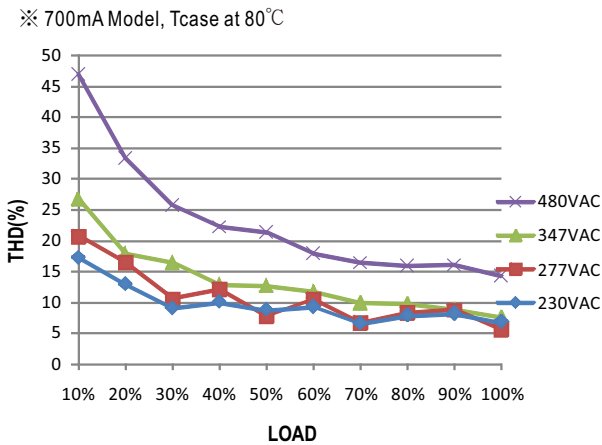

EFFICIENCY vs LOAD

HVGC-240 series possess superior working efficiency that up to 93.5% can be reached in field applications.

※ 700mA Model, Tcase at 80°C

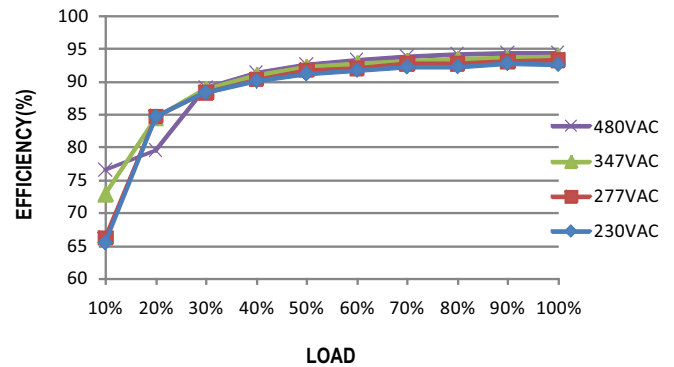



■ LIFE TIME

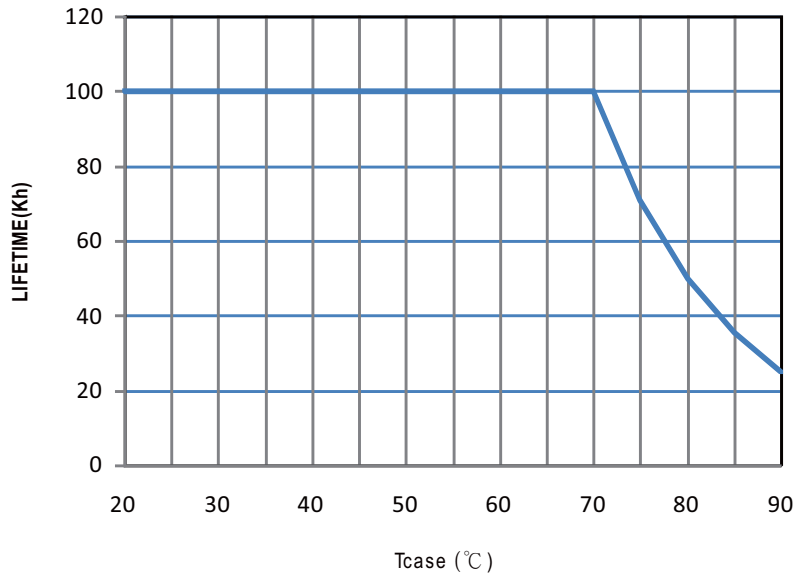

MECHANICAL SPECIFICATION

Case No. 994 Unit:mm Tolerance:±1

※ A-Type

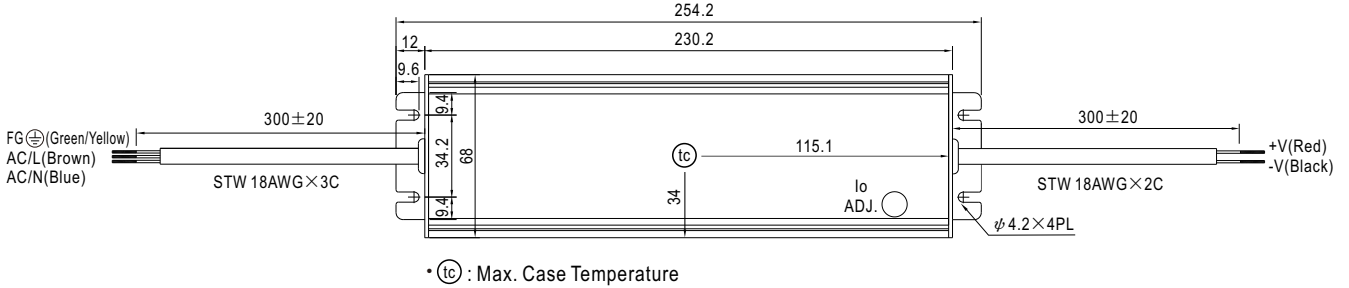

※ AB-Type

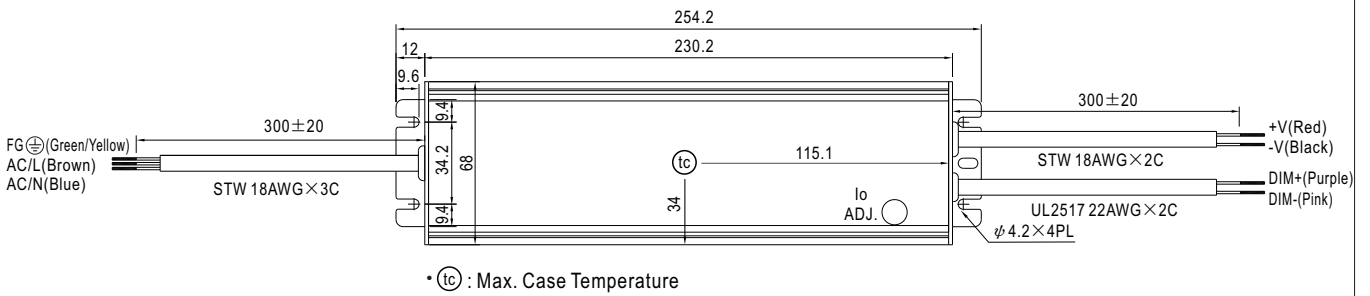

※ B/D2-Type

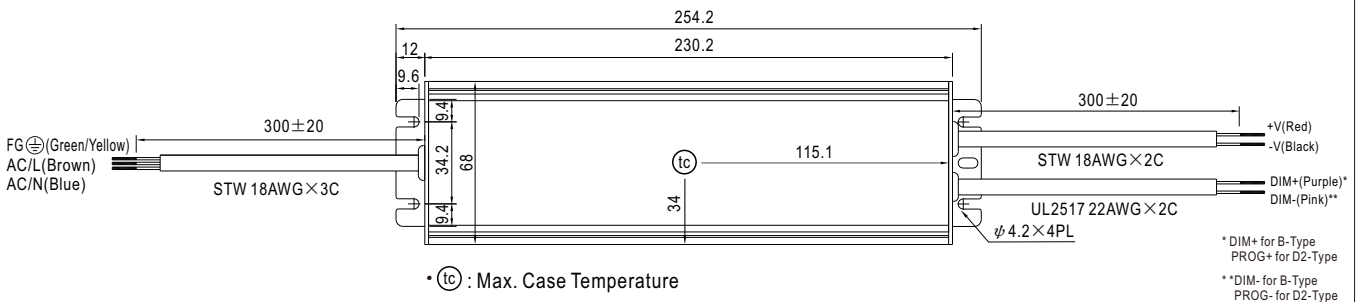

INSTALLATION MANUAL

Please refer to : <http://www.meanwell.com/manual.html>