

GlobTek, Inc. www.globtek.com 186 Veterans Drive, Northvale, NJ 07647 Tel. (201) 784-1000 Fax (201) 784-0111	Drawing Title: GTM96600-6024-R2, ICT / ITE / Medical Power Supply/Class 2/Household Power Supply, Efficiency Level: USA DOE Level VI / Eco-design Directive 2009/125/EC, (EU) 2019/1782, Case Color/Style: GlobTek Black, Wall Plug-in+Desktop Combination, Regulated Switchmode AC-DC Power Supply AC Adaptor, Input Rating: 100-240V~, 50-60 Hz, IEC 60320/C8 w/ Wall Blades Option, , Output Rating: 60.00W, 24.0V@2.5A, Pin Out: Center Positive (+V), symbol compliant with IEC 60417 symbol no. 5926, Output Configuration: 1200 mm, 16/1C + Shield Cond, UL 1185, Female Barrel 5.5*2.1*11mm w/ Spring Clip & Locking Notch or Equal, Ferrite: Core Size: RH 14.2*28.5*10, GlobTek Black, GT Cord # C4670, Blades/Input Cord: (Order Separately), Approvals:	
	Model No. GTM96600-6024-R2	
	Part No./Ordering No. RR9KI2500CCPCIMR6B	Rev E

In Addition to GlobTek Inc.'s renewed ISO9001:2015 - Quality Management System Certification, GlobTek Inc. is now certified to:

ISO13485:2016 - Medical Devices Quality Management System Certification
ISO14001:2015 - Environmental Management System Certification

ISO Certificates are available online at <https://www.globtek.com/iso-certificates/>

The acceptance of this specification and use of the product described in this document indicates the acceptance and binding of the customer to Globtek TERMS AND CONDITIONS (attached to the end of this document), which supersede all other agreements, terms, and conditions (<https://www.globtek.com/terms-and-conditions/>).

The purchaser of this product (Customer) agrees that it is their sole responsibility to determine suitability/fitness of the product described in this specification for their application and to take precautions for protection against any hazards attendant to the handling and use of the product.

Footnote:

GlobTek Inc. will not be liable for the safety and performance of these power supplies/battery packs if unauthorized access and repair occurs. End user should consult applicable UL, CSA or EN standards for proper installation instruction.

Limitation of Use:

GlobTek products are intended for use with commercial, medical, and/or industrial equipment only. GlobTek product are not authorized for use as mission critical components in life support hazardous environment, nuclear or aircraft applications without prior written approval from the CEO of GlobTek Inc.

Contents of this document are subject to change without prior notice.

Customer Approval of Specification:

Please approve, sign and send back to GlobTek so we can complete order processing.
A delay in receipt of this form will delay delivery schedule.

Company Name: _____	Customer P/N: _____
Quote Number: _____	Date: _____
Authorized Representative Name: _____	Authorized Representative Signature: _____

GlobTek, Inc. www.globtek.com 186 Veterans Drive, Northvale, NJ 07647 Tel. (201) 784-1000 Fax (201) 784-0111	Drawing Title: GTM96600-6024-R2, ICT / ITE / Medical Power Supply/Class 2/Household Power Supply, Efficiency Level: USA DOE Level VI / Eco-design Directive 2009/125/EC, (EU) 2019/1782, Case Color/Style: GlobTek Black, Wall Plug-in+Desktop Combination, Regulated Switchmode AC-DC Power Supply AC Adaptor, Input Rating: 100-240V~, 50-60 Hz, IEC 60320/C8 w/ Wall Blades Option, , Output Rating: 60.00W, 24.0V@2.5A, Pin Out: Center Positive (+V), symbol compliant with IEC 60417 symbol no. 5926, Output Configuration: 1200 mm, 16/1C + Shield Cond, UL 1185, Female Barrel 5.5*2.1*11mm w/ Spring Clip & Locking Notch or Equal, Ferrite: Core Size: RH 14.2*28.5*10, GlobTek Black, GT Cord # C4670, Blades/Input Cord: (Order Separately), Approvals:	
	Model No. GTM96600-6024-R2	
	Part No./Ordering No. RR9KI2500CCPCIMR6B	Rev E

REVISION HISTORY

REV	DESCRIPTION	SUB	DATE	APPROVED
E	Update RoHS 2 to RoHS, Ukraine, add CCC,BOOK,LPS,ETL, EAC	QA	08/28/2018	QA
D	Update O/P ferrite cord size to RH 14.2*28.5*10	rchiu	12/07/2016	QA
C	Update O/P cord to ferrite with 2 pass	QA	06/24/2016	QA
B	Box Qty to 20, and Master Carton Size to 427*405*158mm	QA	03/30/2016	QA
A	Initial release.	emcna	12/11/2015	QA

POWER SUPPLY INFORMATION

TYPE	Wall Plug-in+Desktop Combination
TECHNOLOGY	Regulated Switchmode AC-DC Power Supply AC Adaptor
CASE COLOR	GlobTek Black
NAMEPLATE RATED INPUT	100-240V~, 50-60 Hz, 1.5 A
INPUT CONFIG	IEC 60320/C8 w/ Wall Blades Option
WATTS	60.00
VOLTS OUT	24.0
CURRENT OUT (Amps)	2.5
BLADE/CORD INCLUDED	None (Order Separately)
BLADE/CORD INSTALLED	None :(Order Separately)
INGRESS PROTECTION	IP40, IP54 Option available
GROUNDING CONFIGURATION	(F1) Floating output, Class II / double insulated
EFFICIENCY LEVEL	USA DOE Level VI / Eco-design Directive 2009/125/EC, (EU) 2019/1782 - Europe Code of Conduct on Energy Efficiency of External Power Supplies - Version 5
OUTPUT CONFIGURATION	1200 mm, 16/1C + Shield Cond, UL 1185, Female Barrel 5.5*2.1*11mm w/ Spring Clip & Locking Notch or Equal, Ferrite: Core Size: RH 14.2*28.5*10, GlobTek Black, GT Cord # C4670
CONNECTOR PIN OUT	Center Positive (+V), symbol compliant with IEC 60417 symbol no. 5926
LABEL SPECS	Standard GT,L-1186
SPECIAL BARCODE LABEL MATERIAL	No
PACK SPEC	Standard DT, Cellular packaging, User manual
USER MANUAL	809-DESKTOPUSERMANUAL on A4 paper

PROPRIETARY INFORMATION

PROPRIETARY OF GLOBTEK, INC. ANY REPRODUCTION, DISCLOSURE OR USE OF THIS DRAWING, IN WHOLE OR IN PART, IS HEREBY PROHIBITED EXCEPT AS SPECIFIED IN

WRITING BY GLOBTEK, INC. © GlobTek, Inc. 2015 - 2024

quest / 12/25/2024 4:24:10 AM GMT

GlobTek, Inc. www.globtek.com 186 Veterans Drive, Northvale, NJ 07647 Tel. (201) 784-1000 Fax (201) 784-0111	Drawing Title: GTM96600-6024-R2, ICT / ITE / Medical Power Supply/Class 2/Household Power Supply, Efficiency Level: USA DOE Level VI / Eco-design Directive 2009/125/EC, (EU) 2019/1782, Case Color/Style: GlobTek Black, Wall Plug-in+Desktop Combination, Regulated Switchmode AC-DC Power Supply AC Adaptor, Input Rating: 100-240V~, 50-60 Hz, IEC 60320/C8 w/ Wall Blades Option, , Output Rating: 60.00W, 24.0V@2.5A, Pin Out: Center Positive (+V), symbol compliant with IEC 60417 symbol no. 5926, Output Configuration: 1200 mm, 16/1C + Shield Cond, UL 1185, Female Barrel 5.5*2.1*11mm w/ Spring Clip & Locking Notch or Equal, Ferrite: Core Size: RH 14.2*28.5*10, GlobTek Black, GT Cord # C4670, Blades/Input Cord: (Order Separately), Approvals:	
	Model No. GTM96600-6024-R2	
	Part No./Ordering No. RR9KI2500CCPCIMR6B	Rev E

Notes/Modifications/Customizations (notes in this section supersede the values shown in the standard spec)
DIMENSIONS ARE IN MM UNLESS SPECIFIED OTHERWISE

GlobTek, Inc. www.globtek.com 186 Veterans Drive, Northvale, NJ 07647 Tel. (201) 784-1000 Fax (201) 784-0111	Drawing Title: GTM96600-6024-R2, ICT / ITE / Medical Power Supply/Class 2/Household Power Supply, Efficiency Level: USA DOE Level VI / Eco-design Directive 2009/125/EC, (EU) 2019/1782, Case Color/Style: GlobTek Black, Wall Plug-in+Desktop Combination, Regulated Switchmode AC-DC Power Supply AC Adaptor, Input Rating: 100-240V~, 50-60 Hz, IEC 60320/C8 w/ Wall Blades Option, , Output Rating: 60.00W, 24.0V@2.5A, Pin Out: Center Positive (+V), symbol compliant with IEC 60417 symbol no. 5926, Output Configuration: 1200 mm, 16/1C + Shield Cond, UL 1185, Female Barrel 5.5*2.1*11mm w/ Spring Clip & Locking Notch or Equal, Ferrite: Core Size: RH 14.2*28.5*10, GlobTek Black, GT Cord # C4670, Blades/Input Cord: (Order Separately), Approvals:	
	Model No. GTM96600-6024-R2	
	Part No./Ordering No. RR9KI2500CCPCIMR6B	Rev E

ELECTRICAL SPECIFICATIONS

Input

Input Voltage:	Specified: 90-264VAC, Nameplate: 100-240VAC 100% rated load current for 90-264VAC 85% rated load current for 85-264VAC 100% rated load current for 110-370VDC
Input Frequency:	Specified: 47-63Hz, Nameplate: 50-60Hz
No Load Input Power:	<75mW @ 230VAC (EU CoC Tier 2 compliant) for ≤ 49W rating <150mW @ 230VAC (EU CoC Tier 2 compliant) for > 49W rating
Inrush Current:	30A/60A max. (cold start @ 115V/230VAC)
Efficiency:	DoE Level VI and EU CoC Tier 2 compliant

Output

Turn-on Delay:	1 second max. @ 115VAC and full load
Output Regulation:	± 5% (measured at output connector)
Line Regulation:	± 0.5% typ. (measured at output connector)
Ripple:	1% or 100mV, whichever is greater (using a 47µF low-ESR cap + 0.1µF ceramic capacitor, measured @ 20MHz BW, at output connector)
Transient Response:	5% max. deviation, 1ms typ. recovery time (with 40% to 70% load step)
Hold-up Time:	8ms typ. (nominal input voltage and full load)
Power Indicator:	Green LED

Protections

Input Protection:	MOV transient suppressor, input line fusing
Over-Current Protection:	110 - 160% of rated output current, auto-restart, current limit range determined by normal output power rating, not de-rated power rating
Short-Circuit Protection:	Auto-restart
Over-Voltage Protection:	110 - 130%, latched off, cycle AC to reset
Over-Temperature Protection:	On-chip temperature sensor (integrated in primary-side switching controller), shut down at Tj = ~140°C, latched off, cycle AC to reset

GlobTek, Inc. www.globtek.com 186 Veterans Drive, Northvale, NJ 07647 Tel. (201) 784-1000 Fax (201) 784-0111	Drawing Title: GTM96600-6024-R2, ICT / ITE / Medical Power Supply/Class 2/Household Power Supply, Efficiency Level: USA DOE Level VI / Eco-design Directive 2009/125/EC, (EU) 2019/1782, Case Color/Style: GlobTek Black, Wall Plug-in+Desktop Combination, Regulated Switchmode AC-DC Power Supply AC Adaptor, Input Rating: 100-240V~, 50-60 Hz, IEC 60320/C8 w/ Wall Blades Option, , Output Rating: 60.00W, 24.0V@2.5A, Pin Out: Center Positive (+V), symbol compliant with IEC 60417 symbol no. 5926, Output Configuration: 1200 mm, 16/1C + Shield Cond, UL 1185, Female Barrel 5.5*2.1*11mm w/ Spring Clip & Locking Notch or Equal, Ferrite: Core Size: RH 14.2*28.5*10, GlobTek Black, GT Cord # C4670, Blades/Input Cord: (Order Separately), Approvals:	
	Model No. GTM96600-6024-R2	
	Part No./Ordering No. RR9KI2500CCPCIMR6B	Rev E

Environmental

MTBF:	1,500,000 hours @ 25°C ambient, full load (Telcordia SR-332, Issue 3)
Operating Temperature:	-20°C to 40°C (full load)
Storage Temperature:	-30°C to 80°C
Humidity:	0% to 95% relative humidity, non-condensing
Altitude:	5000m
Cooling:	Convection
RoHS:	Complies with EU 2011/65/EU and China SJ/T 11363-2006
Note 1:	Regarding operating temperature a. See below de-rating table for output power capability at alternate temperature b. Extended low-end temperature range available as a custom option

Safety

Dielectric Withstand Voltage:	4000VAC or 5656VDC from input to output 3000VAC or 4242VDC from input to earth (Class I models only)
Touch Current:	Class I: 20µA max. Class II: 85µA max. Class II F2: 20µA max.
Earth Leakage Current	Class I: 300µA max. Class II: N/A
Means of Protection:	2 x MOPP
Output Isolation Options:	Class I: C6 or C14 inlet (output negative tied to Earth contact) Class II: C8 or C18 inlet Class II FE: C6 or C14 inlet (output isolated from Earth contact) Review isolation options by reading our white paper PSU Isolation and Identity .
Earth Continuity Test:	< 0.1Ω between earth pin (on AC inlet) and PCB termination point (Class I models only)
Compliant Standards:	See listing at end of this datasheet for specific standards

GlobTek, Inc. www.globtek.com 186 Veterans Drive, Northvale, NJ 07647 Tel. (201) 784-1000 Fax (201) 784-0111	Drawing Title: GTM96600-6024-R2, ICT / ITE / Medical Power Supply/Class 2/Household Power Supply, Efficiency Level: USA DOE Level VI / Eco-design Directive 2009/125/EC, (EU) 2019/1782, Case Color/Style: GlobTek Black, Wall Plug-in+Desktop Combination, Regulated Switchmode AC-DC Power Supply AC Adaptor, Input Rating: 100-240V~, 50-60 Hz, IEC 60320/C8 w/ Wall Blades Option, , Output Rating: 60.00W, 24.0V@2.5A, Pin Out: Center Positive (+V), symbol compliant with IEC 60417 symbol no. 5926, Output Configuration: 1200 mm, 16/1C + Shield Cond, UL 1185, Female Barrel 5.5*2.1*11mm w/ Spring Clip & Locking Notch or Equal, Ferrite: Core Size: RH 14.2*28.5*10, GlobTek Black, GT Cord # C4670, Blades/Input Cord: (Order Separately), Approvals:	
	Model No. GTM96600-6024-R2	
	Part No./Ordering No. RR9KI2500CCPCIMR6B	Rev E

EMC

Applicable Standards:	Medical: EN60601-1-2, 4th edition Emissions: EN55032, EN61000-6-3, EN61000-6-4, CISPR11, CISPR22 Immunity: EN55024, EN61000-6-1, EN61000-6-2
Conducted Emissions:	Class B, FCC Part 15, Class B (with resistive load)
Radiated Emissions:	Class B, FCC Part 15, Class B (with resistive load)
Harmonic Current Voltage Distortion:	EN61000-3-2, Class A
Voltage Fluctuations/Flicker:	EN61000-3-3
Electrostatic Discharge (ESD) Immunity:	EN61000-4-2, 10KV contact discharge, 20KV air discharge
Radiated RF Immunity:	EN61000-4-3, 10V/m 80-1000MHz, 3V/m 1-2.7GHz, 80% 1KHz AM
EFT/Burst Immunity:	EN61000-4-4, 4KV/100kHz.
Line Surge Immunity:	EN61000-4-5, 2KV differential, 4KV common-mode
Conducted RF Immunity:	EN61000-4-6, 3VRMS, 80% 1KHz AM
Power Frequency Magnetic Field Immunity:	EN61000-4-8, 3A/m
Voltage Dip Immunity:	EN61000-4-11

Enclosure

Housing:	High impact plastic, 94V0 polycarbonate, non-vented
AC Input Mechanical Options:	Desktop: C6, C7, C14, or C18 inlet Hybrid: Desktop inlet or changeable blades for wall-plug-in style, Class I or Class II input
Markings:	Label and/or pad printed and/or laser-etched into case

Special Options

1. Removal of LED (cost reduction or aesthetic purpose)
2. Custom cordsets, various cordage types, and connector types
3. Custom markings
4. Short term output surge capability for motors or other high peak current loads. (Available up to 120W for 1 second at nameplate voltage range. Higher levels possible for limited input voltage range, or larger allowed voltage dip.)
5. Reduced leakage current
6. Tightened output voltage tolerance
7. Reduced output ripple level
8. Reduced output power rating
9. High reliability PCB laminate with plated through-holes for IPC610 Class 2 compliance
10. Low temperature option, down to -40°C
11. Special housing and cordset colors
12. "Back EMF" upgrade, for motor loads and other high inductance applications with reverse energy flow requirements
13. Improved ingress protection (IP) rating

<p>GlobTek, Inc. www.globtek.com 186 Veterans Drive, Northvale, NJ 07647 Tel. (201) 784-1000 Fax (201) 784-0111</p>	<p>Drawing Title: GTM96600-6024-R2, ICT / ITE / Medical Power Supply/Class 2/Household Power Supply, Efficiency Level: USA DOE Level VI / Eco-design Directive 2009/125/EC, (EU) 2019/1782, Case Color/Style: GlobTek Black, Wall Plug-in+Desktop Combination, Regulated Switchmode AC-DC Power Supply AC Adaptor, Input Rating: 100-240V~, 50-60 Hz, IEC 60320/C8 w/ Wall Blades Option, , Output Rating: 60.00W, 24.0V@2.5A, Pin Out: Center Positive (+V), symbol compliant with IEC 60417 symbol no. 5926, Output Configuration: 1200 mm, 16/1C + Shield Cond, UL 1185, Female Barrel 5.5*2.1*11mm w/ Spring Clip & Locking Notch or Equal, Ferrite: Core Size: RH 14.2*28.5*10, GlobTek Black, GT Cord # C4670, Blades/Input Cord: (Order Separately), Approvals:</p>
	<p>Model No. GTM96600-6024-R2</p>
	<p>Part No./Ordering No. RR9KI2500CCPCIMR6B Rev E</p>

Output Connectors

- Several output connector options are available with various output current ratings. GlobTek can supply 10A rated 2.1mm and 2.5mm style DC Power Jacks, to complement our 10A output rated 2.1mm and 2.5mm DC power plugs used on our output cordsets.
- Please visit our real-time listing of mating connector product offering:
<https://en.globtek.com/news/high-current-coaxial-barrel-plug-jacks-for-high-wattage-power-supplies>

TO ADDRESS SYSTEM-LEVEL EMI CONCERNS, FERRITE CHOKES/BEADS MAY BE ADDED/REVISED UPON REQUEST. A SAMPLE KIT OF GLOBTEK'S STANDARD FERRITES IS AVAILABLE UNDER GLOBTEK P/N: EMI-MITIGATION-KIT1

FOR ADDITIONAL INFORMATION, PLEASE READ OUR WHITE PAPER AT: <https://r.globtek.info/3QeaqtD>

INGRESS PROTECTION: IP40, IP54 Option available

GlobTek, Inc.
www.globtek.com
186 Veterans Drive,
Northvale, NJ 07647
Tel. (201) 784-1000
Fax (201) 784-0111

Drawing Title: GTM96600-6024-R2, ICT / ITE / Medical Power Supply/Class 2/Household Power Supply, Efficiency Level: USA DOE Level VI / Eco-design Directive 2009/125/EC, (EU) 2019/1782, Case Color/Style: GlobTek Black, Wall Plug-in+Desktop Combination, Regulated Switchmode AC-DC Power Supply AC Adaptor, Input Rating: 100-240V~, 50-60 Hz, IEC 60320/C8 w/ Wall Blades Option, , Output Rating: 60.00W, 24.0V@2.5A, Pin Out: Center Positive (+V), symbol compliant with IEC 60417 symbol no. 5926, Output Configuration: 1200 mm, 16/1C + Shield Cond, UL 1185, Female Barrel 5.5*2.1*11mm w/ Spring Clip & Locking Notch or Equal, Ferrite: Core Size: RH 14.2*28.5*10, GlobTek Black, GT Cord # C4670, Blades/Input Cord: (Order Separately), Approvals:

Model No. GTM96600-6024-R2

Part No./Ordering No. RR9KI2500CCPCIMR6B

Rev E

3D File Download <https://www.globtek.com/dl/GTM96600-R2.igs>

Mechanical drawing

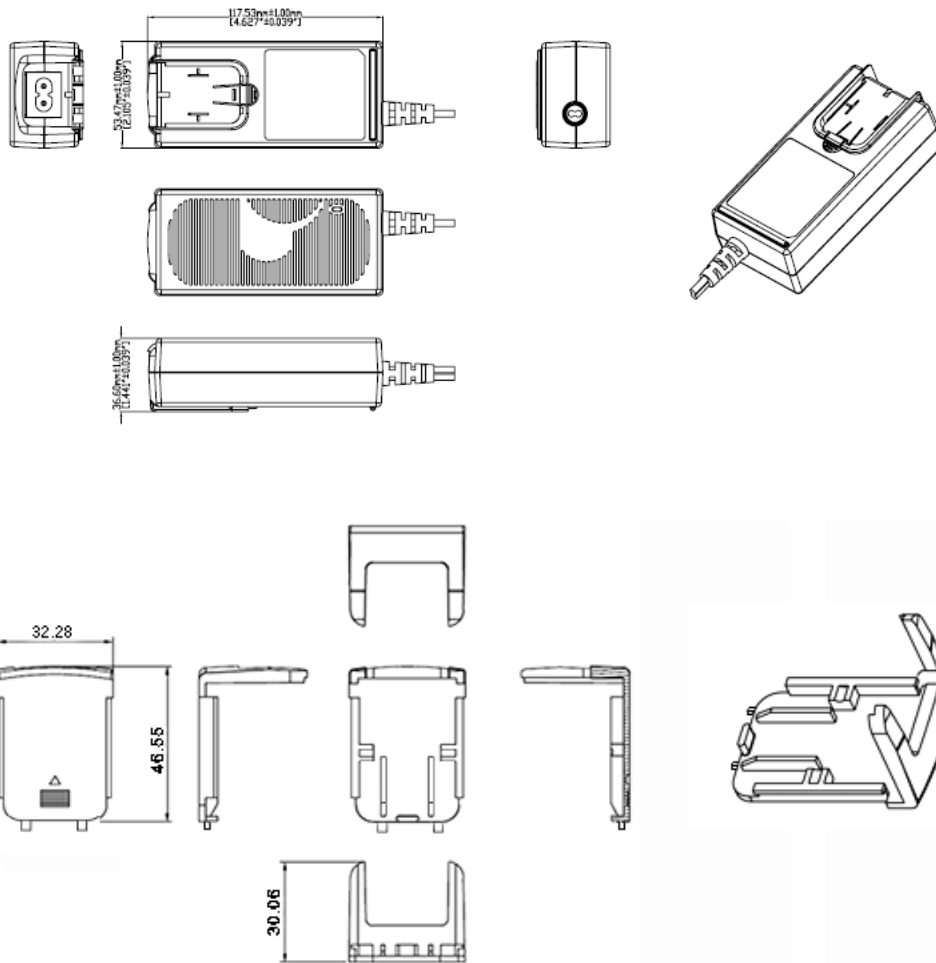

Unit shipped without an installed input plug.
"Desktop insert" installed.

<p>GlobTek, Inc. www.globtek.com 186 Veterans Drive, Northvale, NJ 07647 Tel. (201) 784-1000 Fax (201) 784-0111</p>	<p>Drawing Title: GTM96600-6024-R2, ICT / ITE / Medical Power Supply/Class 2/Household Power Supply, Efficiency Level: USA DOE Level VI / Eco-design Directive 2009/125/EC, (EU) 2019/1782, Case Color/Style: GlobTek Black, Wall Plug-in+Desktop Combination, Regulated Switchmode AC-DC Power Supply AC Adaptor, Input Rating: 100-240V~, 50-60 Hz, IEC 60320/C8 w/ Wall Blades Option, , Output Rating: 60.00W, 24.0V@2.5A, Pin Out: Center Positive (+V), symbol compliant with IEC 60417 symbol no. 5926, Output Configuration: 1200 mm, 16/1C + Shield Cond, UL 1185, Female Barrel 5.5*2.1*11mm w/ Spring Clip & Locking Notch or Equal, Ferrite: Core Size: RH 14.2*28.5*10, GlobTek Black, GT Cord # C4670, Blades/Input Cord: (Order Separately), Approvals:</p> <p>Model No. GTM96600-6024-R2</p> <p>Part No./Ordering No. RR9KI2500CCPCIMR6B</p>	<p>Rev E</p>
--	--	--------------

DERATING CURVE

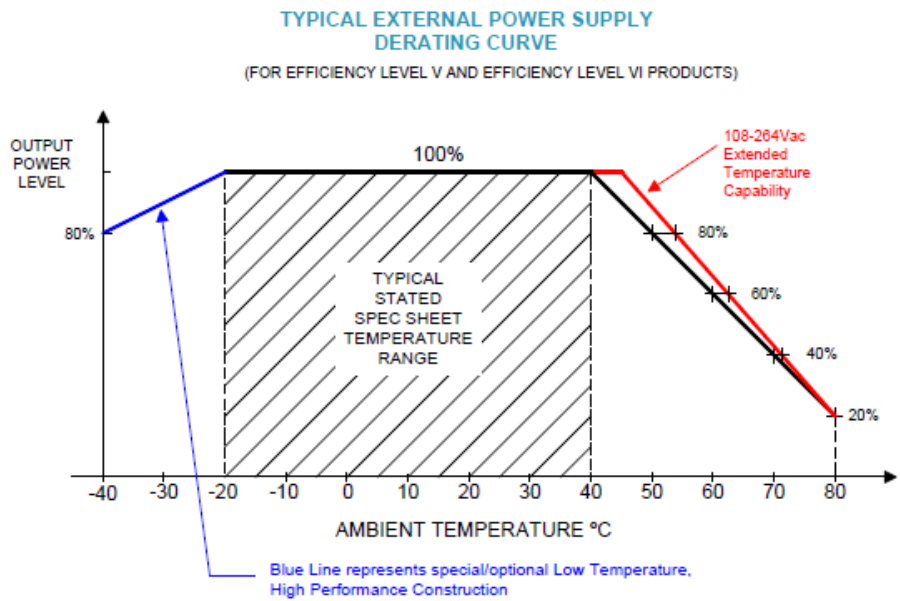

<p>GlobTek, Inc. www.globtek.com 186 Veterans Drive, Northvale, NJ 07647 Tel. (201) 784-1000 Fax (201) 784-0111</p>	<p>Drawing Title: GTM96600-6024-R2, ICT / ITE / Medical Power Supply/Class 2/Household Power Supply, Efficiency Level: USA DOE Level VI / Eco-design Directive 2009/125/EC, (EU) 2019/1782, Case Color/Style: GlobTek Black, Wall Plug-in+Desktop Combination, Regulated Switchmode AC-DC Power Supply AC Adaptor, Input Rating: 100-240V~, 50-60 Hz, IEC 60320/C8 w/ Wall Blades Option, , Output Rating: 60.00W, 24.0V@2.5A, Pin Out: Center Positive (+V), symbol compliant with IEC 60417 symbol no. 5926, Output Configuration: 1200 mm, 16/1C + Shield Cond, UL 1185, Female Barrel 5.5*2.1*11mm w/ Spring Clip & Locking Notch or Equal, Ferrite: Core Size: RH 14.2*28.5*10, GlobTek Black, GT Cord # C4670, Blades/Input Cord: (Order Separately), Approvals:</p>	<p>Model No. GTM96600-6024-R2 Part No./Ordering No. RR9KI2500CCPCIMR6B Rev E</p>
---	--	--

INPUT CONFIGURATION

(F1) Floating output, Class II / double insulated

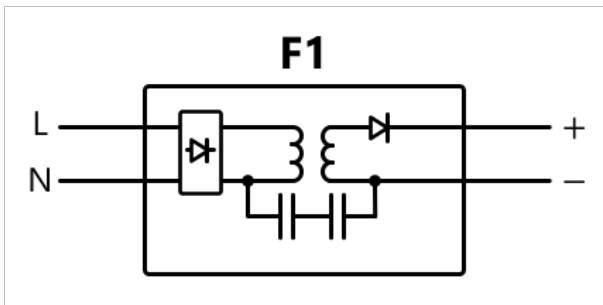

[Alternate grounding configurations](#) available upon request.

Blades/Cord Included:None:(Order Separately)

Blades/Cord Installed:None:(Order Separately)

T2/R2 Inlet R Series (IEC 60320/C8 or Interchangeable)
IEC 60320/C8 AC Inlet connector

[Blade Insertion Instructions](#)

[R-Blade Style Instruction Video](#)

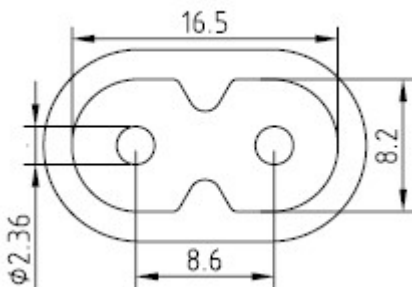

Mates with IEC 60320/C8 Plug

This series of Interchangeable Blade products may be used with Proprietary Interchangeable Blades as described below or with standard international power cords.

Optional INPUT BLADES: R-Socket: below are available blades configurations which are "not included" (unless stated above); may be purchased separately, packaged with power supply, or as a separate "R-KIT" if specified

PROPRIETARY INFORMATION

PROPRIETARY OF GLOBTEK, INC. ANY REPRODUCTION, DISCLOSURE OR USE OF THIS DRAWING, IN WHOLE OR IN PART, IS HEREBY PROHIBITED EXCEPT AS SPECIFIED IN Page 10 of 26

WRITING BY GLOBTEK, INC. © GlobTek, Inc. 2015 - 2024

quest / 12/25/2024 4:24:10 AM GMT

GlobTek, Inc. www.globtek.com 186 Veterans Drive, Northvale, NJ 07647 Tel. (201) 784-1000 Fax (201) 784-0111	Drawing Title: GTM96600-6024-R2, ICT / ITE / Medical Power Supply/Class 2/Household Power Supply, Efficiency Level: USA DOE Level VI / Eco-design Directive 2009/125/EC, (EU) 2019/1782, Case Color/Style: GlobTek Black, Wall Plug-in+Desktop Combination, Regulated Switchmode AC-DC Power Supply AC Adaptor, Input Rating: 100-240V~, 50-60 Hz, IEC 60320/C8 w/ Wall Blades Option, , Output Rating: 60.00W, 24.0V@2.5A, Pin Out: Center Positive (+V), symbol compliant with IEC 60417 symbol no. 5926, Output Configuration: 1200 mm, 16/1C + Shield Cond, UL 1185, Female Barrel 5.5*2.1*11mm w/ Spring Clip & Locking Notch or Equal, Ferrite: Core Size: RH 14.2*28.5*10, GlobTek Black, GT Cord # C4670, Blades/Input Cord: (Order Separately), Approvals:	
	Model No. GTM96600-6024-R2	
	Part No./Ordering No. RR9KI2500CCPCIMR6B	Rev E

# Part Number	Main Country/Region	Plug	IECEE Type
1 R-NA-2(R)	North America, Japan	Nema 1-15P	Type A
2 R-SAA-2(R)	Australia/New Zealand	AS/NZ 3112	Type I
3 R-UK-2(R)	United Kingdom/Ireland	UK, Hong Kong, Singapore, Gulf States	Type G
4 R-EU-2(R)	Europe	CEE 7/16	Type C
5 R-CN-2(R)	China	GB 2099	Type A
6 461-03030003(R)	N/A	R-DI(R) Desktop Insert for use with a cord	N/A
7 R-KIT-2(R)	prepackaged kit	1,2,3,4 above	N/A
8 R-KIT-2-INTL(R)	prepackaged kit	2,3,4 above	N/A

<p>GlobTek, Inc. www.globtek.com 186 Veterans Drive, Northvale, NJ 07647 Tel. (201) 784-1000 Fax (201) 784-0111</p>	<p>Drawing Title: GTM96600-6024-R2, ICT / ITE / Medical Power Supply/Class 2/Household Power Supply, Efficiency Level: USA DOE Level VI / Eco-design Directive 2009/125/EC, (EU) 2019/1782, Case Color/Style: GlobTek Black, Wall Plug-in+Desktop Combination, Regulated Switchmode AC-DC Power Supply AC Adaptor, Input Rating: 100-240V~, 50-60 Hz, IEC 60320/C8 w/ Wall Blades Option, , Output Rating: 60.00W, 24.0V@2.5A, Pin Out: Center Positive (+V), symbol compliant with IEC 60417 symbol no. 5926, Output Configuration: 1200 mm, 16/1C + Shield Cond, UL 1185, Female Barrel 5.5*2.1*11mm w/ Spring Clip & Locking Notch or Equal, Ferrite: Core Size: RH 14.2*28.5*10, GlobTek Black, GT Cord # C4670, Blades/Input Cord: (Order Separately), Approvals:</p>	
	<p>Model No. GTM96600-6024-R2</p>	
	<p>Part No./Ordering No. RR9KI2500CCPCIMR6B</p>	<p>Rev E</p>

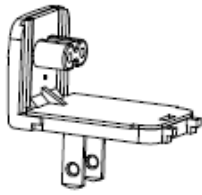

UL 2P

P/N: R-NA-2(R)
NORTH AMERICA
JAPAN

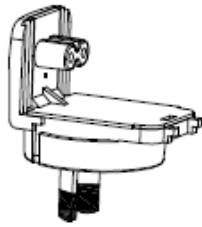

AUS 2P

P/N: R-SAA-2(R)
AUSTRALIA

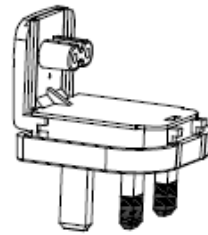

UK 2P

P/N: R-UK-2(R)
UNITED KINGDOM
HONG KONG
SINGAPORE

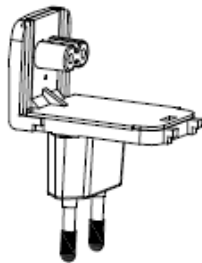

EU 2P

P/N: R-EU-2(R)
EUROPE
SOUTH AMERICA



CN 2P

P/N: R-CN-2(R)
CHINA

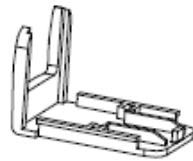

R-DI

P/N: R-DI
DESKTOP INSERT

Standard Cordsets

Below are standard cordsets which are "not included" (unless stated above); these may be purchased separately or packaged with the power supply. Contact your Sales Engineer if the style required is not shown below. Many more available in different lengths, colors or cable material.

[Standard International IEC 320/C7 Cordsets](#)

GlobTek, Inc. www.globtek.com 186 Veterans Drive, Northvale, NJ 07647 Tel. (201) 784-1000 Fax (201) 784-0111	Drawing Title: GTM96600-6024-R2, ICT / ITE / Medical Power Supply/Class 2/Household Power Supply, Efficiency Level: USA DOE Level VI / Eco-design Directive 2009/125/EC, (EU) 2019/1782, Case Color/Style: GlobTek Black, Wall Plug-in+Desktop Combination, Regulated Switchmode AC-DC Power Supply AC Adaptor, Input Rating: 100-240V~, 50-60 Hz, IEC 60320/C8 w/ Wall Blades Option, , Output Rating: 60.00W, 24.0V@2.5A, Pin Out: Center Positive (+V), symbol compliant with IEC 60417 symbol no. 5926, Output Configuration: 1200 mm, 16/1C + Shield Cond, UL 1185, Female Barrel 5.5*2.1*11mm w/ Spring Clip & Locking Notch or Equal, Ferrite: Core Size: RH 14.2*28.5*10, GlobTek Black, GT Cord # C4670, Blades/Input Cord: (Order Separately), Approvals:	
	Model No. GTM96600-6024-R2	
	Part No./Ordering No. RR9KI2500CCPCIMR6B	Rev E

Part Number	Country	Plug	Connector	Length (mm)	Length (feet)
2094112M703(R)	Argentina (Type I)	IRAM 2063	IEC 320/C7	2000	7
5014112M703A(R)	Australian (Type I)	AS 3112	IEC 320/C7	2000	7
207B4111M8703(R)	Brazil (Type N)	NBR14136	IEC 320/C7	1800	6
4533501M8703(R)	China (Type A)	GB 2099.1	IEC 320/C7	1830	6
2074112M703A(R)	European (Type C)	CEE 7/16	IEC 320/C7	2000	7
2084111M8703(R)	South Africa (Type M)	BS 546	IEC 320/C7	1800	6
2084111M8703B(R)	India (Type D)	ISI:1293	IEC 320/C7	1800	6
2714111M8703A(R)	India (Type C)	ISI:1293	IEC 320/C7	1800	6
451J3401M8703(R)	Japan (Type A)	JIS 8303	IEC 320/C7	1830	6
2044112M703A(R)	Korea (Type C)	KS C8305	IEC 320/C7	2000	7
4511116F703A(R)	N. American (Type A)	NEMA 1-15P	IEC 320/C7	1830	6
4033401M8703A(R)	Taiwan (Type A)	CNS690	IEC 320/C7	1830	6
6104112M703A(R)	UK, Hong Kong, Singapore, Gulf States (Type G)	BS1363	IEC 320/C7	2000	7

GlobTek, Inc. www.globtek.com 186 Veterans Drive, Northvale, NJ 07647 Tel. (201) 784-1000 Fax (201) 784-0111	Drawing Title: GTM96600-6024-R2, ICT / ITE / Medical Power Supply/Class 2/Household Power Supply, Efficiency Level: USA DOE Level VI / Eco-design Directive 2009/125/EC, (EU) 2019/1782, Case Color/Style: GlobTek Black, Wall Plug-in+Desktop Combination, Regulated Switchmode AC-DC Power Supply AC Adaptor, Input Rating: 100-240V~, 50-60 Hz, IEC 60320/C8 w/ Wall Blades Option, , Output Rating: 60.00W, 24.0V@2.5A, Pin Out: Center Positive (+V), symbol compliant with IEC 60417 symbol no. 5926, Output Configuration: 1200 mm, 16/1C + Shield Cond, UL 1185, Female Barrel 5.5*2.1*11mm w/ Spring Clip & Locking Notch or Equal, Ferrite: Core Size: RH 14.2*28.5*10, GlobTek Black, GT Cord # C4670, Blades/Input Cord: (Order Separately), Approvals:	
	Model No. GTM96600-6024-R2	
	Part No./Ordering No. RR9KI2500CCPCIMR6B	Rev E

OUTPUT CORD AND CONNECTOR: CL1/C4670

ACTUAL CONNECTORS, OVERMOLDS, FERRITES MAY VARY SLIGHTLY FROM THE PICTURE BELOW

CABLE TYPE	UL 1185
CABLE LENGTH (mm)	1200
CABLE TOLERANCE (mm)	+150, -0
WIRE GAUGE (AWG)	16
CONDUCTORS	1C + Shield
HANK DIMENSION (mm)	80 ± 10
CABLE / CONNECTOR OVERMOLD COLOR	GlobTek Black
FERRITE TYPE AND DIMENSION	Core Size: RH 14.2*28.5*10
FERRITE NUMBER OF TURNS(Definition)	2 Pass thru core (1 turns)
FERRITE DIMENSION FROM STRAIN RELIEF	50±10 mm
FERRITE DIMENSION FROM PLUG	N/A
PLUG TYPE	Female Barrel 5.5*2.1*11mm w/ Spring Clip & Locking Notch or Equal
OVER MOLD ORIENTATION	Straight
CONNECTOR PIN OUT	Center Positive (+V), symbol compliant with IEC 60417 symbol no. 5926
ADDITIONAL REQUIREMENTS	UL1310 Warning Label Up To 36 Volts with plugs

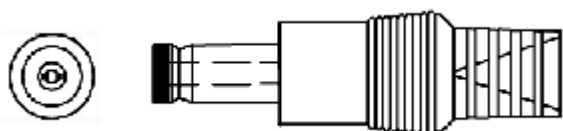

ADDITIONAL OUTPUT PLUG OPTIONS ARE AVAILABLE AT <https://www.globtek.com/en/connectors>
STANDARD PLUGS AND CONNECTORS CAN BE SEEN ONLINE AT <https://www.globtek.com/en/connectors>
CALCULATE VOLTAGE REGULATION/DROP WITH OUR ONLINE CALCULATOR: <https://www.globtek.com/r2/PtqjL>

<p>GlobTek, Inc. www.globtek.com 186 Veterans Drive, Northvale, NJ 07647 Tel. (201) 784-1000 Fax (201) 784-0111</p>	<p>Drawing Title: GTM96600-6024-R2, ICT / ITE / Medical Power Supply/Class 2/Household Power Supply, Efficiency Level: USA DOE Level VI / Eco-design Directive 2009/125/EC, (EU) 2019/1782, Case Color/Style: GlobTek Black, Wall Plug-in+Desktop Combination, Regulated Switchmode AC-DC Power Supply AC Adaptor, Input Rating: 100-240V~, 50-60 Hz, IEC 60320/C8 w/ Wall Blades Option, , Output Rating: 60.00W, 24.0V@2.5A, Pin Out: Center Positive (+V), symbol compliant with IEC 60417 symbol no. 5926, Output Configuration: 1200 mm, 16/1C + Shield Cond, UL 1185, Female Barrel 5.5*2.1*11mm w/ Spring Clip & Locking Notch or Equal, Ferrite: Core Size: RH 14.2*28.5*10, GlobTek Black, GT Cord # C4670, Blades/Input Cord: (Order Separately), Approvals:</p>
	<p>Model No. GTM96600-6024-R2</p>
	<p>Part No./Ordering No. RR9KI2500CCPCIMR6B Rev E</p>

OUTPUT CONNECTOR HOOK UP

TO ADDRESS SYSTEM-LEVEL EMI CONCERNS, FERRITE CHOKES/BEADS MAY BE ADDED/REVISED UPON REQUEST. A SAMPLE KIT OF GLOBTEK'S STANDARD FERRITES IS AVAILABLE UNDER GLOBTEK P/N: EMI-MITIGATION-KIT1

FOR ADDITIONAL INFORMATION, PLEASE READ OUR WHITE PAPER AT:

<https://www.globtek.com/en/technical-articles/ferrite-kit-radiated-emi-suppression-kit-for-globtek-power-supplies-cable-assemblies>

GlobTek, Inc. www.globtek.com 186 Veterans Drive, Northvale, NJ 07647 Tel. (201) 784-1000 Fax (201) 784-0111	Drawing Title: GTM96600-6024-R2, ICT / ITE / Medical Power Supply/Class 2/Household Power Supply, Efficiency Level: USA DOE Level VI / Eco-design Directive 2009/125/EC, (EU) 2019/1782, Case Color/Style: GlobTek Black, Wall Plug-in+Desktop Combination, Regulated Switchmode AC-DC Power Supply AC Adaptor, Input Rating: 100-240V~, 50-60 Hz, IEC 60320/C8 w/ Wall Blades Option, , Output Rating: 60.00W, 24.0V@2.5A, Pin Out: Center Positive (+V), symbol compliant with IEC 60417 symbol no. 5926, Output Configuration: 1200 mm, 16/1C + Shield Cond, UL 1185, Female Barrel 5.5*2.1*11mm w/ Spring Clip & Locking Notch or Equal, Ferrite: Core Size: RH 14.2*28.5*10, GlobTek Black, GT Cord # C4670, Blades/Input Cord: (Order Separately), Approvals:	
	Model No. GTM96600-6024-R2	
	Part No./Ordering No. RR9KI2500CCPCIMR6B	Rev E

LABEL:L-1186

LABEL P/N	Standard GT
MATERIAL	Flat Thermal Transfer, Imprintable, Polyester Label and/or Pad Printed and/or Molded, and/or Laser Engraved in the case
BACKGROUND COLOR	Black if housing is Black, White or Silver if housing is White or Gray.
TEXT COLOR	White or Silver if label is Black Background for Black housing. Black if label is White or Silver background and Housing is White or Gray.
LABEL WIDTH (mm)	44.5
LABEL HEIGHT (mm)	49.5
SPECIAL BARCODE LABEL MATERIAL	No

Below is the minimum information which will appear on the label. NOTE: in the logo area additional/actual positioning of symbols and text is subjected to change as per agency updates/requirements or additional model approvals become available. Regulatory certifications/label markings may be in logo area on the label or molded into the case housing outside the label area. Information will be shown via label and/or pad printed and/or molded and/or laser engraved in the case. * Date code markings at GlobTek option

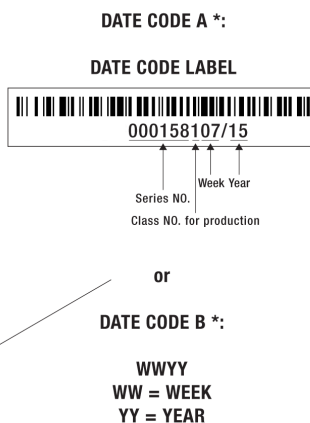

- A=ICT / ITE / Medical Power Supply/Class 2/Household Power Supply
- B=P/N: (料号) RR9KI2500CCPCIMR6B
- C=Model (型号) GTM96600-6024-R2
- D=Input (输入)100-240V~, 50-60 Hz, 1.5 A
- E=Output (输出)24.0 V 2.5 A, 60.00W

GlobTek, Inc. www.globtek.com 186 Veterans Drive, Northvale, NJ 07647 Tel. (201) 784-1000 Fax (201) 784-0111	Drawing Title: GTM96600-6024-R2, ICT / ITE / Medical Power Supply/Class 2/Household Power Supply, Efficiency Level: USA DOE Level VI / Eco-design Directive 2009/125/EC, (EU) 2019/1782, Case Color/Style: GlobTek Black, Wall Plug-in+Desktop Combination, Regulated Switchmode AC-DC Power Supply AC Adaptor, Input Rating: 100-240V~, 50-60 Hz, IEC 60320/C8 w/ Wall Blades Option, , Output Rating: 60.00W, 24.0V@2.5A, Pin Out: Center Positive (+V), symbol compliant with IEC 60417 symbol no. 5926, Output Configuration: 1200 mm, 16/1C + Shield Cond, UL 1185, Female Barrel 5.5*2.1*11mm w/ Spring Clip & Locking Notch or Equal, Ferrite: Core Size: RH 14.2*28.5*10, GlobTek Black, GT Cord # C4670, Blades/Input Cord: (Order Separately), Approvals:	
	Model No. GTM96600-6024-R2	
	Part No./Ordering No. RR9KI2500CCPCIMR6B	Rev E

AGENCY ONLINE DOCUMENTS	http://www.globtek.info/certs/GTM96600-TZ/
CE EC-Declaration for Medical	https://cs.globtek.info/ec_declaration_product?id=01ta0000005xWVs&m=1
CE EC-Declaration for Industrial/Commercial/ITE	https://cs.globtek.info/ec_declaration_product?id=01ta0000005xWVs&i=2
CE EC-Declaration for Household	https://cs.globtek.info/ec_declaration_product?id=01ta0000005xWVs&h=2
UKCA-Declaration for Medical	https://cs.globtek.info/ukca_declaration_product?id=01ta0000005xWVs&m=1
UKCA-Declaration for Industrial/Commercial/ITE	https://cs.globtek.info/ukca_declaration_product?id=01ta0000005xWVs&i=2
UKCA-Declaration for Household	https://cs.globtek.info/ukca_declaration_product?id=01ta0000005xWVs&h=2
Morocco SDoC Declaration	https://cs.globtek.info/Morocco_SDoC_Declaration?id=a0Oa000000MmH0aEAF
RoHS/RoHS3 Declaration	https://www.globtek.com/pdf/rohs_cert/01ta0000005xWVsAAM
REACH Declaration	https://www.globtek.com/pdf/iso_certificates/REACH.pdf
Conflict Minerals Declaration	https://www.globtek.com/pdf/conflict-minerals.pdf
Prop 65 Statement	https://www.globtek.com/prop-65-statement.pdf

IPXY rating is based on 3rd party testing and customers should check suitability and test system level IPXY rating before ordering.

Regulatory Certifications/Label Markings

Below follows a link to the latest regulatory certifications and marks for this specific product. National standards as well as certification schemes are constantly changing and so is the set of certification marks and symbols applicable to this product. Various standards, marks and symbols, and certificates are subject to change at any time without notice.

Additional standards or unique country certifications are available upon request. Please contact Globtek to request a quotation.

LATEST PRODUCT/MODEL CERTIFICATIONS: <https://www.globtek.com/ds/MZnigiinzbw/UpzhHdat2jy.html>

AGENCY ONLINE DOCUMENTS <http://www.globtek.info/certs/GTM96600-TZ/>

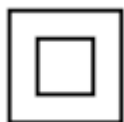

(F1) Floating output, Class II / double insulated

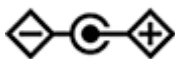

Center Positive (+V), symbol compliant with IEC 60417 symbol no. 5926

GlobTek, Inc. www.globtek.com 186 Veterans Drive, Northvale, NJ 07647 Tel. (201) 784-1000 Fax (201) 784-0111	Drawing Title: GTM96600-6024-R2, ICT / ITE / Medical Power Supply/Class 2/Household Power Supply, Efficiency Level: USA DOE Level VI / Eco-design Directive 2009/125/EC, (EU) 2019/1782, Case Color/Style: GlobTek Black, Wall Plug-in+Desktop Combination, Regulated Switchmode AC-DC Power Supply AC Adaptor, Input Rating: 100-240V~, 50-60 Hz, IEC 60320/C8 w/ Wall Blades Option, , Output Rating: 60.00W, 24.0V@2.5A, Pin Out: Center Positive (+V), symbol compliant with IEC 60417 symbol no. 5926, Output Configuration: 1200 mm, 16/1C + Shield Cond, UL 1185, Female Barrel 5.5*2.1*11mm w/ Spring Clip & Locking Notch or Equal, Ferrite: Core Size: RH 14.2*28.5*10, GlobTek Black, GT Cord # C4670, Blades/Input Cord: (Order Separately), Approvals:	
	Model No. GTM96600-6024-R2	
	Part No./Ordering No. RR9KI2500CCPCIMR6B	Rev E

PACKAGING

Packing Spec P/N	Standard DT, Cellular packaging, User manual
Packing Quantity/Multiple/MPQ	20
Gift Box Size (mm)	N/A
Gift Box Color	None
Master Carton Size (mm)	427 x 405 x 158
Master Carton Cubic Volume (m ³)	0.03
Master GW (Kg)	15.2 kg
BLADES INCLUDED	None: (Order Separately)
BLADE/CORD INSTALLED	None: (Order Separately)
USER MANUAL*	809-DESKTOPUSERMANUAL on A4 paper
USER MANUAL WEB LINK	https://www.globtek.com/pdf/809-DESKTOPUSERMANUAL.jpg

* This specification sheet is considered the user manual for all applications. It is expected that the buyer of this product will use it to formulate their own user manual for their end product and a user manual specifically for the power adapter is not usually required. If a user manual is not specifically listed above then none will be provided with this unit.

If specific packaging is required, this section must specify all requirements and note "no exceptions". If this section does not specify packaging, it is subject to change without notice at GlobTek's discretion.

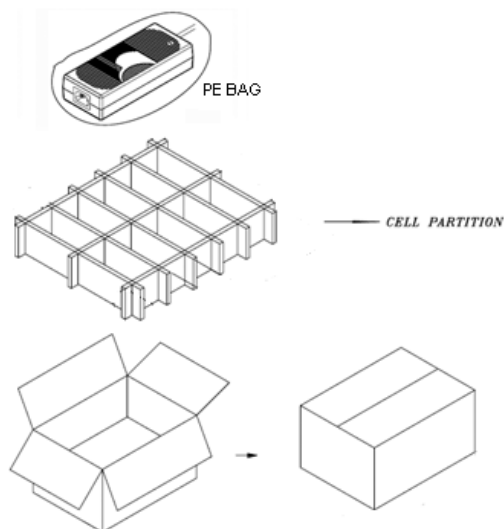

GlobTek, Inc. www.globtek.com 186 Veterans Drive, Northvale, NJ 07647 Tel. (201) 784-1000 Fax (201) 784-0111	Drawing Title: GTM96600-6024-R2, ICT / ITE / Medical Power Supply/Class 2/Household Power Supply, Efficiency Level: USA DOE Level VI / Eco-design Directive 2009/125/EC, (EU) 2019/1782, Case Color/Style: GlobTek Black, Wall Plug-in+Desktop Combination, Regulated Switchmode AC-DC Power Supply AC Adaptor, Input Rating: 100-240V~, 50-60 Hz, IEC 60320/C8 w/ Wall Blades Option, , Output Rating: 60.00W, 24.0V@2.5A, Pin Out: Center Positive (+V), symbol compliant with IEC 60417 symbol no. 5926, Output Configuration: 1200 mm, 16/1C + Shield Cond, UL 1185, Female Barrel 5.5*2.1*11mm w/ Spring Clip & Locking Notch or Equal, Ferrite: Core Size: RH 14.2*28.5*10, GlobTek Black, GT Cord # C4670, Blades/Input Cord: (Order Separately), Approvals:	
	Model No. GTM96600-6024-R2	
	Part No./Ordering No. RR9KI2500CCPCIMR6B	Rev E

INSTRUCTIONS TO THE OEM SYSTEMS ENGINEER

It is the responsibility of the OEM systems engineer to provide the end system user instructions and warnings for the use of this product in the end system.

If an input cord is required for this product, AC Mains voltage should be provided to the power supply by a power supply cord approved to the national standards of the country in which it will be used.

This product is not designed to be repaired. No serviceable parts inside. A blown internal fuse is an indication of catastrophic failure of circuit component(s). If a Failure Analysis is required for a failed power supply/battery charger, please return the damaged unit to GlobTek for an accurate determination of the root cause of the failure.

EMC Compliance of the complete OEM product, including the GlobTek power supply/battery charger needs to be verified by the OEM systems engineer.

GlobTek, Inc. www.globtek.com 186 Veterans Drive, Northvale, NJ 07647 Tel. (201) 784-1000 Fax (201) 784-0111	Drawing Title: GTM96600-6024-R2, ICT / ITE / Medical Power Supply/Class 2/Household Power Supply, Efficiency Level: USA DOE Level VI / Eco-design Directive 2009/125/EC, (EU) 2019/1782, Case Color/Style: GlobTek Black, Wall Plug-in+Desktop Combination, Regulated Switchmode AC-DC Power Supply AC Adaptor, Input Rating: 100-240V~, 50-60 Hz, IEC 60320/C8 w/ Wall Blades Option, , Output Rating: 60.00W, 24.0V@2.5A, Pin Out: Center Positive (+V), symbol compliant with IEC 60417 symbol no. 5926, Output Configuration: 1200 mm, 16/1C + Shield Cond, UL 1185, Female Barrel 5.5*2.1*11mm w/ Spring Clip & Locking Notch or Equal, Ferrite: Core Size: RH 14.2*28.5*10, GlobTek Black, GT Cord # C4670, Blades/Input Cord: (Order Separately), Approvals:	
	Model No. GTM96600-6024-R2	
	Part No./Ordering No. RR9KI2500CCPCIMR6B	Rev E

INSTRUCTION SHEET

N/A

GlobTek, Inc. www.globtek.com 186 Veterans Drive, Northvale, NJ 07647 Tel. (201) 784-1000 Fax (201) 784-0111	Drawing Title: GTM96600-6024-R2, ICT / ITE / Medical Power Supply/Class 2/Household Power Supply, Efficiency Level: USA DOE Level VI / Eco-design Directive 2009/125/EC, (EU) 2019/1782, Case Color/Style: GlobTek Black, Wall Plug-in+Desktop Combination, Regulated Switchmode AC-DC Power Supply AC Adaptor, Input Rating: 100-240V~, 50-60 Hz, IEC 60320/C8 w/ Wall Blades Option, , Output Rating: 60.00W, 24.0V@2.5A, Pin Out: Center Positive (+V), symbol compliant with IEC 60417 symbol no. 5926, Output Configuration: 1200 mm, 16/1C + Shield Cond, UL 1185, Female Barrel 5.5*2.1*11mm w/ Spring Clip & Locking Notch or Equal, Ferrite: Core Size: RH 14.2*28.5*10, GlobTek Black, GT Cord # C4670, Blades/Input Cord: (Order Separately), Approvals:	
	Model No. GTM96600-6024-R2	
	Part No./Ordering No. RR9KI2500CCPCIMR6B	Rev E

TERMS AND CONDITIONS

THESE TERMS AND CONDITIONS GOVERN THE SALE OF ALL PRODUCTS AND SERVICES ("PRODUCTS") BY GlobTek, Inc. ("GlobTek") AND APPLY NOTWITHSTANDING ANY CONFLICTING, CONTRARY OR ADDITIONAL TERMS AND CONDITIONS IN ANY PURCHASE ORDER OR OTHER DOCUMENT OR COMMUNICATION ("PURCHASE ORDER") FROM BUYER. THESE TERMS AND CONDITIONS MAY ONLY BE WAIVED OR MODIFIED IN A WRITTEN AGREEMENT SIGNED BY AN AUTHORIZED REPRESENTATIVE OF THE SELLER. NEITHER SELLER'S ACKNOWLEDGEMENT OF A PURCHASE ORDER NOR SELLER'S FAILURE TO OBJECT TO CONFLICTING, CONTRARY OR ADDITIONAL TERMS AND CONDITIONS IN A PURCHASE ORDER SHALL BE DEEMED AN ACCEPTANCE OF SUCH TERMS AND CONDITIONS OR A WAIVER OF THE PROVISIONS HEREOF.

ORDERS:

1. Buyer must issue a Purchase Order or otherwise place an order by means acceptable to GlobTek. Orders shall identify the Products, unit quantities, part numbers, descriptions, applicable prices, ship to address and requested delivery dates. All orders are subject to acceptance by GlobTek. No order may be cancelled or rescheduled without GlobTek's consent. Consent may be given by GlobTek in its sole discretion. GlobTek reserves the right to add a Rescheduling Fee should Seller deem applicable. Seller reserves the right to allocate sales of Products among its customers in its sole discretion.

RESTOCKING TERMS:

1. Returning of stock items only: All claims must be made within ten (10) days of receipt of goods. GlobTek must authorize all returns. No return of product will be accepted without GlobTek's Return Merchandise Authorization (RMA) number. All authorized returns will be subject to a minimum of 25% restocking charge* and buyer must pay return freight to GlobTek. Parts must be in original condition and packaging.
2. *Custom items and/or dedicated production lots are not returnable.

<p>GlobTek, Inc. www.globtek.com 186 Veterans Drive, Northvale, NJ 07647 Tel. (201) 784-1000 Fax (201) 784-0111</p>	<p>Drawing Title: GTM96600-6024-R2, ICT / ITE / Medical Power Supply/Class 2/Household Power Supply, Efficiency Level: USA DOE Level VI / Eco-design Directive 2009/125/EC, (EU) 2019/1782, Case Color/Style: GlobTek Black, Wall Plug-in+Desktop Combination, Regulated Switchmode AC-DC Power Supply AC Adaptor, Input Rating: 100-240V~, 50-60 Hz, IEC 60320/C8 w/ Wall Blades Option, , Output Rating: 60.00W, 24.0V@2.5A, Pin Out: Center Positive (+V), symbol compliant with IEC 60417 symbol no. 5926, Output Configuration: 1200 mm, 16/1C + Shield Cond, UL 1185, Female Barrel 5.5*2.1*11mm w/ Spring Clip & Locking Notch or Equal, Ferrite: Core Size: RH 14.2*28.5*10, GlobTek Black, GT Cord # C4670, Blades/Input Cord: (Order Separately), Approvals:</p>
	<p>Model No. GTM96600-6024-R2</p>
	<p>Part No./Ordering No. RR9KI2500CCPCIMR6B Rev E</p>

RETURNED MERCHANDISE:

1. Replacement or credit will not be allowed for products returned without prior consent. No return of product will be accepted without a GlobTek RMA number. RMA requests for all goods that are found to be not in compliance with Seller's specifications shall be made according to Seller's RMA procedure within thirty (30) days of invoice/shipment date and may be replaced, repaired, or credited at GlobTek's option. All RMA claims reported more than thirty (30) days after the invoice/shipment date are not eligible for return, replacement or credit at subject to GlobTek's Terms and Conditions. GlobTek will not issue credit if the Product has been altered, repaired, or opened by persons other than those authorized by GlobTek, become defective due to acts of God or negligence, become defective due to being subjected to abnormal conditions during installation, application or maintenance or if warranty has expired. Acceptance of Buyer's debit will not be made until material has been received and evaluated by the GlobTek. To determine the "Root Cause of Failure", the product may be destroyed during evaluation. If this occurs all of the above Terms and Conditions will remain in effect. All freight costs for returns, both from customer back to GlobTek and GlobTek back to customer will not be borne by GlobTek. GlobTek requires all goods to be returned freight, duty, and taxes prepaid to the location provided in the RMA authorization notification and repaired or replaced goods will be provided on an EX WORKS return location. GlobTek shall not be responsible, under any circumstances, for any rework or modification fee's or costs not previously authorized in writing by GlobTek. If returned goods do not match the quantity or descriptions provided in the RMA application, any non conforming goods will not be qualified for repair, return, or replacement. Goods with illegible date code/serial # information may not be eligible for repair, return, replacement

PRICES/TAXES/TARIFFS:

1. Prices shall be as specified by Seller and shall be applicable for the period specified in GlobTek's quote. If no period is specified, prices shall be applicable for thirty (30) days. Notwithstanding the foregoing, prices shall be subject to increase in the event of an increase in GlobTek's costs or other circumstances beyond GlobTek's reasonable control. Prices are exclusive of taxes, impositions, tariffs, fees, and other charges, including, without limitation, sales, use, excise, value added, and ad valorem taxes, as well as tariffs of all types (including any tariffs imposed pursuant to any Section 301 Action by the United States Trade Representative) and similar taxes, fees, imposts, or charges of whatsoever kind, imposed now or in the future by any foreign or domestic governmental authority, international shipping charges, forwarding agent's and broker's fees, consular fees, document fees and import duties. If GlobTek shall be liable to collect and/or pay, or if the GlobTek shall pay, any of the foregoing, Buyer shall pay same to GlobTek in addition to the price of the Products.

GlobTek, Inc. www.globtek.com 186 Veterans Drive, Northvale, NJ 07647 Tel. (201) 784-1000 Fax (201) 784-0111	Drawing Title: GTM96600-6024-R2, ICT / ITE / Medical Power Supply/Class 2/Household Power Supply, Efficiency Level: USA DOE Level VI / Eco-design Directive 2009/125/EC, (EU) 2019/1782, Case Color/Style: GlobTek Black, Wall Plug-in+Desktop Combination, Regulated Switchmode AC-DC Power Supply AC Adaptor, Input Rating: 100-240V~, 50-60 Hz, IEC 60320/C8 w/ Wall Blades Option, , Output Rating: 60.00W, 24.0V@2.5A, Pin Out: Center Positive (+V), symbol compliant with IEC 60417 symbol no. 5926, Output Configuration: 1200 mm, 16/1C + Shield Cond, UL 1185, Female Barrel 5.5*2.1*11mm w/ Spring Clip & Locking Notch or Equal, Ferrite: Core Size: RH 14.2*28.5*10, GlobTek Black, GT Cord # C4670, Blades/Input Cord: (Order Separately), Approvals:	
	Model No. GTM96600-6024-R2	
	Part No./Ordering No. RR9KI2500CCPCIMR6B	Rev E

TERMS OF PAYMENT:

1. Payment shall be net thirty (30) days from date of invoice or as otherwise specified by GlobTek. Buyer agrees to pay the entire net amount of each invoice from Seller pursuant to the terms of each such invoice without offset or deduction. Orders are subject to credit approval by GlobTek, which may in its sole discretion at any time change the terms of Buyer's credit, require payment in cash, bank wire transfer, or by official bank check and/or require payment of any or all amounts due or to become due for Buyer's order before shipment of any or any of the Products. If GlobTek believes in good faith that Buyer's ability to make payments may be impaired or if Buyer shall fail to pay any invoice when due, GlobTek may suspend delivery of any order or any remaining balance thereof until such payment is made or cancel any order or any remaining balance thereof, and Buyer shall remain liable to pay for any Products already shipped and all Products ordered by Buyer. Buyer agrees to submit such financial information from time to time as may be reasonably requested by GlobTek for the establishment and/or continuation of credit terms. Checks are accepted subject to collection and the date of collection shall be deemed the date of payment. Any check received from Buyer may be applied by GlobTek against any obligation owing from Buyer to GlobTek, regardless of any statement appearing on or referring to such check, without discharging Buyer's liability for any additional amounts owing from Buyer to GlobTek, and the acceptance by GlobTek of such check shall not constitute a waiver of GlobTek's right to pursue the collection of any remaining balance. Buyer shall pay interest on any invoice not paid when due according to the due date at the rate of eighteen (18%) percent annually or the highest rate allowable by law. If Buyer fails to make payment when due, GlobTek may pursue any legal or equitable remedies, in which event GlobTek shall be entitled to reimbursement for costs of collection and reasonable attorneys fees.

REFUSED OR DAMAGED SHIPMENTS:

1. All products returned to GlobTek due to refusal of acceptance by buyer, without GlobTek authorization, will be subject to minimum of 25% restocking charge* and buyer must pay return freight to GlobTek. Parts must be in original condition and packaging. Seller takes extra precautions to insure that shipments are made under the Highest Quality Standards. In the event a shipment is received in damaged condition, Buyer shall contact the carrier to submit claim, keep Products in original boxes pending carrier's inspection and place a replacement order with the Seller.
2. *Custom items and/or dedicated production lots are not returnable.

TECHNICAL ADVICE AND DATA:

1. Any technical advice offered or given in connection with the use of any goods is an accommodation to Buyer without charge and GlobTek shall have no responsibility or liability whatsoever for the content or use of such advice. Without GlobTek's prior written consent, Buyer shall not use, duplicate or disclose any technical data delivered or disclosed by GlobTek to Buyer for any purposes other than for installation, operation or maintenance of goods purchased by Buyer. Any use made of GlobTek classifications, whether it be ECCNs or any variation of Harmonized Tariff codes, is without recourse to GlobTek and at the user's risk. Export classifications are subject to change. If you export or re-export, your company, as the exporter of record, is responsible for determining the correct classification of any item at the time of export. Any export classification by GlobTek is for GlobTek's internal use only and shall not be construed as a representation or warranty regarding the proper export classification nor relied upon to make licensing determinations.

<p>GlobTek, Inc. www.globtek.com 186 Veterans Drive, Northvale, NJ 07647 Tel. (201) 784-1000 Fax (201) 784-0111</p>	<p>Drawing Title: GTM96600-6024-R2, ICT / ITE / Medical Power Supply/Class 2/Household Power Supply, Efficiency Level: USA DOE Level VI / Eco-design Directive 2009/125/EC, (EU) 2019/1782, Case Color/Style: GlobTek Black, Wall Plug-in+Desktop Combination, Regulated Switchmode AC-DC Power Supply AC Adaptor, Input Rating: 100-240V~, 50-60 Hz, IEC 60320/C8 w/ Wall Blades Option, , Output Rating: 60.00W, 24.0V@2.5A, Pin Out: Center Positive (+V), symbol compliant with IEC 60417 symbol no. 5926, Output Configuration: 1200 mm, 16/1C + Shield Cond, UL 1185, Female Barrel 5.5*2.1*11mm w/ Spring Clip & Locking Notch or Equal, Ferrite: Core Size: RH 14.2*28.5*10, GlobTek Black, GT Cord # C4670, Blades/Input Cord: (Order Separately), Approvals:</p>
	<p>Model No. GTM96600-6024-R2</p>
	<p>Part No./Ordering No. RR9KI2500CCPCIMR6B Rev E</p>

FORCE MAJEURE:

- GlobTek shall not be liable for failure to fulfill the obligations herein or for delays in delivery due to causes beyond its reasonable control, including, but not limited to, acts of God, natural disasters, acts or omissions of other parties acts or omissions of civil or military authority, Government priorities, changes in law, material shortages, fire, strikes, floods, epidemics, quarantine restrictions, riots, war, acts of terrorism, delays in transportation or inability to obtain labor or materials through its regular sources. GlobTek's time for performance of any such obligation shall be extended for the time period of such delay or GlobTek may, at its option cancel any order or remaining part thereof without liability, advising in writing notice of such cancellation to Buyer.

LIMITATION OF LIABILITIES:

- BUYER SHALL NOT IN ANY EVENT BE ENTITLED TO, AND SELLER SHALL NOT BE LIABLE FOR INDIRECT, SPECIAL, INCIDENTAL OR CONSEQUENTIAL DAMAGES OF ANY NATURE INCLUDING, WITHOUT LIMITATION BUSINESS INTERRUPTION COSTS, REMOVAL AND/OR REINSTALLATION COSTS, REPROCUREMENT COSTS, LOSS OF PROFIT OR REVENUE, LOSS OF DATA, PROMOTIONAL OR MANUFACTURING EXPENSES, OVERHEAD, INJURY TO REPUTATION OR LOSS OF CUSTOMERS, EVEN IF GLOBTEK HAS BEEN ADVISED OF THE POSSIBILITY OF SUCH DAMAGES. BUYER'S RECOVERY FROM SELLER FOR ANY CLAIM SHALL NOT EXCEED BUYER'S PURCHASE PRICE FOR THE PRODUCT GIVING RISE SUCH CLAIM IRRESPECTIVE OF THE NATURE OF THE CLAIM, WHETHER IN CONTRACT, TORT, WARRANTY OR OTHERWISE. GLOBTEK SHALL NOT BE LIABLE FOR AND BUYER SHALL INDEMNIFY, DEFEND AND HOLD GLOBTEK HARMLESS FROM ANY CLAIMS BASED ON GLOBTEK'S COMPLIANCE WITH BUYER'S DESIGNS, SPECIFICATIONS OR INSTRUCTIONS, OR MODIFICATION OF ANY PRODUCTS BY PARTIES OTHER THAN SELLER, OR USE IN COMBINATION WITH OTHER PRODUCTS. GLOBTEK INC. WILL NOT BE LIABLE FOR THE SAFETY AND PERFORMANCE OF THESE PRODUCTS IF UNAUTHORIZED USE, ACCESS AND/OR REPAIR. END USER SHOULD CONSULT APPLICABLE UL, CSA OR EN STANDARDS FOR PROPER INSTALLATION INSTRUCTIONS. GLOBTEK PRODUCTS ARE NOT AUTHORIZED FOR USE AS MISSION CRITICAL COMPONENTS IN LIFE SUPPORT, HAZARDOUS ENVIRONMENT, NUCLEAR OR AIRCRAFT APPLICATIONS WITHOUT PRIOR WRITTEN APPROVAL FROM THE CEO OF GLOBTEK INC. CONTENTS OF GLOBTEK SPECIFICATIONS ARE SUBJECT TO CHANGE WITHOUT PRIOR NOTICE.

<p>GlobTek, Inc. www.globtek.com 186 Veterans Drive, Northvale, NJ 07647 Tel. (201) 784-1000 Fax (201) 784-0111</p>	<p>Drawing Title: GTM96600-6024-R2, ICT / ITE / Medical Power Supply/Class 2/Household Power Supply, Efficiency Level: USA DOE Level VI / Eco-design Directive 2009/125/EC, (EU) 2019/1782, Case Color/Style: GlobTek Black, Wall Plug-in+Desktop Combination, Regulated Switchmode AC-DC Power Supply AC Adaptor, Input Rating: 100-240V~, 50-60 Hz, IEC 60320/C8 w/ Wall Blades Option, , Output Rating: 60.00W, 24.0V@2.5A, Pin Out: Center Positive (+V), symbol compliant with IEC 60417 symbol no. 5926, Output Configuration: 1200 mm, 16/1C + Shield Cond, UL 1185, Female Barrel 5.5*2.1*11mm w/ Spring Clip & Locking Notch or Equal, Ferrite: Core Size: RH 14.2*28.5*10, GlobTek Black, GT Cord # C4670, Blades/Input Cord: (Order Separately), Approvals:</p>
	<p>Model No. GTM96600-6024-R2</p>
	<p>Part No./Ordering No. RR9KI2500CCPCIMR6B Rev E</p>

GENERAL:

- As used herein, terms appearing in the singular shall include the plural and terms appearing in the plural shall include singular. No rights, duties, agreements or obligations hereunder may be assigned or transferred by either party, by operation of law, merger or otherwise, without the prior written consent of the other. Any attempted or purported assignment shall be void. Notwithstanding the foregoing, GlobTek's obligations under these Terms and Conditions may be performed by divisions, subsidiaries or affiliates of GlobTek. The obligations, rights, terms and conditions hereof shall be binding on the parties hereto and their respective successors and assigns. The waiver of any provision hereof or of any breach or default hereunder shall not be deemed a waiver of any other provision hereof or breach or default hereunder. Any provision hereof which is prohibited or unenforceable in any jurisdiction shall, as to such jurisdiction, be ineffective to the extent of such prohibition or unenforceability without invalidating the remaining provisions hereof in that jurisdiction or affecting the validity or enforceability of such provision in any other jurisdiction. These Terms and Conditions shall be governed by and construed in accordance with the laws of the State of New Jersey, United States, excluding any law or principle, which would apply the law of any other jurisdiction. The United Nations Convention on contracts for the International Sale of Goods shall not apply to these Terms.

LIMITED WARRANTIES:

<p>GlobTek, Inc. www.globtek.com 186 Veterans Drive, Northvale, NJ 07647 Tel. (201) 784-1000 Fax (201) 784-0111</p>	<p>Drawing Title: GTM96600-6024-R2, ICT / ITE / Medical Power Supply/Class 2/Household Power Supply, Efficiency Level: USA DOE Level VI / Eco-design Directive 2009/125/EC, (EU) 2019/1782, Case Color/Style: GlobTek Black, Wall Plug-in+Desktop Combination, Regulated Switchmode AC-DC Power Supply AC Adaptor, Input Rating: 100-240V~, 50-60 Hz, IEC 60320/C8 w/ Wall Blades Option, , Output Rating: 60.00W, 24.0V@2.5A, Pin Out: Center Positive (+V), symbol compliant with IEC 60417 symbol no. 5926, Output Configuration: 1200 mm, 16/1C + Shield Cond, UL 1185, Female Barrel 5.5*2.1*11mm w/ Spring Clip & Locking Notch or Equal, Ferrite: Core Size: RH 14.2*28.5*10, GlobTek Black, GT Cord # C4670, Blades/Input Cord: (Order Separately), Approvals:</p>
	<p>Model No. GTM96600-6024-R2</p>
	<p>Part No./Ordering No. RR9KI2500CCPCIMR6B Rev E</p>

1. GLOBTEK'S POWER SUPPLIES ARE BUILT WITH PRIDE BY PROFESSIONALS DEDICATED TO UNCOMPROMISING QUALITY AND RELIABILITY. YOUR COMPLETE SATISFACTION WITH OUR PRODUCTS IS OUR PARAMOUNT OBJECTIVE. IF GLOBTEK IS GIVEN NOTICE OF A DEFECT IN MATERIALS OR WORKMANSHIP OCCURRING WITHIN FIVE (5) YEARS FROM THE DATE OF SHIPMENT BY GLOBTEK, THEN GLOBTEK SHALL, AT ITS SOLE OPTION: 1) REPAIR OR REPLACE THE DEFECTIVE PART(S) OR PRODUCT(S) OR 2) REFUND THE ORIGINAL PURCHASE PRICE, BOTH SUBJECT TO THE FOLLOWING PROVISIONS OF THIS PARAGRAPH. THIS WARRANTY ONLY EXTENDS TO POWER SUPPLIES, ELECTRICAL ASSEMBLIES AND POWER CABLES MADE BY GLOBTEK. THIS WARRANTY DOES NOT EXTEND TO ANY AND ALL BATTERY CELLS, OR TO BRANDED CONNECTOR ITEMS, CUSTOMER SPECIFIED ITEMS FROM OTHER MANUFACTURERS, CUSTOMER SUPPLIED MATERIALS, OR DEFECTS RESULTING FROM CUSTOMER SUPPLIED MATERIALS. DEFECTS RESULTING FROM CUSTOMER SUPPLIED MATERIALS WILL NULLIFY THIS WARRANTY. THIS WARRANTY ALSO DOES NOT EXTEND TO PRODUCTS WHICH HAVE BEEN OPENED, ALTERED OR REPAIRED BY PERSONS OTHER THAN PERSONS AUTHORIZED BY THE MANUFACTURER OR TO PRODUCTS WHICH BECOME DEFECTIVE DUE TO ACTS OF GOD AND OTHER ACTS CONSTITUTING FORCE MAJEURE AS DEFINED IN SECTION 8 ABOVE, NEGLIGENCE OR THE FAILURE OF THE USER TO FULLY FOLLOW INSTRUCTIONS WITH RESPECT TO INSTALLATION, APPLICATION OR MAINTENANCE. THIS WARRANTY DOES NOT EXTEND TO PRODUCTS WHICH HAVE BEEN SUBJECT TO ABNORMAL USE, ABNORMAL CONDITIONS, IMPROPER STORAGE, SPILLAGE OF LIQUIDS, MISUSE, NEGLIGENCE, EXPOSURE TO CLEANING AGENTS NOT RECOMMENDED BY THE MANUFACTURER, OR OTHER ACTS WHICH ARE NOT THE FAULT OF GLOBTEK. THIS WARRANTY DOES NOT COVER ORDINARY WEAR AND TEAR, DEFECTS IN APPEARANCE, COSMETIC, DECORATIVE OR STRUCTURAL ITEMS OR NON-OPERATIVE PARTS. WITH REGARD TO BATTERY CELLS, OR TO BRANDED CONNECTOR ITEMS, CUSTOMER SPECIFIED ITEMS FROM OTHER MANUFACTURERS, AND CUSTOMER SUPPLIED MATERIALS, THE BUYER IS REFERRED TO THE MANUFACTURER'S WARRANTY, IF ANY. FOR RECHARGEABLE BATTERY PACK PRODUCTS, ANY CLAIM FOR WARRANTY MUST BE SUPPORTED BY AUDITABLE EVIDENCE OF PROPER USE, HANDLING, AND MAINTENANCE ACCORDING TO GLOBTEK AND CELL MANUFACTURER SPECIFICATIONS. THIS WARRANTY IS NOT A WARRANTY OF FUTURE PERFORMANCE. IN ORDER TO EXERCISE THE BUYER'S REMEDY FOR BREACH OF THIS LIMITED WARRANTY, GLOBTEK MUST BE GIVEN WRITTEN NOTICE OF A DEFECT IN MATERIALS OR WORKMANSHIP WITHIN FIVE (5) YEARS OF THE DATE OF SHIPMENT. FURTHER, GLOBTEK'S INSPECTION ESTABLISHES THE EXISTENCE OF A DEFECT. PACKAGING, FREIGHT, INSURANCE AND OTHER CHARGES INCURRED IN RETURNING THE DEFECTIVE PRODUCTS TO WILL BE PAID BY THE BUYER. IF THE BUYER FAILS TO FULLY COMPLY WITH THE FOREGOING, BUYER SHALL NOT BE ENTITLED TO ANY ALLOWANCE OR CLAIM WITH RESPECT TO SUCH PRODUCT. THE BUYER AGREES THAT NO OTHER REMEDY (INCLUDING, BUT NOT LIMITED TO, INCIDENTAL OR CONSEQUENTIAL DAMAGES FOR LOST PROFITS, LOST SALES, INJURY TO PERSON OR PROPERTY OR ANY OTHER INCIDENTAL OR CONSEQUENTIAL LOSSES) SHALL BE AVAILABLE TO THE BUYER.

2. EXCEPT FOR THE FOREGOING EXPRESS LIMITED WARRANTY, GLOBTEK MAKES NO WARRANTY, EXPRESS OR IMPLIED, INCLUDING, BUT NOT LIMITED TO, THE WARRANTIES OF MERCHANTABILITY AND FITNESS FOR A PARTICULAR PURPOSE, ALL OF WHICH IMPLIED WARRANTIES ARE HEREBY SPECIFICALLY DISCLAIMED.