

GlobTek, Inc. www.globtek.com 186 Veterans Drive, Northvale, NJ 07647 Tel. (201) 784-1000 Fax (201) 784-0111	Drawing Title: GT-46401-3612, ICT/ITE Power Supply, Efficiency Level: USA DOE Level VI / Eco-design Directive 2009/125/EC, (EU) 2019/1782, Case Color/Style: GlobTek Black, Wall Plug-in, Regulated Switchmode AC-DC Power Supply AC Adaptor, Input Rating: 100-240V~, 50-60 Hz, Interchangeable Blades, https://www.globtek.com/interchangeable-blades.php , Output Rating: 36.00W, 12.0V@3.0A, Pin Out: Center Positive (+V), symbol compliant with IEC 60417 symbol no. 5926, Output Configuration: 1330 mm, 16/2 Cond, UL 2468, Female Barrel 5.5 * 2.5 * 11mm with internal Spring Clip and Locking Notch or Equal, Ferrite: Core Size: 14.2*28.5*8.2, GlobTek Black, GT Cord # C17701, Blades/Input Cord: (Order Separately), Approvals:	
	Model No. GT-46401-3612	
	Part No./Ordering No. WR9QE3000LCP-N(R6B)	Rev F

In Addition to GlobTek Inc.'s renewed ISO9001:2015 - Quality Management System Certification, GlobTek Inc. is now certified to:

ISO13485:2016 - Medical Devices Quality Management System Certification
ISO14001:2015 - Environmental Management System Certification

ISO Certificates are available online at <https://www.globtek.com/iso-certificates/>

The acceptance of this specification and use of the product described in this document indicates the acceptance and binding of the customer to Globtek TERMS AND CONDITIONS (attached to the end of this document), which supersede all other agreements, terms, and conditions (<https://www.globtek.com/terms-and-conditions/>).

The purchaser of this product (Customer) agrees that it is their sole responsibility to determine suitability/fitness of the product described in this specification for their application and to take precautions for protection against any hazards attendant to the handling and use of the product.

Footnote:

GlobTek Inc. will not be liable for the safety and performance of these power supplies/battery packs if unauthorized access and repair occurs. End user should consult applicable UL, CSA or EN standards for proper installation instruction.

Limitation of Use:

GlobTek products are intended for use with commercial, medical, and/or industrial equipment only. GlobTek product are not authorized for use as mission critical components in life support hazardous environment, nuclear or aircraft applications without prior written approval from the CEO of GlobTek Inc.

Contents of this document are subject to change without prior notice.

Customer Approval of Specification:

Please approve, sign and send back to GlobTek so we can complete order processing.
A delay in receipt of this form will delay delivery schedule.

Company Name: _____	Customer P/N: _____
Quote Number: _____	Date: _____
Authorized Representative Name: _____	Authorized Representative Signature: _____

GlobTek, Inc. www.globtek.com 186 Veterans Drive, Northvale, NJ 07647 Tel. (201) 784-1000 Fax (201) 784-0111	Drawing Title: GT-46401-3612, ICT/ITE Power Supply, Efficiency Level: USA DOE Level VI / Eco-design Directive 2009/125/EC, (EU) 2019/1782, Case Color/Style: GlobTek Black, Wall Plug-in, Regulated Switchmode AC-DC Power Supply AC Adaptor, Input Rating: 100-240V~, 50-60 Hz, Interchangeable Blades, https://www.globtek.com/interchangeable-blades.php, Output Rating: 36.00W, 12.0V@3.0A, Pin Out: Center Positive (+V), symbol compliant with IEC 60417 symbol no. 5926, Output Configuration: 1330 mm, 16/2 Cond, UL 2468, Female Barrel 5.5 * 2.5 * 11mm with internal Spring Clip and Locking Notch or Equal, Ferrite: Core Size: 14.2*28.5*8.2, GlobTek Black, GT Cord # C17701, Blades/Input Cord: (Order Separately), Approvals:	
	Model No. GT-46401-3612	
	Part No./Ordering No. WR9QE3000LCP-N(R6B)	Rev F

REVISION HISTORY

REV	DESCRIPTION	SUB	DATE	APPROVED
F	Update CCC, add EAC, update cable to 1330 +/-100 mm	QA	10/22/2018	QA
E	Update O/P cord from 0 turn to 1 turn	QA	03/14/2018	QA
D1	Add NOM-ETL and FCC markings to the label artwork.	bsiep	10/13/2017	QA
D	Add CCC, UL/CUL, NOM, and RCM approvals	bsiep	08/10/2016	QA
C	Add S-mark to approvals	QA	04/07/2016	QA
B	Update packing.	QA	01/15/2016	QA
A	Initial Release	GTde1	10/22/2015	QA

POWER SUPPLY INFORMATION

TYPE	Wall Plug-in
TECHNOLOGY	Regulated Switchmode AC-DC Power Supply AC Adaptor
CASE COLOR	GlobTek Black
NAMEPLATE RATED INPUT	100-240V~, 50-60 Hz, 1.0A
INPUT CONFIG	Interchangeable Blades
WATTS	36.00
VOLTS OUT	12.0
CURRENT OUT (Amps)	3.0
BLADE/CORD INCLUDED	None (Order Separately)
BLADE/CORD INSTALLED	None :(Order Separately)
INGRESS PROTECTION	Indoor Use
GROUNDING CONFIGURATION	(F1) Floating output, Class II / double insulated
EFFICIENCY LEVEL	USA DOE Level VI / Eco-design Directive 2009/125/EC, (EU) 2019/1782 - Europe Code of Conduct on Energy Efficiency of External Power Supplies - Version 5
OUTPUT CONFIGURATION	1330 mm, 16/2 Cond, UL 2468, Female Barrel 5.5 * 2.5 * 11mm with internal Spring Clip and Locking Notch or Equal, Ferrite: Core Size: 14.2*28.5*8.2, GlobTek Black, GT Cord # C17701
OVERMOLDED	Yes
CONNECTOR PIN OUT	Center Positive (+V), symbol compliant with IEC 60417 symbol no. 5926
LABEL SPECS	Standard GT,L-1186
SPECIAL BARCODE LABEL MATERIAL	No
PACK SPEC	Standard WPI for GT-46401, user manual
USER MANUAL	809-PSUQKITUSERMANUAL on A4 paper

PROPRIETARY INFORMATION

<p>GlobTek, Inc. www.globtek.com 186 Veterans Drive, Northvale, NJ 07647 Tel. (201) 784-1000 Fax (201) 784-0111</p>	<p>Drawing Title: GT-46401-3612, ICT/ITE Power Supply, Efficiency Level: USA DOE Level VI / Eco-design Directive 2009/125/EC, (EU) 2019/1782, Case Color/Style: GlobTek Black, Wall Plug-in, Regulated Switchmode AC-DC Power Supply AC Adaptor, Input Rating: 100-240V~, 50-60 Hz, Interchangeable Blades, https://www.globtek.com/interchangeable-blades.php, Output Rating: 36.00W, 12.0V@3.0A, Pin Out: Center Positive (+V), symbol compliant with IEC 60417 symbol no. 5926, Output Configuration: 1330 mm, 16/2 Cond, UL 2468, Female Barrel 5.5 * 2.5 * 11mm with internal Spring Clip and Locking Notch or Equal, Ferrite: Core Size: 14.2*28.5*8.2, GlobTek Black, GT Cord # C17701, Blades/Input Cord: (Order Separately), Approvals:</p>
	<p>Model No. GT-46401-3612</p>
	<p>Part No./Ordering No. WR9QE3000LCP-N(R6B) Rev F</p>

Notes/Modifications/Customizations (notes in this section supersede the values shown in the standard spec)
DIMENSIONS ARE IN MM UNLESS SPECIFIED OTHERWISE

GloTek, Inc. www.globtek.com 186 Veterans Drive, Northvale, NJ 07647 Tel. (201) 784-1000 Fax (201) 784-0111	Drawing Title: GT-46401-3612, ICT/ITE Power Supply, Efficiency Level: USA DOE Level VI / Eco-design Directive 2009/125/EC, (EU) 2019/1782, Case Color/Style: GlobTek Black, Wall Plug-in, Regulated Switchmode AC-DC Power Supply AC Adaptor, Input Rating: 100-240V~, 50-60 Hz, Interchangeable Blades, https://www.globtek.com/interchangeable-blades.php, Output Rating: 36.00W, 12.0V@3.0A, Pin Out: Center Positive (+V), symbol compliant with IEC 60417 symbol no. 5926, Output Configuration: 1330 mm, 16/2 Cond, UL 2468, Female Barrel 5.5 * 2.5 * 11mm with internal Spring Clip and Locking Notch or Equal, Ferrite: Core Size: 14.2*28.5*8.2, GlobTek Black, GT Cord # C17701, Blades/Input Cord: (Order Separately), Approvals:	
	Model No. GT-46401-3612	Part No./Ordering No. WR9QE3000LCP-N(R6B)

ELECTRICAL SPECIFICATIONS

A) ELECTRICAL SPECIFICATIONS:

01. Input Voltage: Specified 90-264 Vac, Nameplate rated: 100-240Vac
02. Input Frequency: Specified 47-63 Hz, Nameplate rated 50-60Hz
03. Inrush Current: 115Vac,(Cold Start) No damage, 230Vac,(Cold Start) No damage
04. Input Rated current: 1.0A RMS Max
05. Efficiency: 87.59% Min (CEC & DOE LEVEL VI Compliant), 88.30% Min (ErP European Commission's Ecodesign Directive (2005/32/EC) / CoC Tier 2 Compliant)
06. Input power(no load): <0.1W (CEC & DOE LEVEL VI Compliant), <0.075W (ErP European Commission's Ecodesign Directive (2005/32/EC) / CoC Tier 2 Compliant)
07. Load regulation: $\pm 5\%$
07. Output Voltage: Tolerance $\pm 5\%$
09. Leakage current: <0.25mA
10. Ripple Voltage: +/-1% or 150 mV whichever is greater, measured at 20 MHz bandwidth with 0.1 uf ceramic capacitor in parallel with 10 uf electrolytic capacitor connected at the end of the output connector at nominal line.

B) PROTECTION

01. Over voltage protected.
02. Short circuit protection: Output shut down and auto recover
- 03.Over Load Protected: Output auto recover

C) SAFETY

01. HI-POT : Input to output : 3000VAC or 4242VDC 10mA 1 minute
- 02.Insulation resistance: Input to output: 500vdc to test the input to output resistance not be less 100M ohm
03. Touch Current: <0.25mA @ 240Vac input voltage

D) EMC

01. Emissions, per EN 55032, EN 61000-6-3, EN 61000-6-4
 - Conducted Emissions: Class B, FCC Part 15, Class B
 - Radiated Emissions: Class B, FCC Part 15, Class B
02. Line Frequency Harmonics EN61000-3-2, Class A
03. Voltage Fluctuations/Flicker EN61000-3-3
04. Immunity, per EN 55024, EN 61000-6-1, EN 61000-6-2
 - Static Discharge Immunity EN61000-4-2, 4kV Contact Discharge, 8kV air discharge
 - Radiated RF Immunity EN61000-4-3, 3V/m 80-1000MHz, 80% 1KHz AM.
 - EFT/Burst Immunity EN61000-4-4, 1kV/100kHz.
 - Line Surge Immunity EN61000-4-5, 1kV differential, 2kV common-mode
 - Conducted RF Immunity EN61000-4-6, 3Vrms, 80% 1KHz AM
 - Power Frequency Magnetic Field Immunity EN61000-4-8, 1A/m
 - Voltage Dip Immunity EN61000-4-11, Criteria

E) OTHER:

01. MTBF: 200,000 Hours @ 25°C ambient temperature
02. Operating Temperature: 0°C to 40°C ambient temperature
03. Optional version with -40°C to 40°C operating temperature is available (RFP3927)

PROPRIETARY INFORMATION

PROPRIETARY OF GLOBTEK, INC. ANY REPRODUCTION, DISCLOSURE OR USE OF THIS DRAWING, IN WHOLE OR IN PART, IS HEREBY PROHIBITED EXCEPT AS SPECIFIED IN

WRITING BY GLOBTEK, INC. © GlobTek, Inc. 2015 - 2024

quest / 12/24/2024 2:23:46 AM GMT CLONED FROM WR9QE2080C9PNIKMT(R)

<p>GlobTek, Inc. www.globtek.com 186 Veterans Drive, Northvale, NJ 07647 Tel. (201) 784-1000 Fax (201) 784-0111</p>	<p>Drawing Title: GT-46401-3612, ICT/ITE Power Supply, Efficiency Level: USA DOE Level VI / Eco-design Directive 2009/125/EC, (EU) 2019/1782, Case Color/Style: GlobTek Black, Wall Plug-in, Regulated Switchmode AC-DC Power Supply AC Adaptor, Input Rating: 100-240V~, 50-60 Hz, Interchangeable Blades, https://www.globtek.com/interchangeable-blades.php, Output Rating: 36.00W, 12.0V@3.0A, Pin Out: Center Positive (+V), symbol compliant with IEC 60417 symbol no. 5926, Output Configuration: 1330 mm, 16/2 Cond, UL 2468, Female Barrel 5.5 * 2.5 * 11mm with internal Spring Clip and Locking Notch or Equal, Ferrite: Core Size: 14.2*28.5*8.2, GlobTek Black, GT Cord # C17701, Blades/Input Cord: (Order Separately), Approvals:</p>
	<p>Model No. GT-46401-3612</p>
	<p>Part No./Ordering No. WR9QE3000LCP-N(R6B) Rev F</p>

04. Humidity Operating : 15% to 95% RH
05. Elevation up to 4000 m
06. Storage Temperature: -10°C to 70°C
Humidity Storage: 5% to 95% RH
07. RoHS 2: Complies with EU 2011/65/EU and China GB/T26572-2011

F) ENCLOSURE

<p>GlobTek, Inc. www.globtek.com 186 Veterans Drive, Northvale, NJ 07647 Tel. (201) 784-1000 Fax (201) 784-0111</p>	<p>Drawing Title: GT-46401-3612, ICT/ITE Power Supply, Efficiency Level: USA DOE Level VI / Eco-design Directive 2009/125/EC, (EU) 2019/1782, Case Color/Style: GlobTek Black, Wall Plug-in, Regulated Switchmode AC-DC Power Supply AC Adaptor, Input Rating: 100-240V~, 50-60 Hz, Interchangeable Blades, https://www.globtek.com/interchangeable-blades.php, Output Rating: 36.00W, 12.0V@3.0A, Pin Out: Center Positive (+V), symbol compliant with IEC 60417 symbol no. 5926, Output Configuration: 1330 mm, 16/2 Cond, UL 2468, Female Barrel 5.5 * 2.5 * 11mm with internal Spring Clip and Locking Notch or Equal, Ferrite: Core Size: 14.2*28.5*8.2, GlobTek Black, GT Cord # C17701, Blades/Input Cord: (Order Separately), Approvals:</p>
	<p>Model No. GT-46401-3612</p>
	<p>Part No./Ordering No. WR9QE3000LCP-N(R6B) Rev F</p>

- 01. Housing: High impact plastic, 94V0 polycarbonate, non-vented
- 02. Size: 90.0 x 38.0 x 59.4 +/-1.0 mm
- 03. Markings: Label and/or Pad Printed and/or Molded in the case

TO ADDRESS SYSTEM-LEVEL EMI CONCERNS, FERRITE CHOKES/BEADS MAY BE ADDED/REVISED UPON REQUEST. A SAMPLE KIT OF GLOBTEK'S STANDARD FERRITES IS AVAILABLE UNDER GLOBTEK P/N: EMI-MITIGATION-KIT1

FOR ADDITIONAL INFORMATION, PLEASE READ OUR WHITE PAPER AT: <https://r.globtek.info/3QeaqtD>

INGRESS PROTECTION: Indoor Use

<p>GlobTek, Inc. www.globtek.com 186 Veterans Drive, Northvale, NJ 07647 Tel. (201) 784-1000 Fax (201) 784-0111</p>	<p>Drawing Title: GT-46401-3612, ICT/ITE Power Supply, Efficiency Level: USA DOE Level VI / Eco-design Directive 2009/125/EC, (EU) 2019/1782, Case Color/Style: GlobTek Black, Wall Plug-in, Regulated Switchmode AC-DC Power Supply AC Adaptor, Input Rating: 100-240V~, 50-60 Hz, Interchangeable Blades, https://www.globtek.com/interchangeable-blades.php, Output Rating: 36.00W, 12.0V@3.0A, Pin Out: Center Positive (+V), symbol compliant with IEC 60417 symbol no. 5926, Output Configuration: 1330 mm, 16/2 Cond, UL 2468, Female Barrel 5.5 * 2.5 * 11mm with internal Spring Clip and Locking Notch or Equal, Ferrite: Core Size: 14.2*28.5*8.2, GlobTek Black, GT Cord # C17701, Blades/Input Cord: (Order Separately), Approvals:</p>	<p>Model No. GT-46401-3612</p> <p>Part No./Ordering No. WR9QE3000LCP-N(R6B) Rev F</p>
--	---	--

3D File Download https://www.globtek.com/file/dl/gt-46401-wwwv-x-q_asm.stp

Mechanical drawing

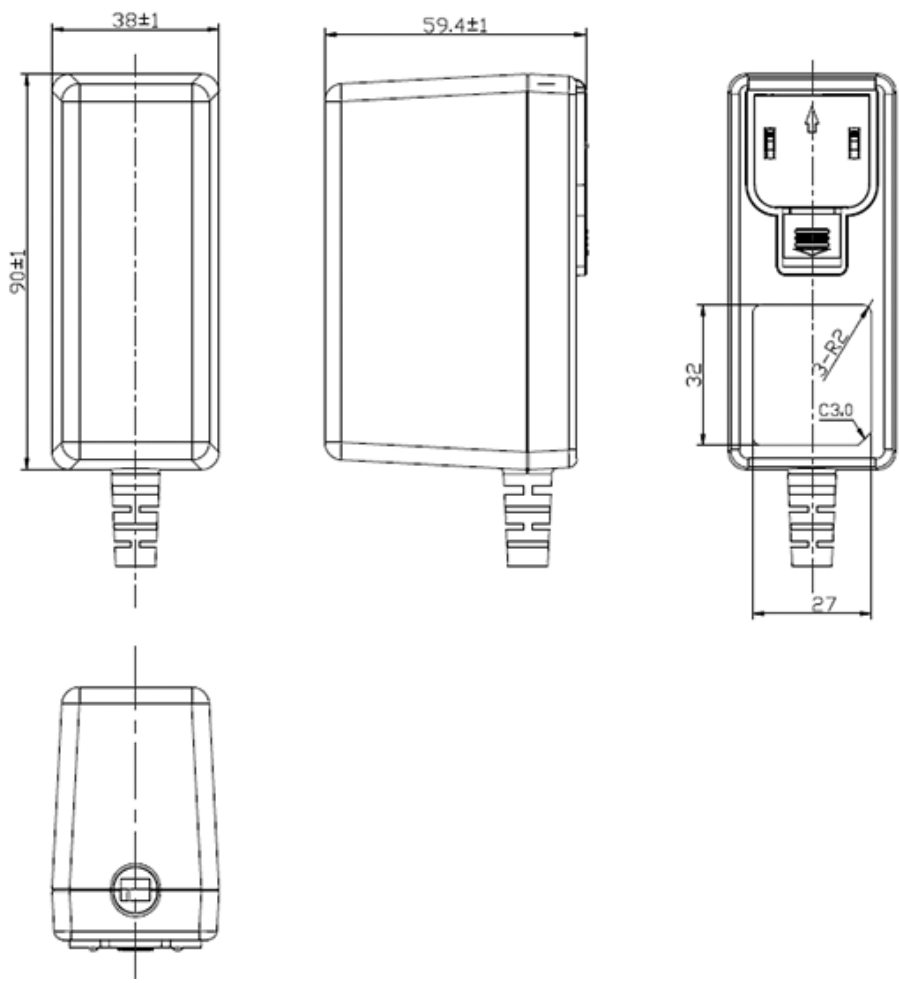

<p>GlobTek, Inc. www.globtek.com 186 Veterans Drive, Northvale, NJ 07647 Tel. (201) 784-1000 Fax (201) 784-0111</p>	<p>Drawing Title: GT-46401-3612, ICT/ITE Power Supply, Efficiency Level: USA DOE Level VI / Eco-design Directive 2009/125/EC, (EU) 2019/1782, Case Color/Style: GlobTek Black, Wall Plug-in, Regulated Switchmode AC-DC Power Supply AC Adaptor, Input Rating: 100-240V~, 50-60 Hz, Interchangeable Blades, https://www.globtek.com/interchangeable-blades.php, Output Rating: 36.00W, 12.0V@3.0A, Pin Out: Center Positive (+V), symbol compliant with IEC 60417 symbol no. 5926, Output Configuration: 1330 mm, 16/2 Cond, UL 2468, Female Barrel 5.5 * 2.5 * 11mm with internal Spring Clip and Locking Notch or Equal, Ferrite: Core Size: 14.2*28.5*8.2, GlobTek Black, GT Cord # C17701, Blades/Input Cord: (Order Separately), Approvals:</p>	<p>Model No. GT-46401-3612</p> <hr/> <p>Part No./Ordering No. WR9QE3000LCP-N(R6B) Rev F</p>
--	---	--

DERATING CURVE

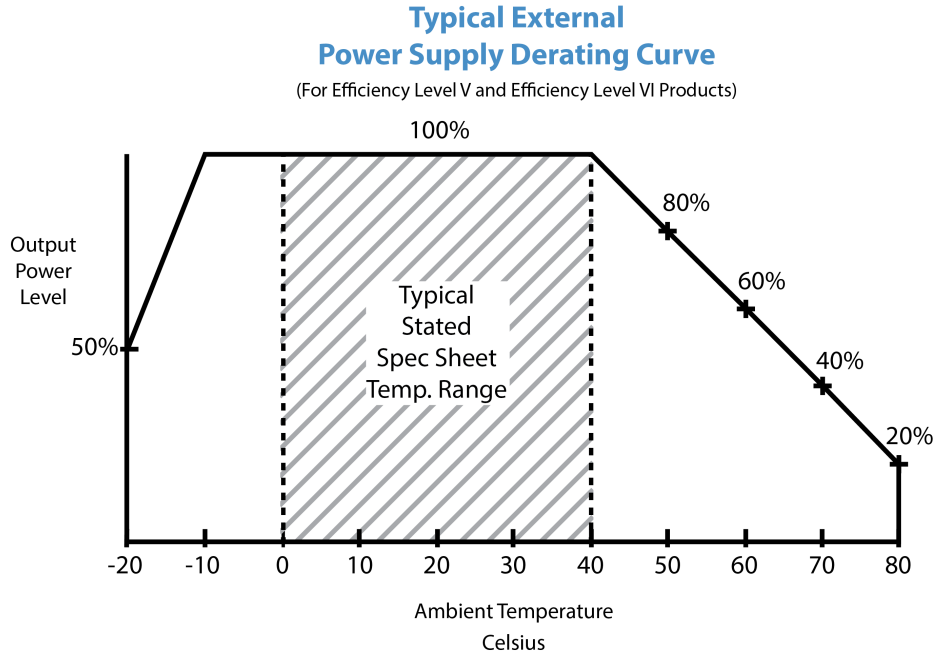

<p>GlobTek, Inc. www.globtek.com 186 Veterans Drive, Northvale, NJ 07647 Tel. (201) 784-1000 Fax (201) 784-0111</p>	<p>Drawing Title: GT-46401-3612, ICT/ITE Power Supply, Efficiency Level: USA DOE Level VI / Eco-design Directive 2009/125/EC, (EU) 2019/1782, Case Color/Style: GlobTek Black, Wall Plug-in, Regulated Switchmode AC-DC Power Supply AC Adaptor, Input Rating: 100-240V~, 50-60 Hz, Interchangeable Blades, https://www.globtek.com/interchangeable-blades.php, Output Rating: 36.00W, 12.0V@3.0A, Pin Out: Center Positive (+V), symbol compliant with IEC 60417 symbol no. 5926, Output Configuration: 1330 mm, 16/2 Cond, UL 2468, Female Barrel 5.5 * 2.5 * 11mm with internal Spring Clip and Locking Notch or Equal, Ferrite: Core Size: 14.2*28.5*8.2, GlobTek Black, GT Cord # C17701, Blades/Input Cord: (Order Separately), Approvals:</p>
	<p>Model No. GT-46401-3612</p>
	<p>Part No./Ordering No. WR9QE3000LCP-N(R6B) Rev F</p>

INPUT CONFIGURATION

(F1) Floating output, Class II / double insulated

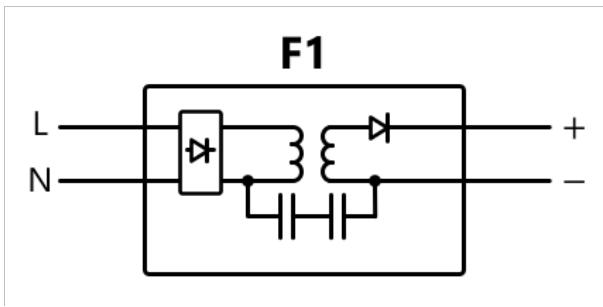

[Alternate grounding configurations](#) available upon request.

Blades/Cord Included:None:(Order Separately)

Blades/Cord Installed:None:(Order Separately)

Q Blades (Interchangeable)

Blade Options for Q Series Wall Plug-in Power Supplies

<p>GlobTek, Inc. www.globtek.com 186 Veterans Drive, Northvale, NJ 07647 Tel. (201) 784-1000 Fax (201) 784-0111</p>	<p>Drawing Title: GT-46401-3612, ICT/ITE Power Supply, Efficiency Level: USA DOE Level VI / Eco-design Directive 2009/125/EC, (EU) 2019/1782, Case Color/Style: GlobTek Black, Wall Plug-in, Regulated Switchmode AC-DC Power Supply AC Adaptor, Input Rating: 100-240V~, 50-60 Hz, Interchangeable Blades, https://www.globtek.com/interchangeable-blades.php, Output Rating: 36.00W, 12.0V@3.0A, Pin Out: Center Positive (+V), symbol compliant with IEC 60417 symbol no. 5926, Output Configuration: 1330 mm, 16/2 Cond, UL 2468, Female Barrel 5.5 * 2.5 * 11mm with internal Spring Clip and Locking Notch or Equal, Ferrite: Core Size: 14.2*28.5*8.2, GlobTek Black, GT Cord # C17701, Blades/Input Cord: (Order Separately), Approvals:</p>
	<p>Model No. GT-46401-3612</p>
	<p>Part No./Ordering No. WR9QE3000LCP-N(R6B) Rev F</p>

Data Sheet: <http://en.globtek.com/interchangeable-blades.php>

Insertion Instructions: <http://www.globtek.com/pdf/Instructions-Interchangeable-Blades.pdf>

Video: [Q-Blade Style Instruction Video](#)

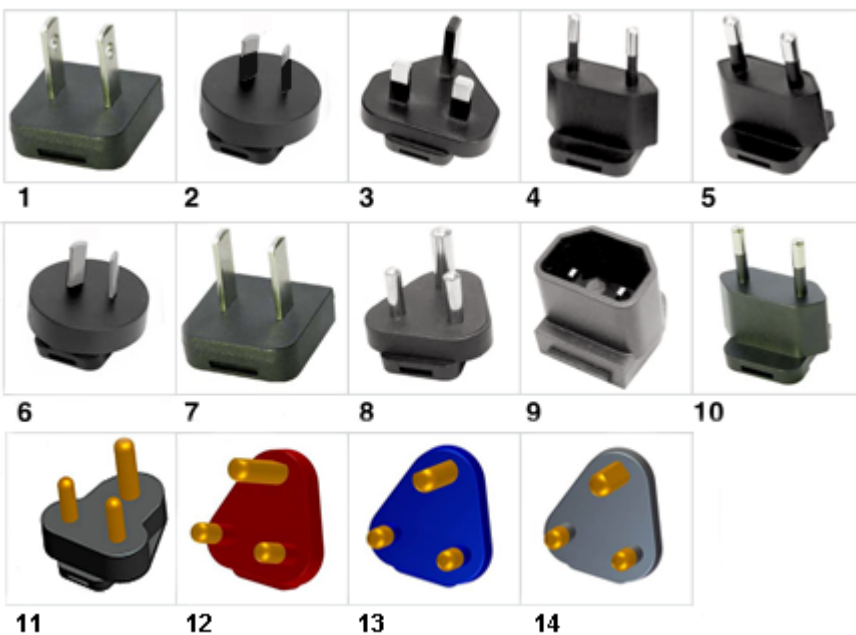

INPUT CONNECTOR: Q-Socket (below are available blades configurations which are "not included" (unless stated above); can be purchased separately, package with power supply or as a separate "Q-KIT" if specified

GlobTek, Inc. www.globtek.com 186 Veterans Drive, Northvale, NJ 07647 Tel. (201) 784-1000 Fax (201) 784-0111	Drawing Title: GT-46401-3612, ICT/ITE Power Supply, Efficiency Level: USA DOE Level VI / Eco-design Directive 2009/125/EC, (EU) 2019/1782, Case Color/Style: GlobTek Black, Wall Plug-in, Regulated Switchmode AC-DC Power Supply AC Adaptor, Input Rating: 100-240V~, 50-60 Hz, Interchangeable Blades, https://www.globtek.com/interchangeable-blades.php , Output Rating: 36.00W, 12.0V@3.0A, Pin Out: Center Positive (+V), symbol compliant with IEC 60417 symbol no. 5926, Output Configuration: 1330 mm, 16/2 Cond, UL 2468, Female Barrel 5.5 * 2.5 * 11mm with internal Spring Clip and Locking Notch or Equal, Ferrite: Core Size: 14.2*28.5*8.2, GlobTek Black, GT Cord # C17701, Blades/Input Cord: (Order Separately), Approvals:	
	Model No. GT-46401-3612	
	Part No./Ordering No. WR9QE3000LCP-N(R6B)	Rev F

01. United States / Canada / Japan NEMA 1-15P/ IEC PLUG Type A [WORKS IN PLUG B] configuration: NA 2 blades, Class II; US/CA/JP P/N: Q-NA(R)
02. Australian AS 3112 configuration: SAA 2 blade/ IEC TYPE I, Class II; AU P/N: Q-SAA(R)
03. UK BS 1363 configuration: UK 3 blade with dummy Ground/ IEC TYPE G, Class II; GB P/N: Q-UK(R)
04. European CEE 7/16 configuration: Europlug 2 pins/ IEC TYPE C [WORKS IN TYPE E&F], Class II; EU P/N: Q-EU(R)
05. Korean KS C8305 configuration: 2 pins/SIMILAR TO IEC TYPE C, Class II; KR P/N: Q-KR(R)
06. Argentina IRAM 2073 configuration: 2 blades/SIMILAR TO IEC TYPE I; AR P/N: Class II Q-AR(R)
07. China GB 2099 configuration: 2 blades/SIMILAR TO TYPE A, Class II; CN P/N:Q-CN(R)
08. India IS 1293 6A/BS546 configuration: 5A, 3 pins with Dummy Ground, Class II/IEC TYPE D; IN P/N: Q-IN(R)
09. IEC60320/C18 Inlet, Class II; P/N: Q-C18(R)
10. Brazilian NBR6147 configuration: 2 pins, Class II;SIMILAR TO IEC TYPE C BR P/N: Q-BR(R)
11. South Africa SABS164-1 and India IS 1293, IS694, 16A type plug, 3 round prongs, Class II + dummy ground, IEC TYPE M P/N: Q-SANS164-1-16A(R)
12. South Africa SABS164-4, 3 round prongs with a notched prong @ 0°, Class II + dummy ground, IEC TYPE M Red, P/N: Q-SANS164-4C-16A(R)
13. South Africa SABS164-4, 3 round prongs with a notched prong @ -53°, Class II + dummy ground, Blue, IEC TYPE M, P/N: Q-SANS164-4L-16A(R)
14. South Africa SABS164-4, 3 round prongs with a notched prong @ +53°, Class II + dummy ground, Black,IEC TYPE M P/N: Q-SANS164-4R-16A(R)

Kits

01. Q-KIT: 1,2,3,4 above
02. Q-KIT-INTL: 2,3,4 above
03. Q-KIT-6: 1,2,3,4,5,6 above
04. Q-KIT-7: 1,2,3,4,5,6,7 above
05. Q-KIT-8: 1,2,3,4,5,6,7,8 above

PROPRIETARY INFORMATION

GlobTek, Inc. www.globtek.com 186 Veterans Drive, Northvale, NJ 07647 Tel. (201) 784-1000 Fax (201) 784-0111	Drawing Title: GT-46401-3612, ICT/ITE Power Supply, Efficiency Level: USA DOE Level VI / Eco-design Directive 2009/125/EC, (EU) 2019/1782, Case Color/Style: GlobTek Black, Wall Plug-in, Regulated Switchmode AC-DC Power Supply AC Adaptor, Input Rating: 100-240V~, 50-60 Hz, Interchangeable Blades, https://www.globtek.com/interchangeable-blades.php , Output Rating: 36.00W, 12.0V@3.0A, Pin Out: Center Positive (+V), symbol compliant with IEC 60417 symbol no. 5926, Output Configuration: 1330 mm, 16/2 Cond, UL 2468, Female Barrel 5.5 * 2.5 * 11mm with internal Spring Clip and Locking Notch or Equal, Ferrite: Core Size: 14.2*28.5*8.2, GlobTek Black, GT Cord # C17701, Blades/Input Cord: (Order Separately), Approvals:	
	Model No. GT-46401-3612	Part No./Ordering No. WR9QE3000LCP-N(R6B)

OUTPUT CORD AND CONNECTOR: LCL/C17701

ACTUAL CONNECTORS, OVERMOLDS, FERRITES MAY VARY SLIGHTLY FROM THE PICTURE BELOW

CABLE TYPE	UL 2468
CABLE LENGTH (mm)	1330
CABLE TOLERANCE (mm)	+100, -100
WIRE GAUGE (AWG)	16
CONDUCTORS	2
HANK DIMENSION (mm)	95 ±10
CABLE / CONNECTOR OVERMOLD COLOR	GlobTek Black
FERRITE TYPE AND DIMENSION	Core Size: 14.2*28.5*8.2
FERRITE NUMBER OF TURNS(Definition)	2 Pass thru core (1 turns)
FERRITE DIMENSION FROM STRAIN RELIEF	50 ±10
FERRITE DIMENSION FROM PLUG	N/A
PLUG TYPE	Female Barrel 5.5 * 2.5 * 11mm with internal Spring Clip and Locking Notch or Equal
OVERMOLDED	Yes
OVER MOLD ORIENTATION	Straight
CONNECTOR PIN OUT	Center Positive (+V), symbol compliant with IEC 60417 symbol no. 5926

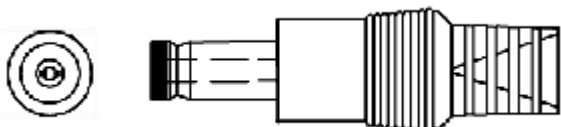

ADDITIONAL OUTPUT PLUG OPTIONS ARE AVAILABLE AT <https://www.globtek.com/en/connectors>
STANDARD PLUGS AND CONNECTORS CAN BE SEEN ONLINE AT <https://www.globtek.com/en/connectors>
CALCULATE VOLTAGE REGULATION/DROP WITH OUR ONLINE CALCULATOR: <https://www.globtek.com/r2/PtqjL>

<p>GlobTek, Inc. www.globtek.com 186 Veterans Drive, Northvale, NJ 07647 Tel. (201) 784-1000 Fax (201) 784-0111</p>	<p>Drawing Title: GT-46401-3612, ICT/ITE Power Supply, Efficiency Level: USA DOE Level VI / Eco-design Directive 2009/125/EC, (EU) 2019/1782, Case Color/Style: GlobTek Black, Wall Plug-in, Regulated Switchmode AC-DC Power Supply AC Adaptor, Input Rating: 100-240V~, 50-60 Hz, Interchangeable Blades, https://www.globtek.com/interchangeable-blades.php, Output Rating: 36.00W, 12.0V@3.0A, Pin Out: Center Positive (+V), symbol compliant with IEC 60417 symbol no. 5926, Output Configuration: 1330 mm, 16/2 Cond, UL 2468, Female Barrel 5.5 * 2.5 * 11mm with internal Spring Clip and Locking Notch or Equal, Ferrite: Core Size: 14.2*28.5*8.2, GlobTek Black, GT Cord # C17701, Blades/Input Cord: (Order Separately), Approvals:</p>
	<p>Model No. GT-46401-3612</p>
	<p>Part No./Ordering No. WR9QE3000LCP-N(R6B) Rev F</p>

OUTPUT CONNECTOR HOOK UP

TO ADDRESS SYSTEM-LEVEL EMI CONCERNS, FERRITE CHOKES/BEADS MAY BE ADDED/REVISED UPON REQUEST. A SAMPLE KIT OF GLOBTEK'S STANDARD FERRITES IS AVAILABLE UNDER GLOBTEK P/N: EMI-MITIGATION-KIT1

FOR ADDITIONAL INFORMATION, PLEASE READ OUR WHITE PAPER AT:

<https://www.globtek.com/en/technical-articles/ferrite-kit-radiated-emi-suppression-kit-for-globtek-power-supplies-cable-assemblies>

GlobTek, Inc. www.globtek.com 186 Veterans Drive, Northvale, NJ 07647 Tel. (201) 784-1000 Fax (201) 784-0111	Drawing Title: GT-46401-3612, ICT/ITE Power Supply, Efficiency Level: USA DOE Level VI / Eco-design Directive 2009/125/EC, (EU) 2019/1782, Case Color/Style: GlobTek Black, Wall Plug-in, Regulated Switchmode AC-DC Power Supply AC Adaptor, Input Rating: 100-240V~, 50-60 Hz, Interchangeable Blades, https://www.globtek.com/interchangeable-blades.php , Output Rating: 36.00W, 12.0V@3.0A, Pin Out: Center Positive (+V), symbol compliant with IEC 60417 symbol no. 5926, Output Configuration: 1330 mm, 16/2 Cond, UL 2468, Female Barrel 5.5 * 2.5 * 11mm with internal Spring Clip and Locking Notch or Equal, Ferrite: Core Size: 14.2*28.5*8.2, GlobTek Black, GT Cord # C17701, Blades/Input Cord: (Order Separately), Approvals:	
	Model No. GT-46401-3612	Part No./Ordering No. WR9QE3000LCP-N(R6B)
		Rev F

LABEL:L-1186

LABEL P/N	Standard GT
MATERIAL	Flat Thermal Transfer, Imprintable, Polyester Label and/or Pad Printed and/or Molded, and/or Laser Engraved in the case
BACKGROUND COLOR	Black if housing is Black, White or Silver if housing is White or Gray.
TEXT COLOR	White or Silver if label is Black Background for Black housing. Black if label is White or Silver background and Housing is White or Gray.
LABEL WIDTH (mm)	32.0
LABEL HEIGHT (mm)	27.0
SPECIAL BARCODE LABEL MATERIAL	No

Below is the minimum information which will appear on the label. NOTE: in the logo area additional/actual positioning of symbols and text is subjected to change as per agency updates/requirements or additional model approvals become available. Regulatory certifications/label markings may be in logo area on the label or molded into the case housing outside the label area. Information will be shown via label and/or pad printed and/or molded and/or laser engraved in the case. * Date code markings at GlobTek option

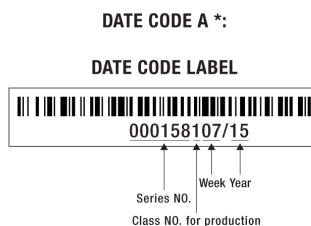



or
DATE CODE B *:

WWYY
WW = WEEK
YY = YEAR

- A=ICT/ITE Power Supply
- B=P/N: (料号) WR9QE3000LCP-N(R6B)
- C=Model (型号) GT-46401-3612
- D=Input (输入)100-240V~, 50-60 Hz, 1.0A
- E=Output (输出)12.0 V 3.0 A, 36.00W

GlobTek, Inc. www.globtek.com 186 Veterans Drive, Northvale, NJ 07647 Tel. (201) 784-1000 Fax (201) 784-0111	Drawing Title: GT-46401-3612, ICT/ITE Power Supply, Efficiency Level: USA DOE Level VI / Eco-design Directive 2009/125/EC, (EU) 2019/1782, Case Color/Style: GlobTek Black, Wall Plug-in, Regulated Switchmode AC-DC Power Supply AC Adaptor, Input Rating: 100-240V~, 50-60 Hz, Interchangeable Blades, https://www.globtek.com/interchangeable-blades.php , Output Rating: 36.00W, 12.0V@3.0A, Pin Out: Center Positive (+V), symbol compliant with IEC 60417 symbol no. 5926, Output Configuration: 1330 mm, 16/2 Cond, UL 2468, Female Barrel 5.5 * 2.5 * 11mm with internal Spring Clip and Locking Notch or Equal, Ferrite: Core Size: 14.2*28.5*8.2, GlobTek Black, GT Cord # C17701, Blades/Input Cord: (Order Separately), Approvals:	
	Model No. GT-46401-3612	
	Part No./Ordering No. WR9QE3000LCP-N(R6B)	Rev F

AGENCY ONLINE DOCUMENTS	http://www.globtek.info/certs/GT-46401-WVVV-X.X/
CE EC-Declaration for Medical	Contact GlobTek for more information
CE EC-Declaration for Industrial/Commercial/ITE	https://cs.globtek.info/ec_declaration_product?id=01ta0000006Fczs&i=2
CE EC-Declaration for Household	Contact GlobTek for more information
UKCA-Declaration for Medical	Contact GlobTek for more information
UKCA-Declaration for Industrial/Commercial/ITE	https://cs.globtek.info/ukca_declaration_product?id=01ta0000006Fczs&i=2
UKCA-Declaration for Household	Contact GlobTek for more information
Morocco SDoC Declaration	https://cs.globtek.info/Morocco_SDoC_Declaration?id=a00a000000NrvmWEAR
RoHS/RoHS3 Declaration	https://www.globtek.com/pdf/rohs_cert/01ta0000006FczsAAC
REACH Declaration	https://www.globtek.com/pdf/iso_certificates/REACH.pdf
Conflict Minerals Declaration	https://www.globtek.com/pdf/conflict-minerals.pdf
Prop 65 Statement	https://www.globtek.com/prop-65-statement.pdf
IPXY rating is based on 3rd party testing and customers should check suitability and test system level IPXY rating before ordering.	
<h2>Regulatory Certifications/Label Markings</h2>	
<p>Below follows a link to the latest regulatory certifications and marks for this specific product. National standards as well as certification schemes are constantly changing and so is the set of certification marks and symbols applicable to this product. Various standards, marks and symbols, and certificates are subject to change at any time without notice.</p> <p>Additional standards or unique country certifications are available upon request. Please contact Globtek to request a quotation.</p> <p>LATEST PRODUCT/MODEL CERTIFICATIONS: https://www.globtek.com/ds/9jL62bmmMWz/ympuBwG5rDe.html</p>	
AGENCY ONLINE DOCUMENTS	http://www.globtek.info/certs/GT-46401-WVVV-X.X/
	(F1) Floating output, Class II / double insulated
	Center Positive (+V), symbol compliant with IEC 60417 symbol no. 5926

GlobTek, Inc. www.globtek.com 186 Veterans Drive, Northvale, NJ 07647 Tel. (201) 784-1000 Fax (201) 784-0111	Drawing Title: GT-46401-3612, ICT/ITE Power Supply, Efficiency Level: USA DOE Level VI / Eco-design Directive 2009/125/EC, (EU) 2019/1782, Case Color/Style: GlobTek Black, Wall Plug-in, Regulated Switchmode AC-DC Power Supply AC Adaptor, Input Rating: 100-240V~, 50-60 Hz, Interchangeable Blades, https://www.globtek.com/interchangeable-blades.php , Output Rating: 36.00W, 12.0V@3.0A, Pin Out: Center Positive (+V), symbol compliant with IEC 60417 symbol no. 5926, Output Configuration: 1330 mm, 16/2 Cond, UL 2468, Female Barrel 5.5 * 2.5 * 11mm with internal Spring Clip and Locking Notch or Equal, Ferrite: Core Size: 14.2*28.5*8.2, GlobTek Black, GT Cord # C17701, Blades/Input Cord: (Order Separately), Approvals:	
	Model No. GT-46401-3612	
	Part No./Ordering No. WR9QE3000LCP-N(R6B)	Rev F

PACKAGING

Packing Spec P/N	Standard WPI for GT-46401, user manual
Packing Quantity/Multiple/MPQ	60
Gift Box Size (mm)	122*60*66
Gift Box Color	None
Master Carton Size (mm)	508 x 355 x 205
Master Carton Cubic Volume (m ³)	0.04
Master GW (Kg)	10.8 kg
BLADES INCLUDED	None: (Order Separately)
BLADE/CORD INSTALLED	None: (Order Separately)
USER MANUAL*	809-PSUQKITUSERMANUAL on A4 paper
USER MANUAL WEB LINK	https://www.globtek.com/pdf/809-PSUQKITUSERMANUAL.jpg

* This specification sheet is considered the user manual for all applications. It is expected that the buyer of this product will use it to formulate their own user manual for their end product and a user manual specifically for the power adapter is not usually required. If a user manual is not specifically listed above then none will be provided with this unit.

<p>GlobTek, Inc. www.globtek.com 186 Veterans Drive, Northvale, NJ 07647 Tel. (201) 784-1000 Fax (201) 784-0111</p>	<p>Drawing Title: GT-46401-3612, ICT/ITE Power Supply, Efficiency Level: USA DOE Level VI / Eco-design Directive 2009/125/EC, (EU) 2019/1782, Case Color/Style: GlobTek Black, Wall Plug-in, Regulated Switchmode AC-DC Power Supply AC Adaptor, Input Rating: 100-240V~, 50-60 Hz, Interchangeable Blades, https://www.globtek.com/interchangeable-blades.php, Output Rating: 36.00W, 12.0V@3.0A, Pin Out: Center Positive (+V), symbol compliant with IEC 60417 symbol no. 5926, Output Configuration: 1330 mm, 16/2 Cond, UL 2468, Female Barrel 5.5 * 2.5 * 11mm with internal Spring Clip and Locking Notch or Equal, Ferrite: Core Size: 14.2*28.5*8.2, GlobTek Black, GT Cord # C17701, Blades/Input Cord: (Order Separately), Approvals:</p>	<p>Model No. GT-46401-3612</p> <p>Part No./Ordering No. WR9QE3000LCP-N(R6B) Rev F</p>
--	---	--

If specific packaging is required, this section must specify all requirements and note "no exceptions". If this section does not specify packaging, it is subject to change without notice at GlobTek's discretion

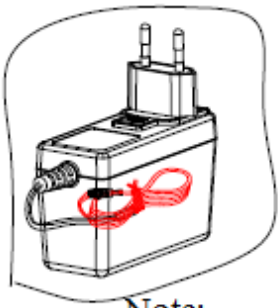
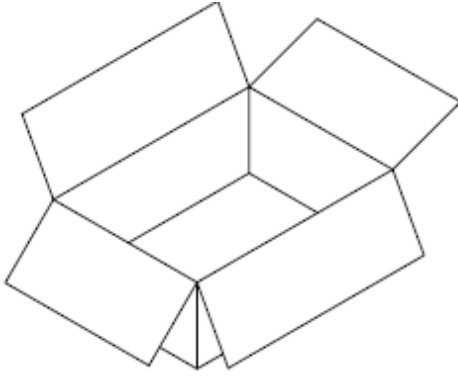

Note:
PE bag only works for
PSU, not for cable.

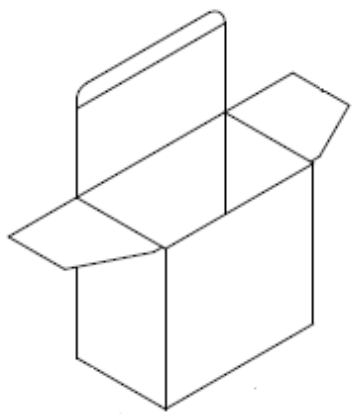
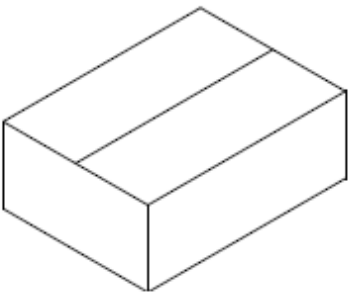

<p>GlobTek, Inc. www.globtek.com 186 Veterans Drive, Northvale, NJ 07647 Tel. (201) 784-1000 Fax (201) 784-0111</p>	<p>Drawing Title: GT-46401-3612, ICT/ITE Power Supply, Efficiency Level: USA DOE Level VI / Eco-design Directive 2009/125/EC, (EU) 2019/1782, Case Color/Style: GlobTek Black, Wall Plug-in, Regulated Switchmode AC-DC Power Supply AC Adaptor, Input Rating: 100-240V~, 50-60 Hz, Interchangeable Blades, https://www.globtek.com/interchangeable-blades.php, Output Rating: 36.00W, 12.0V@3.0A, Pin Out: Center Positive (+V), symbol compliant with IEC 60417 symbol no. 5926, Output Configuration: 1330 mm, 16/2 Cond, UL 2468, Female Barrel 5.5 * 2.5 * 11mm with internal Spring Clip and Locking Notch or Equal, Ferrite: Core Size: 14.2*28.5*8.2, GlobTek Black, GT Cord # C17701, Blades/Input Cord: (Order Separately), Approvals:</p>
	<p>Model No. GT-46401-3612</p>
	<p>Part No./Ordering No. WR9QE3000LCP-N(R6B) Rev F</p>

INSTRUCTIONS TO THE OEM SYSTEMS ENGINEER

It is the responsibility of the OEM systems engineer to provide the end system user instructions and warnings for the use of this product in the end system.

If an input cord is required for this product, AC Mains voltage should be provided to the power supply by a power supply cord approved to the national standards of the country in which it will be used.

This product is not designed to be repaired. No serviceable parts inside. A blown internal fuse is an indication of catastrophic failure of circuit component(s). If a Failure Analysis is required for a failed power supply/battery charger, please return the damaged unit to GlobTek for an accurate determination of the root cause of the failure.

EMC Compliance of the complete OEM product, including the GlobTek power supply/battery charger needs to be verified by the OEM systems engineer.

GlobTek, Inc. www.globtek.com 186 Veterans Drive, Northvale, NJ 07647 Tel. (201) 784-1000 Fax (201) 784-0111	Drawing Title: GT-46401-3612, ICT/ITE Power Supply, Efficiency Level: USA DOE Level VI / Eco-design Directive 2009/125/EC, (EU) 2019/1782, Case Color/Style: GlobTek Black, Wall Plug-in, Regulated Switchmode AC-DC Power Supply AC Adaptor, Input Rating: 100-240V~, 50-60 Hz, Interchangeable Blades, https://www.globtek.com/interchangeable-blades.php, Output Rating: 36.00W, 12.0V@3.0A, Pin Out: Center Positive (+V), symbol compliant with IEC 60417 symbol no. 5926, Output Configuration: 1330 mm, 16/2 Cond, UL 2468, Female Barrel 5.5 * 2.5 * 11mm with internal Spring Clip and Locking Notch or Equal, Ferrite: Core Size: 14.2*28.5*8.2, GlobTek Black, GT Cord # C17701, Blades/Input Cord: (Order Separately), Approvals:	
	Model No. GT-46401-3612	
	Part No./Ordering No. WR9QE3000LCP-N(R6B)	Rev F

INSTRUCTION SHEET

Q Blades Instruction Sheet (not required to be packaged with product)

Insertion Instructions: <http://www.globtek.com/pdf/Instructions-Interchangeable-Blades.pdf>

This manual is Provided to customer within the product specification - it is the responsibility of the OEM/customer to provide the end system user instructions + warnings for the use of this product in the end system. By accepting this specification the customer/OEM Agrees to these terms.

USER MANUAL FOR Q-BLADE SERIES SWITCHING POWER SUPPLIES

Manual del Usuario. Fuentes de Alimentación Series Q-Blade

WARNING! RISK OF FIRE! SHOCK HAZARD!: To prevent electric shock, do not remove the cover. No user-serviceable parts inside. This unit contains hazardous voltages and should only be opened by a trained and qualified technician. Do not use if bent, cracked, modified or compromised. To avoid the possibility of electric shock, disconnect electric power to the product before connecting or disconnecting.

Advertencia! Riesgo de Fuego! Peligro de Choque eléctrico! No contiene dentro componentes servibles para el usuario. Desconecte el cable de alimentación antes de quitar la cubierta.

INDOOR USE ONLY!

Únicamente para uso en el interior.

POWER SUPPLY BLADE/CORD: AC Mains voltage should be provided to the power supply by a power supply cords approved to the national standards in which it will be used. Please use the below table as a guideline for Suitable Power cords.

CABLE DE ALIMENTACIÓN: El voltaje de la CA debe proporcionarse a la fuente de alimentación mediante los cables de alimentación aprobados conforme a las normas nacionales según las cuales será utilizada. Utilice por favor la tabla mencionada aquí abajo como guía para los cables eléctricos adecuados.

<p>GlobTek, Inc. www.globtek.com 186 Veterans Drive, Northvale, NJ 07647 Tel. (201) 784-1000 Fax (201) 784-0111</p>	<p>Drawing Title: GT-46401-3612, ICT/ITE Power Supply, Efficiency Level: USA DOE Level VI / Eco-design Directive 2009/125/EC, (EU) 2019/1782, Case Color/Style: GlobTek Black, Wall Plug-in, Regulated Switchmode AC-DC Power Supply AC Adaptor, Input Rating: 100-240V~, 50-60 Hz, Interchangeable Blades, https://www.globtek.com/interchangeable-blades.php, Output Rating: 36.00W, 12.0V@3.0A, Pin Out: Center Positive (+V), symbol compliant with IEC 60417 symbol no. 5926, Output Configuration: 1330 mm, 16/2 Cond, UL 2468, Female Barrel 5.5 * 2.5 * 11mm with internal Spring Clip and Locking Notch or Equal, Ferrite: Core Size: 14.2*28.5*8.2, GlobTek Black, GT Cord # C17701, Blades/Input Cord: (Order Separately), Approvals:</p>
	<p>Model No. GT-46401-3612</p>
	<p>Part No./Ordering No. WR9QE3000LCP-N(R6B) Rev F</p>

1. Class II model NEMA 1-15P AC power plug with 2 prongs, Q-NA(R)
2. Australian AS 3112 configuration: SAA 2 pins Class II, Q-SAA(R)
3. UK BS 1363 configuration: UK 2 pins Class II, Q-UK(R)
4. European CEE 7/16 configuration: Europlug 2 PINS, Class II, Q-EU(R)
5. Korean KS C8305 configuration: Q-KR(R)
6. Argentina IRAM 2073 configuration: 2 pins, Class II Q-AR(R)
7. China GR 2099 configuration: 2 pins, Class II Q-CN(R)
8. India configuration: 2 pins, Class II, Q-IN(R)
9. IEC320/C18 Inlet

FUSING: Internal fuse for Line is provided in the power supply. A blown internal fuse is an indication of catastrophic failure of circuit component(s). Repair must be performed by GlobTek, Inc. authorized personnel. Fuses must be replaced with same type and ratings per GlobTek internal documentation.

<p>GlobTek, Inc. www.globtek.com 186 Veterans Drive, Northvale, NJ 07647 Tel. (201) 784-1000 Fax (201) 784-0111</p>	<p>Drawing Title: GT-46401-3612, ICT/ITE Power Supply, Efficiency Level: USA DOE Level VI / Eco-design Directive 2009/125/EC, (EU) 2019/1782, Case Color/Style: GlobTek Black, Wall Plug-in, Regulated Switchmode AC-DC Power Supply AC Adaptor, Input Rating: 100-240V~, 50-60 Hz, Interchangeable Blades, https://www.globtek.com/interchangeable-blades.php, Output Rating: 36.00W, 12.0V@3.0A, Pin Out: Center Positive (+V), symbol compliant with IEC 60417 symbol no. 5926, Output Configuration: 1330 mm, 16/2 Cond, UL 2468, Female Barrel 5.5 * 2.5 * 11mm with internal Spring Clip and Locking Notch or Equal, Ferrite: Core Size: 14.2*28.5*8.2, GlobTek Black, GT Cord # C17701, Blades/Input Cord: (Order Separately), Approvals:</p>	<p>Model No. GT-46401-3612 Part No./Ordering No. WR9QE3000LCP-N(R6B) Rev F</p>
--	---	--

FUSIBLES: La fuente de alimentación provee un fusible interno para la línea. Un fusible interno quemado es un indicador de una falla catastrófica de los componentes del circuito. La reparación debe ser hecha por personal autorizado de GlobTek, Inc. Los fusibles se deben reemplazar por los mismos tipos y rangos que la documentación interna de GlobTek mencione.

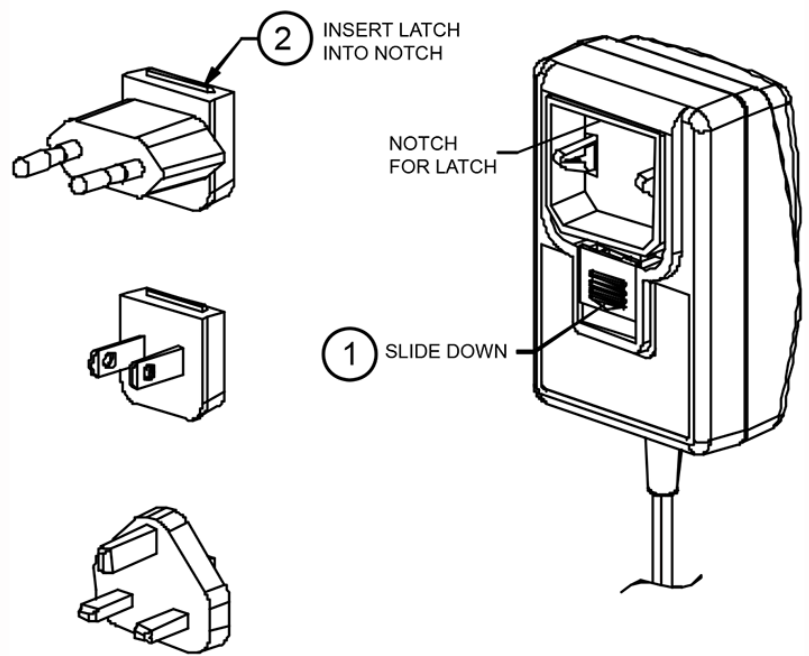

 This symbol on an instrument indicates that the user should refer to the operating instructions located in the manual.

Please note:
The blades shown above are for representation of the installation process and do not indicate which AC blades are included with this power supply. Please reference the specifications "Power Supply Information" (page 2) and "Input Configuration" (page 6) for information regarding the actual blade included with this power supply, if any.

<p>GlobTek, Inc. www.globtek.com 186 Veterans Drive, Northvale, NJ 07647 Tel. (201) 784-1000 Fax (201) 784-0111</p>	<p>Drawing Title: GT-46401-3612, ICT/ITE Power Supply, Efficiency Level: USA DOE Level VI / Eco-design Directive 2009/125/EC, (EU) 2019/1782, Case Color/Style: GlobTek Black, Wall Plug-in, Regulated Switchmode AC-DC Power Supply AC Adaptor, Input Rating: 100-240V~, 50-60 Hz, Interchangeable Blades, https://www.globtek.com/interchangeable-blades.php, Output Rating: 36.00W, 12.0V@3.0A, Pin Out: Center Positive (+V), symbol compliant with IEC 60417 symbol no. 5926, Output Configuration: 1330 mm, 16/2 Cond, UL 2468, Female Barrel 5.5 * 2.5 * 11mm with internal Spring Clip and Locking Notch or Equal, Ferrite: Core Size: 14.2*28.5*8.2, GlobTek Black, GT Cord # C17701, Blades/Input Cord: (Order Separately), Approvals:</p>
	<p>Model No. GT-46401-3612</p>
	<p>Part No./Ordering No. WR9QE3000LCP-N(R6B) Rev F</p>

TERMS AND CONDITIONS

THESE TERMS AND CONDITIONS GOVERN THE SALE OF ALL PRODUCTS AND SERVICES ("PRODUCTS") BY GlobTek, Inc. ("GlobTek") AND APPLY NOTWITHSTANDING ANY CONFLICTING, CONTRARY OR ADDITIONAL TERMS AND CONDITIONS IN ANY PURCHASE ORDER OR OTHER DOCUMENT OR COMMUNICATION ("PURCHASE ORDER") FROM BUYER. THESE TERMS AND CONDITIONS MAY ONLY BE WAIVED OR MODIFIED IN A WRITTEN AGREEMENT SIGNED BY AN AUTHORIZED REPRESENTATIVE OF THE SELLER. NEITHER SELLER'S ACKNOWLEDGEMENT OF A PURCHASE ORDER NOR SELLER'S FAILURE TO OBJECT TO CONFLICTING, CONTRARY OR ADDITIONAL TERMS AND CONDITIONS IN A PURCHASE ORDER SHALL BE DEEMED AN ACCEPTANCE OF SUCH TERMS AND CONDITIONS OR A WAIVER OF THE PROVISIONS HEREOF.

ORDERS:

1. Buyer must issue a Purchase Order or otherwise place an order by means acceptable to GlobTek. Orders shall identify the Products, unit quantities, part numbers, descriptions, applicable prices, ship to address and requested delivery dates. All orders are subject to acceptance by GlobTek. No order may be cancelled or rescheduled without GlobTek's consent. Consent may be given by GlobTek in its sole discretion. GlobTek reserves the right to add a Rescheduling Fee should Seller deem applicable. Seller reserves the right to allocate sales of Products among its customers in its sole discretion.

RESTOCKING TERMS:

1. Returning of stock items only: All claims must be made within ten (10) days of receipt of goods. GlobTek must authorize all returns. No return of product will be accepted without GlobTek's Return Merchandise Authorization (RMA) number. All authorized returns will be subject to a minimum of 25% restocking charge* and buyer must pay return freight to GlobTek. Parts must be in original condition and packaging.
2. *Custom items and/or dedicated production lots are not returnable.

<p>GlobTek, Inc. www.globtek.com 186 Veterans Drive, Northvale, NJ 07647 Tel. (201) 784-1000 Fax (201) 784-0111</p>	<p>Drawing Title: GT-46401-3612, ICT/ITE Power Supply, Efficiency Level: USA DOE Level VI / Eco-design Directive 2009/125/EC, (EU) 2019/1782, Case Color/Style: GlobTek Black, Wall Plug-in, Regulated Switchmode AC-DC Power Supply AC Adaptor, Input Rating: 100-240V~, 50-60 Hz, Interchangeable Blades, https://www.globtek.com/interchangeable-blades.php, Output Rating: 36.00W, 12.0V@3.0A, Pin Out: Center Positive (+V), symbol compliant with IEC 60417 symbol no. 5926, Output Configuration: 1330 mm, 16/2 Cond, UL 2468, Female Barrel 5.5 * 2.5 * 11mm with internal Spring Clip and Locking Notch or Equal, Ferrite: Core Size: 14.2*28.5*8.2, GlobTek Black, GT Cord # C17701, Blades/Input Cord: (Order Separately), Approvals:</p>
<p>Model No. GT-46401-3612</p>	
<p>Part No./Ordering No. WR9QE3000LCP-N(R6B)</p>	<p>Rev F</p>

RETURNED MERCHANDISE:

1. Replacement or credit will not be allowed for products returned without prior consent. No return of product will be accepted without a GlobTek RMA number. RMA requests for all goods that are found to be not in compliance with Seller's specifications shall be made according to Seller's RMA procedure within thirty (30) days of invoice/shipment date and may be replaced, repaired, or credited at GlobTek's option. All RMA claims reported more than thirty (30) days after the invoice/shipment date are not eligible for return, replacement or credit at subject to GlobTek's Terms and Conditions. GlobTek will not issue credit if the Product has been altered, repaired, or opened by persons other than those authorized by GlobTek, become defective due to acts of God or negligence, become defective due to being subjected to abnormal conditions during installation, application or maintenance or if warranty has expired. Acceptance of Buyer's debit will not be made until material has been received and evaluated by the GlobTek. To determine the "Root Cause of Failure", the product may be destroyed during evaluation. If this occurs all of the above Terms and Conditions will remain in effect. All freight costs for returns, both from customer back to GlobTek and GlobTek back to customer will not be borne by GlobTek. GlobTek requires all goods to be returned freight, duty, and taxes prepaid to the location provided in the RMA authorization notification and repaired or replaced goods will be provided on an EX WORKS return location. GlobTek shall not be responsible, under any circumstances, for any rework or modification fee's or costs not previously authorized in writing by GlobTek. If returned goods do not match the quantity or descriptions provided in the RMA application, any non conforming goods will not be qualified for repair, return, or replacement. Goods with illegible date code/serial # information may not be eligible for repair, return, replacement

PRICES/TAXES/TARIFFS:

1. Prices shall be as specified by Seller and shall be applicable for the period specified in GlobTek's quote. If no period is specified, prices shall be applicable for thirty (30) days. Notwithstanding the foregoing, prices shall be subject to increase in the event of an increase in GlobTek's costs or other circumstances beyond GlobTek's reasonable control. Prices are exclusive of taxes, impositions, tariffs, fees, and other charges, including, without limitation, sales, use, excise, value added, and ad valorem taxes, as well as tariffs of all types (including any tariffs imposed pursuant to any Section 301 Action by the United States Trade Representative) and similar taxes, fees, imposts, or charges of whatsoever kind, imposed now or in the future by any foreign or domestic governmental authority, international shipping charges, forwarding agent's and broker's fees, consular fees, document fees and import duties. If GlobTek shall be liable to collect and/or pay, or if the GlobTek shall pay, any of the foregoing, Buyer shall pay same to GlobTek in addition to the price of the Products.

<p>GlobTek, Inc. www.globtek.com 186 Veterans Drive, Northvale, NJ 07647 Tel. (201) 784-1000 Fax (201) 784-0111</p>	<p>Drawing Title: GT-46401-3612, ICT/ITE Power Supply, Efficiency Level: USA DOE Level VI / Eco-design Directive 2009/125/EC, (EU) 2019/1782, Case Color/Style: GlobTek Black, Wall Plug-in, Regulated Switchmode AC-DC Power Supply AC Adaptor, Input Rating: 100-240V~, 50-60 Hz, Interchangeable Blades, https://www.globtek.com/interchangeable-blades.php, Output Rating: 36.00W, 12.0V@3.0A, Pin Out: Center Positive (+V), symbol compliant with IEC 60417 symbol no. 5926, Output Configuration: 1330 mm, 16/2 Cond, UL 2468, Female Barrel 5.5 * 2.5 * 11mm with internal Spring Clip and Locking Notch or Equal, Ferrite: Core Size: 14.2*28.5*8.2, GlobTek Black, GT Cord # C17701, Blades/Input Cord: (Order Separately), Approvals:</p>
	<p>Model No. GT-46401-3612</p>
	<p>Part No./Ordering No. WR9QE3000LCP-N(R6B) Rev F</p>

TERMS OF PAYMENT:

1. Payment shall be net thirty (30) days from date of invoice or as otherwise specified by GlobTek. Buyer agrees to pay the entire net amount of each invoice from Seller pursuant to the terms of each such invoice without offset or deduction. Orders are subject to credit approval by GlobTek, which may in its sole discretion at any time change the terms of Buyer's credit, require payment in cash, bank wire transfer, or by official bank check and/or require payment of any or all amounts due or to become due for Buyer's order before shipment of any or any of the Products. If GlobTek believes in good faith that Buyer's ability to make payments may be impaired or if Buyer shall fail to pay any invoice when due, GlobTek may suspend delivery of any order or any remaining balance thereof until such payment is made or cancel any order or any remaining balance thereof, and Buyer shall remain liable to pay for any Products already shipped and all Products ordered by Buyer. Buyer agrees to submit such financial information from time to time as may be reasonably requested by GlobTek for the establishment and/or continuation of credit terms. Checks are accepted subject to collection and the date of collection shall be deemed the date of payment. Any check received from Buyer may be applied by GlobTek against any obligation owing from Buyer to GlobTek, regardless of any statement appearing on or referring to such check, without discharging Buyer's liability for any additional amounts owing from Buyer to GlobTek, and the acceptance by GlobTek of such check shall not constitute a waiver of GlobTek's right to pursue the collection of any remaining balance. Buyer shall pay interest on any invoice not paid when due according to the due date at the rate of eighteen (18%) percent annually or the highest rate allowable by law. If Buyer fails to make payment when due, GlobTek may pursue any legal or equitable remedies, in which event GlobTek shall be entitled to reimbursement for costs of collection and reasonable attorneys fees.

REFUSED OR DAMAGED SHIPMENTS:

1. All products returned to GlobTek due to refusal of acceptance by buyer, without GlobTek authorization, will be subject to minimum of 25% restocking charge* and buyer must pay return freight to GlobTek. Parts must be in original condition and packaging. Seller takes extra precautions to insure that shipments are made under the Highest Quality Standards. In the event a shipment is received in damaged condition, Buyer shall contact the carrier to submit claim, keep Products in original boxes pending carrier's inspection and place a replacement order with the Seller.
2. *Custom items and/or dedicated production lots are not returnable.

TECHNICAL ADVICE AND DATA:

1. Any technical advice offered or given in connection with the use of any goods is an accommodation to Buyer without charge and GlobTek shall have no responsibility or liability whatsoever for the content or use of such advice. Without GlobTek's prior written consent, Buyer shall not use, duplicate or disclose any technical data delivered or disclosed by GlobTek to Buyer for any purposes other than for installation, operation or maintenance of goods purchased by Buyer. Any use made of GlobTek classifications, whether it be ECCNs or any variation of Harmonized Tariff codes, is without recourse to GlobTek and at the user's risk. Export classifications are subject to change. If you export or re-export, your company, as the exporter of record, is responsible for determining the correct classification of any item at the time of export. Any export classification by GlobTek is for GlobTek's internal use only and shall not be construed as a representation or warranty regarding the proper export classification nor relied upon to make licensing determinations.

<p>GlobTek, Inc. www.globtek.com 186 Veterans Drive, Northvale, NJ 07647 Tel. (201) 784-1000 Fax (201) 784-0111</p>	<p>Drawing Title: GT-46401-3612, ICT/ITE Power Supply, Efficiency Level: USA DOE Level VI / Eco-design Directive 2009/125/EC, (EU) 2019/1782, Case Color/Style: GlobTek Black, Wall Plug-in, Regulated Switchmode AC-DC Power Supply AC Adaptor, Input Rating: 100-240V~, 50-60 Hz, Interchangeable Blades, https://www.globtek.com/interchangeable-blades.php, Output Rating: 36.00W, 12.0V@3.0A, Pin Out: Center Positive (+V), symbol compliant with IEC 60417 symbol no. 5926, Output Configuration: 1330 mm, 16/2 Cond, UL 2468, Female Barrel 5.5 * 2.5 * 11mm with internal Spring Clip and Locking Notch or Equal, Ferrite: Core Size: 14.2*28.5*8.2, GlobTek Black, GT Cord # C17701, Blades/Input Cord: (Order Separately), Approvals:</p>
	<p>Model No. GT-46401-3612</p>
	<p>Part No./Ordering No. WR9QE3000LCP-N(R6B) Rev F</p>

FORCE MAJEURE:

1. GlobTek shall not be liable for failure to fulfill the obligations herein or for delays in delivery due to causes beyond its reasonable control, including, but not limited to, acts of God, natural disasters, acts or omissions of other parties acts or omissions of civil or military authority, Government priorities, changes in law, material shortages, fire, strikes, floods, epidemics, quarantine restrictions, riots, war, acts of terrorism, delays in transportation or inability to obtain labor or materials through its regular sources. GlobTek's time for performance of any such obligation shall be extended for the time period of such delay or GlobTek may, at its option cancel any order or remaining part thereof without liability, advising in writing notice of such cancellation to Buyer.

LIMITATION OF LIABILITIES:

1. BUYER SHALL NOT IN ANY EVENT BE ENTITLED TO, AND SELLER SHALL NOT BE LIABLE FOR INDIRECT, SPECIAL, INCIDENTAL OR CONSEQUENTIAL DAMAGES OF ANY NATURE INCLUDING, WITHOUT LIMITATION BUSINESS INTERRUPTION COSTS, REMOVAL AND/OR REINSTALLATION COSTS, REPROCUREMENT COSTS, LOSS OF PROFIT OR REVENUE, LOSS OF DATA, PROMOTIONAL OR MANUFACTURING EXPENSES, OVERHEAD, INJURY TO REPUTATION OR LOSS OF CUSTOMERS, EVEN IF GLOBTEK HAS BEEN ADVISED OF THE POSSIBILITY OF SUCH DAMAGES. BUYER'S RECOVERY FROM SELLER FOR ANY CLAIM SHALL NOT EXCEED BUYER'S PURCHASE PRICE FOR THE PRODUCT GIVING RISE SUCH CLAIM IRRESPECTIVE OF THE NATURE OF THE CLAIM, WHETHER IN CONTRACT, TORT, WARRANTY OR OTHERWISE. GLOBTEK SHALL NOT BE LIABLE FOR AND BUYER SHALL INDEMNIFY, DEFEND AND HOLD GLOBTEK HARMLESS FROM ANY CLAIMS BASED ON GLOBTEK'S COMPLIANCE WITH BUYER'S DESIGNS, SPECIFICATIONS OR INSTRUCTIONS, OR MODIFICATION OF ANY PRODUCTS BY PARTIES OTHER THAN SELLER, OR USE IN COMBINATION WITH OTHER PRODUCTS. GLOBTEK INC. WILL NOT BE LIABLE FOR THE SAFETY AND PERFORMANCE OF THESE PRODUCTS IF UNAUTHORIZED USE, ACCESS AND/OR REPAIR. END USER SHOULD CONSULT APPLICABLE UL, CSA OR EN STANDARDS FOR PROPER INSTALLATION INSTRUCTIONS. GLOBTEK PRODUCTS ARE NOT AUTHORIZED FOR USE AS MISSION CRITICAL COMPONENTS IN LIFE SUPPORT, HAZARDOUS ENVIRONMENT, NUCLEAR OR AIRCRAFT APPLICATIONS WITHOUT PRIOR WRITTEN APPROVAL FROM THE CEO OF GLOBTEK INC. CONTENTS OF GLOBTEK SPECIFICATIONS ARE SUBJECT TO CHANGE WITHOUT PRIOR NOTICE.

<p>GlobTek, Inc. www.globtek.com 186 Veterans Drive, Northvale, NJ 07647 Tel. (201) 784-1000 Fax (201) 784-0111</p>	<p>Drawing Title: GT-46401-3612, ICT/ITE Power Supply, Efficiency Level: USA DOE Level VI / Eco-design Directive 2009/125/EC, (EU) 2019/1782, Case Color/Style: GlobTek Black, Wall Plug-in, Regulated Switchmode AC-DC Power Supply AC Adaptor, Input Rating: 100-240V~, 50-60 Hz, Interchangeable Blades, https://www.globtek.com/interchangeable-blades.php, Output Rating: 36.00W, 12.0V@3.0A, Pin Out: Center Positive (+V), symbol compliant with IEC 60417 symbol no. 5926, Output Configuration: 1330 mm, 16/2 Cond, UL 2468, Female Barrel 5.5 * 2.5 * 11mm with internal Spring Clip and Locking Notch or Equal, Ferrite: Core Size: 14.2*28.5*8.2, GlobTek Black, GT Cord # C17701, Blades/Input Cord: (Order Separately), Approvals:</p>
	<p>Model No. GT-46401-3612</p>
	<p>Part No./Ordering No. WR9QE3000LCP-N(R6B) Rev F</p>

GENERAL:

- As used herein, terms appearing in the singular shall include the plural and terms appearing in the plural shall include singular. No rights, duties, agreements or obligations hereunder may be assigned or transferred by either party, by operation of law, merger or otherwise, without the prior written consent of the other. Any attempted or purported assignment shall be void. Notwithstanding the foregoing, GlobTek's obligations under these Terms and Conditions may be performed by divisions, subsidiaries or affiliates of GlobTek. The obligations, rights, terms and conditions hereof shall be binding on the parties hereto and their respective successors and assigns. The waiver of any provision hereof or of any breach or default hereunder shall not be deemed a waiver of any other provision hereof or breach or default hereunder. Any provision hereof which is prohibited or unenforceable in any jurisdiction shall, as to such jurisdiction, be ineffective to the extent of such prohibition or unenforceability without invalidating the remaining provisions hereof in that jurisdiction or affecting the validity or enforceability of such provision in any other jurisdiction. These Terms and Conditions shall be governed by and construed in accordance with the laws of the State of New Jersey, United States, excluding any law or principle, which would apply the law of any other jurisdiction. The United Nations Convention on contracts for the International Sale of Goods shall not apply to these Terms.

LIMITED WARRANTIES:

<p>GlobTek, Inc. www.globtek.com 186 Veterans Drive, Northvale, NJ 07647 Tel. (201) 784-1000 Fax (201) 784-0111</p>	<p>Drawing Title: GT-46401-3612, ICT/ITE Power Supply, Efficiency Level: USA DOE Level VI / Eco-design Directive 2009/125/EC, (EU) 2019/1782, Case Color/Style: GlobTek Black, Wall Plug-in, Regulated Switchmode AC-DC Power Supply AC Adaptor, Input Rating: 100-240V~, 50-60 Hz, Interchangeable Blades, https://www.globtek.com/interchangeable-blades.php, Output Rating: 36.00W, 12.0V@3.0A, Pin Out: Center Positive (+V), symbol compliant with IEC 60417 symbol no. 5926, Output Configuration: 1330 mm, 16/2 Cond, UL 2468, Female Barrel 5.5 * 2.5 * 11mm with internal Spring Clip and Locking Notch or Equal, Ferrite: Core Size: 14.2*28.5*8.2, GlobTek Black, GT Cord # C17701, Blades/Input Cord: (Order Separately), Approvals:</p>
	<p>Model No. GT-46401-3612</p>
	<p>Part No./Ordering No. WR9QE3000LCP-N(R6B) Rev F</p>

1. GLOBTEK'S POWER SUPPLIES ARE BUILT WITH PRIDE BY PROFESSIONALS DEDICATED TO UNCOMPROMISING QUALITY AND RELIABILITY. YOUR COMPLETE SATISFACTION WITH OUR PRODUCTS IS OUR PARAMOUNT OBJECTIVE. IF GLOBTEK IS GIVEN NOTICE OF A DEFECT IN MATERIALS OR WORKMANSHIP OCCURRING WITHIN FIVE (5) YEARS FROM THE DATE OF SHIPMENT BY GLOBTEK, THEN GLOBTEK SHALL, AT ITS SOLE OPTION: 1) REPAIR OR REPLACE THE DEFECTIVE PART(S) OR PRODUCT(S) OR 2) REFUND THE ORIGINAL PURCHASE PRICE, BOTH SUBJECT TO THE FOLLOWING PROVISIONS OF THIS PARAGRAPH. THIS WARRANTY ONLY EXTENDS TO POWER SUPPLIES, ELECTRICAL ASSEMBLIES AND POWER CABLES MADE BY GLOBTEK. THIS WARRANTY DOES NOT EXTEND TO ANY AND ALL BATTERY CELLS, OR TO BRANDED CONNECTOR ITEMS, CUSTOMER SPECIFIED ITEMS FROM OTHER MANUFACTURERS, CUSTOMER SUPPLIED MATERIALS, OR DEFECTS RESULTING FROM CUSTOMER SUPPLIED MATERIALS. DEFECTS RESULTING FROM CUSTOMER SUPPLIED MATERIALS WILL NULLIFY THIS WARRANTY. THIS WARRANTY ALSO DOES NOT EXTEND TO PRODUCTS WHICH HAVE BEEN OPENED, ALTERED OR REPAIRED BY PERSONS OTHER THAN PERSONS AUTHORIZED BY THE MANUFACTURER OR TO PRODUCTS WHICH BECOME DEFECTIVE DUE TO ACTS OF GOD AND OTHER ACTS CONSTITUTING FORCE MAJEURE AS DEFINED IN SECTION 8 ABOVE, NEGLIGENCE OR THE FAILURE OF THE USER TO FULLY FOLLOW INSTRUCTIONS WITH RESPECT TO INSTALLATION, APPLICATION OR MAINTENANCE. THIS WARRANTY DOES NOT EXTEND TO PRODUCTS WHICH HAVE BEEN SUBJECT TO ABNORMAL USE, ABNORMAL CONDITIONS, IMPROPER STORAGE, SPILLAGE OF LIQUIDS, MISUSE, NEGLIGENCE, EXPOSURE TO CLEANING AGENTS NOT RECOMMENDED BY THE MANUFACTURER, OR OTHER ACTS WHICH ARE NOT THE FAULT OF GLOBTEK. THIS WARRANTY DOES NOT COVER ORDINARY WEAR AND TEAR, DEFECTS IN APPEARANCE, COSMETIC, DECORATIVE OR STRUCTURAL ITEMS OR NON-OPERATIVE PARTS. WITH REGARD TO BATTERY CELLS, OR TO BRANDED CONNECTOR ITEMS, CUSTOMER SPECIFIED ITEMS FROM OTHER MANUFACTURERS, AND CUSTOMER SUPPLIED MATERIALS, THE BUYER IS REFERRED TO THE MANUFACTURER'S WARRANTY, IF ANY. FOR RECHARGEABLE BATTERY PACK PRODUCTS, ANY CLAIM FOR WARRANTY MUST BE SUPPORTED BY AUDITABLE EVIDENCE OF PROPER USE, HANDLING, AND MAINTENANCE ACCORDING TO GLOBTEK AND CELL MANUFACTURER SPECIFICATIONS. THIS WARRANTY IS NOT A WARRANTY OF FUTURE PERFORMANCE. IN ORDER TO EXERCISE THE BUYER'S REMEDY FOR BREACH OF THIS LIMITED WARRANTY, GLOBTEK MUST BE GIVEN WRITTEN NOTICE OF A DEFECT IN MATERIALS OR WORKMANSHIP WITHIN FIVE (5) YEARS OF THE DATE OF SHIPMENT. FURTHER, GLOBTEK'S INSPECTION ESTABLISHES THE EXISTENCE OF A DEFECT. PACKAGING, FREIGHT, INSURANCE AND OTHER CHARGES INCURRED IN RETURNING THE DEFECTIVE PRODUCTS TO WILL BE PAID BY THE BUYER. IF THE BUYER FAILS TO FULLY COMPLY WITH THE FOREGOING, BUYER SHALL NOT BE ENTITLED TO ANY ALLOWANCE OR CLAIM WITH RESPECT TO SUCH PRODUCT. THE BUYER AGREES THAT NO OTHER REMEDY (INCLUDING, BUT NOT LIMITED TO, INCIDENTAL OR CONSEQUENTIAL DAMAGES FOR LOST PROFITS, LOST SALES, INJURY TO PERSON OR PROPERTY OR ANY OTHER INCIDENTAL OR CONSEQUENTIAL LOSSES) SHALL BE AVAILABLE TO THE BUYER.

2. EXCEPT FOR THE FOREGOING EXPRESS LIMITED WARRANTY, GLOBTEK MAKES NO WARRANTY, EXPRESS OR IMPLIED, INCLUDING, BUT NOT LIMITED TO, THE WARRANTIES OF MERCHANTABILITY AND FITNESS FOR A PARTICULAR PURPOSE, ALL OF WHICH IMPLIED WARRANTIES ARE HEREBY SPECIFICALLY DISCLAIMED.