

- Features :
 - DC/DC buck-boost converter
 - Constant current output: 300mA to 600mA
 - Wide input voltage: 9 ~ 36VDC
 - Wide output LED string voltage: 2 ~ 40VDC
 - High efficiency up to 91%
 - Comply with BS EN/EN55015 and FCC part15
 - Built-in PWM and remote ON/OFF control
 - Protections: Short circuit / Over temperature
 - Cooling by free air convection
 - Fully encapsulated with IP67 level
 - Compact size
 - High reliability
 - Suitable for driving illumination LED
 - 3 years warranty

■ GTIN CODE

MW Search: <https://www.meanwell.com/serviceGTIN.aspx>



LDB-350L Blank : pin style
 W : wire style

SPECIFICATION

ORDER NO.	LDB-300L <input type="checkbox"/>	LDB-350L <input type="checkbox"/>	LDB-500L <input type="checkbox"/>	LDB-600L <input type="checkbox"/>			
OUTPUT	CURRENT RANGE	300mA	350mA	500mA	600mA		
	VOLTAGE RANGE <small>Note.4</small>	2 ~ 40VDC	2 ~ 40VDC	2 ~ 32VDC	2 ~ 30VDC		
	CURRENT ACCURACY (Typ.)	±5%					
	RIPPLE & NOISE(max.) <small>Note.2</small>	150mVp-p	150mVp-p	150mVp-p	200mVp-p		
	SWITCHING FREQUENCY	1000KHz					
NO LOAD OUTPUT VOLTAGE		75VDC					
INPUT	VOLTAGE RANGE <small>Note.4</small>	9 ~ 36VDC	9 ~ 36VDC	9 ~ 30VDC	9 ~ 28VDC		
	EFFICIENCY (max.)	12VDC	86%	89%	87%	82%	
		24VDC	90%	91%	89%	88%	
	DC CURRENT	Full load	12VDC	930mA	1100mA	1590mA	2000mA
			24VDC	450mA	520mA	790mA	930mA
No load		2mA (Vin 24VDC)					
FILTER		Capacitor					
PWM DIMMING & ON/OFF CONTROL	REMOTE ON/OFF	Leave open if not use Power ON with dimming: DIM ~ -Vin >2 ~ 10VDC or open circuit Power OFF : DIM ~ -Vin < 0.5VDC or short					
	PWM FREQUENCY	100 ~ 1KHz					
	MAX. PWM SIGNAL CURRENT	1mA					
PROTECTION	SHORT CIRCUIT	Regulated at rated output current Protection type : Can be continued, recovers automatically after fault condition is removed					
	OVER TEMPERATURE	Tj 145°C typically(IC1) detect on main control IC Protection type : Shut down, recovers automatically after temperature goes down					
ENVIRONMENT	WORKING TEMP.	-40 ~ + 70°C (Refer to derating curve)					
	WORKING HUMIDITY	20% ~ 90% RH non-condensing					
	STORAGE TEMP., HUMIDITY	-55 ~ +125°C, 10 ~ 95% RH					
	TEMP. COEFFICIENT	±0.03% / °C					
	VIBRATION	10 ~ 500Hz, 2G 10min./1 cycle, period for 60min. each along X, Y, Z axes					
OPERATING CASE TEMP. (max.)		115°C					
EMC	SAFETY STANDARDS	EAC TP TC 020/2011 approved					
	EMC EMISSION	Compliance to BS EN/EN55015, FCC part 15 class B, EAC TP TC 020					
	EMC IMMUNITY	Compliance to BS EN/EN61000-4-2,3,4,6,8, light industry level, criteria A, EAC TP TC 020					
OTHERS	MTBF	350Khrs min. MIL-HDBK-217F (25°C)					
	DIMENSION	31.8*20.3*12.2mm or 1.25**0.8**0.48" inch (L*W*H)					
	WEIGHT	LDB-L:15.6g(15pcs/Tube) ; LDB-LW:18g(20pcs/Box), Please order Base on MPQ					
	POTTING MATERIAL	Expoxy(UL94-V0)					
NOTE	1.All parameters are specified at normal input(24VDC), rated load, 25°C 70% RH ambient. 2.Ripple & noise are measured at 20MHz by using a 12" twisted pair terminated with a 0.1uf capacitor. 3.The output of LDB-L should not be connected to the input of the same unit or output from other sources. 4. If input voltage is 36V then the output voltage operating range had better <38V.						

Mechanical Specification

Blank type(LDB – _L):

Unit: mm (inch)

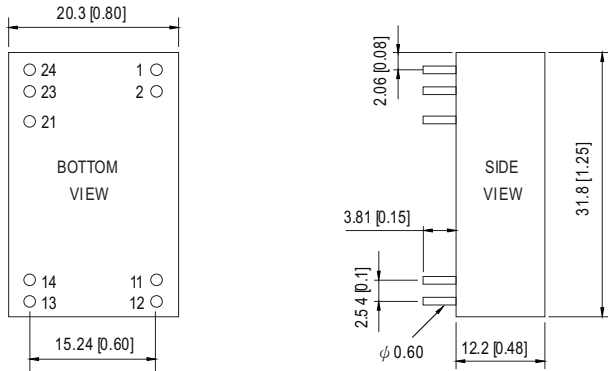

NOTE: Pin tolerance ± 0.05 mm

W type(LDB – _LW):

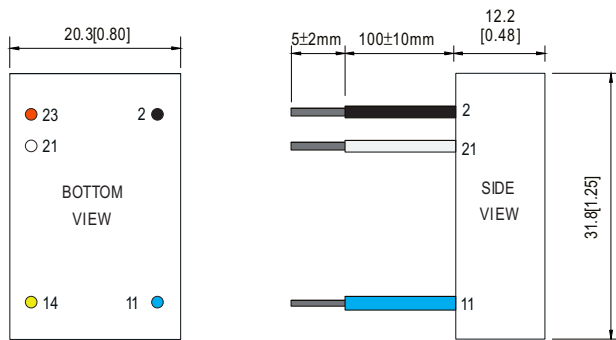

NOTE: All wires UL3385 22AWG

Pin Configuration

Pin No.		Comment
1,2	-Vin	Don't connect to -Vout
11,12	-Vout	LED - Connection
13,14	+Vout	LED + Connection
21	PWM DIM	ON/OFF and PWM Dimming (Leave open if not used)
23,24	+Vin	DC Supply

Pin No.		Comment
2	-Vin (Black)	Don't connect to -Vout
11	-Vout (Blue)	LED - Connection
14	+Vout (Yellow)	LED + Connection
21	PWM DIM (White)	ON/OFF and PWM Dimming (Leave open if not used)
23	+Vin (Red)	DC Supply

Derating Curve

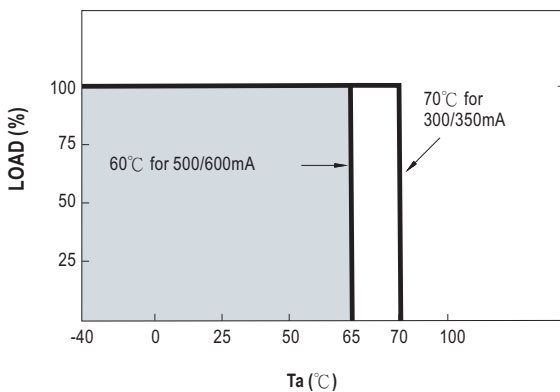

■ Safe Operating Area

OUTPUT CURRENT 300mA

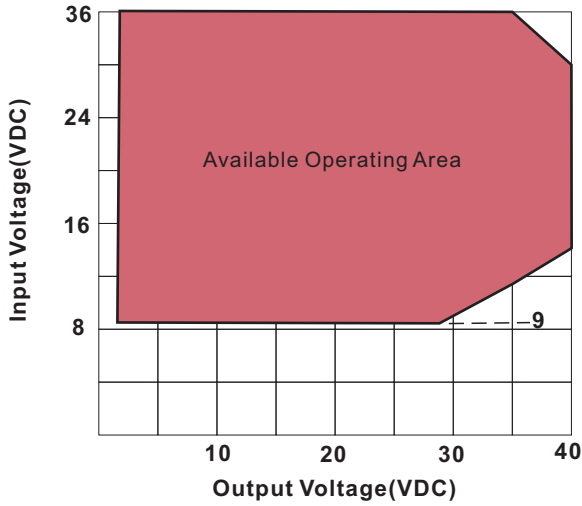

V_{in} 9V up to V_{out}=27V
 V_{in} 12V up to V_{out}=36V

OUTPUT CURRENT 350mA

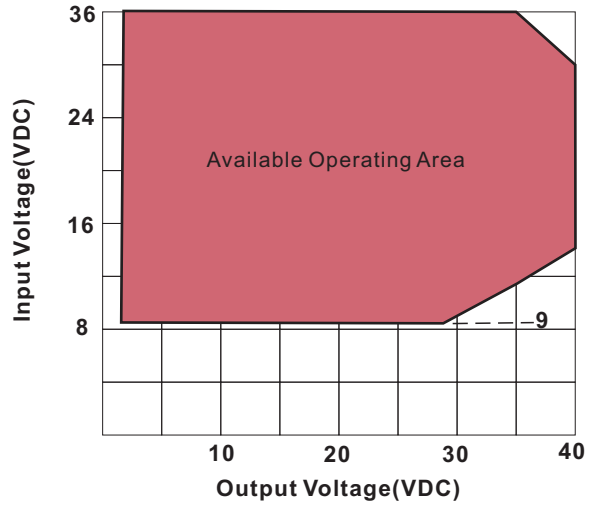

V_{in} 9V up to V_{out}=27V
 V_{in} 12V up to V_{out}=36V

OUTPUT CURRENT 500mA

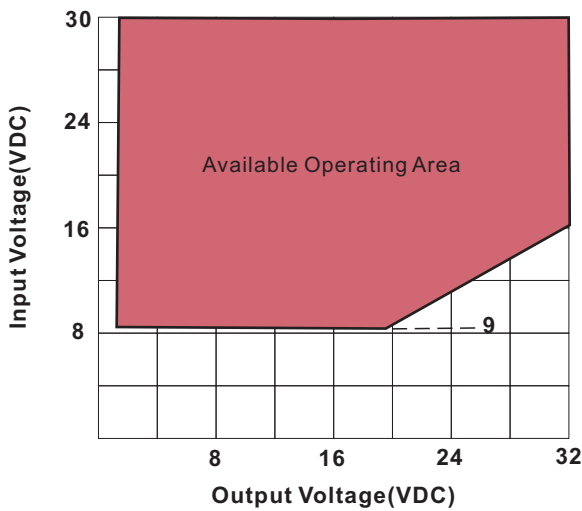

V_{in} 9V up to V_{out}=20V
 V_{in} 12V up to V_{out}=24V
 V_{in} 16V up to V_{out}=32V

OUTPUT CURRENT 600mA

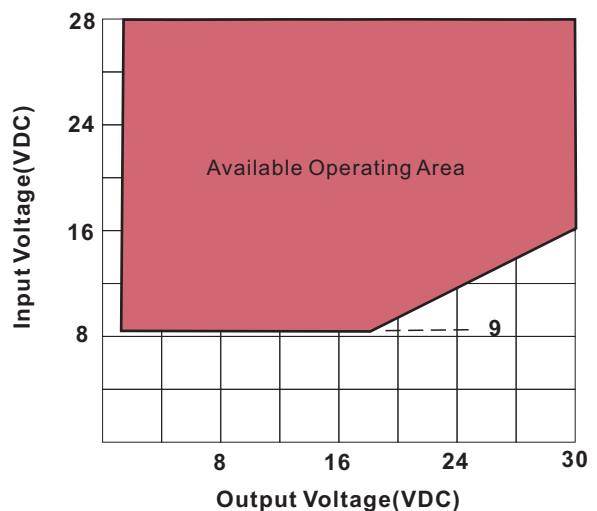

V_{in} 9V up to V_{out}=18V
 V_{in} 12V up to V_{out}=24V
 V_{in} 16V up to V_{out}=30V

■ PWM Dimming Control

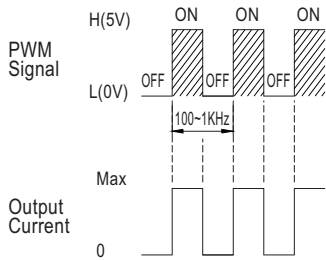

© During PWM dimming operation, the output current will change to PWM style.

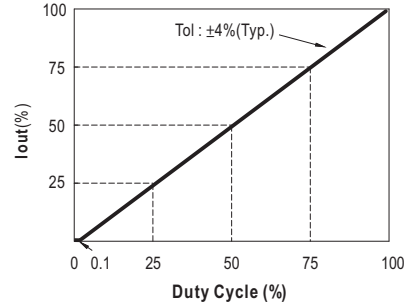

■ Standard Application

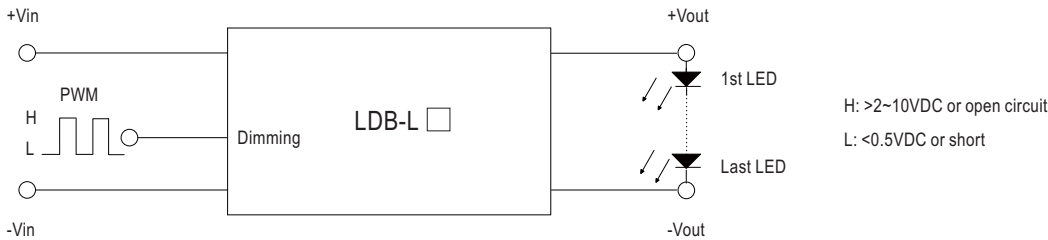

■ Efficiency VS Output Voltage(Number of LEDs)

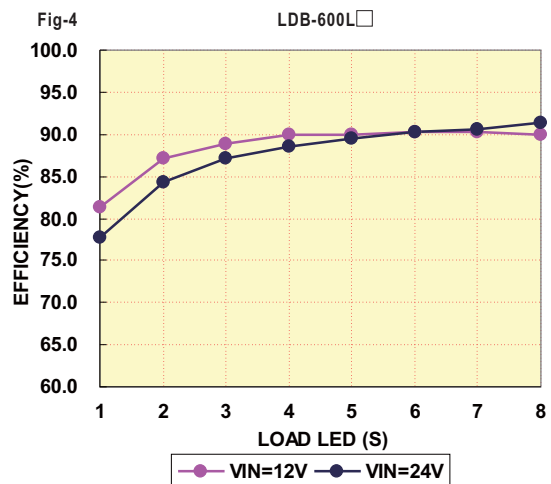
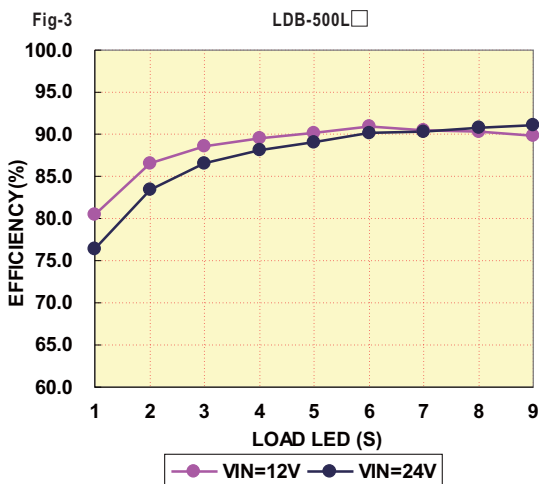
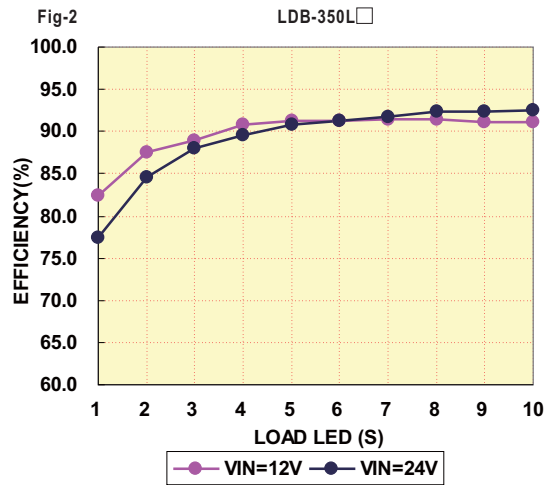
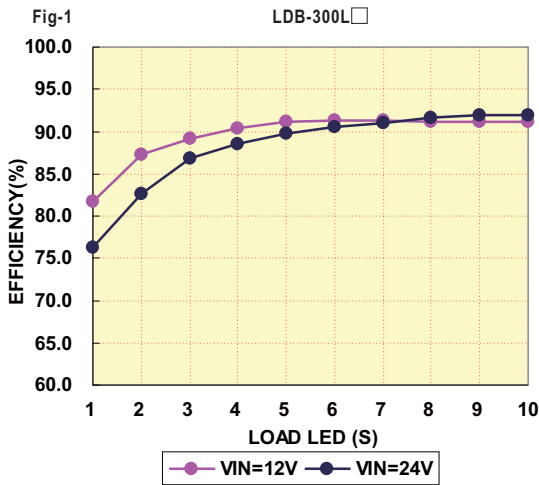

■ Packing

Standard Tube Packing	LDB-L			
	MPQ Per Tube (PCS)	One Tube G.W.	Max. Q'TY/ Carton(PCS)	One Carton G.W.
<p>Unit : mm</p> <p>Product</p> <p>Tube Plugs</p> <p>520</p> <p>24</p> <p>21.3</p> <p>8.472</p> <p>Tube pattern</p>	15	260g	750	13.8Kg
<p>Unit : mm</p> <p>2 pcs inside</p> <p>Product</p> <p>Box</p> <p>220</p> <p>45</p> <p>195</p> <p>Antistatic Foam</p> <th colspan="4">LDB-LW</th>	LDB-LW			
	MPQ (Box)	One Box G.W.	Max. Q'TY/ Carton(PCS)	One Carton G.W.
	20	440g	240	6.08Kg

Standard Tube Packing

Unit : mm

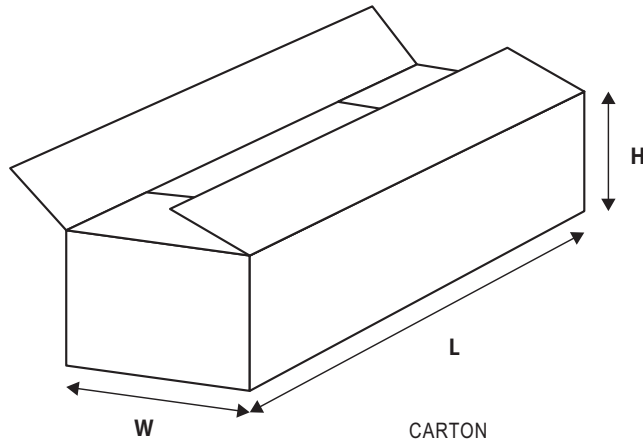

CARTON
L620 x W230 x H230

■ **Installation Manual**

Please refer to : <http://www.meanwell.com/manual.html>