

# 5 mm Square Surface Mount Miniature Trimmers Single-Turn Cermet Sealed



## FEATURES

- 0.25 W at 70 °C
- For through hole version see T53Y series
- Wide ohmic range (10 Ω to 1 MΩ)
- Small size for optimum packaging density
- Tests according to CECC 41000 or IEC 60393-1
- Material categorization: for definitions of compliance please see [www.vishay.com/doc?99912](http://www.vishay.com/doc?99912)



**RoHS**  
COMPLIANT

## LINKS TO ADDITIONAL RESOURCES



The TS53 trimming potentiometer has been designed for surface mount applications and offers volumetric efficiency (5 mm x 5 mm x 2.7 mm) with high performance and stability.

The TS53 design is suitable for both manual or automatic operation, and can withstand wave, and reflow soldering techniques.

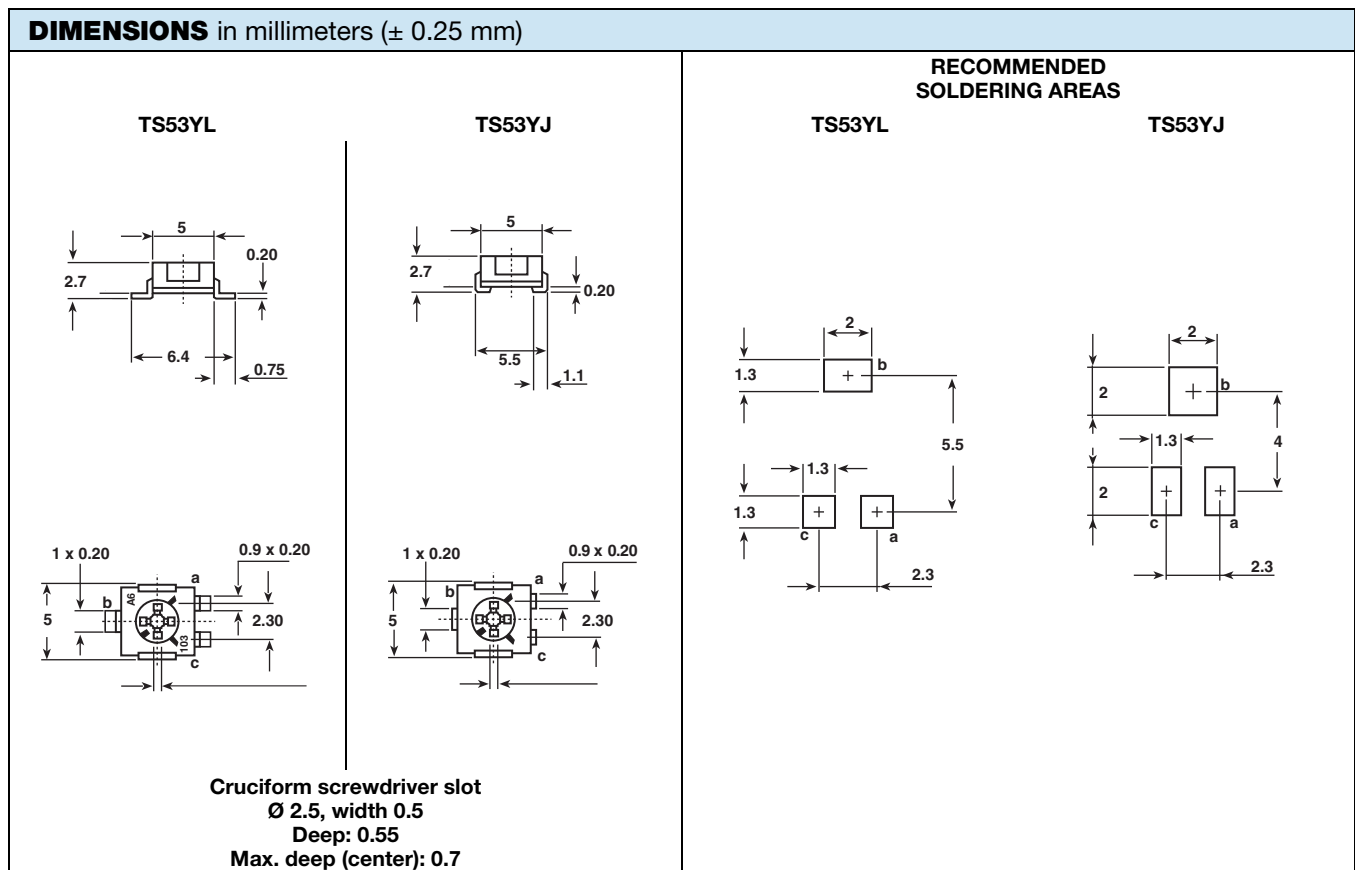

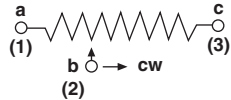
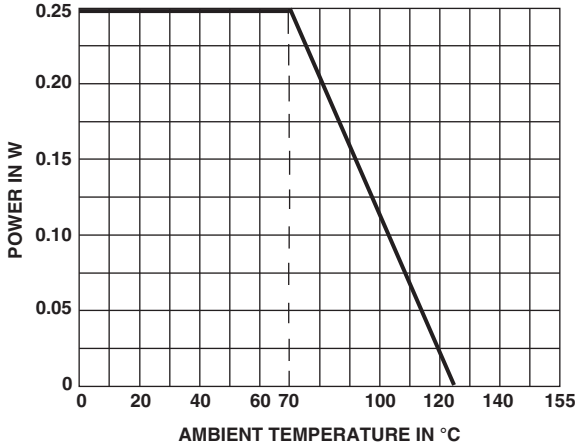
ELECTRICAL SPECIFICATIONS	
Resistive element	Cermet
Electrical travel	220° ± 15°
Resistance range	10 Ω to 1 MΩ
Standard series	1 - 2 - 5
Tolerance standard	± 20 %
Circuit diagram	
Power rating	linear 0.25 W at + 70 °C 
Temperature coefficient	See Standard Resistance Element Data table
Limiting element voltage (linear law)	200 V
Contact resistance variation (typical)	1 % or 3 Ω
End resistance (typical)	0.1 % or 3 Ω
Dielectric strength (RMS)	1000 V
Insulation resistance	1 GΩ

MECHANICAL SPECIFICATIONS	
Mechanical travel	270 ° ± 10°
Operating torque (max. Ncm)	1.5
End stop torque (max. Ncm)	3.5
Unit weight (max. g)	0.15
Terminals	Pure Sn (e3)

ENVIRONMENTAL SPECIFICATIONS	
Temperature range	-55 °C to +125 °C
Climatic category	55 / 125 / 56
Sealing	Sealed container IP67
MSL level	4

SOLDERING RECOMMENDATIONS	
Recommended reflow profile 2, see Application Note <a href="http://www.vishay.com/doc?52029">www.vishay.com/doc?52029</a>	
<b>Caution</b> Reflow soldering must be done within 72 h while stored under a max. temperature of 30 °C, 60 % RH after opening the dry pack envelope.	



RECOMMENDED METHOD OF STORAGE

Dry box storage is recommended as soon as the hermetic bag has been opened to prevent moisture absorption. The following conditions should be observed, if dry boxes are not available:

- Storage temperature 10 °C to 30 °C
- Storage humidity ≤ 60 % RH max.

After more than 72 h under these conditions, moisture content will be too high for reflow soldering.

In case of moisture absorption, the devices will recover to the former condition by drying under the following condition:

192 h at 40 °C + 5 °C/- 0 °C and < 5 % RH (dry air/nitrogen) or

96 h at 60 °C + 5 °C and < 5 % RH for all device containers (not suitable for reel) or

24 h at 125 °C + 5 °C (not suitable for reel)

PERFORMANCES

TESTS	CONDITIONS	TYPICAL VALUES AND DRIFTS		
		$\Delta R_T/R_T$ (%)	$\Delta R_{1-2}/R_{1-2}$ (%)	OTHER
Electrical endurance	1000 h at rated power 90'/30' - ambient temp. 70 °C	± 2 %	± 3 %	Contact resistance variation: $\Delta R < 1 \% R_n$
Climatic sequence	Phase A dry heat 125 °C Phase B damp heat Phase C cold -55 °C Phase D damp heat 5 cycles	± 2 %	± 3 %	
Damp heat steady state	Temperature 40 °C - RH 93 % 56 days	± 2 %	± 3 %	Dielectric strength: 1000 V <sub>RMS</sub> Insulation resistance: > 10 <sup>4</sup> MΩ
Charge of temperature	-55 °C to +125 °C - 5 cycles	± 1 %		$\Delta V_{1-2}/V_{1-3} \leq \pm 2 \%$
Mechanical endurance	100 cycles - rated power	± (3 % + 5 Ω)		
Shock	50 g - 11 ms 3 successive shocks in 3 directions	± 1 %		$\Delta V_{1-2}/V_{1-3} \leq \pm 1 \%$
Vibration	10 Hz to 55 Hz 0.75 mm or 10 g - 6 h	± 1 %		$\Delta V_{1-2}/V_{1-3} \leq \pm 1 \%$

Note

- Nothing stated herein shall be construed as a guarantee of quality or durability.

STANDARD RESISTANCE ELEMENT DATA

STANDARD RESISTANCE VALUES	LINEAR LAW			TYPICAL TCR -55 °C +125 °C ppm/°C
	MAX. POWER AT 70 °C	MAX. WORKING VOLTAGE	MAX. CURRENT THROUGH ELEMENT	
Ω	W	V	mA	
10	0.25	1.58	158	± 100
20	0.25	2.24	112	
50	0.25	3.54	71	
100	0.25	5.00	50	
200	0.25	7.07	35	
500	0.25	11.2	22	
1K	0.25	15.8	16	
2K	0.25	22.4	11	
5K	0.25	35.4	7	
10K	0.25	50.0	5	
20K	0.25	70.7	3.5	
50K	0.25	112	2.2	
100K	0.25	158	1.6	
200K	0.20	200	1.0	
500K	0.08	200	0.4	
1M	0.04	200	0.2	

**MARKING**

Vishay trademark, ohmic value, manufacturing date

The ohmic value is indicated by a 3 figure code, the first two are significant figures, the third one is the multiplier.

Example: 100 = 10 Ω

101 = 100 Ω

102 = 1000 Ω

503 = 50 000 Ω

**PACKAGING**

On tape and reel of 500 pieces, code R10 (TR500) and 2000 pieces, code R20 (TR2000)

**R10**

3 slots - width 2 mm, each 120°

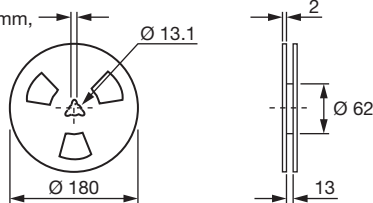

**R20**

3 slots - width 2 mm, each 120°

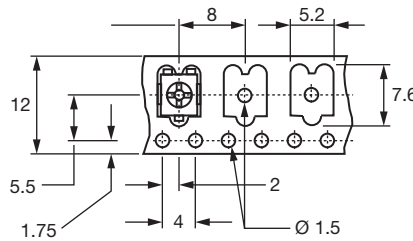
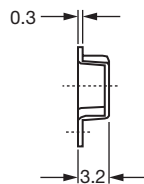
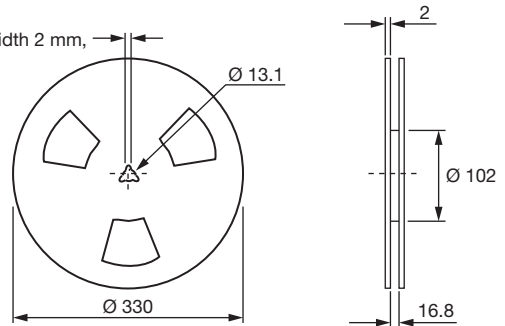

Cover tape panel strength specifications EIA 481 A and CEI 60286-3.

**DRYPACK**

Devices are packed in moisture barrier bags to prevent the products from moisture absorption during transportation and storage. Each bag contains a desiccant.

**ORDERING INFORMATION (part number)**

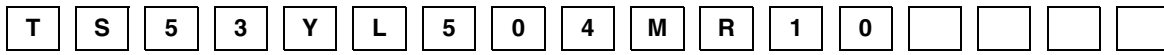

MODEL	STYLE	OHMIC VALUE	TOLERANCE	PACKAGING	SPECIAL NUMBER
TS53	YL YJ	From 10 Ω to 1 MΩ 504 = 500 kΩ	M = 20 %	R10 = reel 500 pieces On request R20 = reel 2000 pieces	(If applicable) Given by Vishay for custom design



DESCRIPTION (for information only)						
TS53	YL	500K	20 %		TR	e3
MODEL	STYLE	VALUE	TOLERANCE	SPECIAL	PACKAGING	LEAD (Pb)-FREE

RELATED DOCUMENTS	
<b>APPLICATION NOTES</b>	
Potentiometers and Trimmers	<a href="http://www.vishay.com/doc?51001">www.vishay.com/doc?51001</a>
Guidelines for Vishay Sfernice Resistive and Inductive Components	<a href="http://www.vishay.com/doc?52029">www.vishay.com/doc?52029</a>
Selector guide	<a href="http://www.vishay.com/doc?49286">www.vishay.com/doc?49286</a>

ACCESSORIES	
Screwdrivers (to order separately)	<a href="http://www.vishay.com/doc?57015">www.vishay.com/doc?57015</a>



## **Disclaimer**

ALL PRODUCT, PRODUCT SPECIFICATIONS AND DATA ARE SUBJECT TO CHANGE WITHOUT NOTICE TO IMPROVE RELIABILITY, FUNCTION OR DESIGN OR OTHERWISE.

Vishay Intertechnology, Inc., its affiliates, agents, and employees, and all persons acting on its or their behalf (collectively, "Vishay"), disclaim any and all liability for any errors, inaccuracies or incompleteness contained in any datasheet or in any other disclosure relating to any product.

Vishay makes no warranty, representation or guarantee regarding the suitability of the products for any particular purpose or the continuing production of any product. To the maximum extent permitted by applicable law, Vishay disclaims (i) any and all liability arising out of the application or use of any product, (ii) any and all liability, including without limitation special, consequential or incidental damages, and (iii) any and all implied warranties, including warranties of fitness for particular purpose, non-infringement and merchantability.

Statements regarding the suitability of products for certain types of applications are based on Vishay's knowledge of typical requirements that are often placed on Vishay products in generic applications. Such statements are not binding statements about the suitability of products for a particular application. It is the customer's responsibility to validate that a particular product with the properties described in the product specification is suitable for use in a particular application. Parameters provided in datasheets and / or specifications may vary in different applications and performance may vary over time. All operating parameters, including typical parameters, must be validated for each customer application by the customer's technical experts. Product specifications do not expand or otherwise modify Vishay's terms and conditions of purchase, including but not limited to the warranty expressed therein.

Hyperlinks included in this datasheet may direct users to third-party websites. These links are provided as a convenience and for informational purposes only. Inclusion of these hyperlinks does not constitute an endorsement or an approval by Vishay of any of the products, services or opinions of the corporation, organization or individual associated with the third-party website. Vishay disclaims any and all liability and bears no responsibility for the accuracy, legality or content of the third-party website or for that of subsequent links.

Vishay products are not designed for use in life-saving or life-sustaining applications or any application in which the failure of the Vishay product could result in personal injury or death unless specifically qualified in writing by Vishay. Customers using or selling Vishay products not expressly indicated for use in such applications do so at their own risk. Please contact authorized Vishay personnel to obtain written terms and conditions regarding products designed for such applications.

No license, express or implied, by estoppel or otherwise, to any intellectual property rights is granted by this document or by any conduct of Vishay. Product names and markings noted herein may be trademarks of their respective owners.