

Industrial Rotary Position Sensor Bushings Mount Type, Conductive Plastic

FEATURES

- Fully sealed for high immunity to environmental damage
- Excellent temperature stability
- Rotational life exceeds 2 million revolutions
- Low cost and wide range of options
- Stainless steel shaft
- Shock to 30 g vibration to 15 g at 10 Hz to 2000 Hz

QUICK REFERENCE DATA

Sensor type	ROTATIONAL, conductive plastic
Output type	Output by turrets
Market appliance	Industrial
Dimensions	15.81 mm x 17.46 mm



ELECTRICAL SPECIFICATIONS

PARAMETER	
Standard resistance	1 kΩ to 100 kΩ
Capability range	200 kΩ
Resistance tolerance	± 20 %
Linearity	± 2 %
Power rating	1.0 W at 85 °C
Electrical travel	240° ± 4°
Dielectric withstanding	500 V _{RMS} at 60 Hz minimum
Output smoothness	0.2 % maximum

MECHANICAL SPECIFICATIONS

PARAMETER	
Bearing type	Sleeve
Mechanical rotation	250° ± 2°
Stop strength	10 in - lb minimum, 11.5 kg/cm
Starting torque	3.0 o.z - in maximum, 216 g/cm
Running torque	3.0 oz. - in maximum, 216 g/cm

ORDERING INFORMATION/DESCRIPTION

657	B	F	0			50 kΩ	B10
MODEL	STYLE	SHAFT OPTIONS	SHAFT BUSHING OPTIONS			TOTAL RESISTANCE	PACKAGING
	B : Bushing	R - Round F - Flatted	 Shaft length 0 - 0.875" FMS 1 - 0.625" FMS 2 - 1.000" FMS 3 - 1.250" FMS	 Bushing length 0.375" FMS 0.250" FMS 0.500" FMS 0.750" FMS	 Flat 0.440" 0.315" 0.440" 0.440"		Box of 10 pieces

SAP PART NUMBERING GUIDELINES

657B	R	1	103	BO10
MODEL	END SHAFT	SHAFT AND BUSHING OPTIONS	OHMIC VALUE	PACKAGING
	R : Round	(see above)		

DIMENSIONS in inches (millimeters)

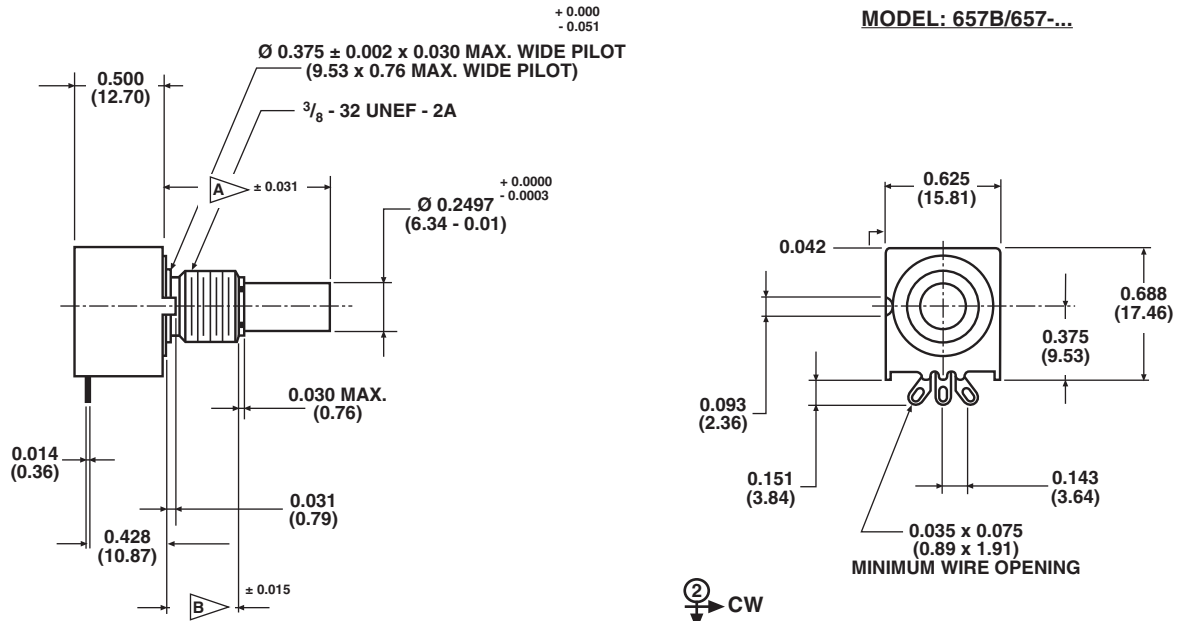

MODEL: 657B/657-...

DECIMALS: XX ± 0.01 INCHES (± 0.25 mm)
XX ± 0.005 INCHES (± 0.13 mm) ANGLES: ± 2°

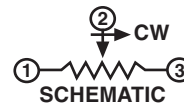

SHAFT FLAT AND PHASING DIAGRAM

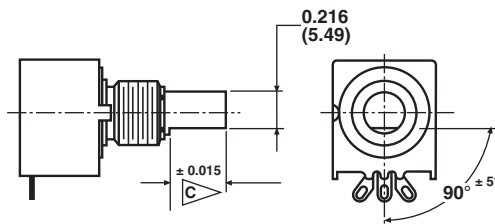

WITH SHAFT FLAT POSITIONED AS SHOWN, OUTPUT RATIO
TO BE e/E = 0.50 ± 0.02

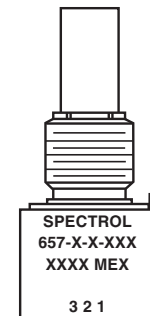

STANDARD RESISTANCE VALUES

CODE	RESISTANCE (Ω)
102	1K
202	2K
502	5K
103	10K
203	20K
503	50K
104	100K

MATERIAL SPECIFICATIONS

Shaft	Stainless steel
Bushing	Nickel plated brass
Housing	Thermoplastic
Element	Conductive plastic on alumina substrate

ENVIRONMENTAL SPECIFICATIONS

Rotational life	2 million revolutions
Vibration	15 g at 10 Hz to 2000 Hz
Operating temperature	-40 °C to +125 °C
Storage temperature	-55 °C to +150 °C
Temperature coefficient	± 600 ppm/°C
Shock	30 g
Resistant to solder heat	350 °C for 5 s
Moisture resistance IP rating	Sealed construction IP67* application to provide protection for wiring terminals

Note

- Nothing stated herein shall be construed as a guarantee of quality or durability.

MARKING

Unit identification	Vishay Spectrol, part number, data code, country of origin and terminal designation. Example of a marking for a standard part: 657-2-0-102
---------------------	--



Disclaimer

ALL PRODUCT, PRODUCT SPECIFICATIONS AND DATA ARE SUBJECT TO CHANGE WITHOUT NOTICE TO IMPROVE RELIABILITY, FUNCTION OR DESIGN OR OTHERWISE.

Vishay Intertechnology, Inc., its affiliates, agents, and employees, and all persons acting on its or their behalf (collectively, "Vishay"), disclaim any and all liability for any errors, inaccuracies or incompleteness contained in any datasheet or in any other disclosure relating to any product.

Vishay makes no warranty, representation or guarantee regarding the suitability of the products for any particular purpose or the continuing production of any product. To the maximum extent permitted by applicable law, Vishay disclaims (i) any and all liability arising out of the application or use of any product, (ii) any and all liability, including without limitation special, consequential or incidental damages, and (iii) any and all implied warranties, including warranties of fitness for particular purpose, non-infringement and merchantability.

Statements regarding the suitability of products for certain types of applications are based on Vishay's knowledge of typical requirements that are often placed on Vishay products in generic applications. Such statements are not binding statements about the suitability of products for a particular application. It is the customer's responsibility to validate that a particular product with the properties described in the product specification is suitable for use in a particular application. Parameters provided in datasheets and / or specifications may vary in different applications and performance may vary over time. All operating parameters, including typical parameters, must be validated for each customer application by the customer's technical experts. Product specifications do not expand or otherwise modify Vishay's terms and conditions of purchase, including but not limited to the warranty expressed therein.

Hyperlinks included in this datasheet may direct users to third-party websites. These links are provided as a convenience and for informational purposes only. Inclusion of these hyperlinks does not constitute an endorsement or an approval by Vishay of any of the products, services or opinions of the corporation, organization or individual associated with the third-party website. Vishay disclaims any and all liability and bears no responsibility for the accuracy, legality or content of the third-party website or for that of subsequent links.

Vishay products are not designed for use in life-saving or life-sustaining applications or any application in which the failure of the Vishay product could result in personal injury or death unless specifically qualified in writing by Vishay. Customers using or selling Vishay products not expressly indicated for use in such applications do so at their own risk. Please contact authorized Vishay personnel to obtain written terms and conditions regarding products designed for such applications.

No license, express or implied, by estoppel or otherwise, to any intellectual property rights is granted by this document or by any conduct of Vishay. Product names and markings noted herein may be trademarks of their respective owners.