

BROOKE-G2-S

~20° spot beam compatible with LEDiL HEKLA.

SPECIFICATION:

Dimensions	Ø 45.0 mm
Height	18.9 mm
Fastening	socket
ROHS compliant	yes ⓘ

MATERIALS:

Component	Type	Material	Colour	Finish	Coating
BROOKE-G2-S	Reflector	PC	metal		HMDS



ORDERING INFORMATION:

Component	Qty in box	MOQ	MPQ	Box weight (kg)
F14738_BROOKE-G2-S » Box size: 480 x 280 x 300 mm	720	45	45	4.8

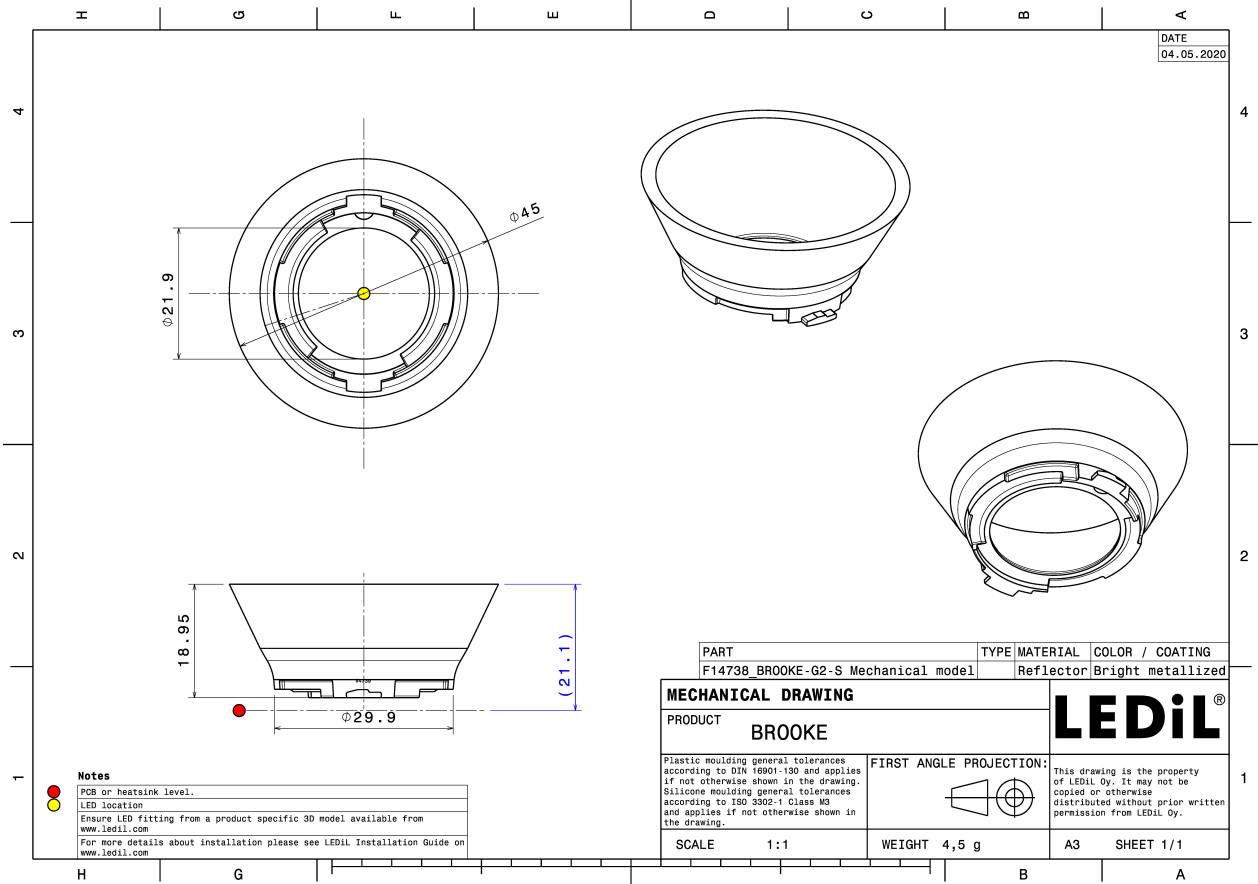

See also our general installation guide: www.ledil.com/installation_guide

OPTICAL RESULTS (MEASURED):

bridgelux

LED V10 Gen7
 FWHM / FWTM 22.0° / 74.0°
 Efficiency 88 %
 Peak intensity 2.7 cd/lm
 LEDs/each optic 1
 Light colour/type White

Required components:

F15255_HEKLA-SOCKET-C
 C14658_BARBARA-RZ-LENS

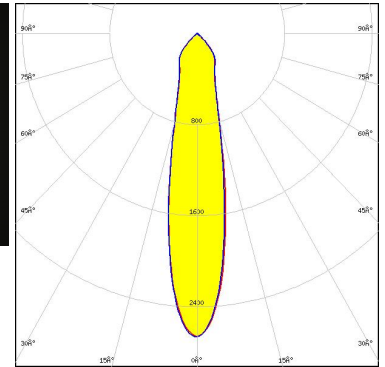

Light distribution files

bridgelux

LED V4 HD Gen 7
 FWHM / FWTM 8.8° / 16.5°
 Efficiency 94 %
 Peak intensity 12.9 cd/lm
 LEDs/each optic 1
 Light colour/type White

Required components:

F15253_HEKLA-SOCKET-A

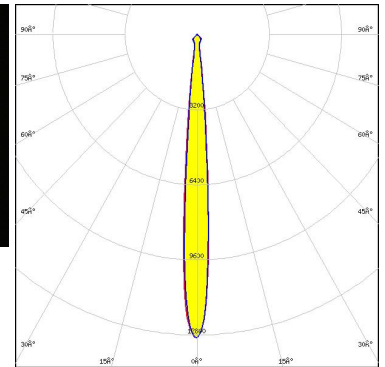
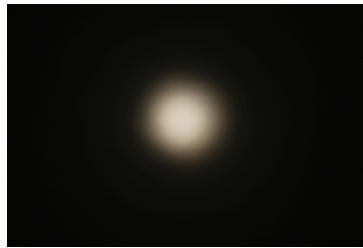

Light distribution files

bridgelux

LED V4 HD Gen 7
 FWHM / FWTM 13.0° / 32.0°
 Efficiency 90 %
 Peak intensity 5.4 cd/lm
 LEDs/each optic 1
 Light colour/type White

Required components:

F15253_HEKLA-SOCKET-A
 C14658_BARBARA-RZ-LENS

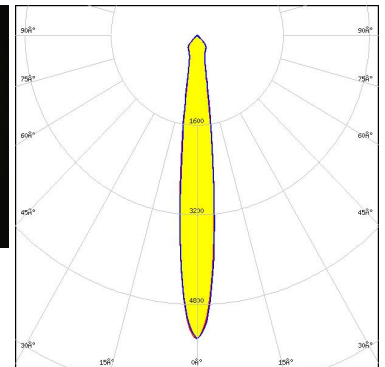
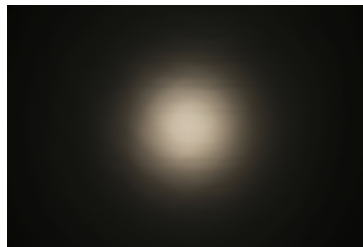

Light distribution files

OPTICAL RESULTS (MEASURED):



LED V6 HD Gen 7
 FWHM / FWTM 12.0° / 23.0°
 Efficiency 94 %
 Peak intensity 7.7 cd/lm
 LEDs/each optic 1
 Light colour/type White
 Required components:
 F15255_HEKLA-SOCKET-C

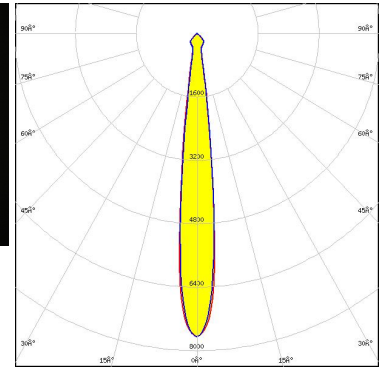

Light distribution files



LED V6 HD Gen 7
 FWHM / FWTM 16.0° / 41.0°
 Efficiency 89 %
 Peak intensity 4.1 cd/lm
 LEDs/each optic 1
 Light colour/type White
 Required components:
 F15255_HEKLA-SOCKET-C
 C14658_BARBARA-RZ-LENS

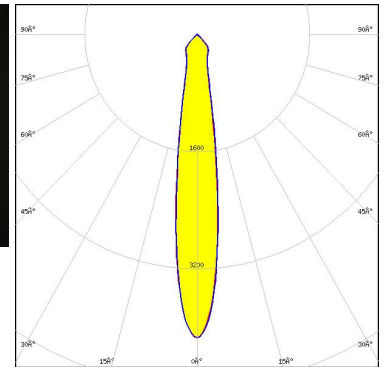
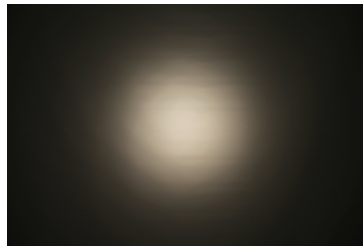

Light distribution files



LED V8 Gen 8-9
 FWHM / FWTM 15.0° / 29.0°
 Efficiency 96 %
 Peak intensity 5.5 cd/lm
 LEDs/each optic 1
 Light colour/type White
 Required components:
 F15253_HEKLA-SOCKET-A

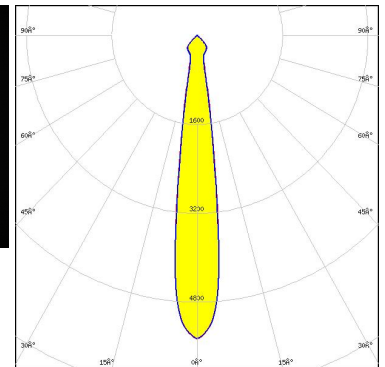

Light distribution files

OPTICAL RESULTS (MEASURED):

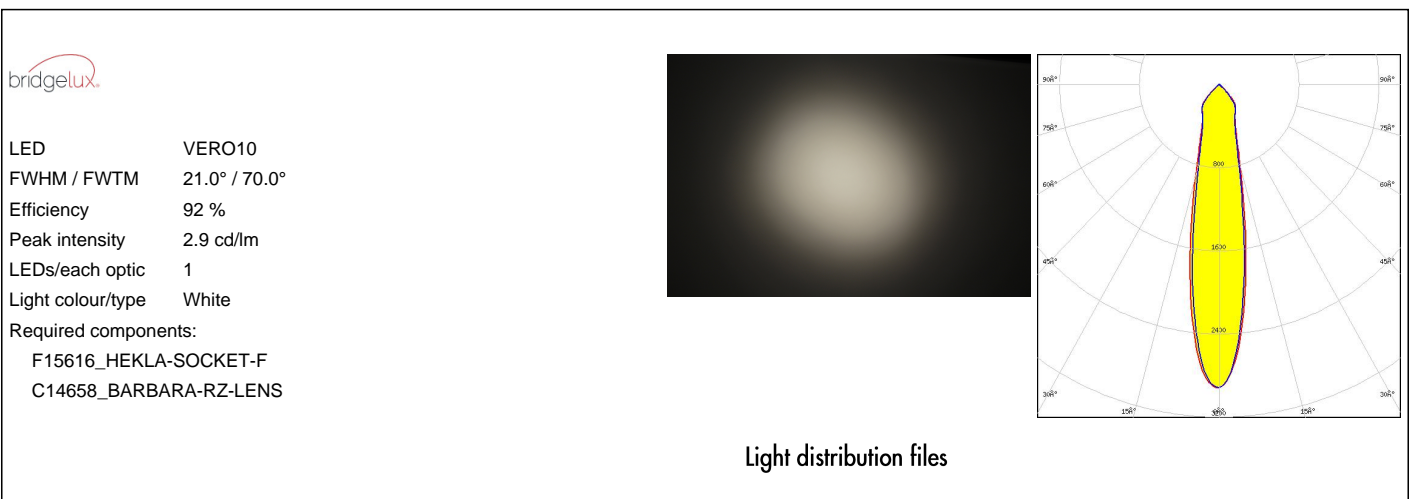
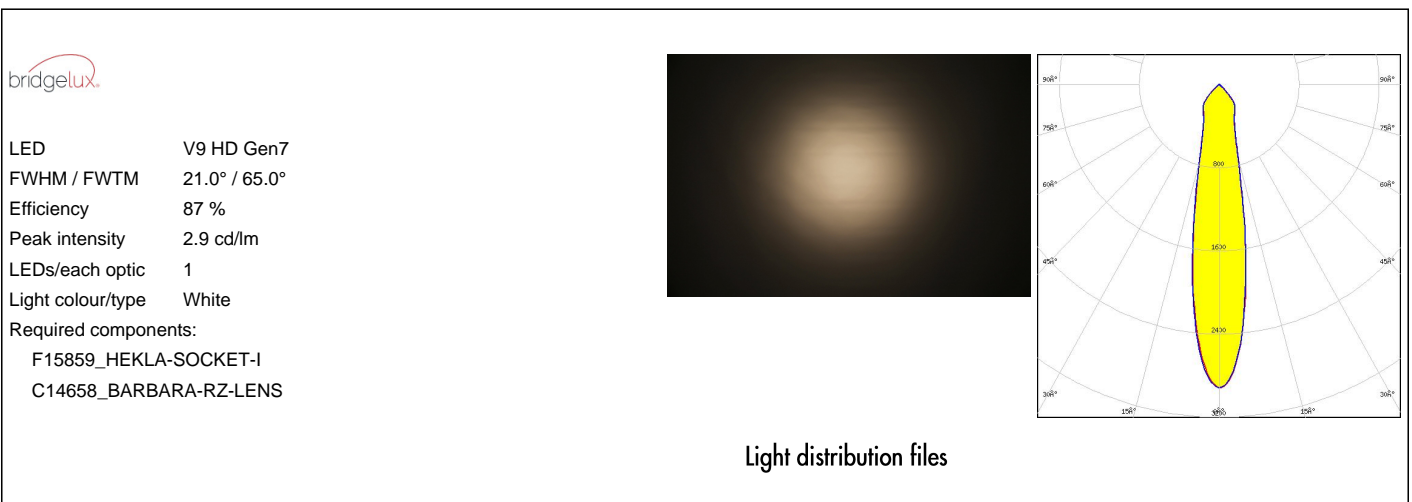
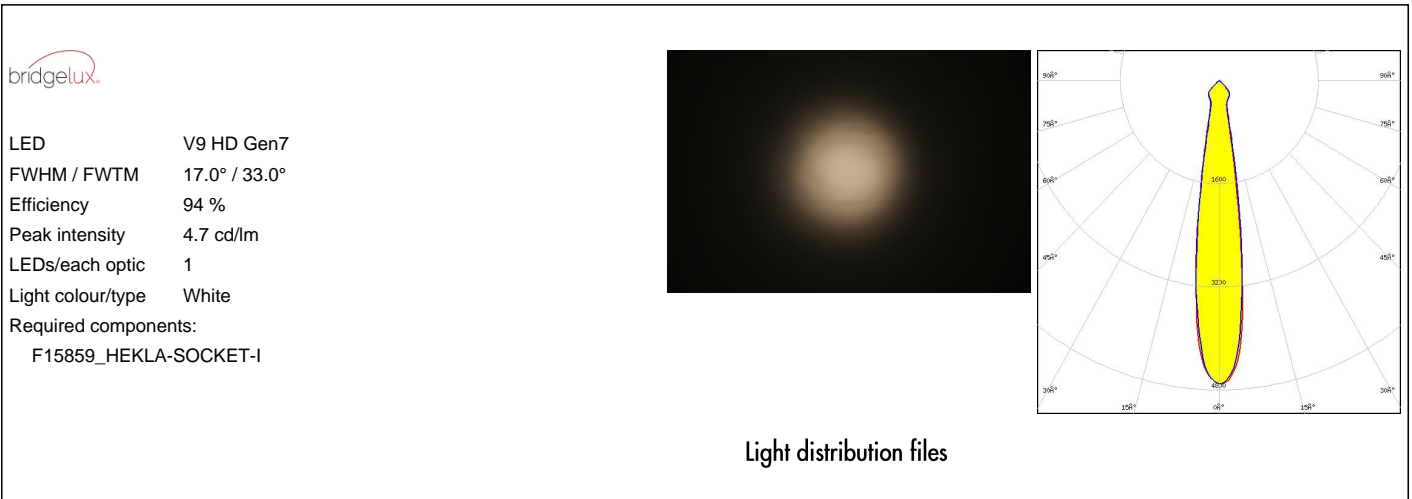

OPTICAL RESULTS (MEASURED):



LED VERO10
FWHM / FWTM 16.0° / 33.0°
Efficiency 94 %
Peak intensity 5.1 cd/lm
LEDs/each optic 1
Light colour/type White
Required components:
 F15616_HEKLA-SOCKET-F

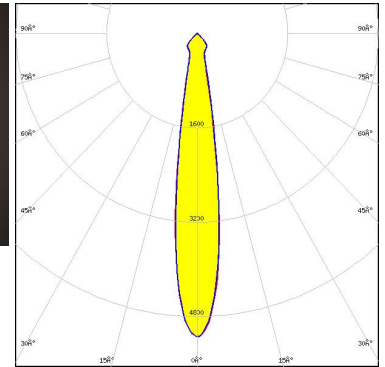

Light distribution files



LED VERO13
FWHM / FWTM 23.0° / 76.0°
Efficiency 90 %
Peak intensity 2.6 cd/lm
LEDs/each optic 1
Light colour/type White
Required components:
 C16142_HEKLA-SOCKET-K

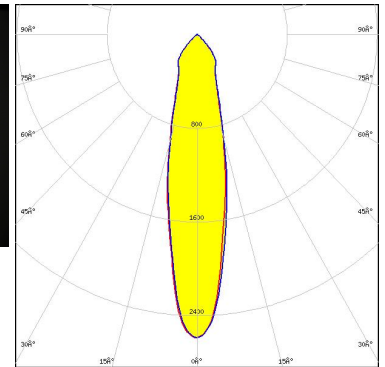
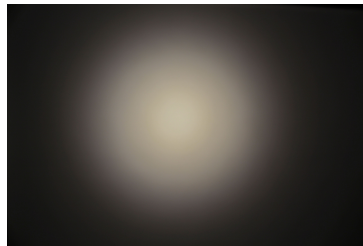

Light distribution files



LED VERO18
FWHM / FWTM 38.0° / 87.0°
Efficiency 89 %
Peak intensity 1.4 cd/lm
LEDs/each optic 1
Light colour/type White
Required components:
 C16142_HEKLA-SOCKET-K

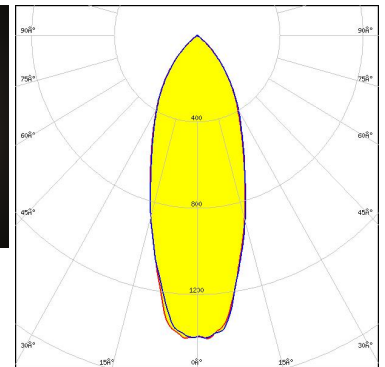
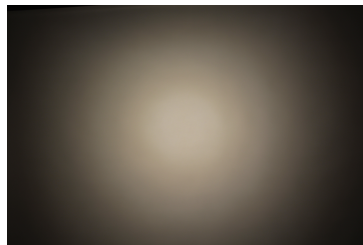

Light distribution files

OPTICAL RESULTS (MEASURED):



LED Vesta DTW 13mm (21W)
 FWHM / FWTM 32.0° / 85.0°
 Efficiency 85 %
 Peak intensity 1.6 cd/lm
 LEDs/each optic 1
 Light colour/type Tunable White

Required components:

C16142_HEKLA-SOCKET-K
 C14658_BARBARA-RZ-LENS
 Bender Wirth: 491 Typ L8

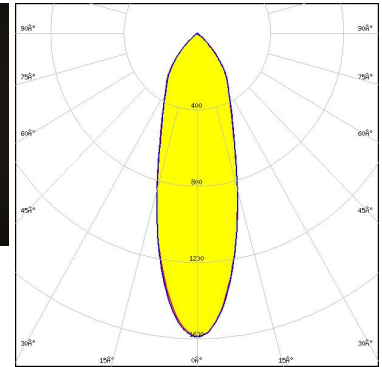
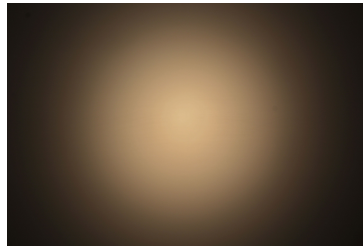

Light distribution files



LED Vesta DTW 13mm (21W)
 FWHM / FWTM 27.0° / 80.0°
 Efficiency 90 %
 Peak intensity 2.2 cd/lm
 LEDs/each optic 1
 Light colour/type Tunable White

Required components:

C16142_HEKLA-SOCKET-K
 Bender Wirth: 491 Typ L8

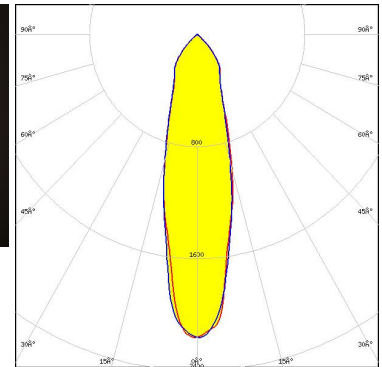
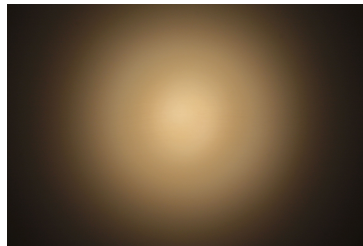

Light distribution files



LED Vesta DTW 15mm (33W)
 FWHM / FWTM 27.0° / 79.0°
 Efficiency 91 %
 Peak intensity 2.1 cd/lm
 LEDs/each optic 1
 Light colour/type White

Required components:

C16142_HEKLA-SOCKET-K
 Bender Wirth: 491 Typ L8

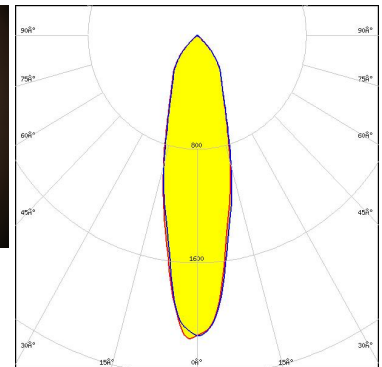
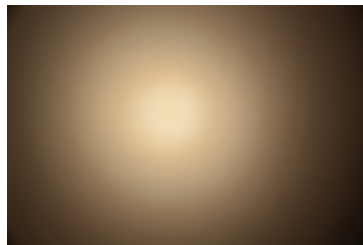

Light distribution files

OPTICAL RESULTS (MEASURED):



LED Vesta DTW 15mm (33W)
 FWHM / FWTM 33.0° / 85.0°
 Efficiency 84 %
 Peak intensity 1.5 cd/lm
 LEDs/each optic 1
 Light colour/type White

Required components:

C16142_HEKLA-SOCKET-K
 C14658_BARBARA-RZ-LENS
 Bender Wirth: 491 Typ L8

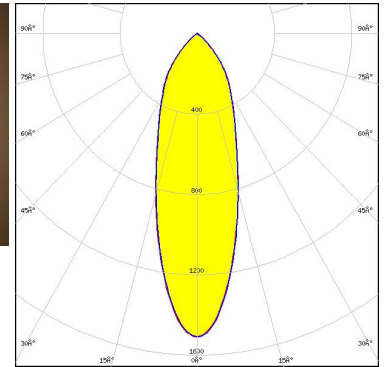
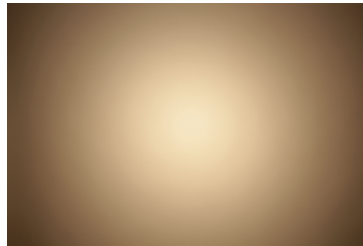

Light distribution files



LED Vesta DTW 9mm (4W/6W/12W)
 FWHM / FWTM 22.0° / 72.0°
 Efficiency 87 %
 Peak intensity 2.7 cd/lm
 LEDs/each optic 1
 Light colour/type White

Required components:

C16142_HEKLA-SOCKET-K
 C14658_BARBARA-RZ-LENS
 Bender Wirth: 490 Typ L8

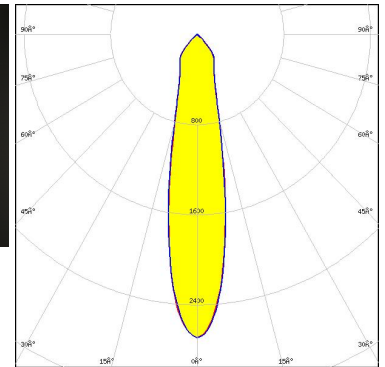
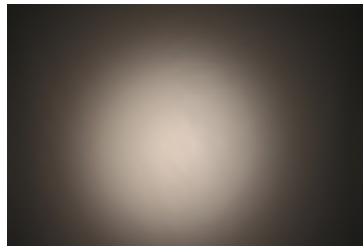

Light distribution files



LED Vesta DTW 9mm (4W/6W/12W)
 FWHM / FWTM 18.0° / 38.0°
 Efficiency 92 %
 Peak intensity 4.4 cd/lm
 LEDs/each optic 1
 Light colour/type White

Required components:

C16142_HEKLA-SOCKET-K
 Bender Wirth: 490 Typ L8

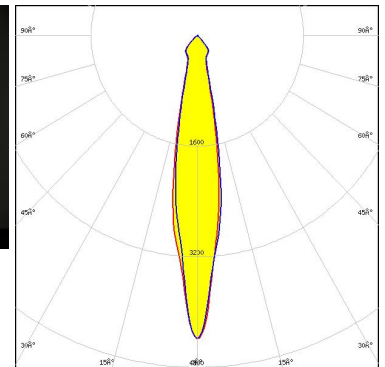

Light distribution files

OPTICAL RESULTS (MEASURED):



LED Vesta TW 13mm (25W) CSP
FWHM / FWTM 30.0° / 82.0°
Efficiency 85 %
Peak intensity 1.7 cd/lm
LEDs/each optic 1
Light colour/type White
Required components:
 C16142_HEKLA-SOCKET-K
 C14658_BARBARA-RZ-LENS
 Bender Wirth: 492 Typ L8

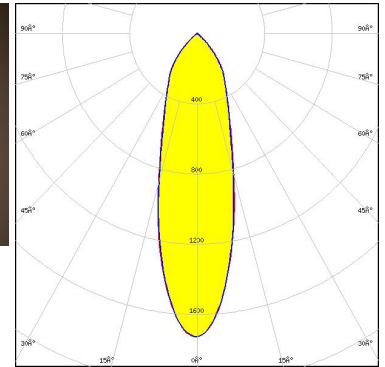
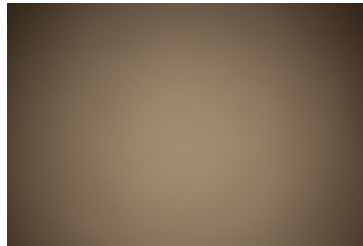

Light distribution files



LED Vesta TW 6mm DP
FWHM / FWTM 17.0° / 49.0°
Efficiency 85 %
Peak intensity 3.6 cd/lm
LEDs/each optic 1
Light colour/type White
Required components:
 C16142_HEKLA-SOCKET-K
 C14658_BARBARA-RZ-LENS
 Bender Wirth: 504 Typ L8

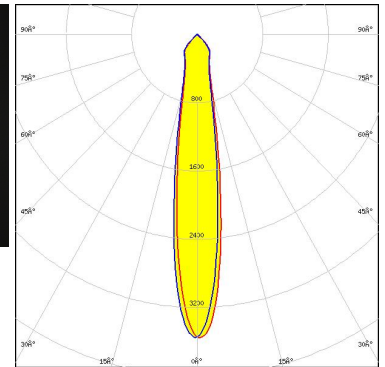

Light distribution files



LED Vesta TW 6mm DP
FWHM / FWTM 13.0° / 26.0°
Efficiency 90 %
Peak intensity 6.8 cd/lm
LEDs/each optic 1
Light colour/type White
Required components:
 C16142_HEKLA-SOCKET-K
 Bender Wirth: 504 Typ L8

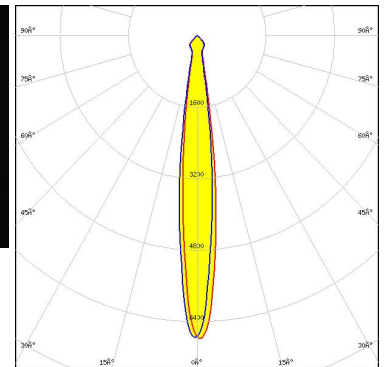

Light distribution files

OPTICAL RESULTS (MEASURED):



LED Vesta TW 9mm (12W) CSP
FWHM / FWTM 23.0° / 76.0°
Efficiency 85 %
Peak intensity 2.4 cd/lm
LEDs/each optic 1
Light colour/type White
Required components:
 C16142_HEKLA-SOCKET-K
 C14658_BARBARA-RZ-LENS
 Bender Wirth: 489 Typ L8

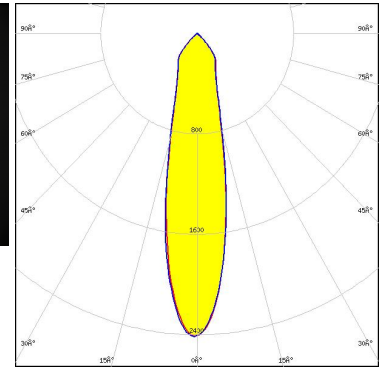
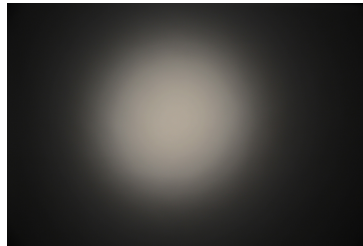

Light distribution files

CITIZEN

LED CLC020 Series (Dim-To-Warm)
FWHM / FWTM 26.0° / 81.0°
Efficiency 84 %
Peak intensity 2 cd/lm
LEDs/each optic 1
Light colour/type White
Required components:
 C16142_HEKLA-SOCKET-K
 C14658_BARBARA-RZ-LENS
 Bender Wirth: 487 Typ L8

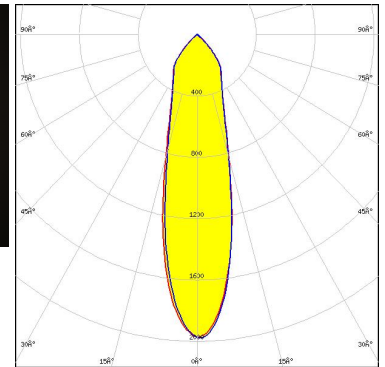
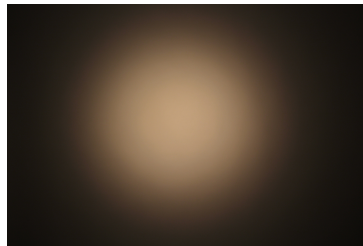

Light distribution files

CITIZEN

LED CLC030 Series (Dim-To-Warm)
FWHM / FWTM 30.0° / 84.0°
Efficiency %
Peak intensity 1.6 cd/lm
LEDs/each optic 1
Light colour/type White
Required components:
 C16142_HEKLA-SOCKET-K
 C14658_BARBARA-RZ-LENS
 Bender Wirth: 436 Typ L8

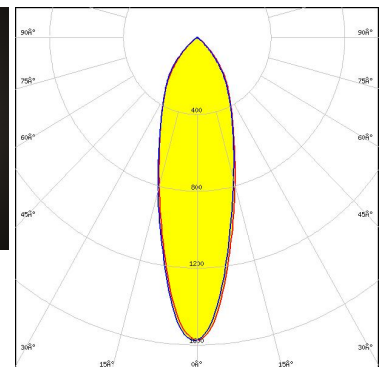
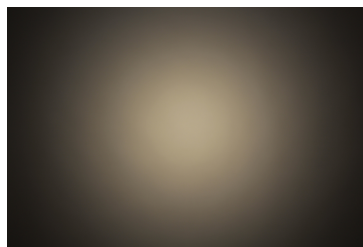

Light distribution files

OPTICAL RESULTS (MEASURED):

CITIZEN

LED CLC030 Series (Dim-To-Warm)
FWHM / FWTM 23.0° / 78.0°
Efficiency 89 %
Peak intensity 2.2 cd/lm
LEDs/each optic 1
Light colour/type White
Required components:
C16142_HEKLA-SOCKET-K

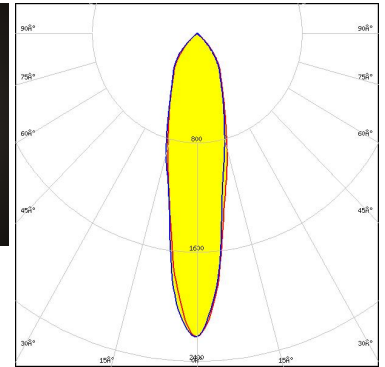
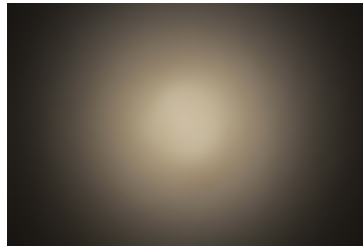

Light distribution files

CITIZEN

LED CLL02x/CLU02x (LES10)
FWHM / FWTM 16.0° / 33.0°
Efficiency 94 %
Peak intensity 4.8 cd/lm
LEDs/each optic 1
Light colour/type White
Required components:
F15255_HEKLA-SOCKET-C

CITIZEN

LED CLL02x/CLU02x (LES10)
FWHM / FWTM 16.0° / 33.0°
Efficiency 94 %
Peak intensity 4.8 cd/lm
LEDs/each optic 1
Light colour/type White
Required components:
F15255_HEKLA-SOCKET-C

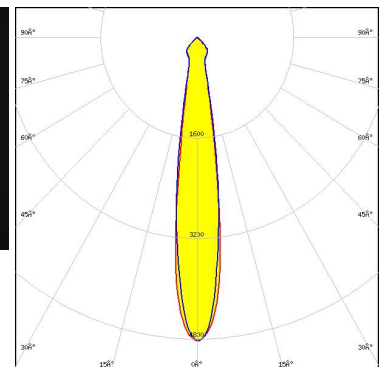
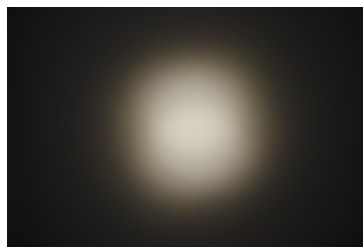

Light distribution files

OPTICAL RESULTS (MEASURED):

CITIZEN

LED CLU700/701/702/703
 FWHM / FWTM 12.0° / 22.0°
 Efficiency 94 %
 Peak intensity 7.8 cd/lm
 LEDs/each optic 1
 Light colour/type White
 Required components:
 F15255_HEKLA-SOCKET-C

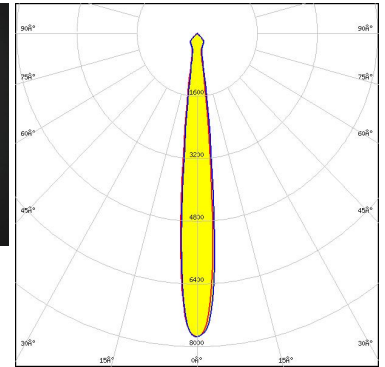

Light distribution files

CITIZEN

LED CLU700/701/702/703
 FWHM / FWTM 17.0° / 47.0°
 Efficiency 90 %
 Peak intensity 3.8 cd/lm
 LEDs/each optic 1
 Light colour/type White
 Required components:
 F15255_HEKLA-SOCKET-C
 C14658_BARBARA-RZ-LENS

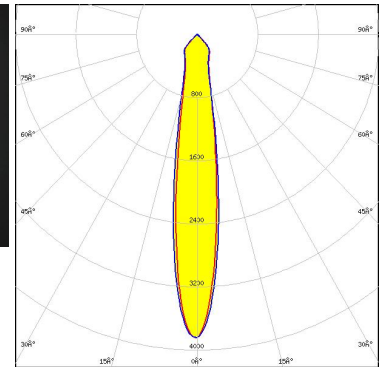

Light distribution files

CITIZEN

LED CLU7A2/7A3
 FWHM / FWTM 8.0° / 15.0°
 Efficiency 94 %
 Peak intensity 15.9 cd/lm
 LEDs/each optic 1
 Light colour/type White
 Required components:
 F15255_HEKLA-SOCKET-C

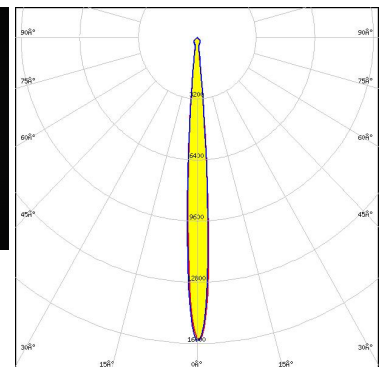

Light distribution files

OPTICAL RESULTS (MEASURED):

CITIZEN

LED LCN-C01B (Tunable White)
 FWHM / FWTM 25.0° / 79.0°
 Efficiency 86 %
 Peak intensity 2.2 cd/lm
 LEDs/each optic 1
 Light colour/type White
 Required components:
 C16142_HEKLA-SOCKET-K
 C14658_BARBARA-RZ-LENS
 Bender Wirth: 481 Typ L8

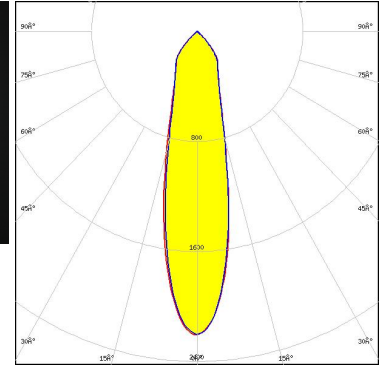

Light distribution files

CITIZEN

LED LCN-C02B (Tunable White)
 FWHM / FWTM 27.0° / 79.0°
 Efficiency 89 %
 Peak intensity 2.3 cd/lm
 LEDs/each optic 1
 Light colour/type White
 Required components:
 C16142_HEKLA-SOCKET-K

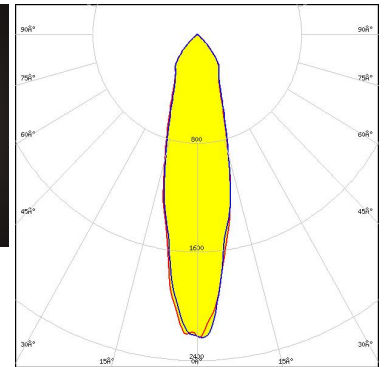
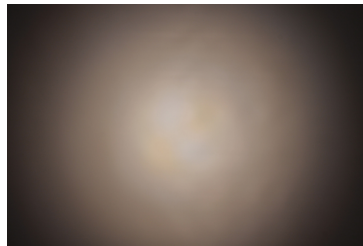

Light distribution files

CITIZEN

LED LCN-C02B (Tunable White)
 FWHM / FWTM 32.0° / 85.0°
 Efficiency 84 %
 Peak intensity 1.6 cd/lm
 LEDs/each optic 1
 Light colour/type White
 Required components:
 C16142_HEKLA-SOCKET-K
 C14658_BARBARA-RZ-LENS
 Bender Wirth: 481 Typ L8

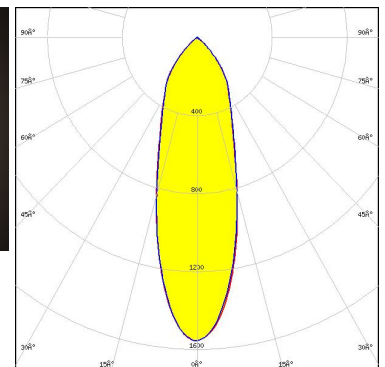
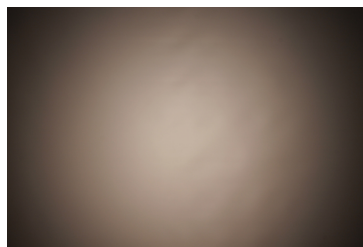

Light distribution files

OPTICAL RESULTS (MEASURED):



LED CMA1516
 FWHM / FWTM 18.0° / 36.0°
 Efficiency 94 %
 Peak intensity 4.2 cd/lm
 LEDs/each optic 1
 Light colour/type White
 Required components:
 F15256_HEKLA-SOCKET-D

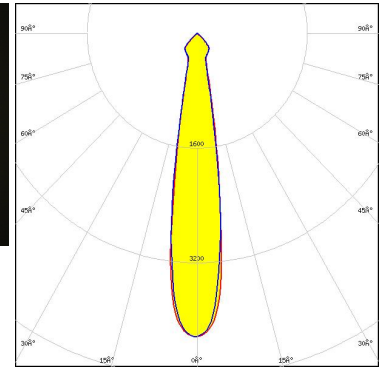
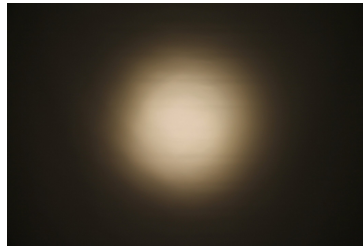

Light distribution files



LED CMA1825
 FWHM / FWTM 24.0° / 76.0°
 Efficiency 94 %
 Peak intensity 2.7 cd/lm
 LEDs/each optic 1
 Light colour/type White
 Required components:
 F15254_HEKLA-SOCKET-B

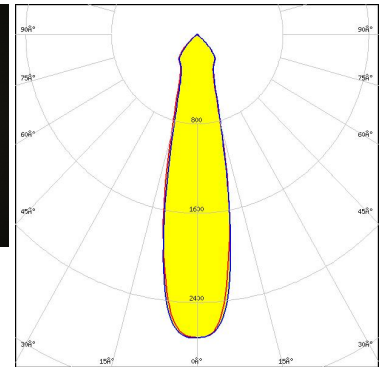
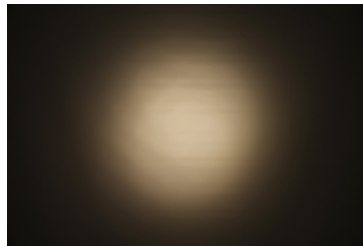

Light distribution files



LED CMT14xx
 FWHM / FWTM 19.0° / 41.0°
 Efficiency 95 %
 Peak intensity 3.8 cd/lm
 LEDs/each optic 1
 Light colour/type White
 Required components:
 F15255_HEKLA-SOCKET-C

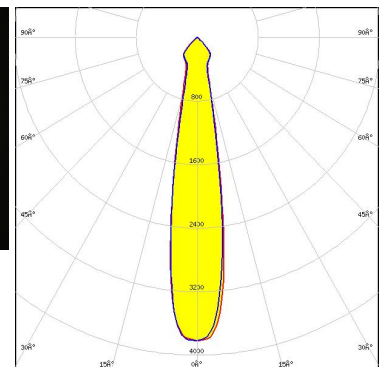
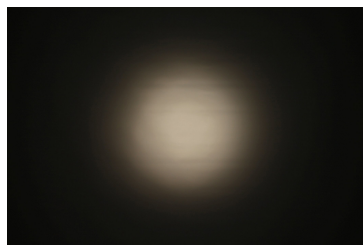

Light distribution files

OPTICAL RESULTS (MEASURED):



LED CXA/B 13xx
 FWHM / FWTM 11.0° / 22.0°
 Efficiency 94 %
 Peak intensity 8.2 cd/lm
 LEDs/each optic 1
 Light colour/type White
 Required components:
 F15956_HEKLA-SOCKET-J

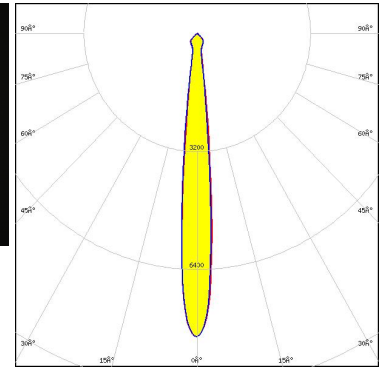

Light distribution files



LED CXA/B 15xx
 FWHM / FWTM 16.0° / 36.0°
 Efficiency 94 %
 Peak intensity 4.4 cd/lm
 LEDs/each optic 1
 Light colour/type White
 Required components:
 F15256_HEKLA-SOCKET-D

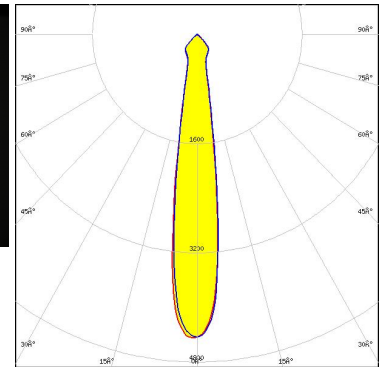

Light distribution files



LED LUXEON CX Plus CoB L08 (Gen2)
 FWHM / FWTM 29.0° / 83.0°
 Efficiency 92 %
 Peak intensity 2 cd/lm
 LEDs/each optic 1
 Light colour/type White
 Required components:
 Bender Wirth: 637a Hekla

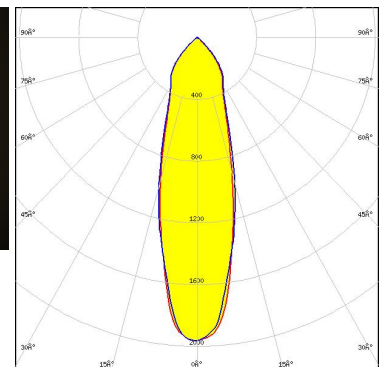
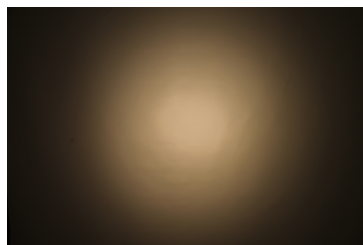

Light distribution files

OPTICAL RESULTS (MEASURED):



LED LUXEON CX Plus CoB L08 (Gen2)
FWHM / FWTM 35.0° / 87.0°
Efficiency 84 %
Peak intensity 1.4 cd/lm
LEDs/each optic 1
Light colour/type White
Required components:
C14658_BARBARA-RZ-LENS
Bender Wirth: 637a Hekla

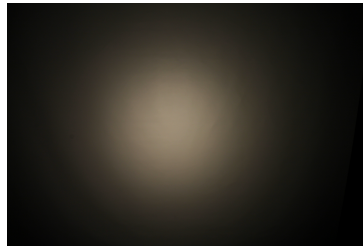

Light distribution files



LED LUXEON CoB 1202HD
FWHM / FWTM 13.0° / 23.0°
Efficiency 95 %
Peak intensity 7.5 cd/lm
LEDs/each optic 1
Light colour/type White
Required components:
F15848_HEKLA-SOCKET-G

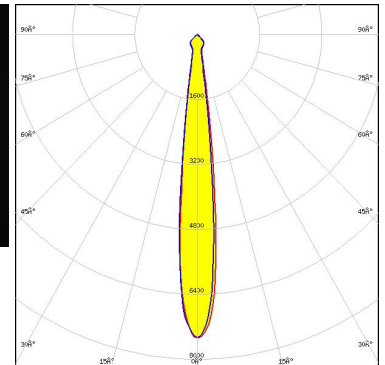

Light distribution files



LED LUXEON CoB 1204HD
FWHM / FWTM 18.0° / 35.0°
Efficiency 96 %
Peak intensity 4.6 cd/lm
LEDs/each optic 1
Light colour/type White
Required components:
F15858_HEKLA-SOCKET-H

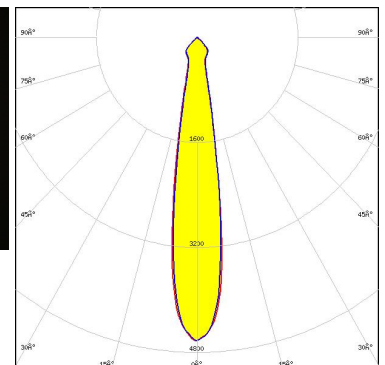
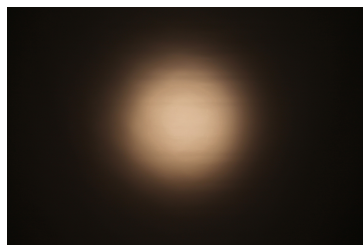

Light distribution files

OPTICAL RESULTS (MEASURED):



LED LUXEON CoB 1205HD
FWHM / FWTM 22.0° / 58.0°
Efficiency 94 %
Peak intensity 3.2 cd/lm
LEDs/each optic 1
Light colour/type White
Required components:
 F15858_HEKLA-SOCKET-H

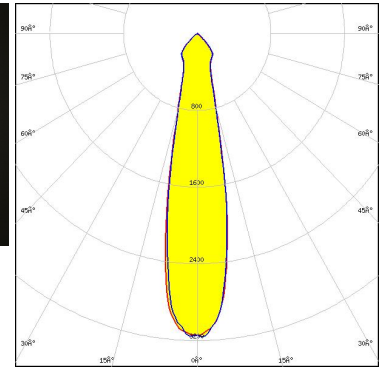
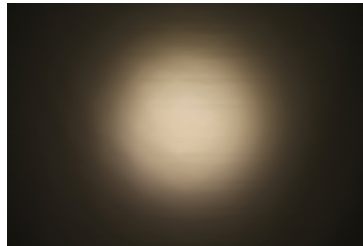

Light distribution files



LED LUXEON CoB 1208
FWHM / FWTM 29.0° / 82.0°
Efficiency 92 %
Peak intensity 2 cd/lm
LEDs/each optic 1
Light colour/type White
Required components:
 Bender Wirth: 632a Hekla XL

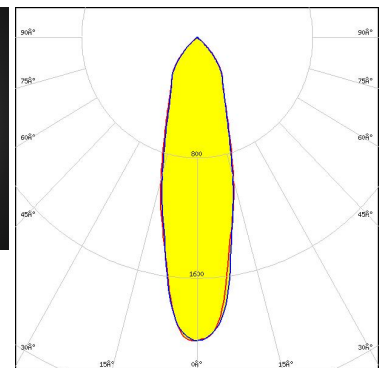
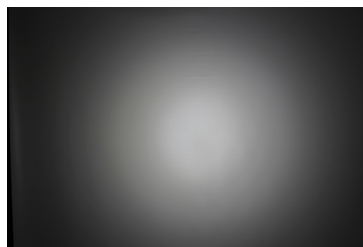

Light distribution files



LED LUXEON CX Plus CoB - HD S01H4
FWHM / FWTM 13.0° / 23.0°
Efficiency 93 %
Peak intensity 7.8 cd/lm
LEDs/each optic 1
Light colour/type White
Required components:
 Bender Wirth: 634c Hekla

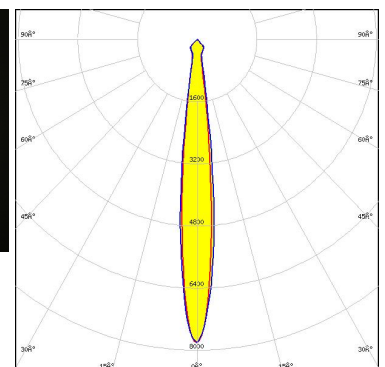
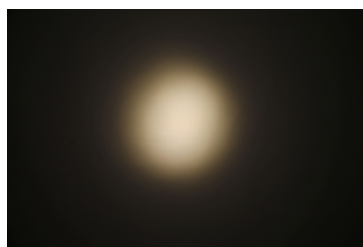

Light distribution files

OPTICAL RESULTS (MEASURED):



LED LUXEON CX Plus CoB - HD S01H4
 FWHM / FWTM 18.0° / 54.0°
 Efficiency 86 %
 Peak intensity 3.4 cd/lm
 LEDs/each optic 1
 Light colour/type White
 Required components:
 C14658_BARBARA-RZ-LENS
 Bender Wirth: 634c Hekla

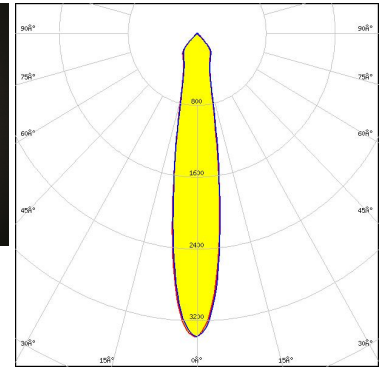

Light distribution files



LED LUXEON CX Plus CoB - HD S02H6
 FWHM / FWTM 14.0° / 25.0°
 Efficiency 93 %
 Peak intensity 7 cd/lm
 LEDs/each optic 1
 Light colour/type White
 Required components:
 Bender Wirth: 634c Hekla

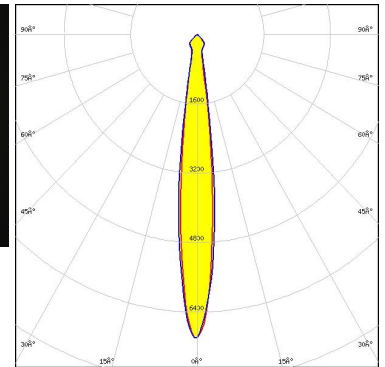

Light distribution files



LED LUXEON CX Plus CoB - HD S02H6
 FWHM / FWTM 20.0° / 60.0°
 Efficiency 86 %
 Peak intensity 3.1 cd/lm
 LEDs/each optic 1
 Light colour/type White
 Required components:
 C14658_BARBARA-RZ-LENS
 Bender Wirth: 634c Hekla

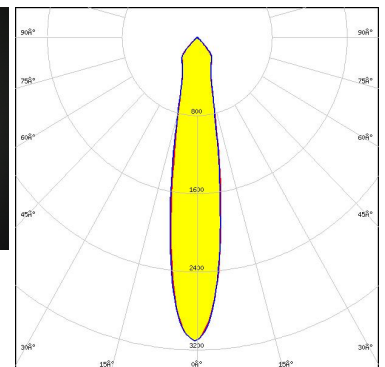
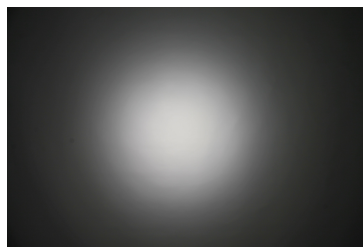

Light distribution files

OPTICAL RESULTS (MEASURED):



LED LUXEON CX Plus CoB - HD S04H9
 FWHM / FWTM 18.0° / 40.0°
 Efficiency 93 %
 Peak intensity 4 cd/lm
 LEDs/each optic 1
 Light colour/type White
 Required components:
 Bender Wirth: 634c Hekla

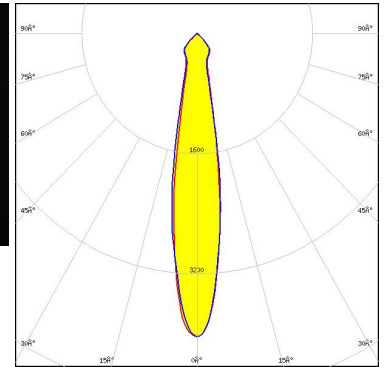

Light distribution files



LED LUXEON CX Plus CoB - HD S04H9
 FWHM / FWTM 23.0° / 78.0°
 Efficiency 86 %
 Peak intensity 2.4 cd/lm
 LEDs/each optic 1
 Light colour/type White
 Required components:
 C14658_BARBARA-RZ-LENS
 Bender Wirth: 634c Hekla

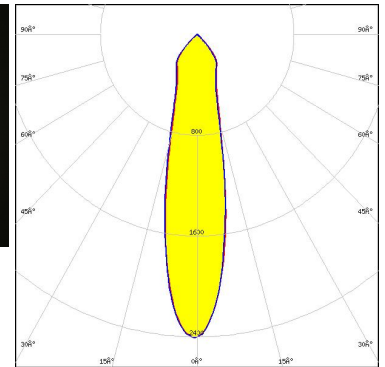
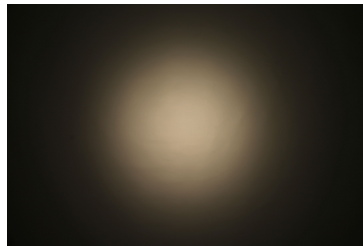

Light distribution files



LED LUXEON CX Plus CoB L04 / L05 (Gen2)
 FWHM / FWTM 23.0° / 75.0°
 Efficiency 92 %
 Peak intensity 2.8 cd/lm
 LEDs/each optic 1
 Light colour/type White
 Required components:
 Bender Wirth: 637a Hekla

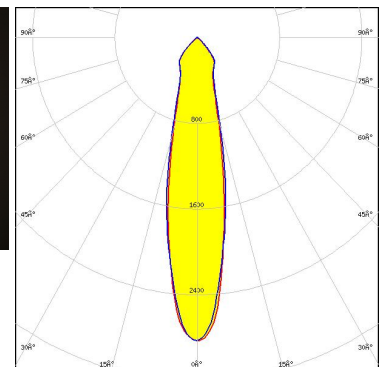
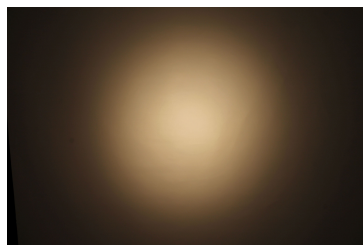

Light distribution files

OPTICAL RESULTS (MEASURED):



LED LUXEON CX Plus CoB L04 / L05 (Gen2)
 FWHM / FWTM 28.0° / 83.0°
 Efficiency 85 %
 Peak intensity 1.9 cd/lm
 LEDs/each optic 1
 Light colour/type White
 Required components:
 C14658_BARBARA-RZ-LENS
 Bender Wirth: 637a Hekla

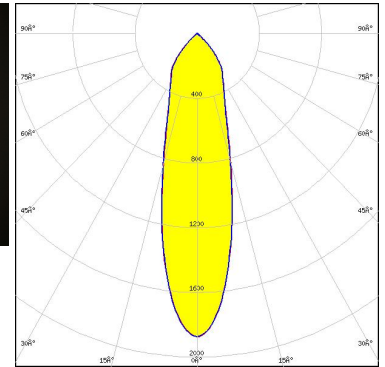
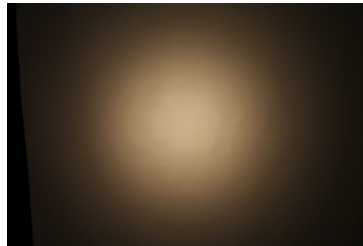

Light distribution files



LED LUXEON CX Plus CoB M02 / M03 (Gen2)
 FWHM / FWTM 23.0° / 77.0°
 Efficiency 86 %
 Peak intensity 2.5 cd/lm
 LEDs/each optic 1
 Light colour/type White
 Required components:
 C14658_BARBARA-RZ-LENS
 Bender Wirth: 641a Hekla

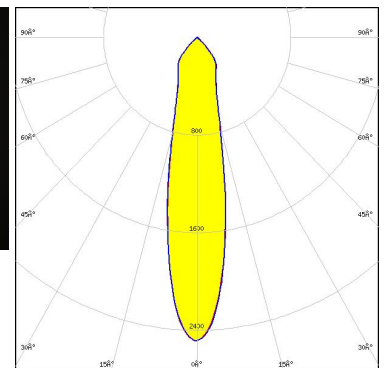
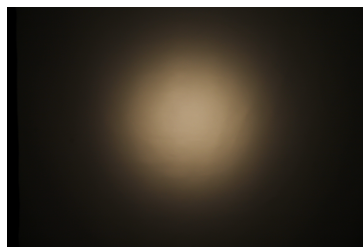

Light distribution files



LED LUXEON CX Plus CoB M02 / M03 (Gen2)
 FWHM / FWTM 17.0° / 38.0°
 Efficiency 92 %
 Peak intensity 4.4 cd/lm
 LEDs/each optic 1
 Light colour/type White
 Required components:
 Bender Wirth: 641a Hekla

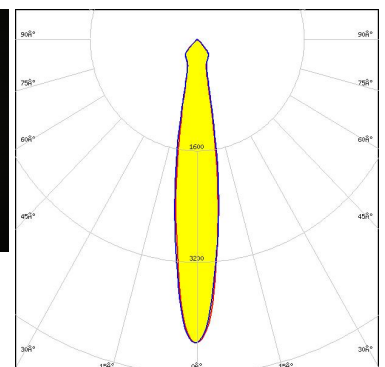

Light distribution files

OPTICAL RESULTS (MEASURED):



LED LUXEON CX Plus CoB S01 (Gen2)
 FWHM / FWTM 19.0° / 56.0°
 Efficiency 86 %
 Peak intensity 3.3 cd/lm
 LEDs/each optic 1
 Light colour/type White
 Required components:
 C14658_BARBARA-RZ-LENS
 Bender Wirth: 634c Hekla

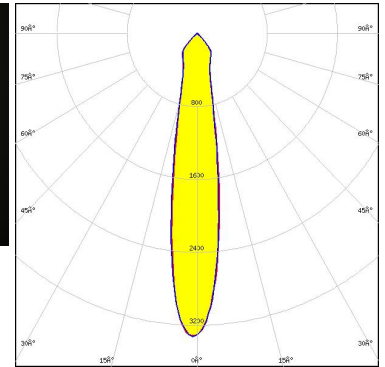
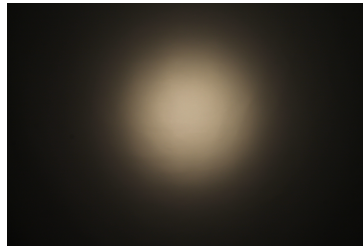

Light distribution files



LED LUXEON CX Plus CoB S01 (Gen2)
 FWHM / FWTM 12.0° / 24.0°
 Efficiency 93 %
 Peak intensity 7.4 cd/lm
 LEDs/each optic 1
 Light colour/type White
 Required components:
 Bender Wirth: 634c Hekla

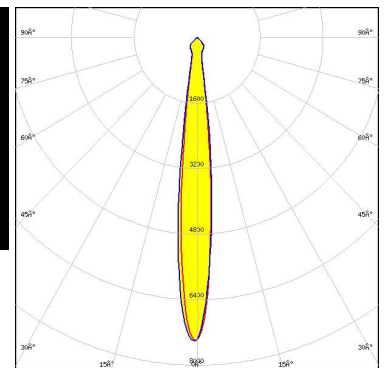

Light distribution files



LED CDM-14 (Dim-To-Warm)
 FWHM / FWTM 28.0° / 81.0°
 Efficiency 83 %
 Peak intensity 1.8 cd/lm
 LEDs/each optic 1
 Light colour/type White
 Required components:
 C16142_HEKLA-SOCKET-K
 C14658_BARBARA-RZ-LENS
 Bender Wirth: 491 Typ L8

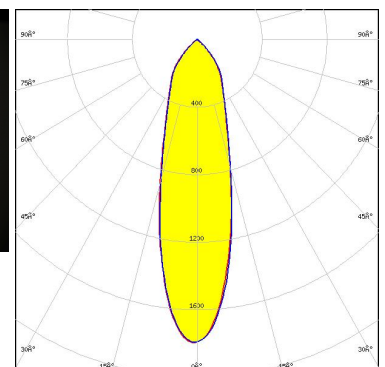
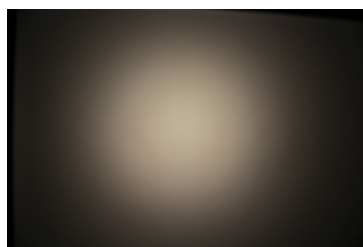

Light distribution files

OPTICAL RESULTS (MEASURED):



LED CDM-6 (Dim-To-Warm)
 FWHM / FWTM 18.0° / 45.0°
 Efficiency 86 %
 Peak intensity 3.6 cd/lm
 LEDs/each optic 1
 Light colour/type White

Required components:

C16142_HEKLA-SOCKET-K
 C14658_BARBARA-RZ-LENS
 Bender Wirth: 490 Typ L8

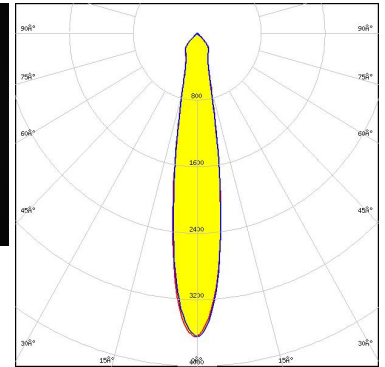

Light distribution files



LED CDM-9 (Dim-To-Warm)
 FWHM / FWTM 17.0° / 35.0°
 Efficiency 90 %
 Peak intensity 4.8 cd/lm
 LEDs/each optic 1
 Light colour/type White

Required components:

C16142_HEKLA-SOCKET-K
 Bender Wirth: 490 Typ L8

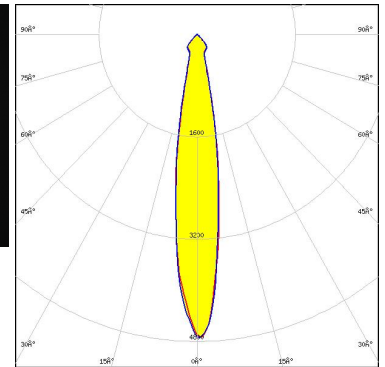

Light distribution files



LED CDM-9 (Dim-To-Warm)
 FWHM / FWTM 21.0° / 56.0°
 Efficiency 85 %
 Peak intensity 3.1 cd/lm
 LEDs/each optic 1
 Light colour/type White

Required components:

C16142_HEKLA-SOCKET-K
 C14658_BARBARA-RZ-LENS
 Bender Wirth: 490 Typ L8

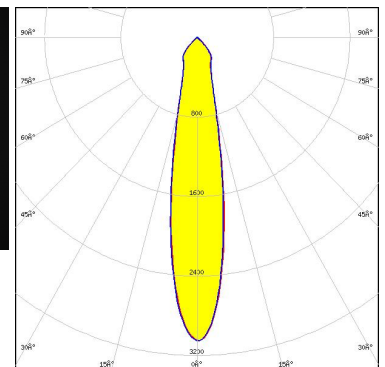
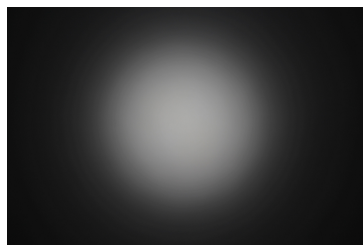

Light distribution files

OPTICAL RESULTS (MEASURED):



LED CTM-9 (Tunable White)
 FWHM / FWTM 22.0° / 65.0°
 Efficiency 85 %
 Peak intensity 2.8 cd/lm
 LEDs/each optic 1
 Light colour/type White
 Required components:
 C16142_HEKLA-SOCKET-K
 C14658_BARBARA-RZ-LENS
 Bender Wirth: 495 Typ L8

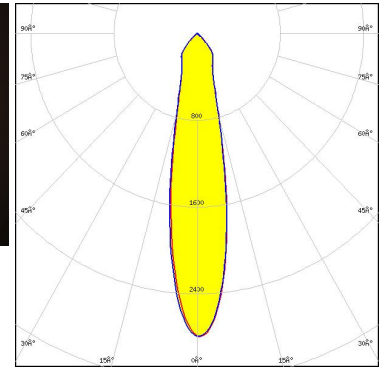

Light distribution files



LED CxM-14 (19x19)
 FWHM / FWTM 29.0° / 83.0°
 Efficiency 94 %
 Peak intensity 2.1 cd/lm
 LEDs/each optic 1
 Light colour/type White
 Required components:
 F15859_HEKLA-SOCKET-I

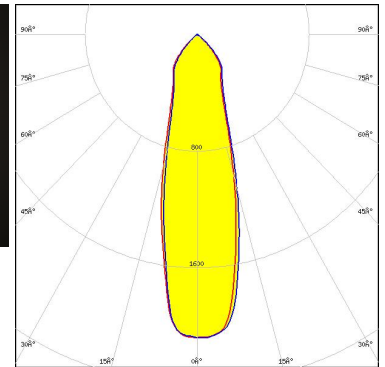
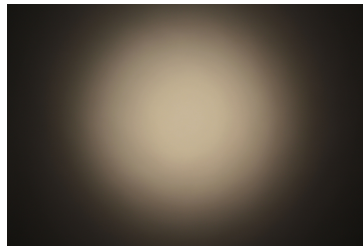

Light distribution files



LED CXM-4
 FWHM / FWTM 9.0° / 16.0°
 Efficiency 94 %
 Peak intensity 13.6 cd/lm
 LEDs/each optic 1
 Light colour/type White
 Required components:
 F15255_HEKLA-SOCKET-C

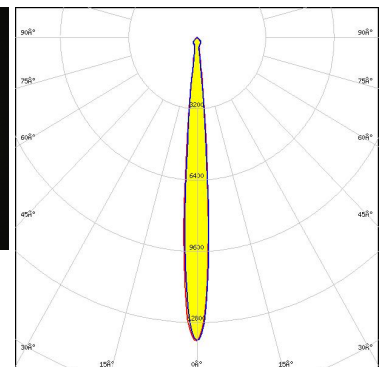

Light distribution files

OPTICAL RESULTS (MEASURED):



LED CXM-4
FWHM / FWTM 14.0° / 35.0°
Efficiency 89 %
Peak intensity 4.9 cd/lm
LEDs/each optic 1
Light colour/type White
Required components:
 F15255_HEKLA-SOCKET-C
 C14658_BARBARA-RZ-LENS

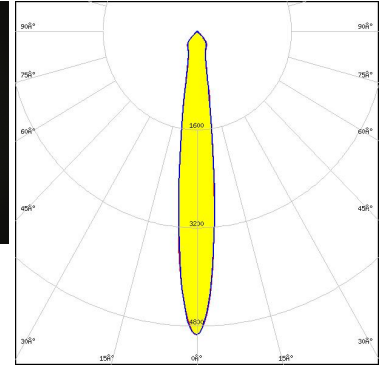

Light distribution files



LED CxM-9 (13.5x13.5)
FWHM / FWTM 18.0° / 44.0°
Efficiency 94 %
Peak intensity 3.9 cd/lm
LEDs/each optic 1
Light colour/type White
Required components:
 F15255_HEKLA-SOCKET-C

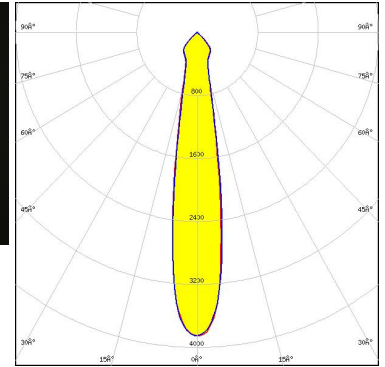

Light distribution files



LED NJCWL024Z-V1MT: COB L-Type Tunable White
FWHM / FWTM 15.0° / 31.0°
Efficiency 86 %
Peak intensity 5.1 cd/lm
LEDs/each optic 1
Light colour/type White
Required components:
 C16142_HEKLA-SOCKET-K
 Bender Wirth: 497 Typ L8

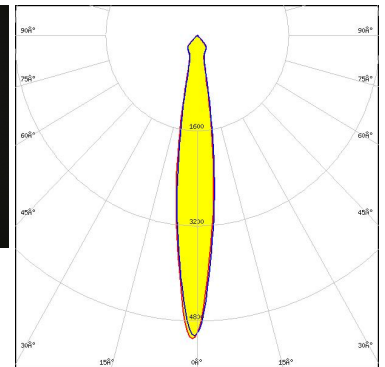
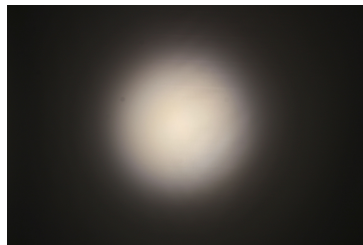

Light distribution files

OPTICAL RESULTS (MEASURED):



LED NJCWL024Z-V1MT: COB L-Type Tunable White
 FWHM / FWTM 18.0° / 57.0°
 Efficiency 81 %
 Peak intensity 3.1 cd/lm
 LEDs/each optic 1
 Light colour/type White
 Required components:
 C16142_HEKLA-SOCKET-K
 C14658_BARBARA-RZ-LENS
 Bender Wirth: 497 Typ L8

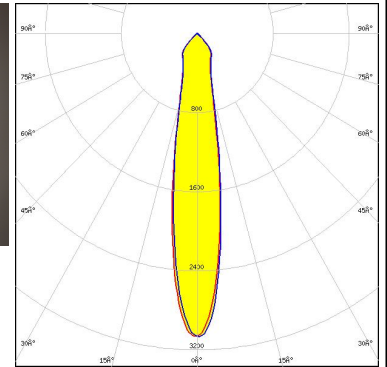
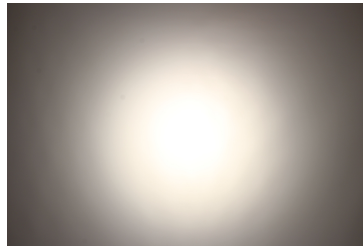

Light distribution files



LED NVCWJ024Z-V1MT: COB J-Type Tunable White
 FWHM / FWTM 25.0° / 79.0°
 Efficiency 85 %
 Peak intensity 2.2 cd/lm
 LEDs/each optic 1
 Light colour/type White
 Required components:
 C16142_HEKLA-SOCKET-K
 C14658_BARBARA-RZ-LENS
 Bender Wirth: 498 Typ L2

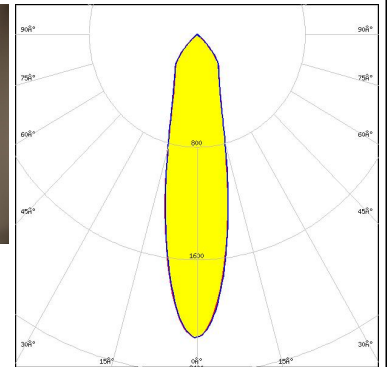
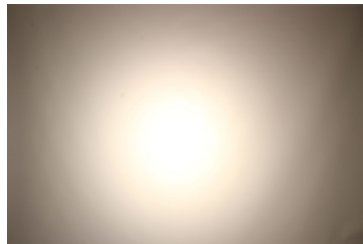

Light distribution files



LED Fortimo SLM L09 CoB
 FWHM / FWTM 21.0° / 70.0°
 Efficiency 89 %
 Peak intensity 2.8 cd/lm
 LEDs/each optic 1
 Light colour/type White
 Required components:
 F15858_HEKLA-SOCKET-H
 C14658_BARBARA-RZ-LENS

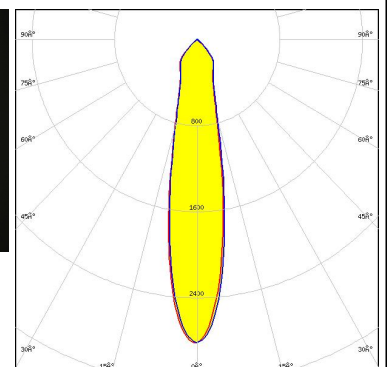
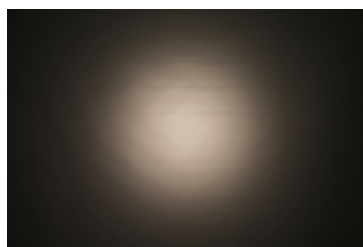

Light distribution files

OPTICAL RESULTS (MEASURED):

PHILIPS

LED Fortimo SLM L09 CoB
 FWHM / FWTM 18.0° / 38.0°
 Efficiency 94 %
 Peak intensity 4.2 cd/lm
 LEDs/each optic 1
 Light colour/type White
 Required components:
 F15858_HEKLA-SOCKET-H

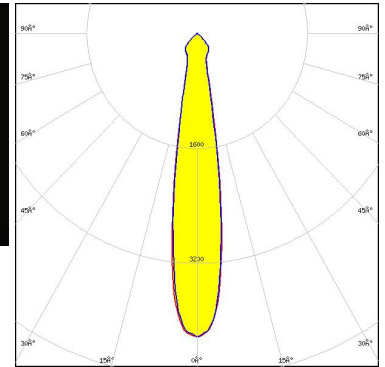

Light distribution files

PHILIPS

LED Fortimo SLM L13 CoB
 FWHM / FWTM 27.0° / 80.0°
 Efficiency 89 %
 Peak intensity 2.1 cd/lm
 LEDs/each optic 1
 Light colour/type White
 Required components:
 C16142_HEKLA-SOCKET-K
 Bender Wirth: 432 Typ L8

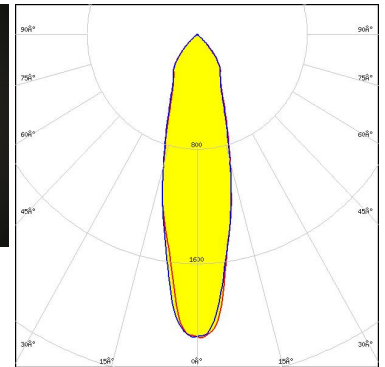

Light distribution files

PHILIPS

LED Fortimo SLM L13 CoB
 FWHM / FWTM 32.0° / 85.0°
 Efficiency 85 %
 Peak intensity 1.6 cd/lm
 LEDs/each optic 1
 Light colour/type White
 Required components:
 C16142_HEKLA-SOCKET-K
 C14658_BARBARA-RZ-LENS
 Bender Wirth: 432 Typ L8

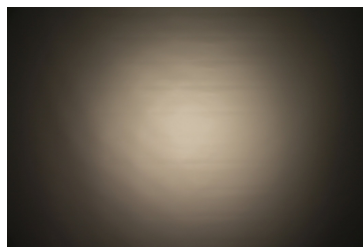

Light distribution files

OPTICAL RESULTS (MEASURED):

SAMSUNG

LED LC003D / LC006D / LC009D / LC013D
FWHM / FWTM 18.0° / 37.0°
Efficiency 94 %
Peak intensity 4.3 cd/lm
LEDs/each optic 1
Light colour/type White
Required components:
F15255_HEKLA-SOCKET-C

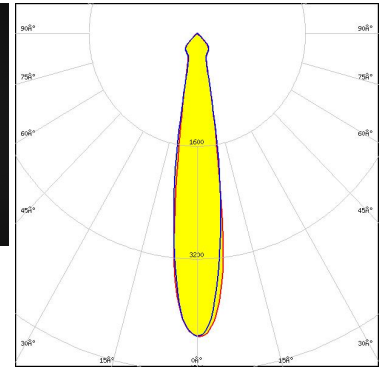

Light distribution files

SAMSUNG

LED LC003D / LC006D / LC009D / LC013D
FWHM / FWTM 22.0° / 70.0°
Efficiency 90 %
Peak intensity 2.8 cd/lm
LEDs/each optic 1
Light colour/type White
Required components:
F15255_HEKLA-SOCKET-C
C14658_BARBARA-RZ-LENS

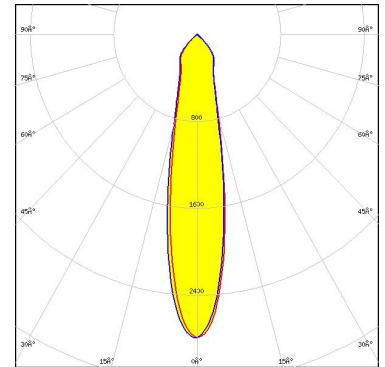

Light distribution files

SAMSUNG

LED LC003D / LC006D / LC009D / LC013D
FWHM / FWTM 18.0° / 37.0°
Efficiency 94 %
Peak intensity 4.3 cd/lm
LEDs/each optic 1
Light colour/type White
Required components:
F15255_HEKLA-SOCKET-C

OPTICAL RESULTS (MEASURED):

SAMSUNG

LED LC010C G2
 FWHM / FWTM 11.0° / 20.0°
 Efficiency 93 %
 Peak intensity 9 cd/lm
 LEDs/each optic 1
 Light colour/type White
 Required components:
 F15255_HEKLA-SOCKET-C

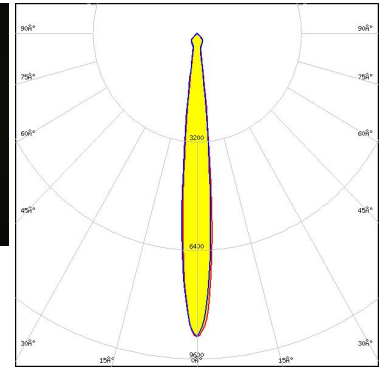

Light distribution files

SAMSUNG

LED LC010T (Tunable White)
 FWHM / FWTM 18.0° / 43.0°
 Efficiency 91 %
 Peak intensity 3.9 cd/lm
 LEDs/each optic 1
 Light colour/type Tunable White
 Required components:
 C16142_HEKLA-SOCKET-K
 Bender Wirth: 501 Typ L8

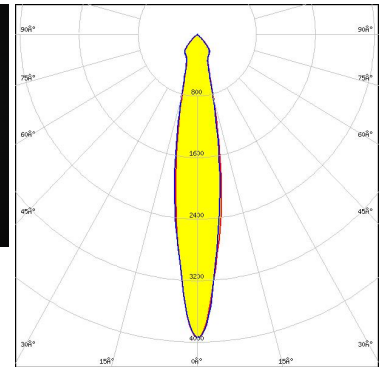

Light distribution files

SAMSUNG

LED LC010T (Tunable White)
 FWHM / FWTM 23.0° / 75.0°
 Efficiency 86 %
 Peak intensity 2.5 cd/lm
 LEDs/each optic 1
 Light colour/type Tunable White
 Required components:
 C16142_HEKLA-SOCKET-K
 C14658_BARBARA-RZ-LENS
 Bender Wirth: 501 Typ L8

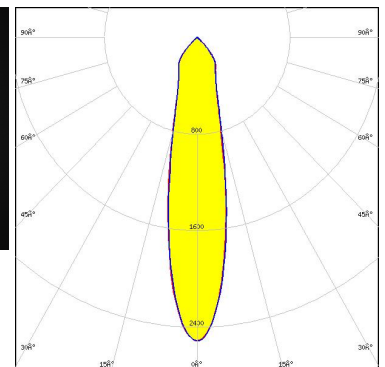
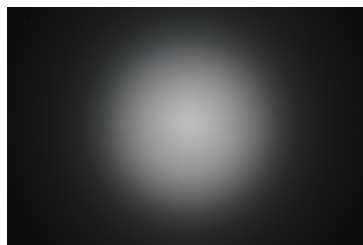

Light distribution files

OPTICAL RESULTS (MEASURED):

SAMSUNG

LED LC020C G2
 FWHM / FWTM 17.0° / 35.0°
 Efficiency 94 %
 Peak intensity 4.6 cd/lm
 LEDs/each optic 1
 Light colour/type White
 Required components:
 F15859_HEKLA-SOCKET-I

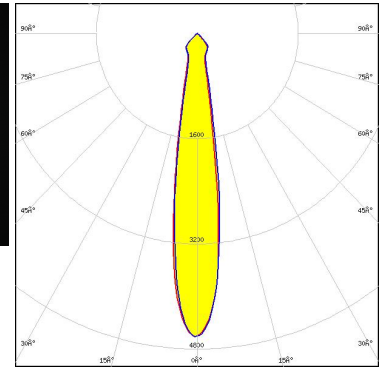

Light distribution files

SAMSUNG

LED LC020T (Tunable white)
 FWHM / FWTM 26.0° / 78.0°
 Efficiency 90 %
 Peak intensity 2.4 cd/lm
 LEDs/each optic 1
 Light colour/type Tunable White
 Required components:
 C16142_HEKLA-SOCKET-K
 Bender Wirth: 501 Typ L8

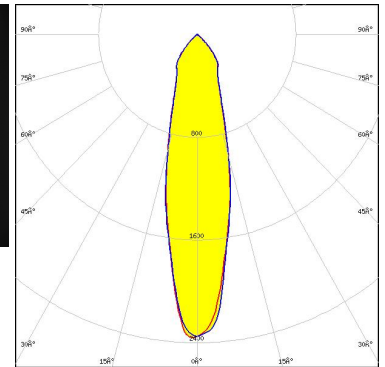
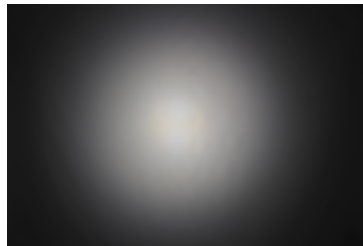

Light distribution files

SAMSUNG

LED LC020T (Tunable white)
 FWHM / FWTM 31.0° / 84.0°
 Efficiency 85 %
 Peak intensity 1.6 cd/lm
 LEDs/each optic 1
 Light colour/type Tunable White
 Required components:
 C16142_HEKLA-SOCKET-K
 C14658_BARBARA-RZ-LENS
 Bender Wirth: 501 Typ L8

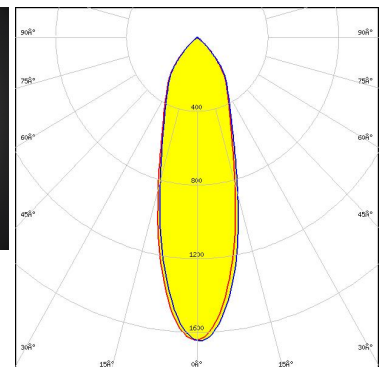
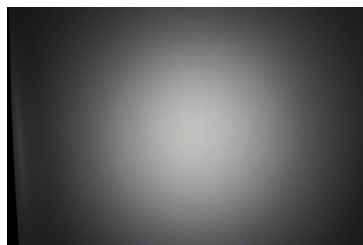

Light distribution files

OPTICAL RESULTS (MEASURED):

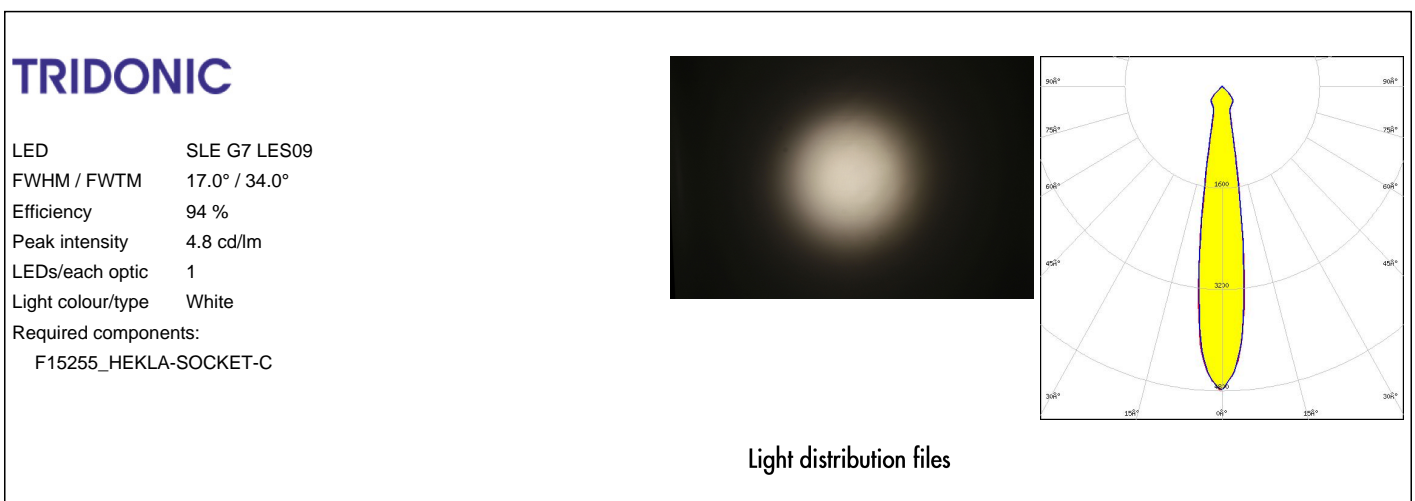
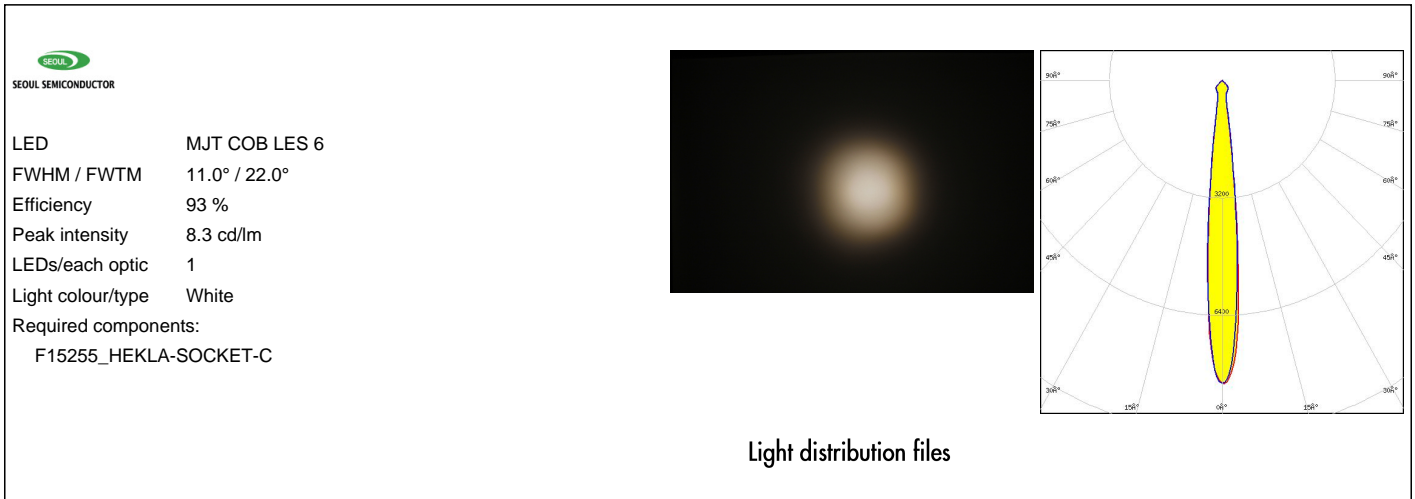

OPTICAL RESULTS (MEASURED):

TRIDONIC

LED SLE G7 LES09
 FWHM / FWTM 20.0° / 63.0°
 Efficiency 91 %
 Peak intensity 3.1 cd/lm
 LEDs/each optic 1
 Light colour/type White
 Required components:
 F15255_HEKLA-SOCKET-C
 C14658_BARBARA-RZ-LENS

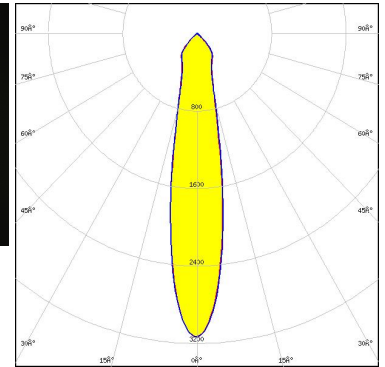
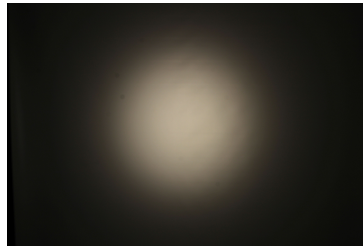

Light distribution files

TRIDONIC

LED SLE G7 LES13
 FWHM / FWTM 29.0° / 83.0°
 Efficiency 87 %
 Peak intensity 1.8 cd/lm
 LEDs/each optic 1
 Light colour/type White
 Required components:
 F15859_HEKLA-SOCKET-I
 C14658_BARBARA-RZ-LENS

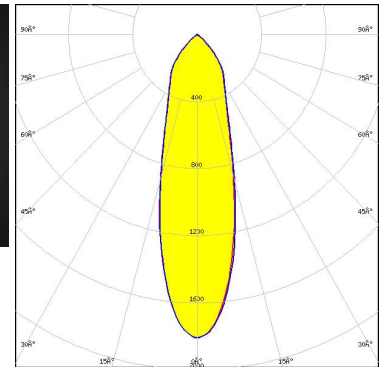

Light distribution files

TRIDONIC

LED SLE G7 LES13
 FWHM / FWTM 26.0° / 78.0°
 Efficiency 94 %
 Peak intensity 2.5 cd/lm
 LEDs/each optic 1
 Light colour/type White
 Required components:
 F15859_HEKLA-SOCKET-I

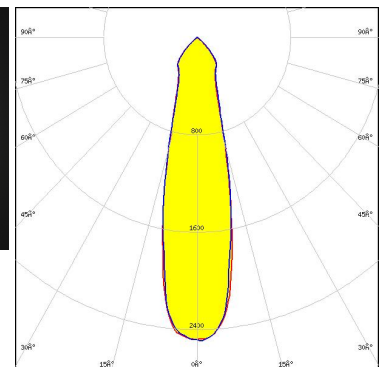
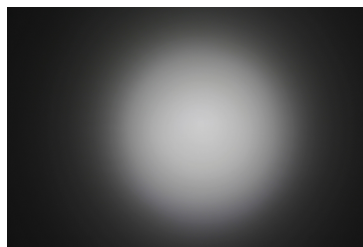

Light distribution files

OPTICAL RESULTS (MEASURED):

TRIDONIC

LED SLE G7 LES15
FWHM / FWTM 28.0° / 81.0°
Efficiency 94 %
Peak intensity 2.2 cd/lm
LEDs/each optic 1
Light colour/type White
Required components:
F15859_HEKLA-SOCKET-I

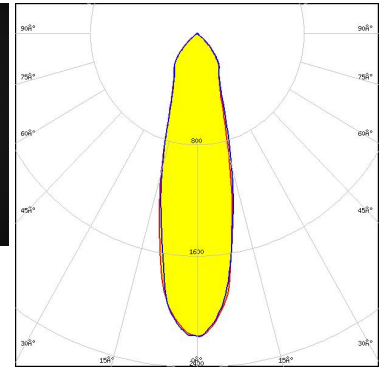
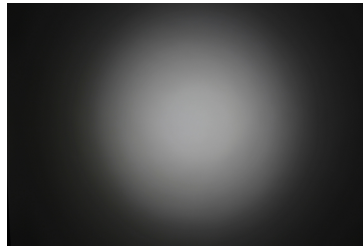

Light distribution files

XICATO

LED XOB 14.5 mm
FWHM / FWTM 27.0° / 82.0°
Efficiency 94 %
Peak intensity 2.2 cd/lm
LEDs/each optic 1
Light colour/type White
Required components:
F15859_HEKLA-SOCKET-I

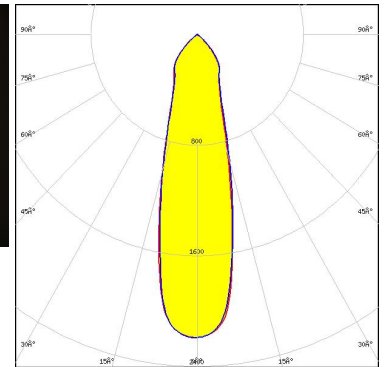
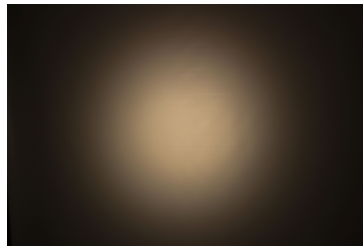

Light distribution files

XICATO

LED XOB 6 mm
FWHM / FWTM 15.0° / 41.0°
Efficiency 88 %
Peak intensity 4.2 cd/lm
LEDs/each optic 1
Light colour/type White
Required components:
F15255_HEKLA-SOCKET-C
C14658_BARBARA-RZ-LENS

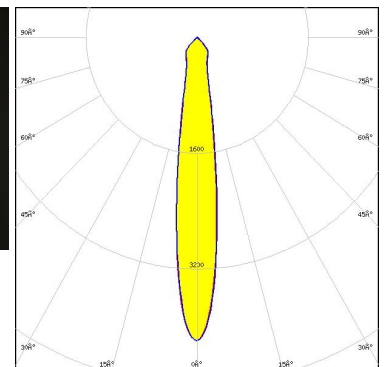
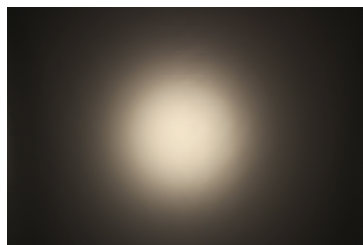

Light distribution files

OPTICAL RESULTS (MEASURED):

XICATO

LED XOB 6 mm
 FWHM / FWTM 11.0° / 21.0°
 Efficiency 94 %
 Peak intensity 8.7 cd/lm
 LEDs/each optic 1
 Light colour/type White
 Required components:
 F15255_HEKLA-SOCKET-C

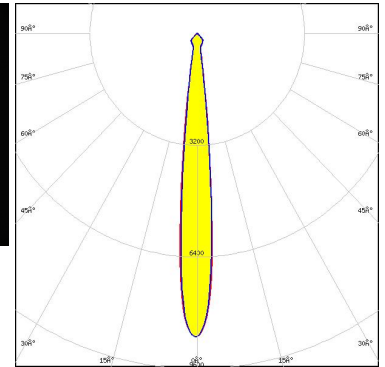

Light distribution files

XICATO

LED XOB 9.8 mm
 FWHM / FWTM 21.0° / 69.0°
 Efficiency 90 %
 Peak intensity 2.9 cd/lm
 LEDs/each optic 1
 Light colour/type White
 Required components:
 F15255_HEKLA-SOCKET-C
 C14658_BARBARA-RZ-LENS

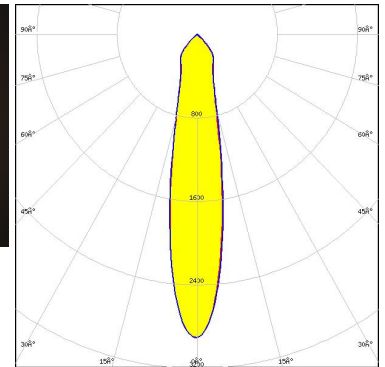
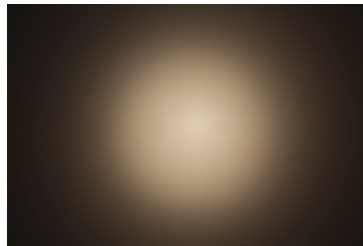

Light distribution files

XICATO

LED XOB 9.8 mm
 FWHM / FWTM 16.0° / 35.0°
 Efficiency 94 %
 Peak intensity 4.6 cd/lm
 LEDs/each optic 1
 Light colour/type White
 Required components:
 F15255_HEKLA-SOCKET-C

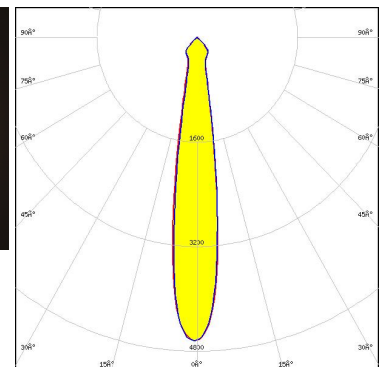

Light distribution files

OPTICAL RESULTS (MEASURED):

XICATO

LED XTM - 19mm LES
FWHM / FWTM 33.0° / 86.0°
Efficiency 92 %
Peak intensity 1.7 cd/lm
LEDs/each optic 1
Light colour/type White
Required components:
C15743_XTM-ADAPTER-50-B

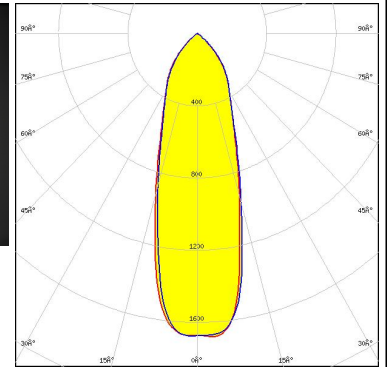

Light distribution files

XICATO

LED XTM - 9mm LES
FWHM / FWTM 17.0° / 33.0°
Efficiency 94 %
Peak intensity 4.8 cd/lm
LEDs/each optic 1
Light colour/type White
Required components:
C15743_XTM-ADAPTER-50-B

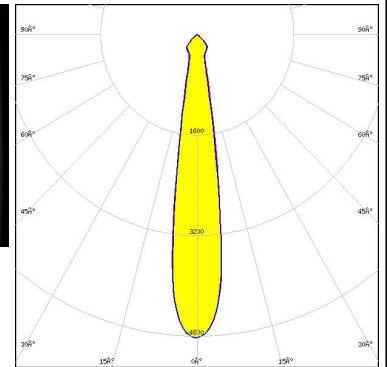

Light distribution files

OPTICAL RESULTS (SIMULATED):

bridgelux.

LED V10 Gen6
FWHM / FWTM 15.0° / 32.0°
Efficiency %
LEDs/each optic 1
Light colour/type White
Required components:
F14988_HEKLA-SOCKET-E

bridgelux.

LED V10 Gen6
FWHM / FWTM 15.0°
Efficiency 0 %
LEDs/each optic 1
Light colour/type White
Required components:
F14988_HEKLA-SOCKET-E

bridgelux.

LED V13 Gen6
FWHM / FWTM 24.0° / 70.0°
Efficiency 92 %
Peak intensity 2.8 cd/lm
LEDs/each optic 1
Light colour/type White
Required components:
F14988_HEKLA-SOCKET-E

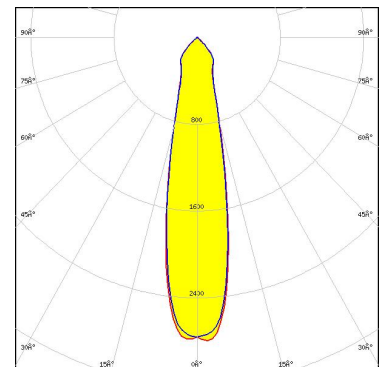

Light distribution files

OPTICAL RESULTS (SIMULATED):



LED V8 Gen6
 FWHM / FWTM 15.0° / 32.0°
 Efficiency 0 %
 LEDs/each optic 1
 Light colour/type White
 Required components:
 F15253_HEKLA-SOCKET-A



LED V8 Gen7
 FWHM / FWTM 14.0° / 28.0°
 Efficiency 92 %
 Peak intensity 5.7 cd/lm
 LEDs/each optic 1
 Light colour/type White
 Required components:
 F15253_HEKLA-SOCKET-A

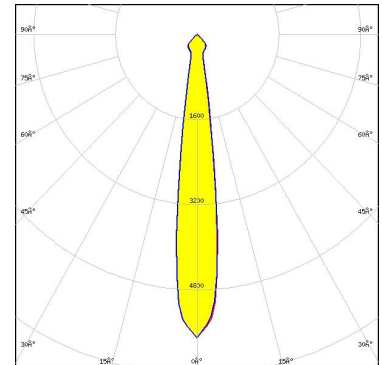

Light distribution files



LED Vesta TW 9mm (9W) DP
 FWHM / FWTM 18.0° / 45.0°
 Efficiency 87 %
 Peak intensity 3.5 cd/lm
 LEDs/each optic 1
 Light colour/type White
 Required components:
 C16142_HEKLA-SOCKET-K
 C14658_BARBARA-RZ-LENS

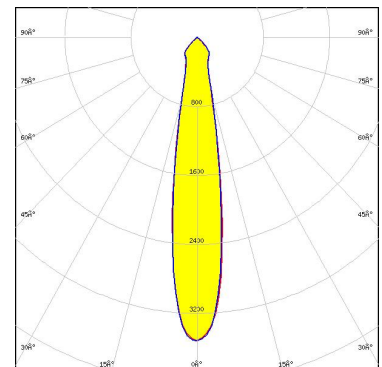

Light distribution files

Bender Wirth: 489 Typ L8

OPTICAL RESULTS (SIMULATED):

CITIZEN

LED CLL02x/CLU02x (LES10)
 FWHM / FWTM 18.0° / 36.0°
 Efficiency 92 %
 Peak intensity 4.3 cd/lm
 LEDs/each optic 1
 Light colour/type White
 Required components:
 F15255_HEKLA-SOCKET-C

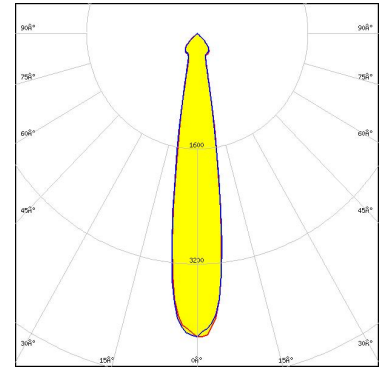

Light distribution files



LED CMT14xx
 FWHM / FWTM 17.0° / 35.0°
 Efficiency 90 %
 Peak intensity 4.2 cd/lm
 LEDs/each optic 1
 Light colour/type White
 Required components:
 F15255_HEKLA-SOCKET-C

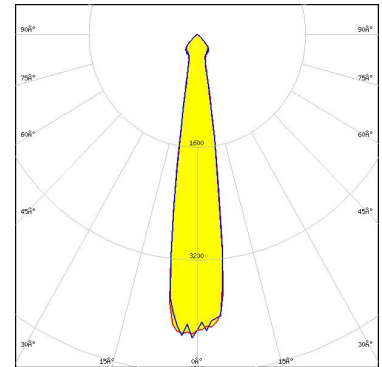

Light distribution files



LED CXA/B 15xx
 FWHM / FWTM 15.0°
 Efficiency 0 %
 LEDs/each optic 1
 Light colour/type White
 Required components:
 F15256_HEKLA-SOCKET-D

OPTICAL RESULTS (SIMULATED):



LED CXA/B 1816 & CXA/B 1820 & CXA 1850
FWHM / FWTM 22.0°
Efficiency %
LEDs/each optic 1
Light colour/type White
Required components:
F15254_HEKLA-SOCKET-B



LED CXA/B 1816 & CXA/B 1820 & CXA 1850
FWHM / FWTM 22.0°
Efficiency 0 %
LEDs/each optic 1
Light colour/type White
Required components:
F15254_HEKLA-SOCKET-B



LED CXM-3
FWHM / FWTM 6.0° / 12.0°
Efficiency 93 %
Peak intensity 25.2 cd/lm
LEDs/each optic 1
Light colour/type White
Required components:
C16142_HEKLA-SOCKET-K

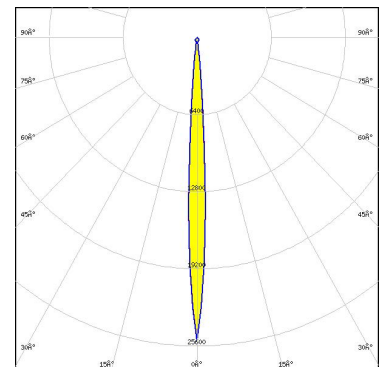

Bender Wirth: 434 Typ L8

Light distribution files

OPTICAL RESULTS (SIMULATED):

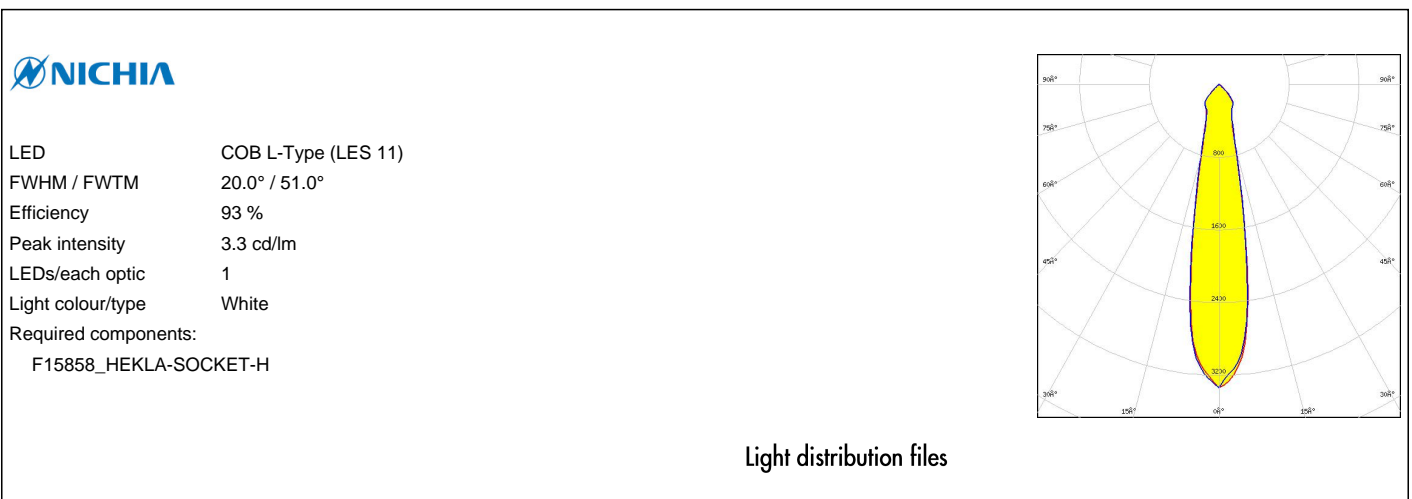
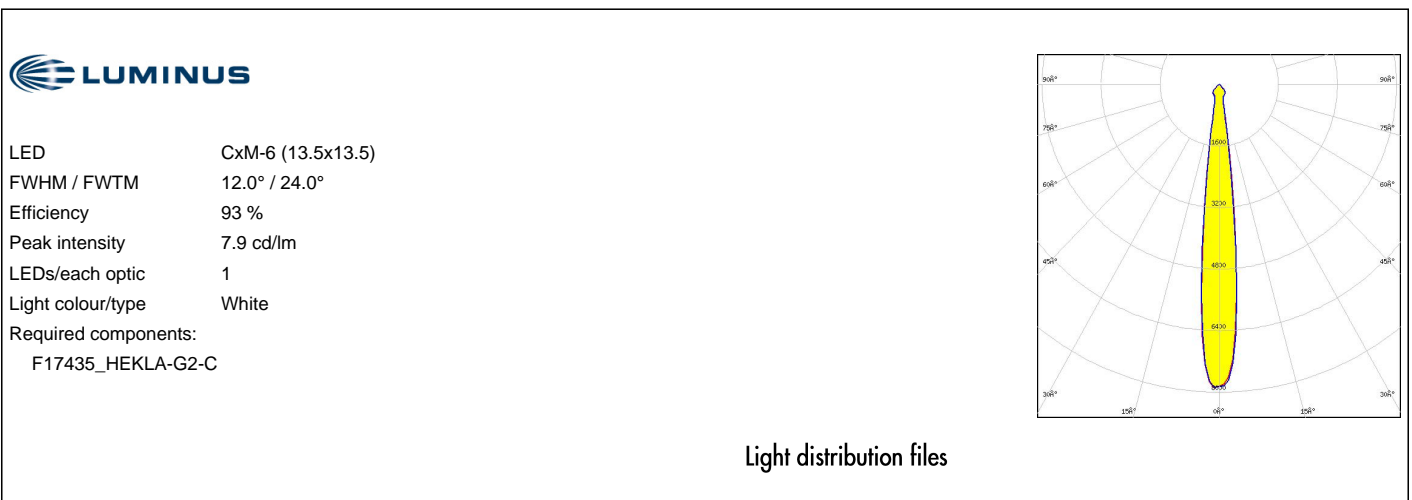
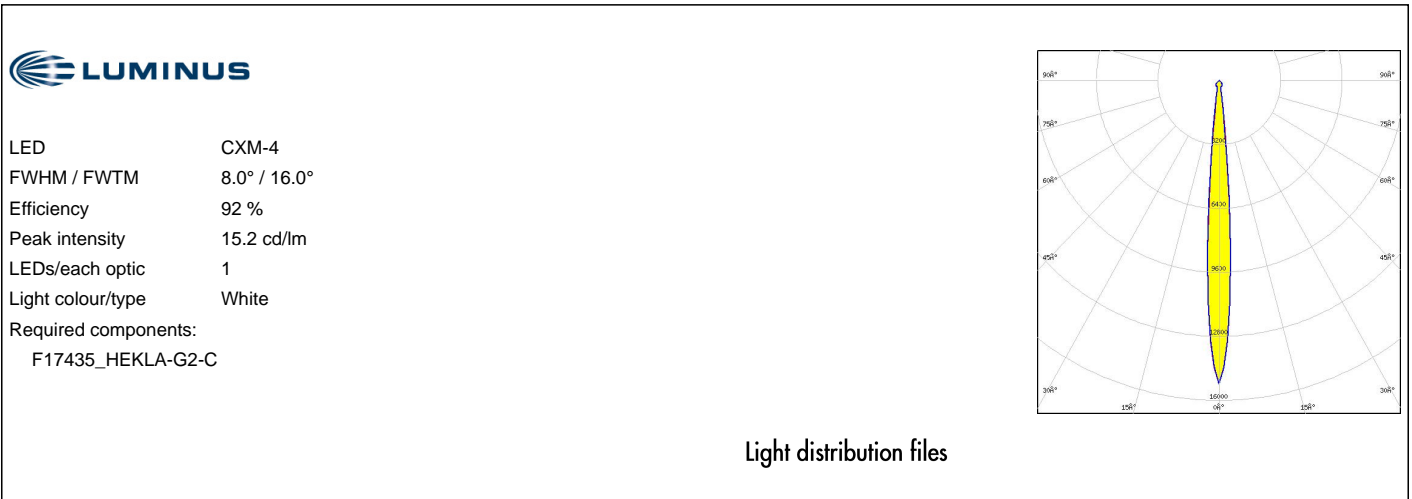

OPTICAL RESULTS (SIMULATED):

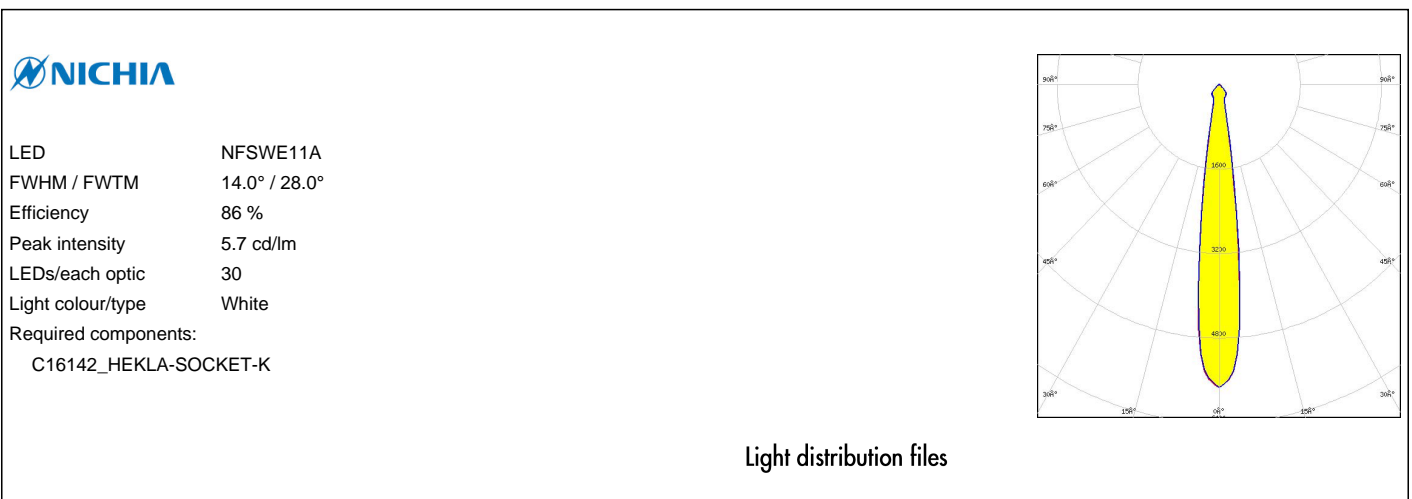
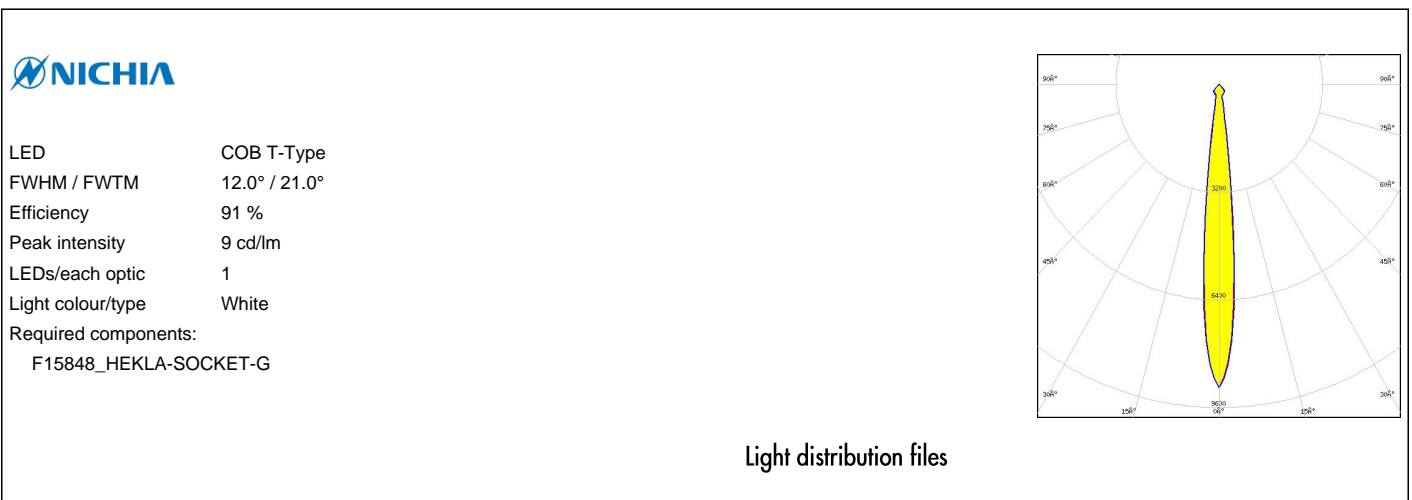
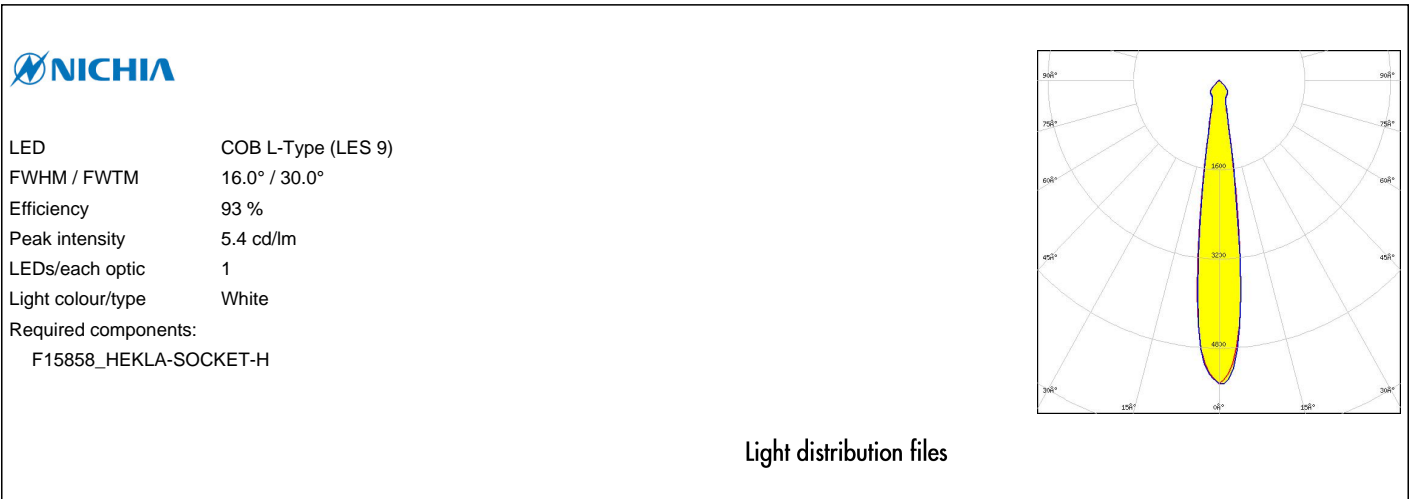

OPTICAL RESULTS (SIMULATED):

OSRAM
Opto Semiconductors

LED Soleriq S13 19x19
 FWHM / FWTM 23.9° / 70.4°
 Efficiency 93 %
 Peak intensity 2.7 cd/lm
 LEDs/each optic 1
 Light colour/type White
 Required components:
 F15859_HEKLA-SOCKET-I

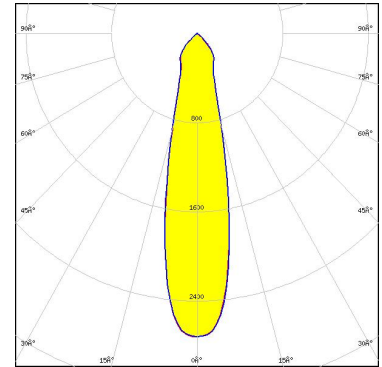

Light distribution files

OSRAM
Opto Semiconductors

LED Soleriq S9
 FWHM / FWTM 17.4° / 36.5°
 Efficiency 93 %
 Peak intensity 4.4 cd/lm
 LEDs/each optic 1
 Light colour/type White
 Required components:
 F15255_HEKLA-SOCKET-C

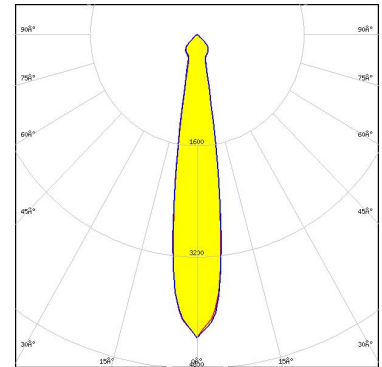

Light distribution files

SAMSUNG

LED LC016D / LC019D / LC026D / LC033D
 FWHM / FWTM 29.0° / 82.1°
 Efficiency 88 %
 Peak intensity 1.9 cd/lm
 LEDs/each optic 1
 Light colour/type White
 Required components:
 F15859_HEKLA-SOCKET-I

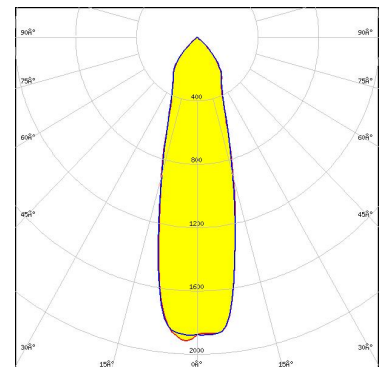

Light distribution files

GENERAL INFORMATION:

NOTE: The typical beam angle will be changed by different color, chip size and chip position tolerance. The typical total beam angle is the full angle measured where the luminous intensity is half of the peak value.

Due to use of high power COB's with this product, special attention to proper thermal design is highly recommended. LEDiL has no liability for direct, indirect or consecutive damages arising from the LEDiL products being used outside of the recommended temperature range.

MATERIALS:

As part of our continuous research and improvement processes, and to ensure the best possible quality and availability of our products, LEDiL reserves the right to change material grades without notice.

PRODUCT DATA USER AGREEMENT AND DISCLAIMER:

The measured data in the provided downloadable LEDiL Product Datasheets and Mechanical 2D-Drawings is rounded and provided as reference for planning. LEDiL Oy's optical specifications have been verified by conducting performance testing of the products in accordance with the company's quality system. The reported data are averaged results of multiple measurements with typical variation. LEDiL Oy reserves the right to without prior notification make changes and improvements to its products.

LEDiL Oy assumes neither warranty, nor guarantee nor any other liability of any kind for the contents and correctness of the provided data. The provided data has been generated with highest diligence but the provided data may in reality not represent the complete possible variation range of all intrinsic parameters. Therefore, in certain cases a deviation from the provided data could occur.

LEDiL Oy reserves the right to undertake technical changes of its products without further notification which could lead to changes in the provided data. LEDiL Oy assumes no liability of any kind for the possible deviation from any provided data or any other damage resulting from the usage of the provided data.

The user agrees to this disclaimer and user agreement with the download or usage of the provided files.

LEDiL Oy

Joensuunkatu 13
FI-24240 SALO
Finland

LEDiL Inc.

228 West Page Street
Suite D
Sycamore IL 60178
USA

Ledil Optics Technology (Shenzhen) Co., Ltd.

405 , Block B
Casic Motor Building
Shenzhen 518057
P.R.CHINA

Local sales and technical support

[www.ledil.com/
where_to_buy](http://www.ledil.com/where_to_buy)

Shipping locations

Poznan, Poland
Hong Kong, China

Distribution Partners

[www.ledil.com/
where_to_buy](http://www.ledil.com/where_to_buy)