

ANGELETTE-M2

~35° medium beam

SPECIFICATION:

Dimensions	Ø 110.0 mm
Height	57.3 mm
Fastening	socket
ROHS compliant	yes ⓘ

MATERIALS:

Component	Type	Material	Colour	Finish	Coating
ANGELETTE-M2	Reflector	PC	metal		

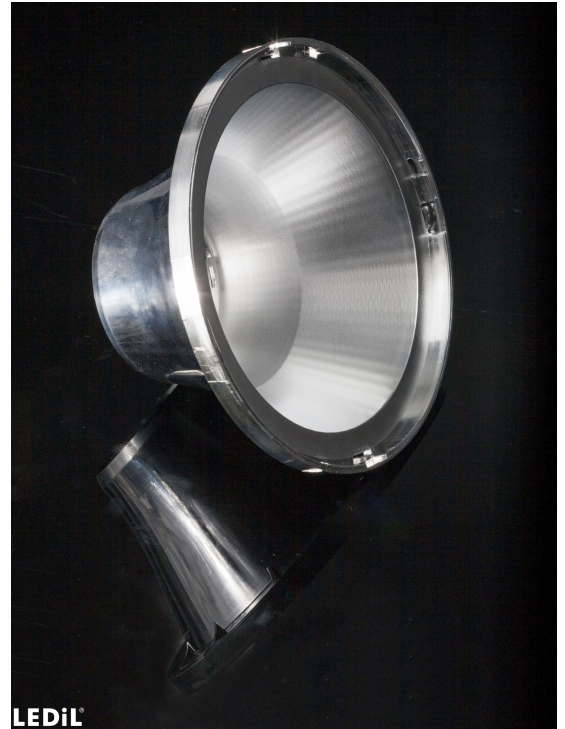

ORDERING INFORMATION:

Component	Qty in box	MOQ	MPQ	Box weight (kg)
F16010_ANGELETTE-M2 » Box size: 398 x 298 x 265 mm	120	90	30	5.2

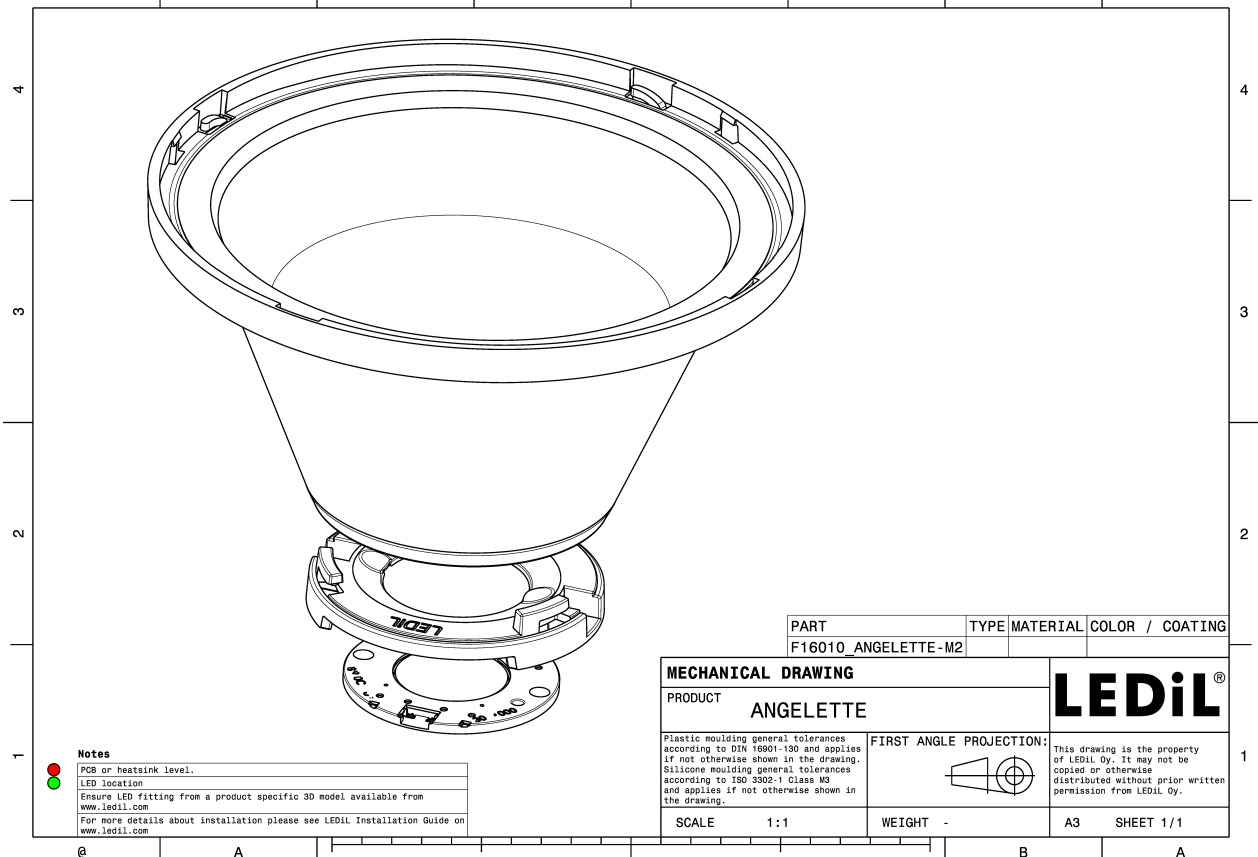
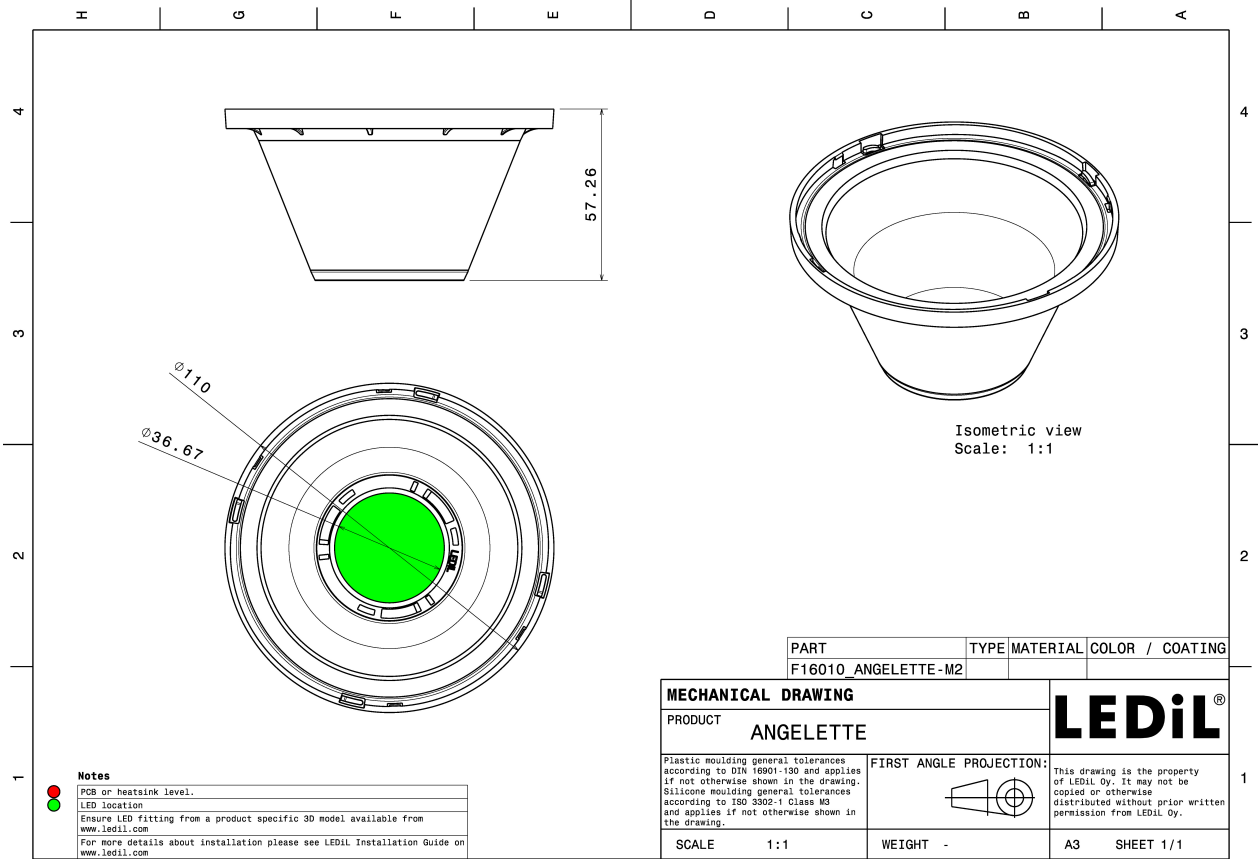

See also our general installation guide: www.ledil.com/installation_guide

OPTICAL RESULTS (MEASURED):



LED Vero SE 13
FWHM / FWTM 33.0° / 79.0°
Efficiency 87 %
Peak intensity 1.5 cd/lm
LEDs/each optic 1
Light colour/type White
Required components:
 C16402_CLAMP-VEROSE-13-18

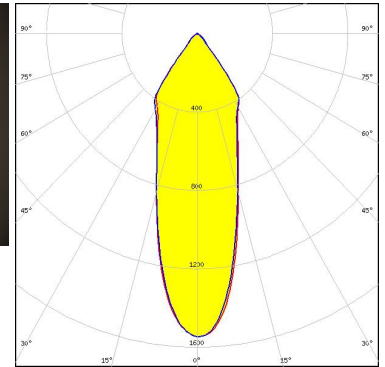
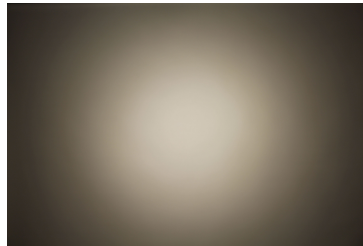

Light distribution files



LED Vero SE 18
FWHM / FWTM 38.0° / 81.0°
Efficiency 86 %
Peak intensity 1.4 cd/lm
LEDs/each optic 1
Light colour/type White
Required components:
 C16402_CLAMP-VEROSE-13-18

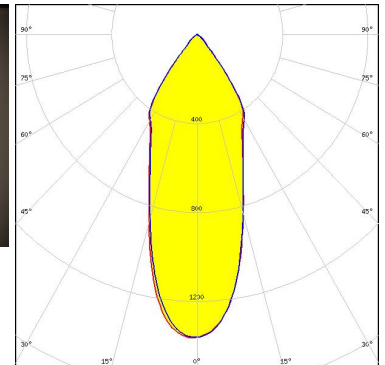
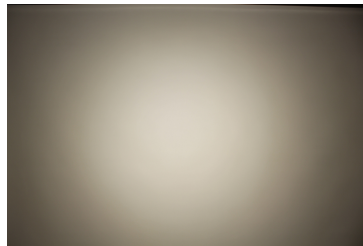

Light distribution files



LED VERO18
FWHM / FWTM 37.0° / 80.0°
Efficiency 87 %
Peak intensity 1.4 cd/lm
LEDs/each optic 1
Light colour/type White
Required components:
 C13658_CLAMP-VERO13-18

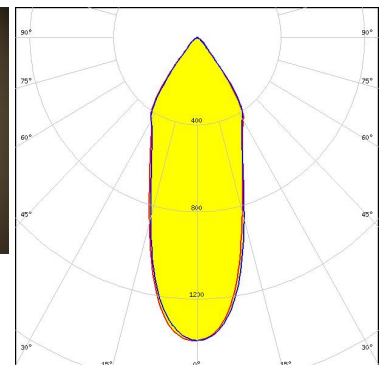
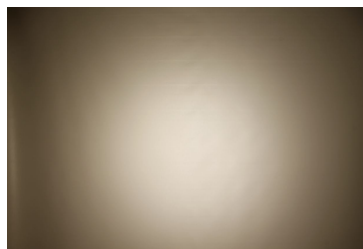

Light distribution files

OPTICAL RESULTS (MEASURED):



LED VERO18
FWHM / FWTM 38.0° / 82.0°
Efficiency 84 %
Peak intensity 1.3 cd/lm
LEDs/each optic 1
Light colour/type White
Required components:
 C13658_CLAMP-VERO13-18
 F15412_ANGELETTE-DL

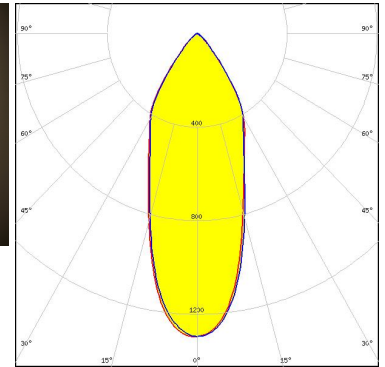
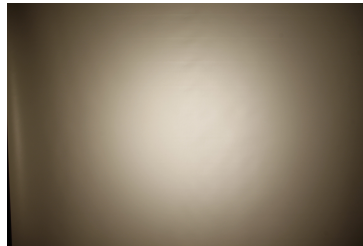

Light distribution files



LED Vesta TW 15mm DP
FWHM / FWTM 37.0° / 80.0°
Efficiency 85 %
Peak intensity 1.4 cd/lm
LEDs/each optic 1
Light colour/type White
Required components:
 C13658_CLAMP-VERO13-18
 Bender Wirth: 482 Typ L2

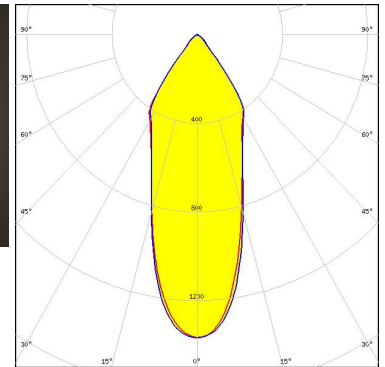
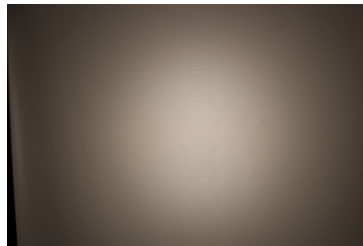

Light distribution files



LED Vesta TW 15mm DP
FWHM / FWTM 39.0° / 83.0°
Efficiency 79 %
Peak intensity 1.2 cd/lm
LEDs/each optic 1
Light colour/type White
Required components:
 C13658_CLAMP-VERO13-18
 F13671_ANGE-RZ-LENS
 Bender Wirth: 482 Typ L2

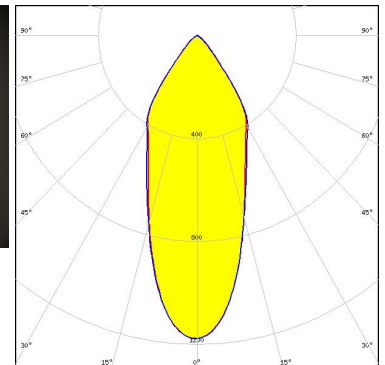
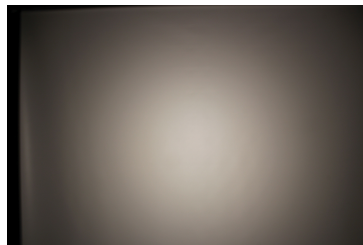

Light distribution files

OPTICAL RESULTS (MEASURED):



LED Vesta TW 18mm (31W) DP
FWHM / FWTM 41.0° / 82.0°
Efficiency 85 %
Peak intensity 1.3 cd/lm
LEDs/each optic 1
Light colour/type Tunable White
Required components:
 C13584_CLAMP-VERO29
 Bender Wirth: 483 Typ L3

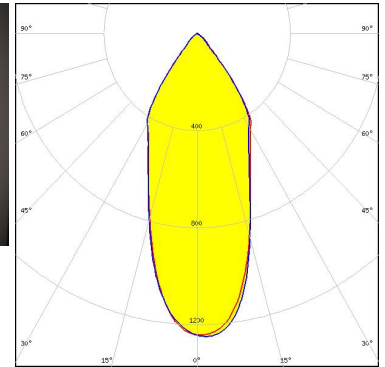
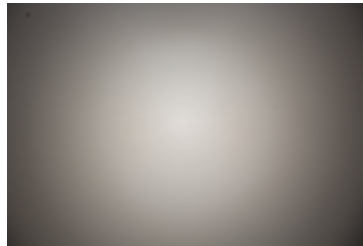

Light distribution files



LED Vesta TW 18mm (31W) DP
FWHM / FWTM 43.0° / 84.0°
Efficiency 80 %
Peak intensity 1.1 cd/lm
LEDs/each optic 1
Light colour/type Tunable White
Required components:
 C13584_CLAMP-VERO29
 F13671_ANGE-RZ-LENS
 Bender Wirth: 483 Typ L3

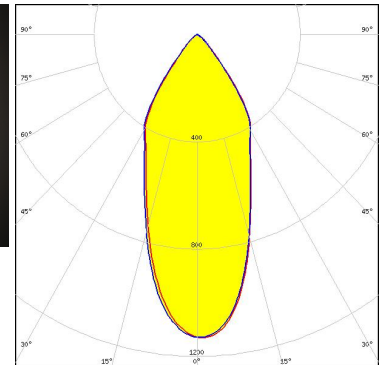
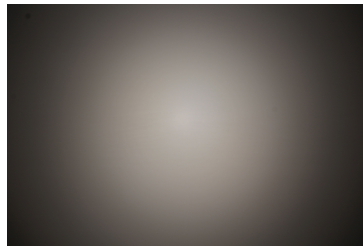

Light distribution files



LED Vesta TW 22mm DP
FWHM / FWTM 44.0° / 83.0°
Efficiency 85 %
Peak intensity 1.2 cd/lm
LEDs/each optic 1
Light colour/type Tunable White
Required components:
 C13584_CLAMP-VERO29
 Bender Wirth: 494 Typ L3

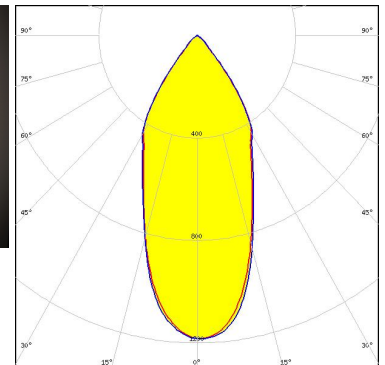
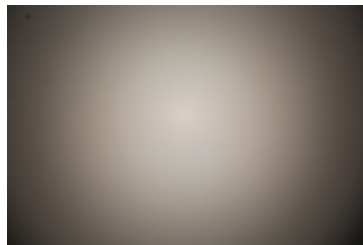

Light distribution files

OPTICAL RESULTS (MEASURED):



LED Vesta TW 22mm DP
 FWHM / FWTM 46.0° / 85.0°
 Efficiency 79 %
 Peak intensity 1.1 cd/lm
 LEDs/each optic 1
 Light colour/type Tunable White

Required components:

C13584_CLAMP-VERO29
 F13671_ANGE-RZ-LENS
 Bender Wirth: 494 Typ L3

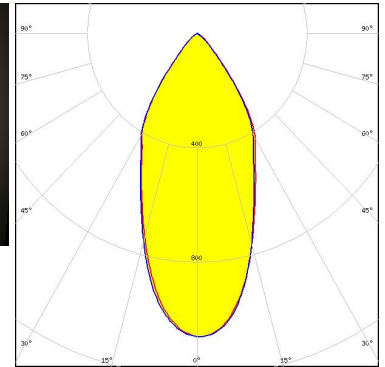
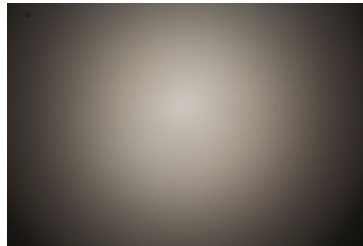

Light distribution files

CITIZEN

LED CLL03x/CLU03x
 FWHM / FWTM 37.0° / 79.0°
 Efficiency 86 %
 Peak intensity 1.4 cd/lm
 LEDs/each optic 1
 Light colour/type White

Required components:

C16791_CLAMP-Z45-A
 TE Connectivity: 2325807-3

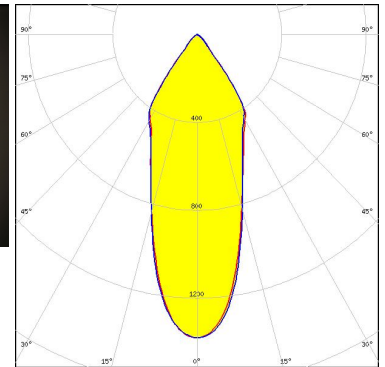
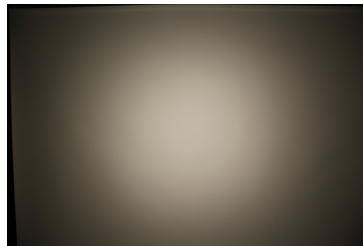

Light distribution files

CITIZEN

LED CLL03x/CLU03x
 FWHM / FWTM 39.0° / 81.0°
 Efficiency 82 %
 Peak intensity 1.2 cd/lm
 LEDs/each optic 1
 Light colour/type White

Required components:

C16791_CLAMP-Z45-A
 F13671_ANGE-RZ-LENS
 TE Connectivity: 2325807-3

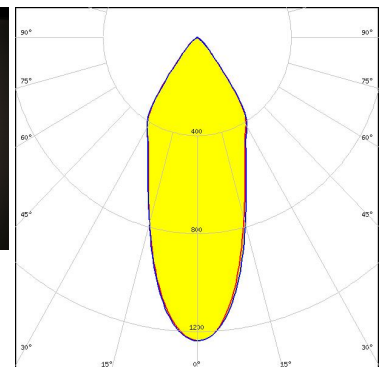

Light distribution files

OPTICAL RESULTS (MEASURED):



LED CMA1840
FWHM / FWTM 36.0° / 80.0°
Efficiency 88 %
Peak intensity 1.4 cd/lm
LEDs/each optic 1
Light colour/type White
Required components:
C14123_CLAMP-CXA15-18

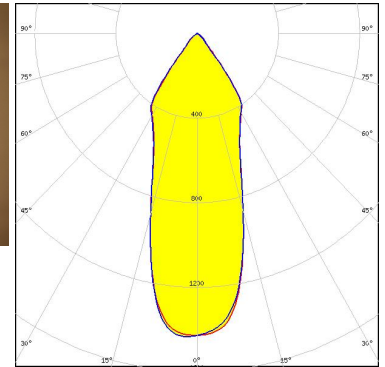

Light distribution files



LED CMA2550
FWHM / FWTM 39.0° / 81.0°
Efficiency 88 %
Peak intensity 1.3 cd/lm
LEDs/each optic 1
Light colour/type White
Required components:
C14036_CLAMP_CXA25-30

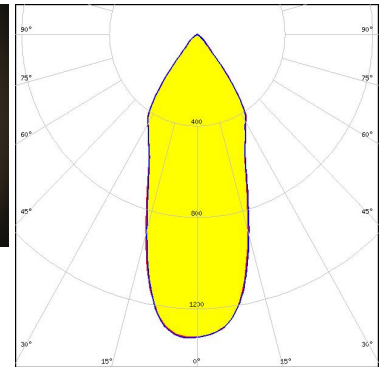
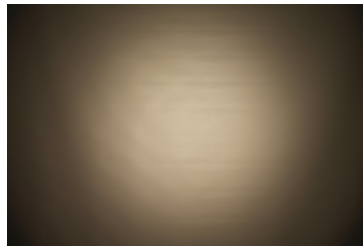

Light distribution files



LED CMT14xx
FWHM / FWTM 33.0° / 79.0°
Efficiency 87 %
Peak intensity 1.5 cd/lm
LEDs/each optic 1
Light colour/type White
Required components:
C13658_CLAMP-VERO13-18
Bender Wirth: 434 Typ L1

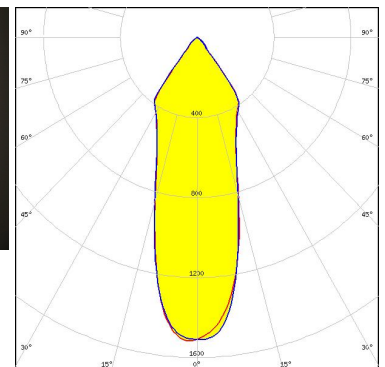
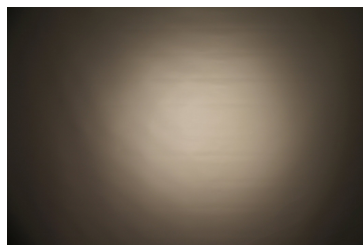

Light distribution files

OPTICAL RESULTS (MEASURED):



LED CMT19xx
FWHM / FWTM 36.0° / 80.0°
Efficiency 87 %
Peak intensity 1.4 cd/lm
LEDs/each optic 1
Light colour/type White
Required components:
C13658_CLAMP-VERO13-18
Bender Wirth: 477 Typ L1

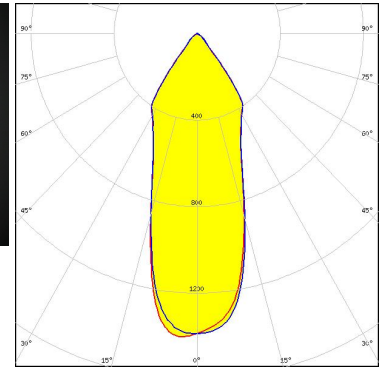
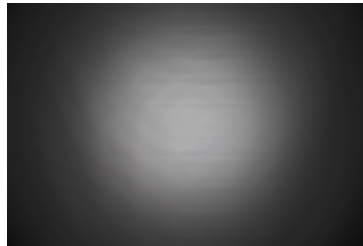

Light distribution files



LED CMT28xx
FWHM / FWTM 43.0° / 83.0°
Efficiency 87 %
Peak intensity 1.2 cd/lm
LEDs/each optic 1
Light colour/type White
Required components:
C13584_CLAMP-VERO29
Bender Wirth: 471 Typ L3

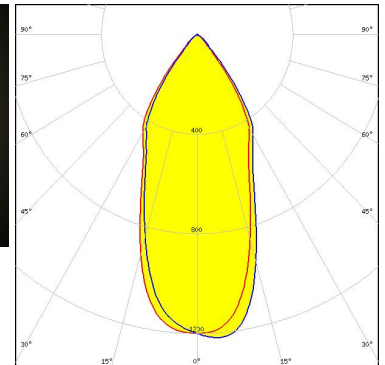
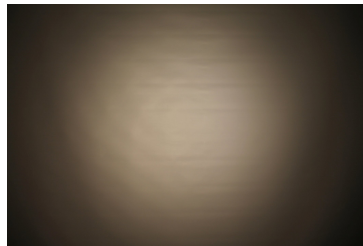

Light distribution files



LED CXA/B 1816 & CXA/B 1820 & CXA 1850
FWHM / FWTM 31.0° / 79.0°
Efficiency 88 %
Peak intensity 1.6 cd/lm
LEDs/each optic 1
Light colour/type White
Required components:
C14123_CLAMP-CXA15-18

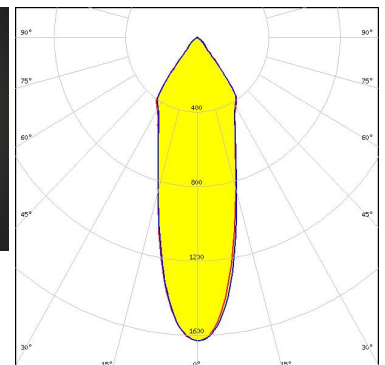
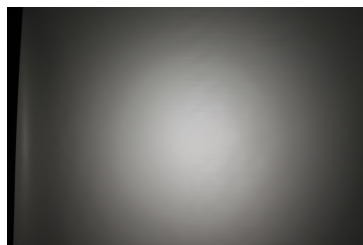

Light distribution files

OPTICAL RESULTS (MEASURED):



LED LUXEON CoB 1204/1205
FWHM / FWTM 33.0° / 78.0°
Efficiency 83 %
Peak intensity 1.5 cd/lm
LEDs/each optic 1
Light colour/type White

Required components:

F15176_ANGELETTE-LENS

TE Connectivity: 2213130-2 + OPTIC CLIP Z50 TYPE1 2213194-1

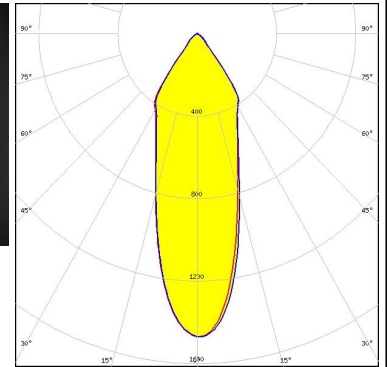
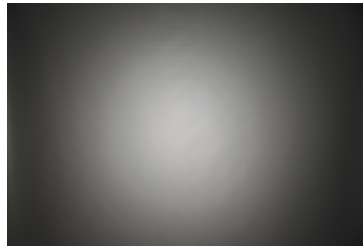

Light distribution files



LED LUXEON CoB 1204/1205
FWHM / FWTM 35.0° / 80.0°
Efficiency 82 %
Peak intensity 1.4 cd/lm
LEDs/each optic 1
Light colour/type White

Required components:

F13671_ANGE-RZ-LENS

TE Connectivity: 2213130-2 + OPTIC CLIP Z50 TYPE1 2213194-1

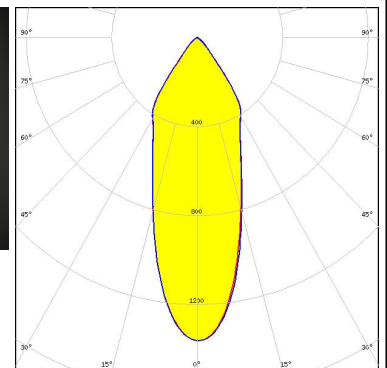
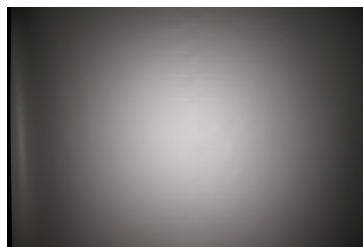

Light distribution files



LED LUXEON CoB 1204/1205
FWHM / FWTM 33.0° / 78.0°
Efficiency 86 %
Peak intensity 1.6 cd/lm
LEDs/each optic 1
Light colour/type White

Required components:

TE Connectivity: 2213130-2 + OPTIC CLIP Z50 TYPE1 2213194-1

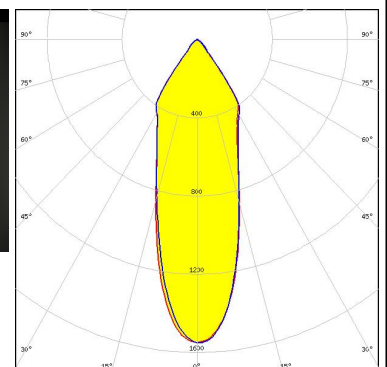

Light distribution files

OPTICAL RESULTS (MEASURED):



LED LUXEON CoB 1204/1205
 FWHM / FWTM 34.0° / 80.0°
 Efficiency 83 %
 Peak intensity 1.4 cd/lm
 LEDs/each optic 1
 Light colour/type White

Required components:

F15412_ANGELETTE-DL
 TE Connectivity: 2213130-2 + OPTIC CLIP Z50 TYPE1 2213194-1

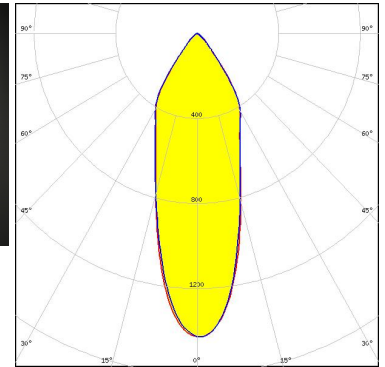
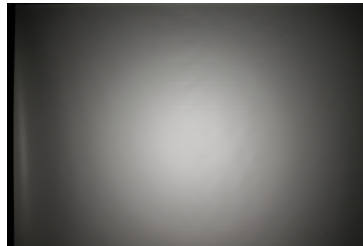

Light distribution files



LED LUXEON CoB 1204HD
 FWHM / FWTM 33.0° / 77.0°
 Efficiency 87 %
 Peak intensity 1.6 cd/lm
 LEDs/each optic 1
 Light colour/type White

Required components:

TE Connectivity: 2213382-2 + OPTIC CLIP Z50 TYPE1 2213194-1

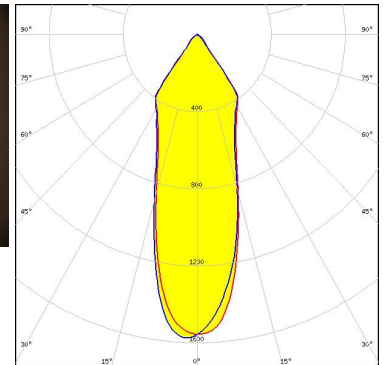
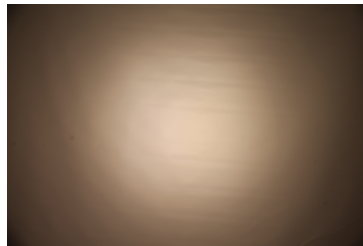

Light distribution files



LED LUXEON CoB 1205HD
 FWHM / FWTM 35.0° / 78.0°
 Efficiency 87 %
 Peak intensity 1.5 cd/lm
 LEDs/each optic 1
 Light colour/type White

Required components:

F15858_HEKLA-SOCKET-H

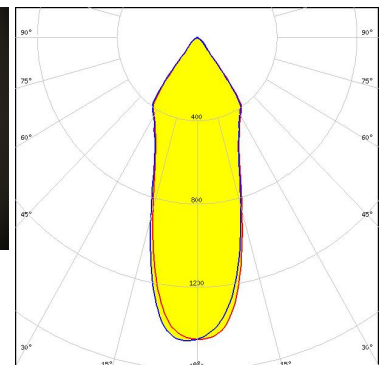
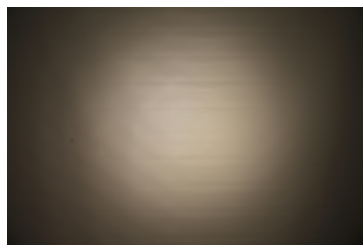

Light distribution files

OPTICAL RESULTS (MEASURED):



LED CDM-14 (Dim-To-Warm)
 FWHM / FWTM 38.0° / 82.0°
 Efficiency 78 %
 Peak intensity 1.2 cd/lm
 LEDs/each optic 1
 Light colour/type White
 Required components:
 C13658_CLAMP-VERO13-18
 F13671_ANGE-RZ-LENS
 Bender Wirth: 491 Typ L2

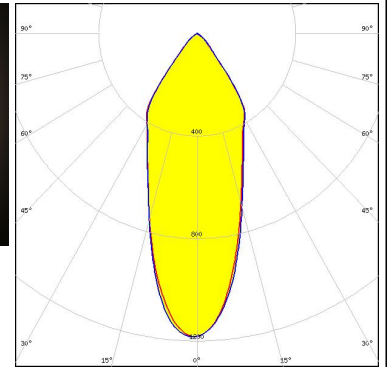
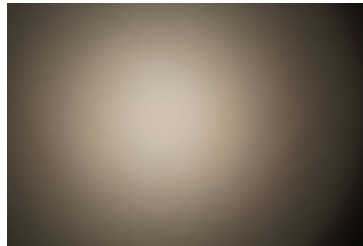

Light distribution files



LED CDM-14 (Dim-To-Warm)
 FWHM / FWTM 35.0° / 80.0°
 Efficiency 83 %
 Peak intensity 1.3 cd/lm
 LEDs/each optic 1
 Light colour/type White
 Required components:
 C13658_CLAMP-VERO13-18
 Bender Wirth: 491 Typ L2

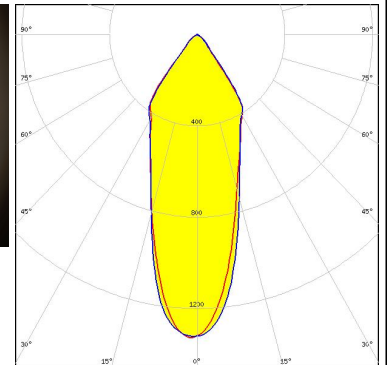
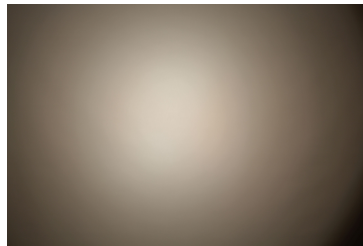

Light distribution files



LED CDM-18 (Dim-To-Warm)
 FWHM / FWTM 41.0° / 83.0°
 Efficiency 78 %
 Peak intensity 1.1 cd/lm
 LEDs/each optic 1
 Light colour/type White
 Required components:
 C13658_CLAMP-VERO13-18
 F13671_ANGE-RZ-LENS
 Bender Wirth: 491 Typ L2

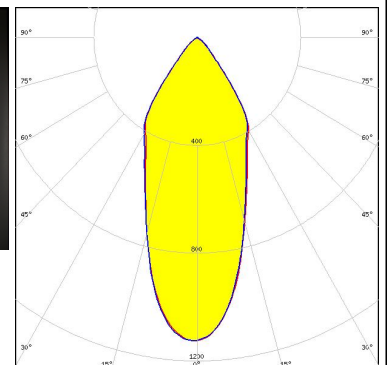
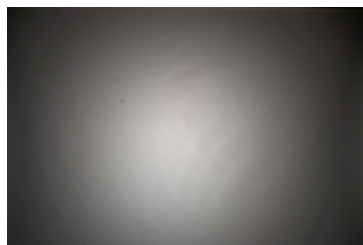

Light distribution files

OPTICAL RESULTS (MEASURED):



LED CDM-18 (Dim-To-Warm)
FWHM / FWTM 38.0° / 81.0°
Efficiency 83 %
Peak intensity 1.3 cd/lm
LEDs/each optic 1
Light colour/type White
Required components:
 C13658_CLAMP-VERO13-18
 Bender Wirth: 491 Typ L2

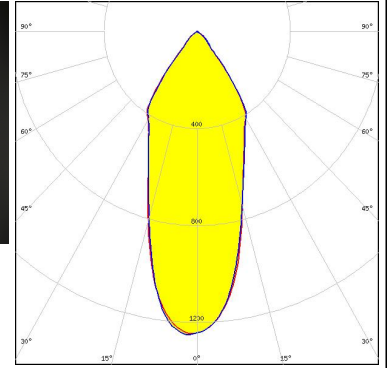
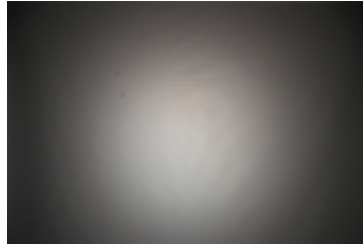

Light distribution files



LED CDM-9 (Dim-To-Warm)
FWHM / FWTM 28.0° / 77.0°
Efficiency 84 %
Peak intensity 1.7 cd/lm
LEDs/each optic 1
Light colour/type White
Required components:
 C13658_CLAMP-VERO13-18
 Bender Wirth: 490 Typ L1

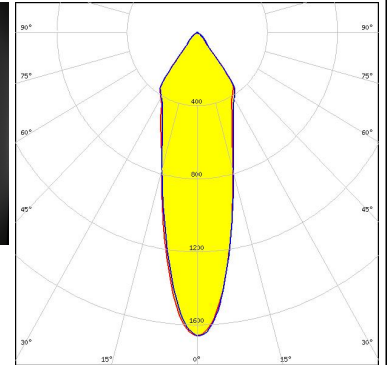

Light distribution files



LED CDM-9 (Dim-To-Warm)
FWHM / FWTM 32.0° / 79.0°
Efficiency 80 %
Peak intensity 1.4 cd/lm
LEDs/each optic 1
Light colour/type White
Required components:
 C13658_CLAMP-VERO13-18
 F13671_ANGE-RZ-LENS
 Bender Wirth: 490 Typ L1

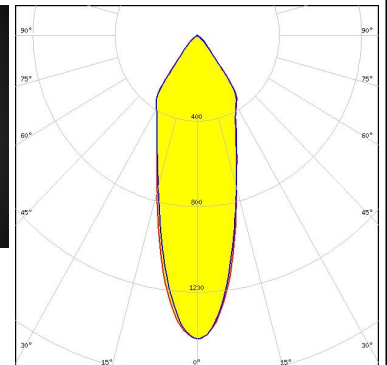
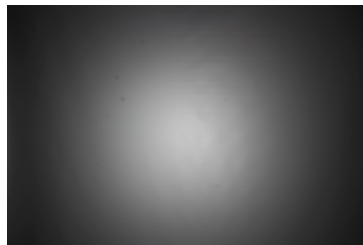

Light distribution files

OPTICAL RESULTS (MEASURED):



LED CTM-14 (Tunable White)
FWHM / FWTM 39.0° / 82.0°
Efficiency 79 %
Peak intensity 1.2 cd/lm
LEDs/each optic 1
Light colour/type White
Required components:
 C13584_CLAMP-VERO29
 F13671_ANGE-RZ-LENS
 Bender Wirth: 442 Typ L3

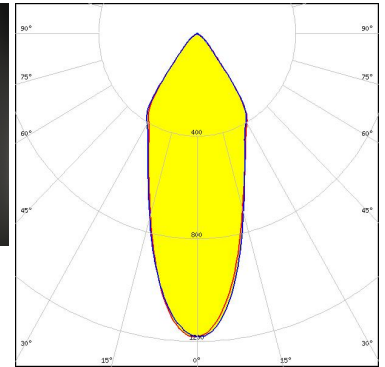
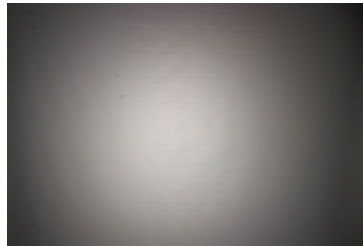

Light distribution files



LED CTM-14 (Tunable White)
FWHM / FWTM 33.0° / 79.0°
Efficiency 85 %
Peak intensity 1.5 cd/lm
LEDs/each optic 1
Light colour/type White
Required components:
 C13584_CLAMP-VERO29
 Bender Wirth: 442 Typ L3

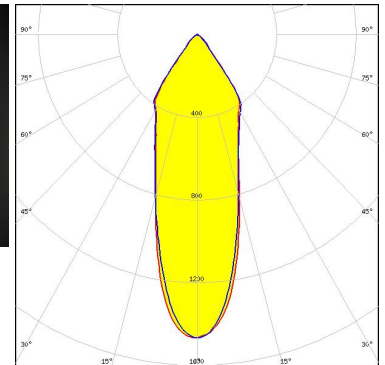
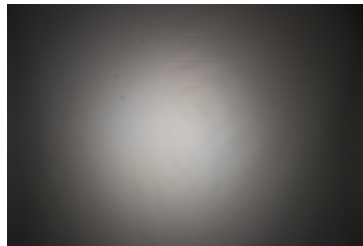

Light distribution files



LED CTM-14 RGBW
FWHM / FWTM 36.0° / 80.0°
Efficiency 82 %
Peak intensity 1.3 cd/lm
LEDs/each optic 1
Light colour/type RGBW
Required components:
 C13584_CLAMP-VERO29
 F13671_ANGE-RZ-LENS
 Bender Wirth: 500 Typ L3-1

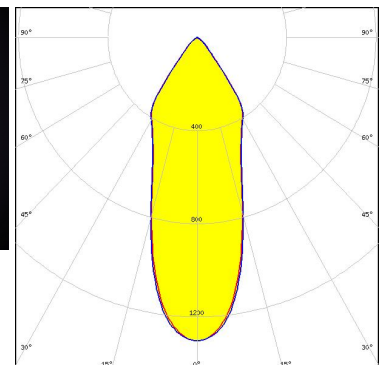
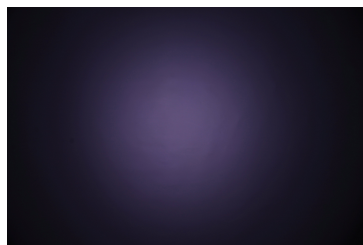

Light distribution files

OPTICAL RESULTS (MEASURED):



LED CTM-14 RGBW
FWHM / FWTM 34.0° / 78.0°
Efficiency 86 %
Peak intensity 1.5 cd/lm
LEDs/each optic 1
Light colour/type RGBW
Required components:
 C13584_CLAMP-VERO29
 F13671_ANGE-RZ-LENS
 Bender Wirth: 500 Typ L3-1

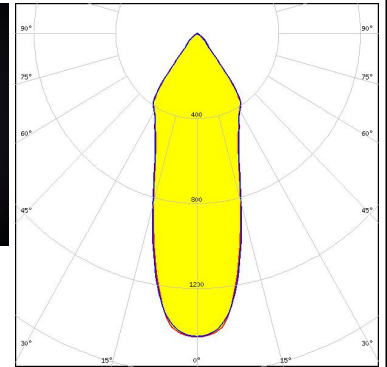
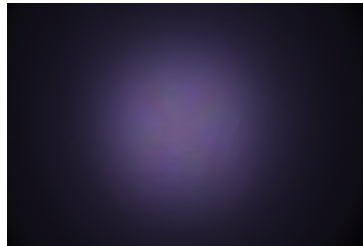

Light distribution files



LED CTM-22 (Tunable White)
FWHM / FWTM 42.0° / 83.0°
Efficiency 84 %
Peak intensity 1.2 cd/lm
LEDs/each optic 1
Light colour/type White
Required components:
 C13584_CLAMP-VERO29
 Bender Wirth: 494 Typ L3

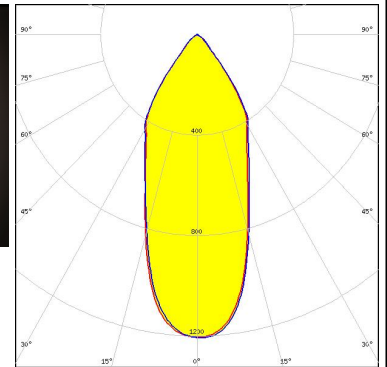
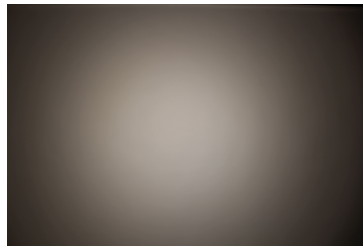

Light distribution files



LED CTM-22 (Tunable White)
FWHM / FWTM 43.0° / 84.0°
Efficiency 79 %
Peak intensity 1.1 cd/lm
LEDs/each optic 1
Light colour/type White
Required components:
 C13584_CLAMP-VERO29
 F13671_ANGE-RZ-LENS
 Bender Wirth: 494 Typ L3

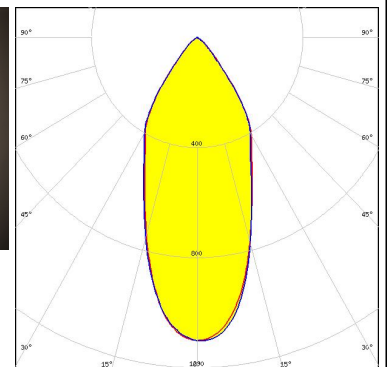
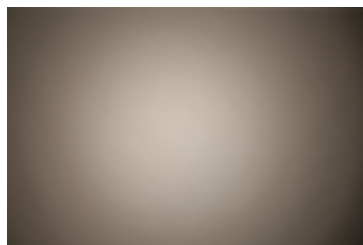

Light distribution files

OPTICAL RESULTS (MEASURED):



LED NVCWJ024Z-V1MT: COB J-Type Tunable White
 FWHM / FWTM 34.0° / 80.0°
 Efficiency 81 %
 Peak intensity 1.4 cd/lm
 LEDs/each optic 1
 Light colour/type White
 Required components:
 C13658_CLAMP-VERO13-18
 F13671_ANGE-RZ-LENS
 Bender Wirth: 498 Typ L2

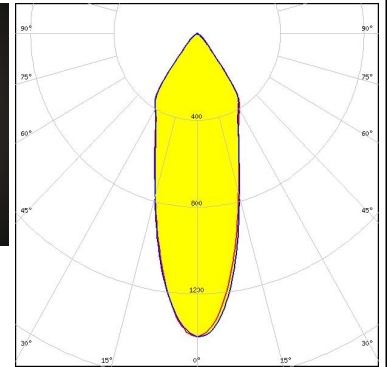

Light distribution files



LED NVCWJ024Z-V1MT: COB J-Type Tunable White
 FWHM / FWTM 31.0° / 78.0°
 Efficiency 86 %
 Peak intensity 1.6 cd/lm
 LEDs/each optic 1
 Light colour/type White
 Required components:
 C13658_CLAMP-VERO13-18
 Bender Wirth: 498 Typ L2

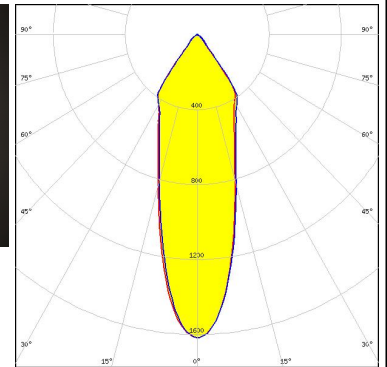
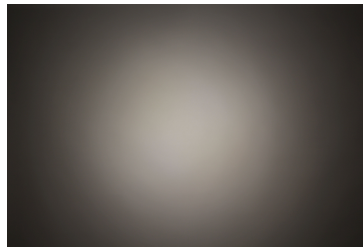

Light distribution files



LED PrevaLED Core G7 L15 H1
 FWHM / FWTM 40.0° / 81.0°
 Efficiency 82 %
 Peak intensity 1.2 cd/lm
 LEDs/each optic 1
 Light colour/type White
 Required components:
 C16685_CLAMP-PRV-A
 F13671_ANGE-RZ-LENS

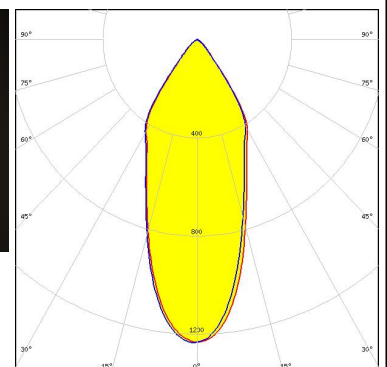
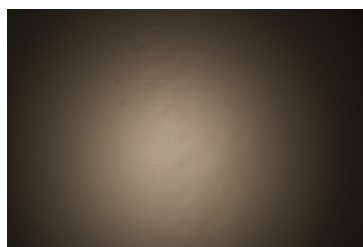

Light distribution files

OPTICAL RESULTS (MEASURED):

OSRAM

LED PrevaLED Core G7 L15 H1
FWHM / FWTM 38.0° / 79.0°
Efficiency 86 %
Peak intensity 1.4 cd/lm
LEDs/each optic 1
Light colour/type White
Required components:
C16685_CLAMP-PRV-A

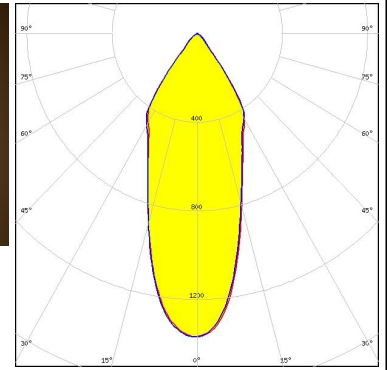

Light distribution files

PHILIPS

LED Fortimo SLM L13 CoB
FWHM / FWTM 38.0° / 81.0°
Efficiency 81 %
Peak intensity 1.3 cd/lm
LEDs/each optic 1
Light colour/type White
Required components:
F13671_ANGE-RZ-LENS
TE Connectivity: 2213130-2 + OPTIC CLIP Z50 TYPE1 2213194-1



Light distribution files

PHILIPS

LED Fortimo SLM L13 CoB
FWHM / FWTM 36.0° / 79.0°
Efficiency 87 %
Peak intensity 1.4 cd/lm
LEDs/each optic 1
Light colour/type White
Required components:
TE Connectivity: 2213130-2 + OPTIC CLIP Z50 TYPE1 2213194-1

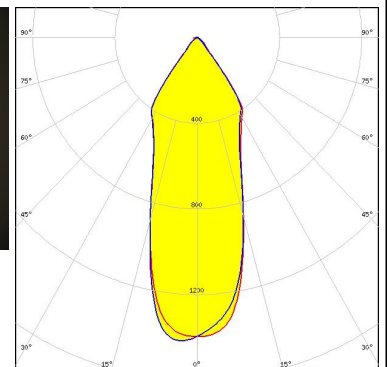
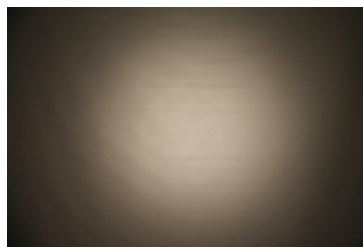

Light distribution files

OPTICAL RESULTS (MEASURED):

PHILIPS

LED Fortimo SLM L15 CoB
FWHM / FWTM 38.0° / 80.0°
Efficiency 87 %
Peak intensity 1.3 cd/lm
LEDs/each optic 1
Light colour/type White

Required components:

TE Connectivity: 2213130-2 + OPTIC CLIP Z50 TYPE1 2213194-1

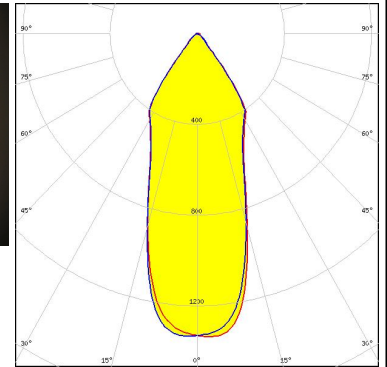

Light distribution files

PHILIPS

LED Fortimo SLM L15 CoB
FWHM / FWTM 39.0° / 82.0°
Efficiency 82 %
Peak intensity 1.2 cd/lm
LEDs/each optic 1
Light colour/type White

Required components:

F13671_ANGE-RZ-LENS
TE Connectivity: 2213130-2 + OPTIC CLIP Z50 TYPE1 2213194-1

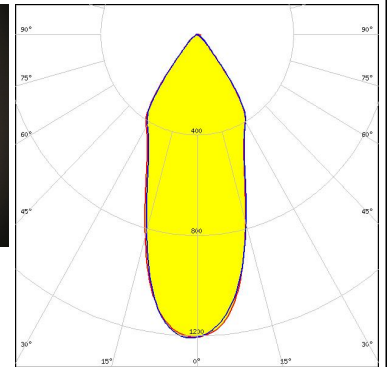
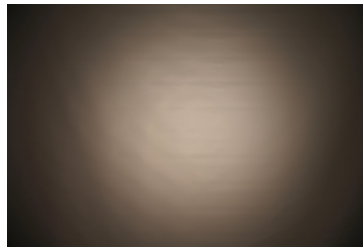

Light distribution files

SAMSUNG

LED LC035T (Tunable white)
FWHM / FWTM 47.0° / 86.0°
Efficiency 79 %
Peak intensity 1 cd/lm
LEDs/each optic 1
Light colour/type Tunable White

Required components:

C13584_CLAMP-VERO29
F13671_ANGE-RZ-LENS
Bender Wirth: 502 Typ L3

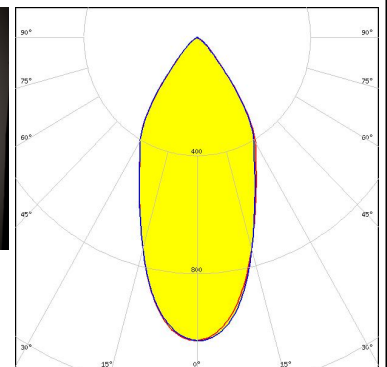
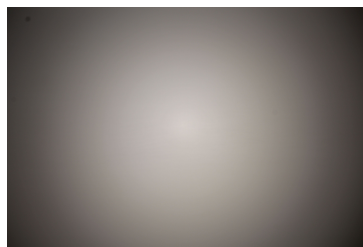

Light distribution files

OPTICAL RESULTS (MEASURED):

SAMSUNG

LED LC035T (Tunable white)
FWHM / FWTM 44.0° / 83.0°
Efficiency 85 %
Peak intensity 1.2 cd/lm
LEDs/each optic 1
Light colour/type Tunable White
Required components:
C13584_CLAMP-VERO29
Bender Wirth: 502 Typ L3

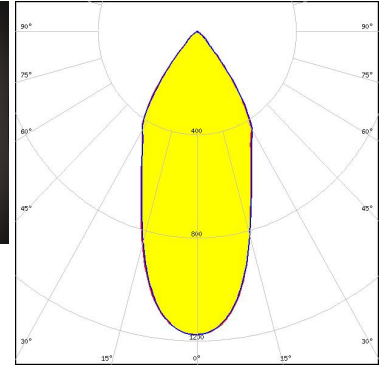

Light distribution files

XICATO

LED XTM - 19mm LES
FWHM / FWTM 37.0° / 80.0°
Efficiency 88 %
Peak intensity 1.4 cd/lm
LEDs/each optic 1
Light colour/type White
Required components:
C16491_XTM-ADAPTER-50-A

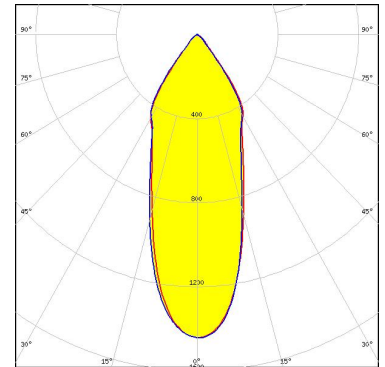

Light distribution files

GENERAL INFORMATION:

NOTE: The typical beam angle will be changed by different color, chip size and chip position tolerance. The typical total beam angle is the full angle measured where the luminous intensity is half of the peak value.

Due to use of high power COB's with this product, special attention to proper thermal design is highly recommended. LEDiL has no liability for direct, indirect or consecutive damages arising from the LEDiL products being used outside of the recommended temperature range.

MATERIALS:

As part of our continuous research and improvement processes, and to ensure the best possible quality and availability of our products, LEDiL reserves the right to change material grades without notice.

PRODUCT DATA USER AGREEMENT AND DISCLAIMER:

The measured data in the provided downloadable LEDiL Product Datasheets and Mechanical 2D-Drawings is rounded and provided as reference for planning. LEDiL Oy's optical specifications have been verified by conducting performance testing of the products in accordance with the company's quality system. The reported data are averaged results of multiple measurements with typical variation. LEDiL Oy reserves the right to without prior notification make changes and improvements to its products.

LEDiL Oy assumes neither warranty, nor guarantee nor any other liability of any kind for the contents and correctness of the provided data. The provided data has been generated with highest diligence but the provided data may in reality not represent the complete possible variation range of all intrinsic parameters. Therefore, in certain cases a deviation from the provided data could occur.

LEDiL Oy reserves the right to undertake technical changes of its products without further notification which could lead to changes in the provided data. LEDiL Oy assumes no liability of any kind for the possible deviation from any provided data or any other damage resulting from the usage of the provided data.

The user agrees to this disclaimer and user agreement with the download or usage of the provided files.

LEDiL Oy

Joensuunkatu 13
FI-24240 SALO
Finland

LEDiL Inc.

228 West Page Street
Suite D
Sycamore IL 60178
USA

Ledil Optics Technology (Shenzhen) Co., Ltd.

405 , Block B
Casic Motor Building
Shenzhen 518057
P.R.CHINA

Local sales and technical support

[www.ledil.com/
where_to_buy](http://www.ledil.com/where_to_buy)

Shipping locations

Poznan, Poland
Hong Kong, China

Distribution Partners

[www.ledil.com/
where_to_buy](http://www.ledil.com/where_to_buy)