

LENINA-S

~19° spot beam

SPECIFICATION:

Dimensions	Ø 74.0 mm
Height	40 mm
ROHS compliant	yes ⓘ

MATERIALS:

Component	Type	Material	Colour	Finish	Coating
LENINA-S	Reflector	PC	metal		lacquer



ORDERING INFORMATION:

Component	Qty in box	MOQ	MPQ	Box weight (kg)
C12597_LENINA-S » Box size: 476 x 273 x 197 mm	60	120	60	2.0

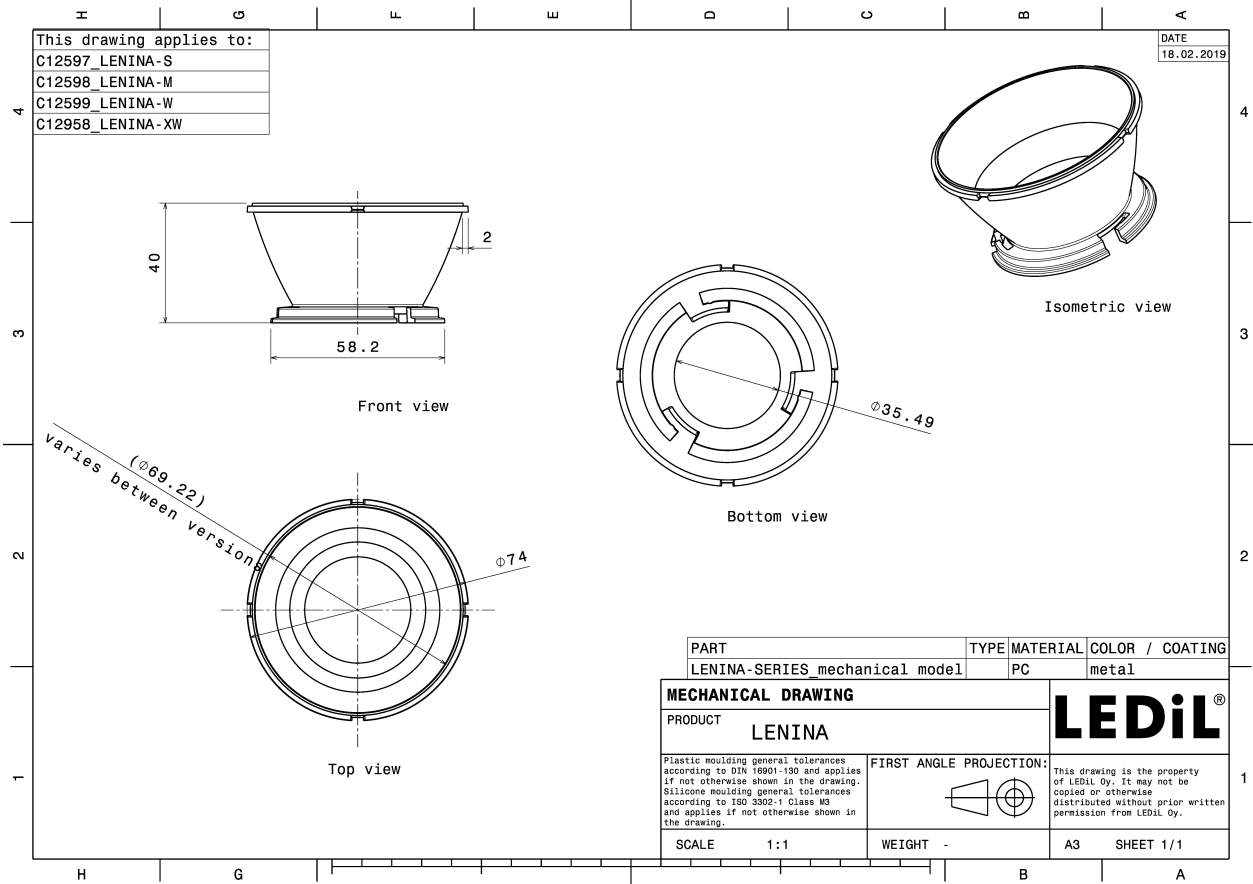

See also our general installation guide: www.ledil.com/installation_guide

OPTICAL RESULTS (MEASURED):

bridgelux

LED BXRA ES Rectangle
FWHM / FWTM 15.0° / 36.0°
Efficiency 88 %
LEDs/each optic 1
Light colour/type White
Required components:
C12153_LENINA-STD-BASE-BXRA

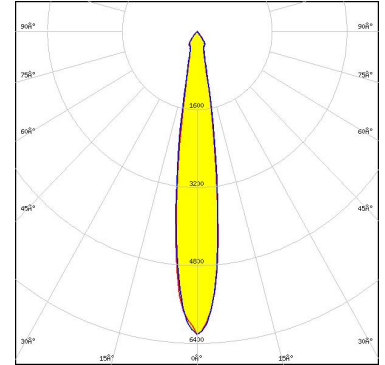

Light distribution files

bridgelux

LED BXRA ES Rectangle
FWHM / FWTM 20.0° / 60.0°
Efficiency 80 %
LEDs/each optic 1
Light colour/type White
Required components:
C12153_LENINA-STD-BASE-BXRA
C12606_LENINA-DL

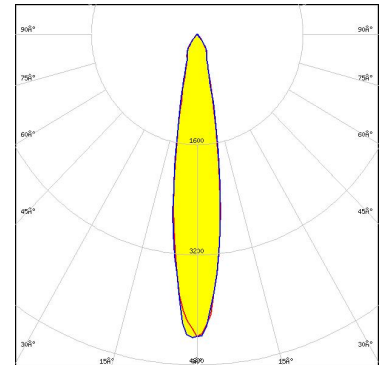

Light distribution files

bridgelux

LED BXRA RS
FWHM / FWTM 28.0° / 70.0°
Efficiency 89 %
Peak intensity 2.3 cd/lm
LEDs/each optic 1
Light colour/type White
Required components:
C12229_LENINA-STD-BASE-RS

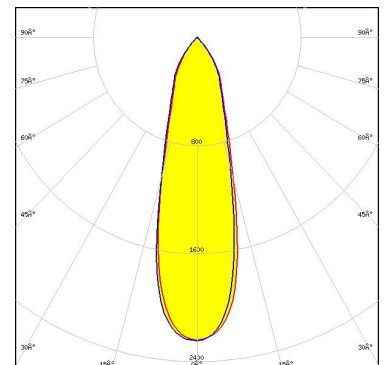

Light distribution files

OPTICAL RESULTS (MEASURED):



LED BXRA RS
FWHM / FWTM 32.0° / 72.0°
Efficiency 81 %
Peak intensity 2 cd/lm
LEDs/each optic 1
Light colour/type White
Required components:
 C12229_LENINA-STD-BASE-RS
 C12606_LENINA-DL

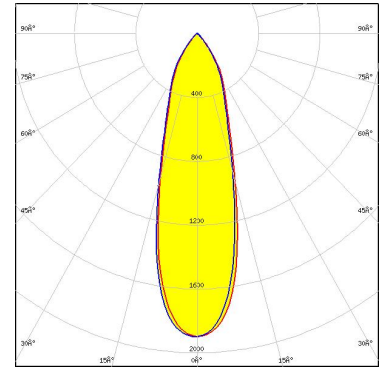

Light distribution files



LED V10 Gen6
FWHM / FWTM 13.0° / 30.0°
Efficiency 83 %
Peak intensity 7.2 cd/lm
LEDs/each optic 1
Light colour/type White
Required components:
 C13186_LENINA-STD-BASE-CXA15
 C12606_LENINA-DL

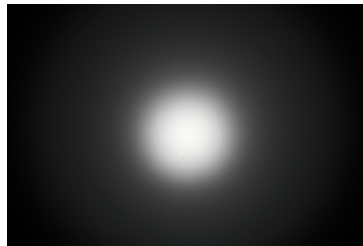

Light distribution files



LED Vero SE 29
FWHM / FWTM 38.0° / 76.0°
Efficiency 92 %
Peak intensity 1.7 cd/lm
LEDs/each optic 1
Light colour/type White
Required components:
 C15083_LENINA-STD-BASE-VERO29

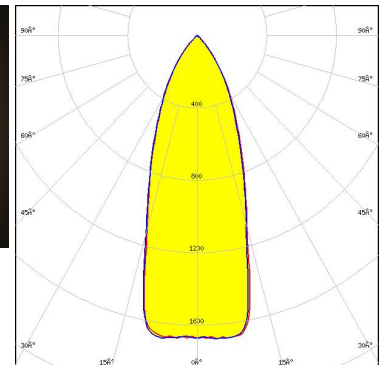
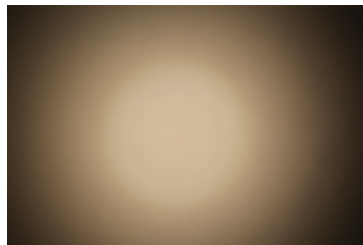

Light distribution files

OPTICAL RESULTS (MEASURED):



LED VERO13
FWHM / FWTM 15.0° / 29.0°
Efficiency 91 %
Peak intensity 6.8 cd/lm
LEDs/each optic 1
Light colour/type White
Required components:
 C13868_LENINA-STD-BASE-VERO13-18

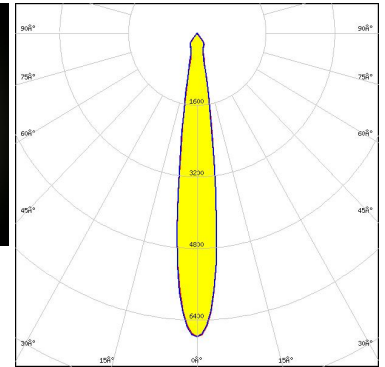

Light distribution files



LED VERO13
FWHM / FWTM 16.0° / 35.0°
Efficiency 86 %
Peak intensity 5.1 cd/lm
LEDs/each optic 1
Light colour/type White
Required components:
 C13868_LENINA-STD-BASE-VERO13-18
 C12606_LENINA-DL

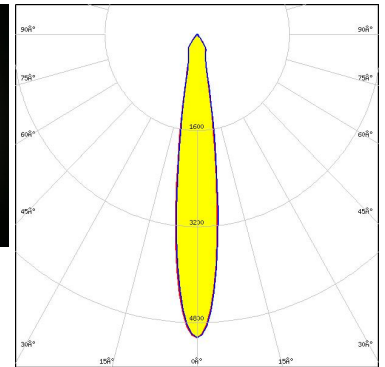

Light distribution files



LED VERO18
FWHM / FWTM 21.0° / 52.0°
Efficiency 90 %
Peak intensity 3.7 cd/lm
LEDs/each optic 1
Light colour/type White
Required components:
 C13868_LENINA-STD-BASE-VERO13-18

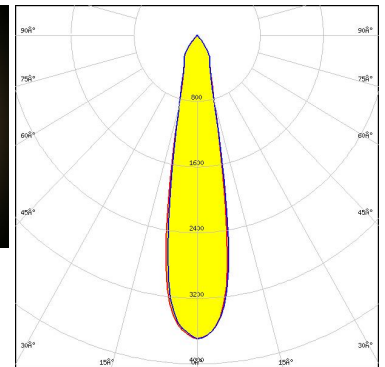

Light distribution files

OPTICAL RESULTS (MEASURED):



LED VERO18
 FWHM / FWTM 22.0° / 60.0°
 Efficiency 86 %
 Peak intensity 3.1 cd/lm
 LEDs/each optic 1
 Light colour/type White

Required components:

C13868_LENINA-STD-BASE-VERO13-18
 C12606_LENINA-DL

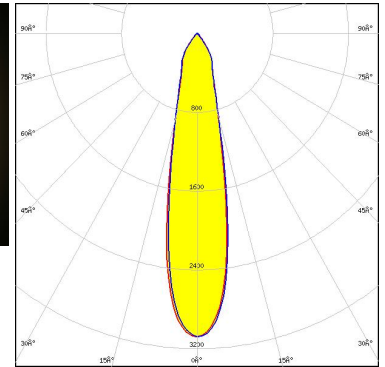

Light distribution files



LED VERO29
 FWHM / FWTM 40.0° / 78.0°
 Efficiency 85 %
 Peak intensity 1.5 cd/lm
 LEDs/each optic 1
 Light colour/type White

Required components:

C13867_LENINA-STD-BASE-VERO29
 C12606_LENINA-DL

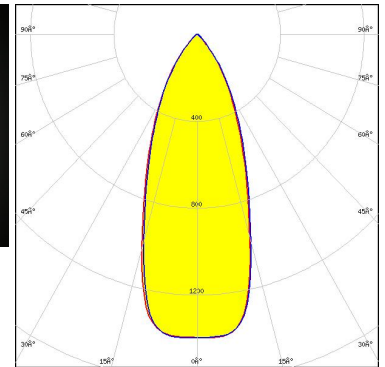
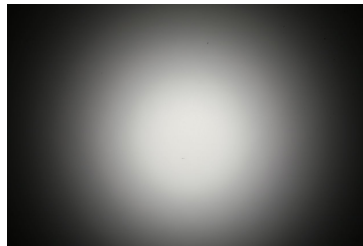

Light distribution files



LED VERO29
 FWHM / FWTM 40.0° / 78.0°
 Efficiency 89 %
 Peak intensity 1.6 cd/lm
 LEDs/each optic 1
 Light colour/type White

Required components:

C13867_LENINA-STD-BASE-VERO29

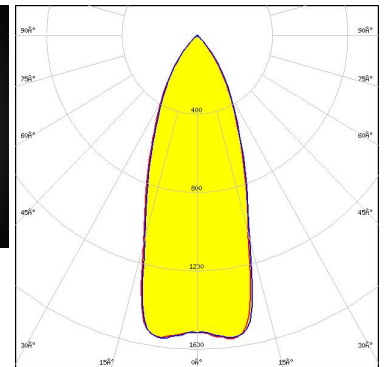
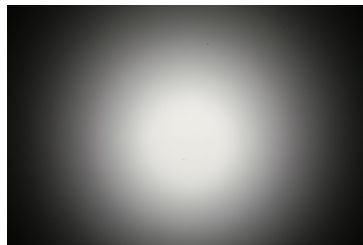

Light distribution files

OPTICAL RESULTS (MEASURED):

CITIZEN

LED CL-L340
FWHM / FWTM 17.0° / 44.0°
Efficiency 88 %
LEDs/each optic 1
Light colour/type White
Required components:
C11995_LENINA-STD-BASE-CL340

Light distribution files

CITIZEN

LED CL-L340
FWHM / FWTM 22.0° / 62.0°
Efficiency 80 %
LEDs/each optic 1
Light colour/type White
Required components:
C11995_LENINA-STD-BASE-CL340
C12606_LENINA-DL

Light distribution files

CITIZEN

LED CLL02x/CLU02x (LES10)
FWHM / FWTM 13.0° / 28.0°
Efficiency 86 %
Peak intensity 6.9 cd/lm
LEDs/each optic 1
Light colour/type White
Required components:
C13868_LENINA-STD-BASE-VERO13-18
C12606_LENINA-DL
Bender Wirth: 434 Typ L1

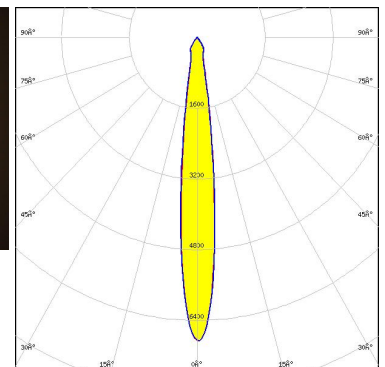
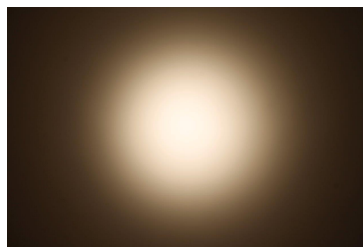

Light distribution files

OPTICAL RESULTS (MEASURED):

CITIZEN

LED CLL02x/CLU02x (LES10)
FWHM / FWTM 11.0° / 22.0°
Efficiency 91 %
Peak intensity 10.9 cd/lm
LEDs/each optic 1
Light colour/type White
Required components:
C13868_LENINA-STD-BASE-VERO13-18
Bender Wirth: 434 Typ L1

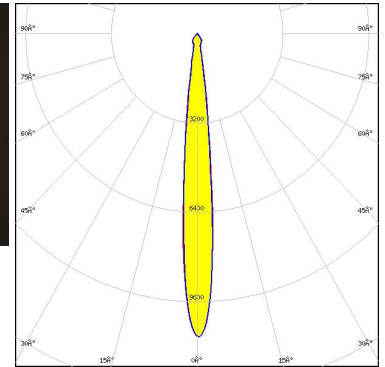

Light distribution files

CITIZEN

LED CLL03x/CLU03x
FWHM / FWTM 15.0° / 33.0°
Efficiency 91 %
Peak intensity 6.1 cd/lm
LEDs/each optic 1
Light colour/type White
Required components:
C12691_LENINA-STD-BASE-CLL030

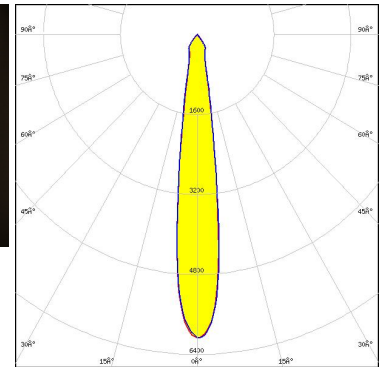

Light distribution files

CITIZEN

LED CLL03x/CLU03x
FWHM / FWTM 17.0° / 34.0°
Efficiency 91 %
Peak intensity 5.5 cd/lm
LEDs/each optic 1
Light colour/type White
Required components:
C13868_LENINA-STD-BASE-VERO13-18
Bender Wirth: 433 Typ L1

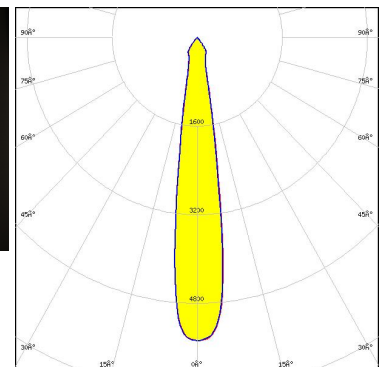

Light distribution files

OPTICAL RESULTS (MEASURED):

CITIZEN

LED CLL03x/CLU03x
 FWHM / FWTM 16.0° / 36.0°
 Efficiency 93 %
 Peak intensity 5.4 cd/lm
 LEDs/each optic 1
 Light colour/type White
 Required components:
 C12691_LENINA-STD-BASE-CLL030

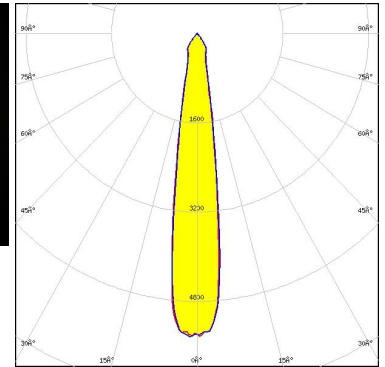

Light distribution files

CITIZEN

LED CLL03x/CLU03x
 FWHM / FWTM 17.0° / 41.0°
 Efficiency 87 %
 Peak intensity 4.5 cd/lm
 LEDs/each optic 1
 Light colour/type White
 Required components:
 C13868_LENINA-STD-BASE-VERO13-18
 C12606_LENINA-DL
 Bender Wirth: 433 Typ L1

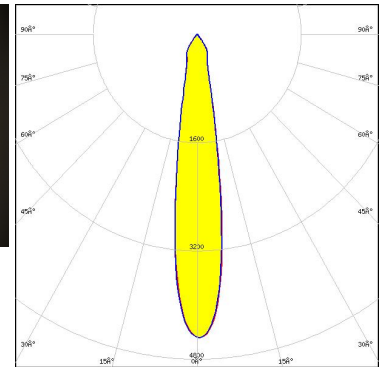

Light distribution files

CITIZEN

LED CLL03x/CLU03x
 FWHM / FWTM 17.0° / 43.0°
 Efficiency 87 %
 Peak intensity 4.5 cd/lm
 LEDs/each optic 1
 Light colour/type White
 Required components:
 C12691_LENINA-STD-BASE-CLL030
 C12606_LENINA-DL

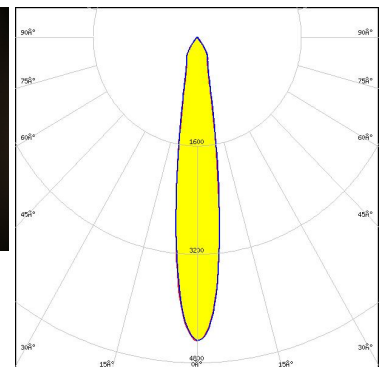
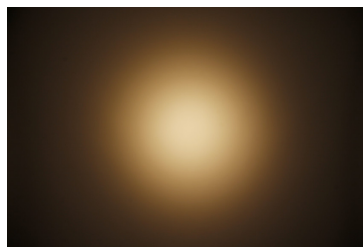

Light distribution files

OPTICAL RESULTS (MEASURED):

CITIZEN

LED CLL04x/CLU04x
 FWHM / FWTM 26.0° / 68.0°
 Efficiency 86 %
 Peak intensity 2.6 cd/lm
 LEDs/each optic 1
 Light colour/type White
 Required components:
 C12692_LENINA-STD-BASE-CLL040

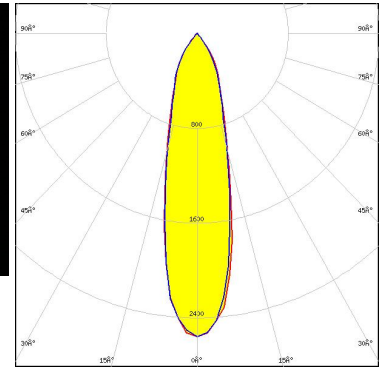

Light distribution files

CITIZEN

LED CLL04x/CLU04x
 FWHM / FWTM 24.0° / 67.0°
 Efficiency 83 %
 Peak intensity 2.5 cd/lm
 LEDs/each optic 1
 Light colour/type White
 Required components:
 A.A.G. STUCCHI: 8102-G2 + S-8000-12

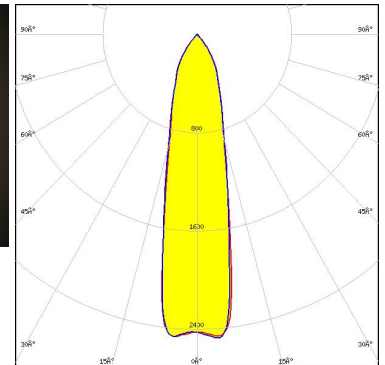
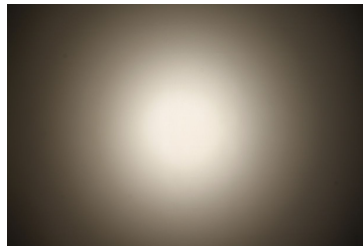

Light distribution files

CITIZEN

LED CLL04x/CLU04x
 FWHM / FWTM 27.0° / 69.0°
 Efficiency 86 %
 Peak intensity 2.2 cd/lm
 LEDs/each optic 1
 Light colour/type White
 Required components:
 C13867_LENINA-STD-BASE-VERO29
 C12606_LENINA-DL
 Bender Wirth: 431 Typ L3

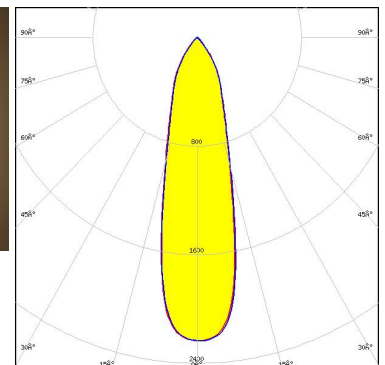
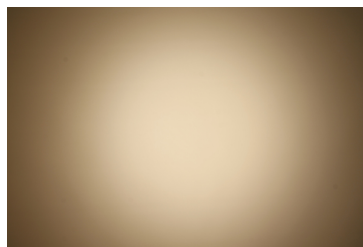

Light distribution files

OPTICAL RESULTS (MEASURED):

CITIZEN

LED CLL04x/CLU04x
FWHM / FWTM 26.0° / 68.0°
Efficiency 79 %
Peak intensity 2.2 cd/lm
LEDs/each optic 1
Light colour/type White
Required components:
C12606_LENINA-DL
A.A.G. STUCCHI: 8102-G2 + S-8000-12

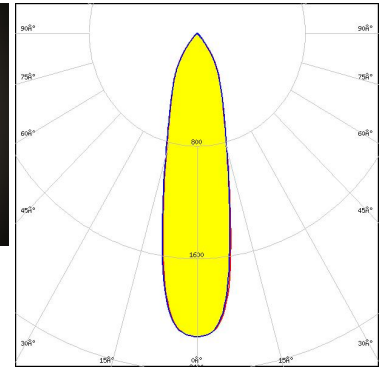
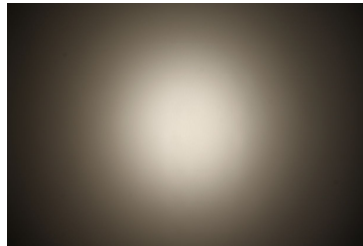

Light distribution files

CITIZEN

LED CLL04x/CLU04x
FWHM / FWTM 23.0° / 66.0°
Efficiency 90 %
Peak intensity 2.7 cd/lm
LEDs/each optic 1
Light colour/type White
Required components:
IDEAL: 50-2204CT + 50-2100LN

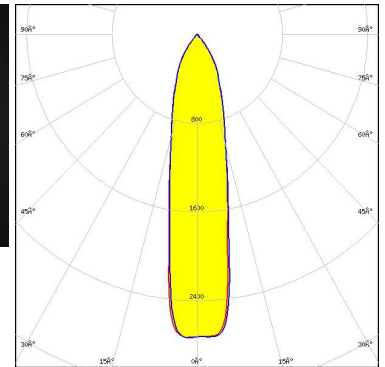
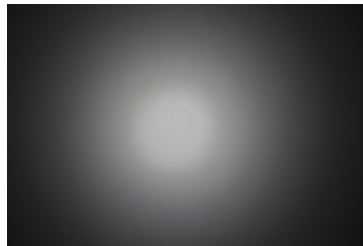

Light distribution files

CITIZEN

LED CLL04x/CLU04x
FWHM / FWTM 25.0° / 67.0°
Efficiency 87 %
Peak intensity 2.4 cd/lm
LEDs/each optic 1
Light colour/type White
Required components:
C12606_LENINA-DL
IDEAL: 50-2204CT + 50-2100LN

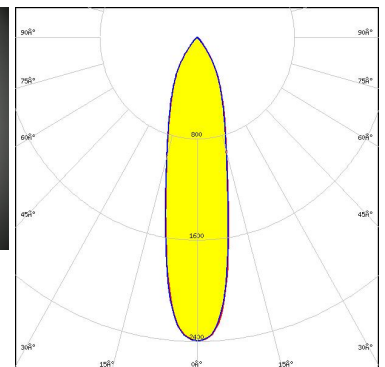
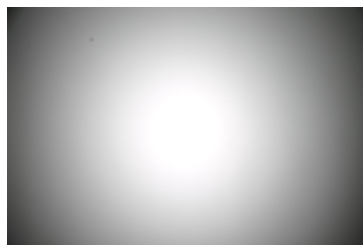

Light distribution files

OPTICAL RESULTS (MEASURED):

CITIZEN

LED CLL04x/CLU04x
 FWHM / FWTM 30.0° / 70.0°
 Efficiency 78 %
 Peak intensity 1.9 cd/lm
 LEDs/each optic 1
 Light colour/type White
 Required components:
 C12692_LENINA-STD-BASE-CLL040
 C12606_LENINA-DL

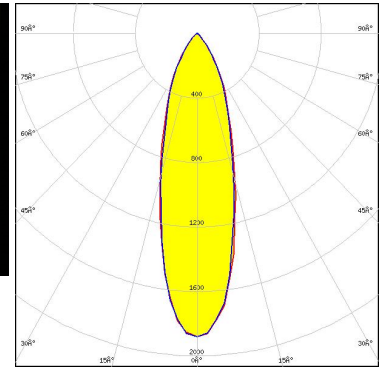

Light distribution files

CITIZEN

LED CLL04x/CLU04x
 FWHM / FWTM 26.0° / 68.0°
 Efficiency 91 %
 Peak intensity 2.6 cd/lm
 LEDs/each optic 1
 Light colour/type White
 Required components:
 C13867_LENINA-STD-BASE-VERO29
 Bender Wirth: 431 Typ L3

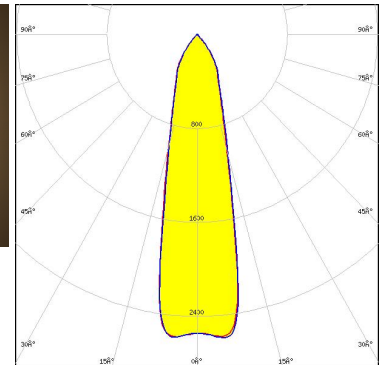
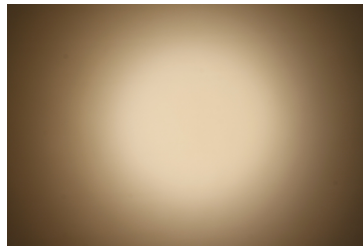

Light distribution files

CITIZEN

LED CLU700/701/702/703
 FWHM / FWTM 8.0° / 17.0°
 Efficiency 91 %
 Peak intensity 17.8 cd/lm
 LEDs/each optic 1
 Light colour/type White
 Required components:
 C13868_LENINA-STD-BASE-VERO13-18
 Bender Wirth: 434 Typ L1

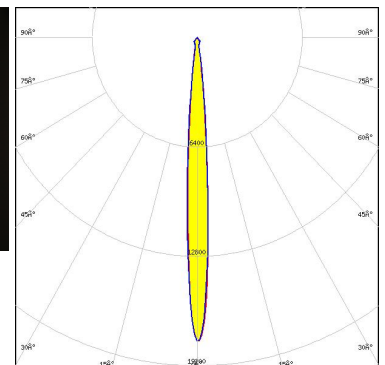

Light distribution files

OPTICAL RESULTS (MEASURED):

CITIZEN

LED CLU700/701/702/703
 FWHM / FWTM 11.0° / 23.0°
 Efficiency 86 %
 Peak intensity 9.1 cd/lm
 LEDs/each optic 1
 Light colour/type White
 Required components:
 C13868_LENINA-STD-BASE-VERO13-18
 C12606_LENINA-DL
 Bender Wirth: 434 Typ L1

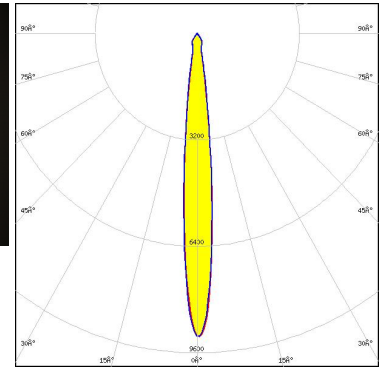

Light distribution files

CITIZEN

LED CLU710/711
 FWHM / FWTM 12.0° / 26.0°
 Efficiency 89 %
 Peak intensity 7.4 cd/lm
 LEDs/each optic 1
 Light colour/type White
 Required components:
 C12691_LENINA-STD-BASE-CLL030
 C12606_LENINA-DL

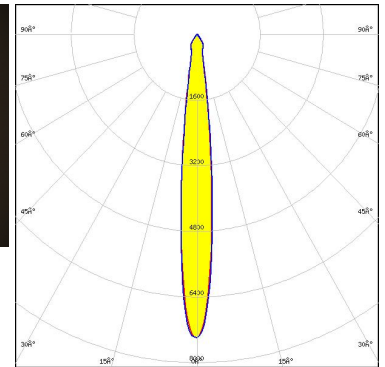

Light distribution files

CITIZEN

LED CLU710/711
 FWHM / FWTM 10.0° / 20.0°
 Efficiency 94 %
 Peak intensity 12.3 cd/lm
 LEDs/each optic 1
 Light colour/type White
 Required components:
 C12691_LENINA-STD-BASE-CLL030

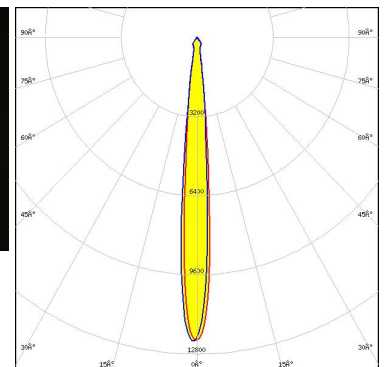

Light distribution files

OPTICAL RESULTS (MEASURED):

CITIZEN

LED CLU720/721/723
 FWHM / FWTM 13.0° / 30.0°
 Efficiency 84 %
 Peak intensity 5.8 cd/lm
 LEDs/each optic 1
 Light colour/type White
 Required components:
 C12691_LENINA-STD-BASE-CLL030
 C12606_LENINA-DL

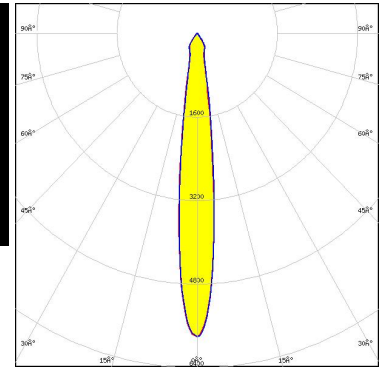
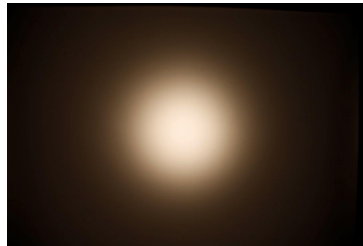

Light distribution files

CITIZEN

LED CLU720/721/723
 FWHM / FWTM 12.0° / 24.0°
 Efficiency 89 %
 Peak intensity 8.2 cd/lm
 LEDs/each optic 1
 Light colour/type White
 Required components:
 C12691_LENINA-STD-BASE-CLL030

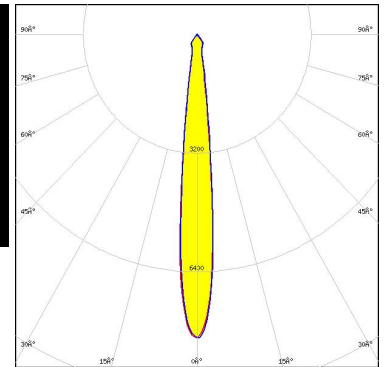
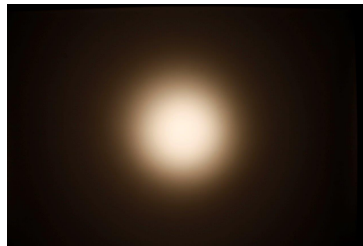

Light distribution files

CITIZEN

LED CLU730/731/733
 FWHM / FWTM 14.0° / 30.0°
 Efficiency 94 %
 Peak intensity 6.5 cd/lm
 LEDs/each optic 1
 Light colour/type White
 Required components:
 C12692_LENINA-STD-BASE-CLL040

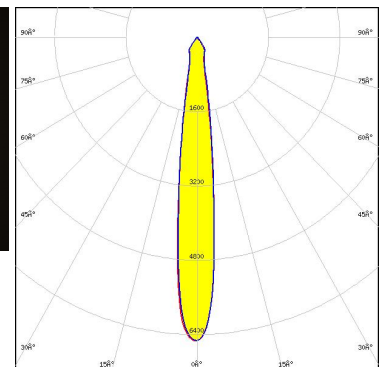

Light distribution files

OPTICAL RESULTS (MEASURED):

CITIZEN

LED CLU730/731/733
 FWHM / FWTM 15.0° / 39.0°
 Efficiency 85 %
 Peak intensity 4.6 cd/lm
 LEDs/each optic 1
 Light colour/type White
 Required components:
 C12692_LENINA-STD-BASE-CLL040
 C12606_LENINA-DL

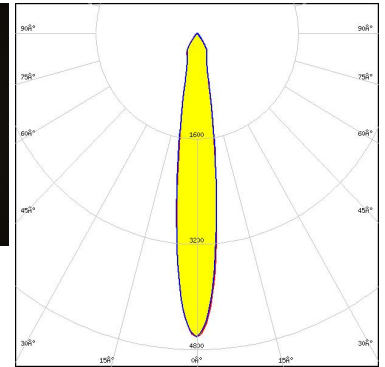
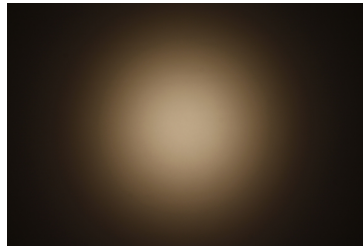

Light distribution files



LED CMA1840
 FWHM / FWTM 25.0° / 70.0°
 Efficiency 92 %
 Peak intensity 2.7 cd/lm
 LEDs/each optic 1
 Light colour/type White
 Required components:
 C14146_LENINA-STD-BASE-CXA18

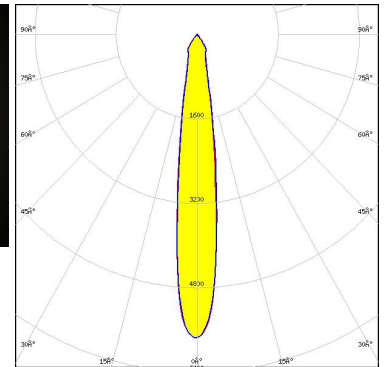
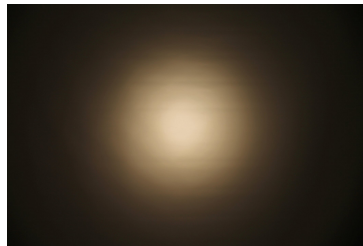

Light distribution files



LED CMA1840
 FWHM / FWTM 15.0° / 37.0°
 Efficiency 92 %
 Peak intensity 5.7 cd/lm
 LEDs/each optic 1
 Light colour/type White
 Required components:
 C14146_LENINA-STD-BASE-CXA18

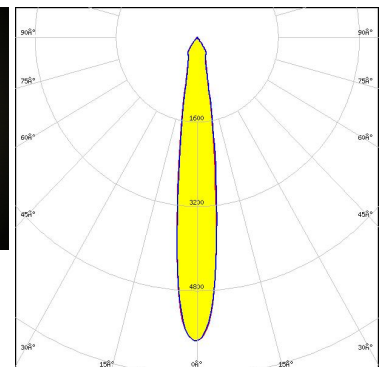
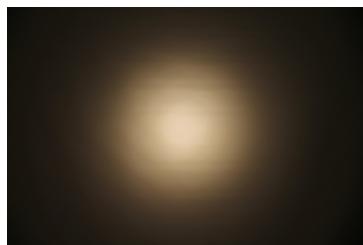

Light distribution files

OPTICAL RESULTS (MEASURED):



LED CMA2550
FWHM / FWTM 21.0° / 63.0°
Efficiency 92 %
Peak intensity 3.4 cd/lm
LEDs/each optic 1
Light colour/type White
Required components:
 C13324_LENINA-STD-BASE-CXA25

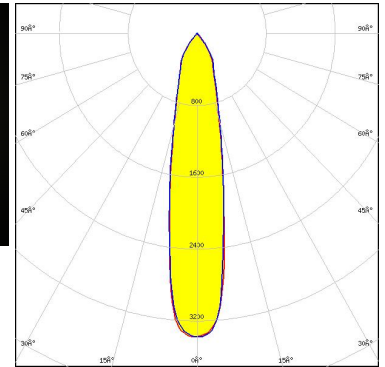
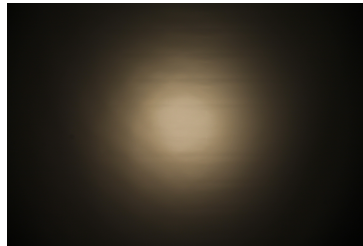

Light distribution files



LED CMT14xx
FWHM / FWTM 11.0° / 24.0°
Efficiency 92 %
Peak intensity 9.7 cd/lm
LEDs/each optic 1
Light colour/type White
Required components:
 C13868_LENINA-STD-BASE-VERO13-18
 Bender Wirth: 434 Typ L1

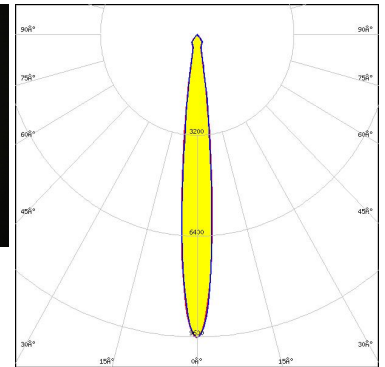
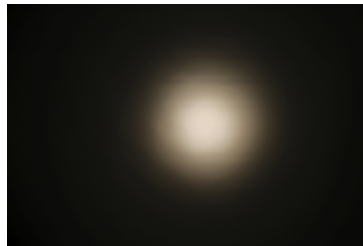

Light distribution files



LED CMT19xx
FWHM / FWTM 17.0° / 37.0°
Efficiency 92 %
Peak intensity 5.3 cd/lm
LEDs/each optic 1
Light colour/type White
Required components:
 C13868_LENINA-STD-BASE-VERO13-18
 Bender Wirth: 477 Typ L1

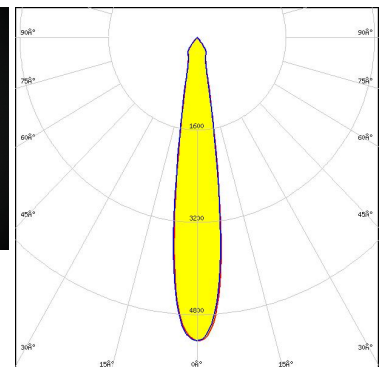
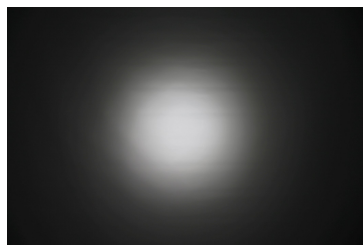

Light distribution files

OPTICAL RESULTS (MEASURED):



LED CMT19xx
FWHM / FWTM 16.0° / 37.0°
Efficiency 92 %
Peak intensity 5.3 cd/lm
LEDs/each optic 1
Light colour/type White
Required components:
 C12691_LENINA-STD-BASE-CLL030

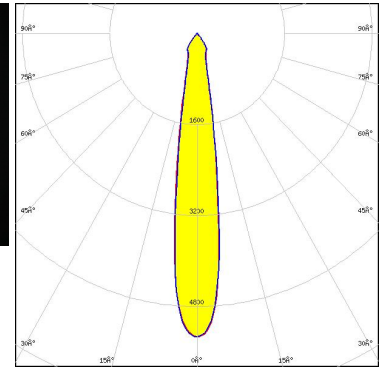
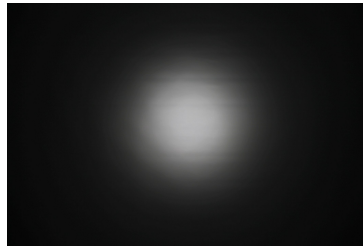

Light distribution files



LED CMT28xx
FWHM / FWTM 26.0° / 68.0°
Efficiency 92 %
Peak intensity 2.6 cd/lm
LEDs/each optic 1
Light colour/type White
Required components:
 C13867_LENINA-STD-BASE-VERO29
 Bender Wirth: 471 Typ L3

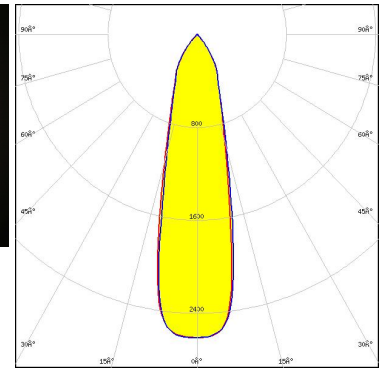

Light distribution files



LED CMT28xx
FWHM / FWTM 26.0° / 68.0°
Efficiency 92 %
Peak intensity 2.6 cd/lm
LEDs/each optic 1
Light colour/type White
Required components:
 C12692_LENINA-STD-BASE-CLL040

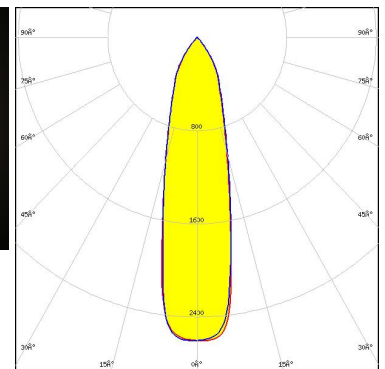
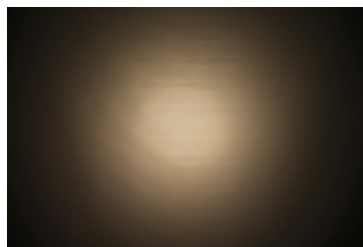

Light distribution files

OPTICAL RESULTS (MEASURED):



LED CXA/B 15xx
FWHM / FWTM 12.0° / 26.0°
Efficiency 86 %
Peak intensity 7.6 cd/lm
LEDs/each optic 1
Light colour/type White

Required components:

C13186_LENINA-STD-BASE-CXA15
C12606_LENINA-DL

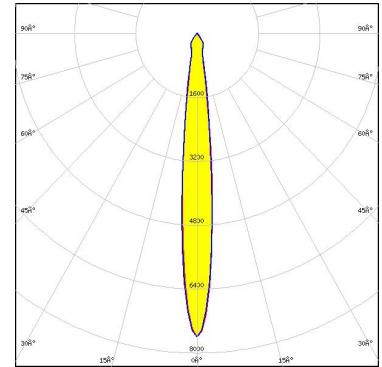

Light distribution files



LED CXA/B 15xx
FWHM / FWTM 13.0° / 27.0°
Efficiency 87 %
Peak intensity 7.2 cd/lm
LEDs/each optic 1
Light colour/type White

Required components:

C13868_LENINA-STD-BASE-VERO13-18
C12606_LENINA-DL
Bender Wirth: 441 Typ L1

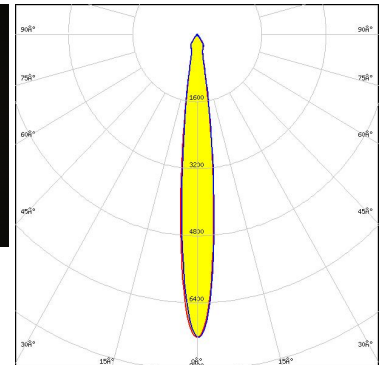
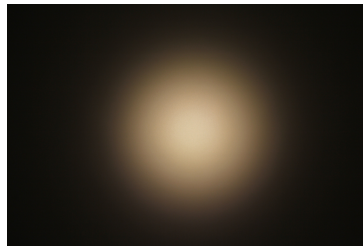

Light distribution files



LED CXA/B 15xx
FWHM / FWTM 10.0° / 20.0°
Efficiency 91 %
Peak intensity 12.1 cd/lm
LEDs/each optic 1
Light colour/type White

Required components:

C13186_LENINA-STD-BASE-CXA15

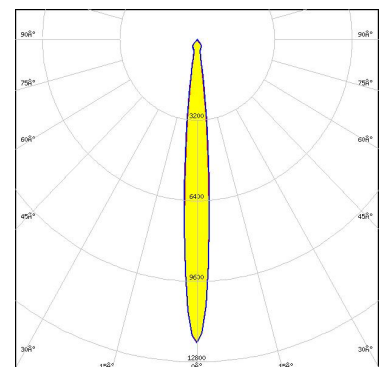

Light distribution files

OPTICAL RESULTS (MEASURED):



LED CXA/B 15xx
 FWHM / FWTM 10.0° / 21.0°
 Efficiency 91 %
 Peak intensity 11.9 cd/lm
 LEDs/each optic 1
 Light colour/type White

Required components:

C13868_LENINA-STD-BASE-VERO13-18
 Bender Wirth: 441 Typ L1

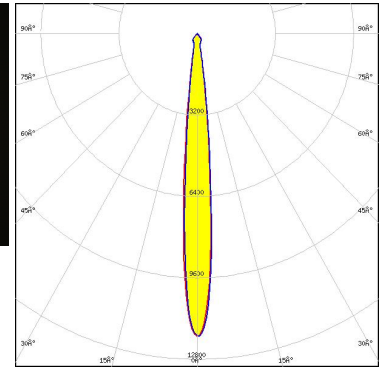

Light distribution files



LED CXA/B 1816 & CXA/B 1820 & CXA 1850
 FWHM / FWTM 15.0° / 32.0°
 Efficiency 88 %
 Peak intensity 5.9 cd/lm
 LEDs/each optic 1
 Light colour/type White

Required components:

C13868_LENINA-STD-BASE-VERO13-18
 C12606_LENINA-DL
 Bender Wirth: 437 Typ L1

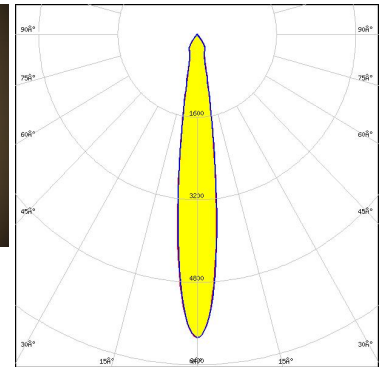

Light distribution files



LED CXA/B 1816 & CXA/B 1820 & CXA 1850
 FWHM / FWTM 12.0° / 28.0°
 Efficiency 92 %
 Peak intensity 9.6 cd/lm
 LEDs/each optic 1
 Light colour/type White

Required components:

C14146_LENINA-STD-BASE-CXA18



OPTICAL RESULTS (MEASURED):



LED CXA/B 1816 & CXA/B 1820 & CXA 1850
 FWHM / FWTM 13.0° / 26.0°
 Efficiency 92 %
 Peak intensity 8 cd/lm
 LEDs/each optic 1
 Light colour/type White
 Required components:
 C13868_LENINA-STD-BASE-VERO13-18
 Bender Wirth: 437 Typ L1

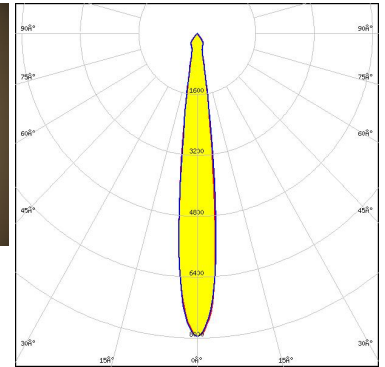

Light distribution files



LED CXA/B 1830
 FWHM / FWTM 18.0° / 41.0°
 Efficiency 88 %
 Peak intensity 4.5 cd/lm
 LEDs/each optic 1
 Light colour/type White
 Required components:
 C13868_LENINA-STD-BASE-VERO13-18
 C12606_LENINA-DL
 Bender Wirth: 437 Typ L1

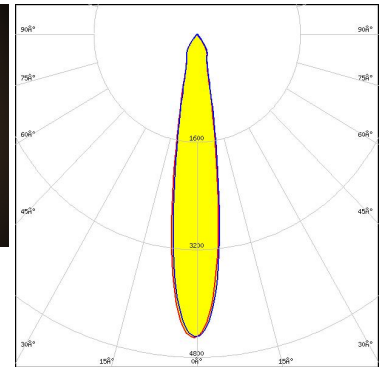

Light distribution files



LED CXA/B 1830
 FWHM / FWTM 16.0° / 33.0°
 Efficiency 93 %
 Peak intensity 5.8 cd/lm
 LEDs/each optic 1
 Light colour/type White
 Required components:
 C13868_LENINA-STD-BASE-VERO13-18
 Bender Wirth: 437 Typ L1

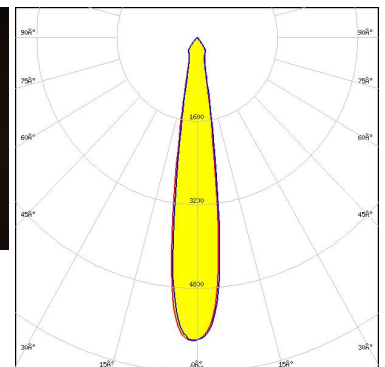

Light distribution files

OPTICAL RESULTS (MEASURED):



LED CXA/B 25xx
 FWHM / FWTM 23.0° / 65.0°
 Efficiency 78 %
 Peak intensity 2.7 cd/m
 LEDs/each optic 1
 Light colour/type White

Required components:

C13324_LENINA-STD-BASE-CXA25
 C12606_LENINA-DL

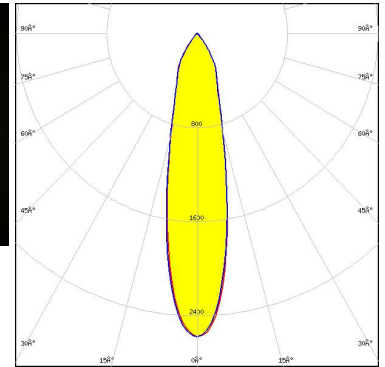
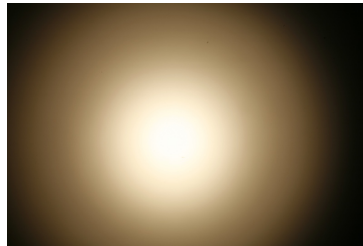

Light distribution files



LED CXA/B 25xx
 FWHM / FWTM 22.0° / 63.0°
 Efficiency 86 %
 Peak intensity 3.2 cd/m
 LEDs/each optic 1
 Light colour/type White

Required components:

C13324_LENINA-STD-BASE-CXA25

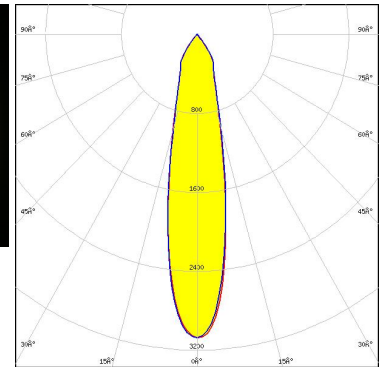
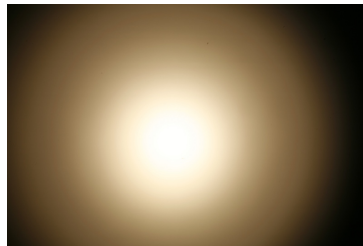

Light distribution files



LED CXA2011
 FWHM / FWTM 20.0° / 60.0°
 Efficiency 80 %
 Peak intensity 3.5 cd/m
 LEDs/each optic 1
 Light colour/type White

Required components:

C12105_LENINA-STD-BASE-CXA20
 C12606_LENINA-DL

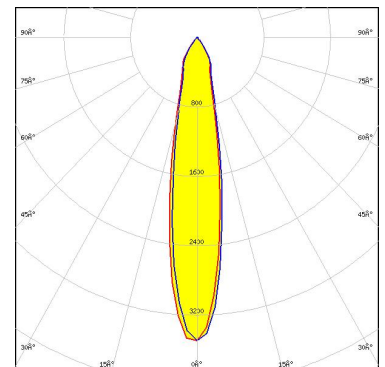

Light distribution files

OPTICAL RESULTS (MEASURED):



LED CXA2011
FWHM / FWTM 16.0° / 38.0°
Efficiency 88 %
Peak intensity 4.4 cd/lm
LEDs/each optic 1
Light colour/type White
Required components:
C12105_LENINA-STD-BASE-CXA20

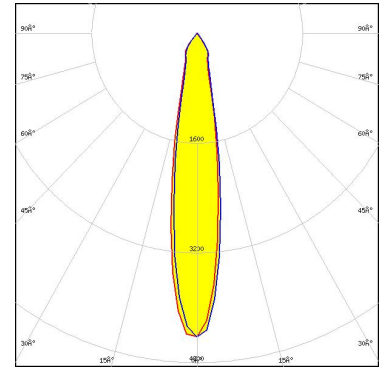

Light distribution files



LED CHI3030 19W
FWHM / FWTM 25.0° / 68.0°
Efficiency 91 %
Peak intensity 2.6 cd/lm
LEDs/each optic 1
Light colour/type White
Required components:
C13867_LENINA-STD-BASE-VERO29
C12606_LENINA-DL
Bender Wirth: 468 Typ L3

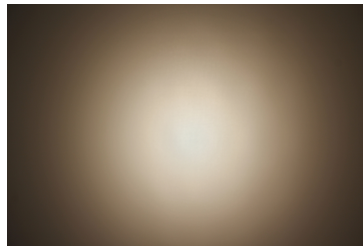

Light distribution files



LED CHI3030 29W
FWHM / FWTM 33.0° / 76.0°
Efficiency 87 %
Peak intensity 1.7 cd/lm
LEDs/each optic 1
Light colour/type White
Required components:
C13867_LENINA-STD-BASE-VERO29
C12606_LENINA-DL
Bender Wirth: 468 Typ L3

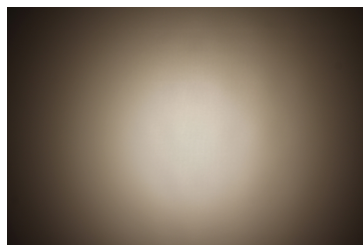

Light distribution files

OPTICAL RESULTS (MEASURED):



LED LUXEON CoB 1202/1203
 FWHM / FWTM 13.0° / 27.0°
 Efficiency 88 %
 Peak intensity 7.5 cd/lm
 LEDs/each optic 1
 Light colour/type White
 Required components:
 C13868_LENINA-STD-BASE-VERO13-18
 C12606_LENINA-DL
 Bender Wirth: 438 Typ L1

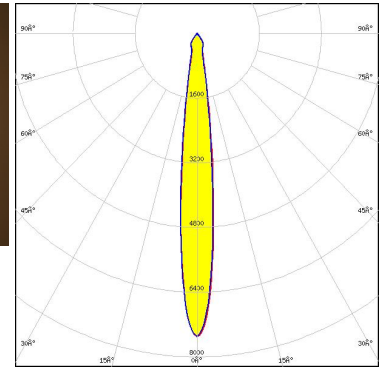

Light distribution files



LED LUXEON CoB 1202/1203
 FWHM / FWTM 11.0° / 21.0°
 Efficiency 92 %
 Peak intensity 11.5 cd/lm
 LEDs/each optic 1
 Light colour/type White
 Required components:
 C13868_LENINA-STD-BASE-VERO13-18
 Bender Wirth: 438 Typ L1

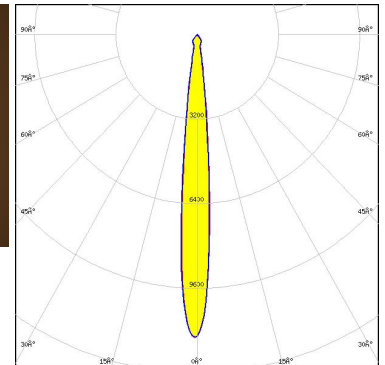

Light distribution files



LED LUXEON CoB 1204/1205
 FWHM / FWTM 19.0° / 53.0°
 Efficiency 84 %
 Peak intensity 3.6 cd/lm
 LEDs/each optic 1
 Light colour/type White
 Required components:
 C12292_LENINA-STD-BASE-MEZ
 C12606_LENINA-DL

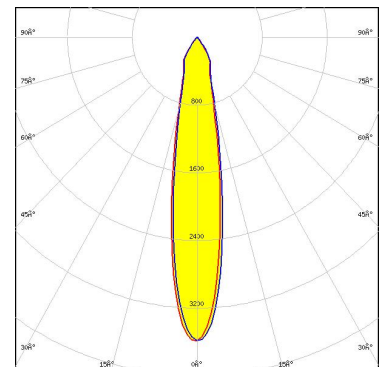

Light distribution files

OPTICAL RESULTS (MEASURED):



LED LUXEON CoB 1204/1205
FWHM / FWTM 18.0° / 42.0°
Efficiency 88 %
Peak intensity 4.5 cd/lm
LEDs/each optic 1
Light colour/type White
Required components:
C12292_LENINA-STD-BASE-MEZ

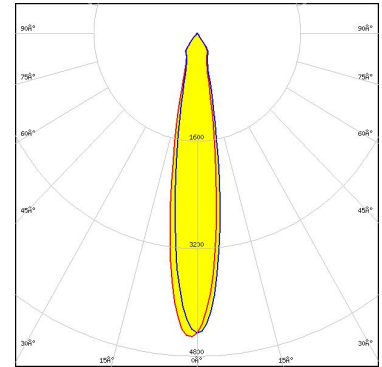

Light distribution files



LED LUXEON CoB 1204HD
FWHM / FWTM 10.0° / 22.0°
Efficiency 92 %
Peak intensity 10.9 cd/lm
LEDs/each optic 1
Light colour/type White
Required components:
C11981_LENINA-STD-BASE-COB-L110

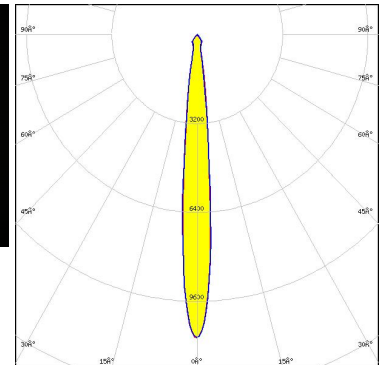

Light distribution files



LED LUXEON CoB 1205HD
FWHM / FWTM 12.0° / 27.0°
Efficiency 92 %
Peak intensity 8.2 cd/lm
LEDs/each optic 1
Light colour/type White
Required components:
C11981_LENINA-STD-BASE-COB-L110

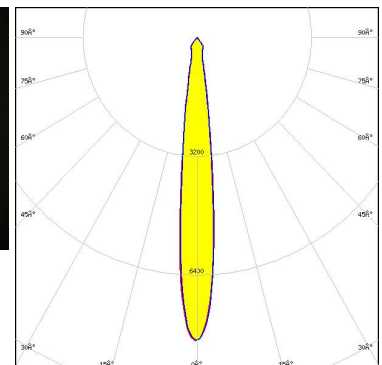
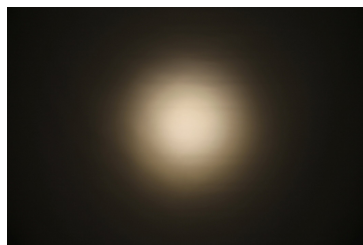

Light distribution files

OPTICAL RESULTS (MEASURED):



LED LUXEON CoB 1208
FWHM / FWTM 21.0° / 61.0°
Efficiency 85 %
Peak intensity 3.2 cd/lm
LEDs/each optic 1
Light colour/type White
Required components:
 C12292_LENINA-STD-BASE-MEZ
 C12606_LENINA-DL

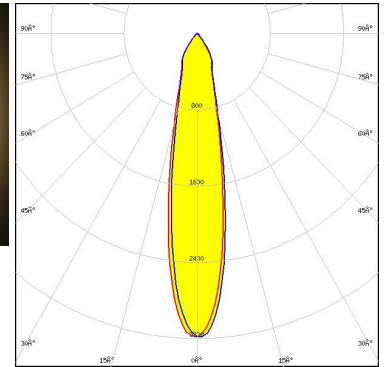

Light distribution files



LED LUXEON CoB 1208
FWHM / FWTM 20.0° / 50.0°
Efficiency 89 %
Peak intensity 3.9 cd/lm
LEDs/each optic 1
Light colour/type White
Required components:
 C12292_LENINA-STD-BASE-MEZ

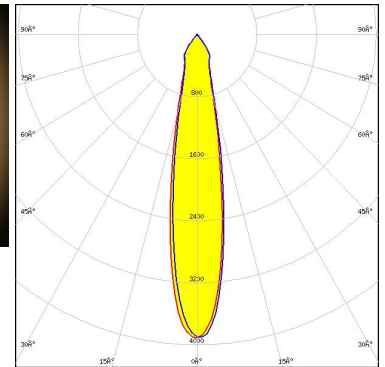

Light distribution files



LED LUXEON CoB 1211
FWHM / FWTM 22.0° / 61.0°
Efficiency 92 %
Peak intensity 3.4 cd/lm
LEDs/each optic 1
Light colour/type White
Required components:
 C13867_LENINA-STD-BASE-VERO29
 Bender Wirth: 431 Typ L3

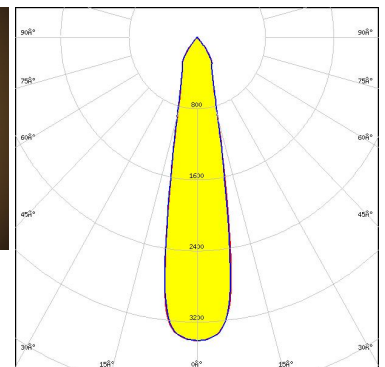
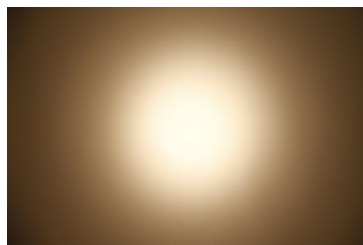

Light distribution files

OPTICAL RESULTS (MEASURED):



LED LUXEON CoB 1211
FWHM / FWTM 23.0° / 64.0°
Efficiency 86 %
Peak intensity 2.8 cd/m
LEDs/each optic 1
Light colour/type White
Required components:
 C13867_LENINA-STD-BASE-VERO29
 C12606_LENINA-DL
 Bender Wirth: 431 Typ L3

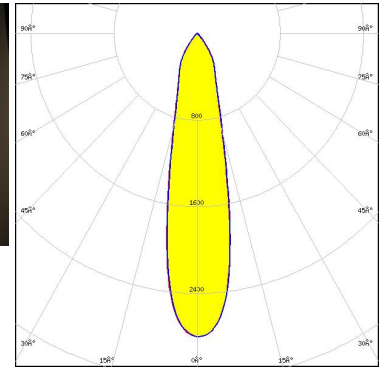
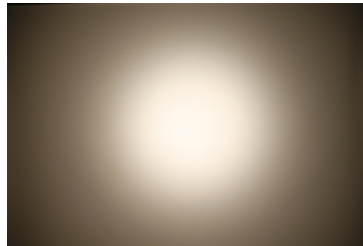

Light distribution files



LED LUXEON CoB 1213/1216/1812
FWHM / FWTM 28.0° / 69.0°
Efficiency 87 %
Peak intensity 2.2 cd/m
LEDs/each optic 1
Light colour/type White
Required components:
 C12692_LENINA-STD-BASE-CLL040
 C12606_LENINA-DL

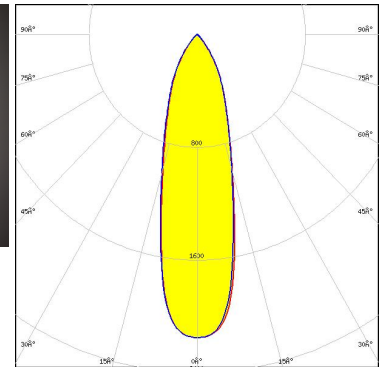
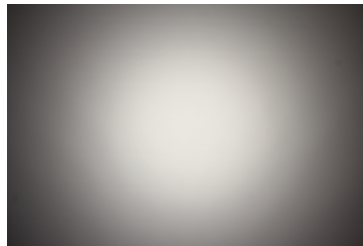

Light distribution files



LED LUXEON CoB 1213/1216/1812
FWHM / FWTM 27.0° / 68.0°
Efficiency 91 %
Peak intensity 2.5 cd/m
LEDs/each optic 1
Light colour/type White
Required components:
 C12692_LENINA-STD-BASE-CLL040

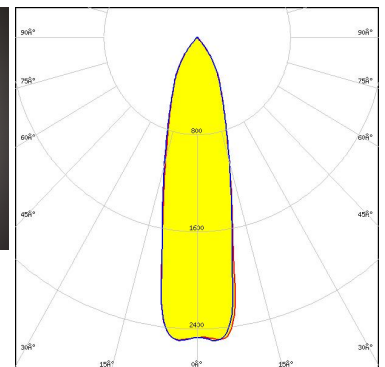
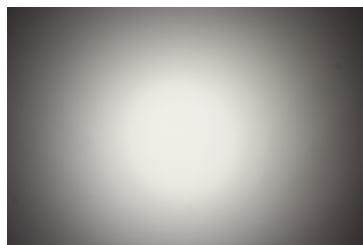

Light distribution files

OPTICAL RESULTS (MEASURED):



LED LUXEON CoB 1213/1216/1812
 FWHM / FWTM 25.0° / 68.0°
 Efficiency 85 %
 Peak intensity 2.4 cd/lm
 LEDs/each optic 1
 Light colour/type White
 Required components:
 A.A.G. STUCCHI: 8102-G2 + S-8000-12

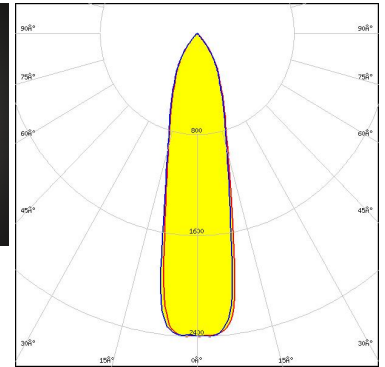
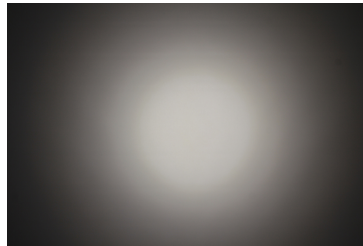

Light distribution files



LED LUXEON CoB 1213/1216/1812
 FWHM / FWTM 27.0° / 69.0°
 Efficiency 81 %
 Peak intensity 2.1 cd/lm
 LEDs/each optic 1
 Light colour/type White
 Required components:
 C12606_LENINA-DL
 A.A.G. STUCCHI: 8102-G2 + S-8000-12

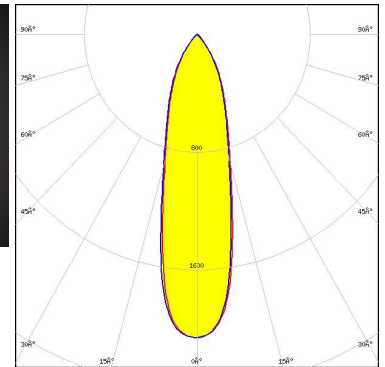
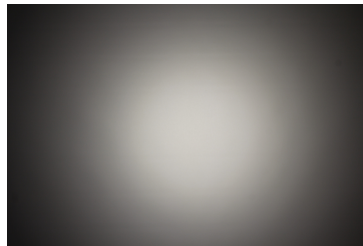

Light distribution files



LED LUXEON K12
 FWHM / FWTM 17.5° / 57.0°
 Efficiency 83 %
 Peak intensity 3.7 cd/lm
 LEDs/each optic 1
 Light colour/type White
 Required components:
 C12924_LENINA-STD-BASE-LUXEON-K
 C12606_LENINA-DL

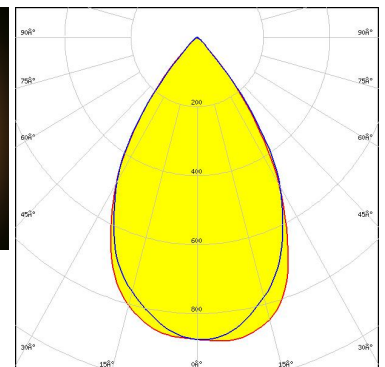

Light distribution files

OPTICAL RESULTS (MEASURED):



LED LUXEON K12
FWHM / FWTM 16.0° / 41.0°
Efficiency 89 %
Peak intensity 4.8 cd/lm
LEDs/each optic 1
Light colour/type White
Required components:
 C12924_LENINA-STD-BASE-LUXEON-K

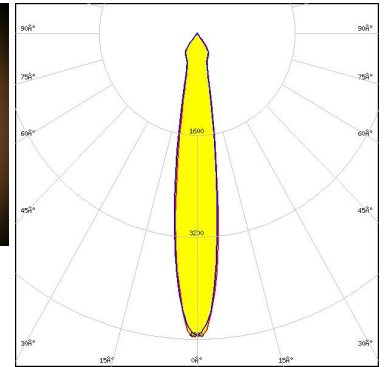
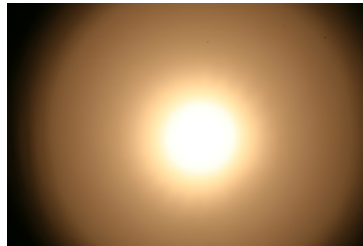

Light distribution files



LED LUXEON K16
FWHM / FWTM 18.0° / 50.0°
Efficiency 87 %
Peak intensity 4 cd/lm
LEDs/each optic 1
Light colour/type White
Required components:
 C12924_LENINA-STD-BASE-LUXEON-K

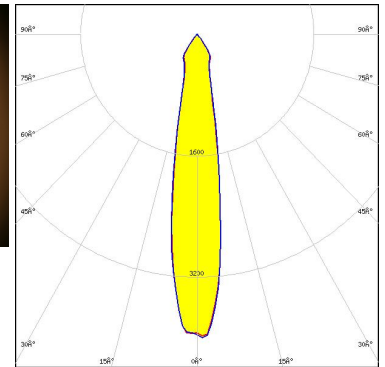
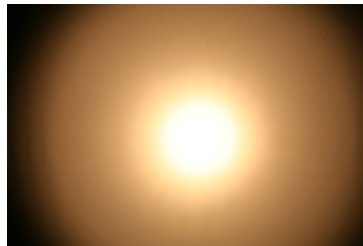

Light distribution files



LED LUXEON K16
FWHM / FWTM 22.0° / 64.0°
Efficiency 80 %
Peak intensity 2.6 cd/lm
LEDs/each optic 1
Light colour/type White
Required components:
 C12924_LENINA-STD-BASE-LUXEON-K
 C12606_LENINA-DL

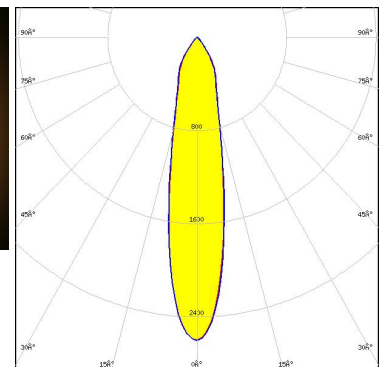

Light distribution files

OPTICAL RESULTS (MEASURED):



LED CDM-14 (Dim-To-Warm)
 FWHM / FWTM 16.0° / 38.0°
 Efficiency 88 %
 Peak intensity 4.9 cd/lm
 LEDs/each optic 1
 Light colour/type White
 Required components:
 C13868_LENINA-STD-BASE-VERO13-18
 C12606_LENINA-DL
 Bender Wirth: 491 Typ L2

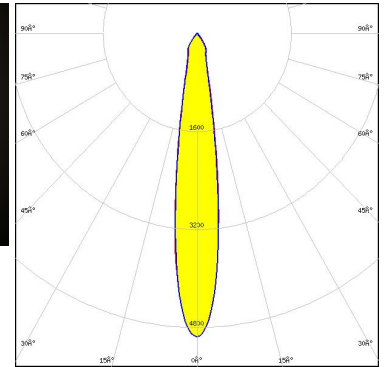

Light distribution files



LED CDM-18 (Dim-To-Warm)
 FWHM / FWTM 21.0° / 51.0°
 Efficiency 88 %
 Peak intensity 3.6 cd/lm
 LEDs/each optic 1
 Light colour/type White
 Required components:
 C13868_LENINA-STD-BASE-VERO13-18
 C12606_LENINA-DL
 Bender Wirth: 491 Typ L2

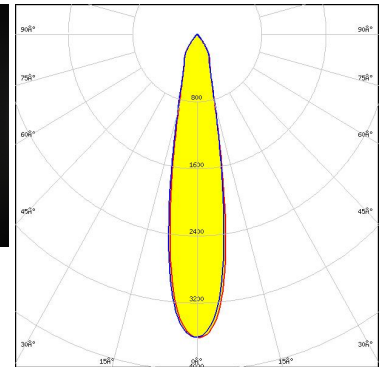
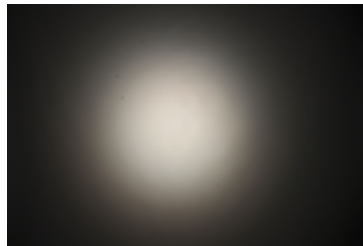

Light distribution files



LED CDM-9 (Dim-To-Warm)
 FWHM / FWTM 11.0° / 21.0°
 Efficiency 92 %
 Peak intensity 12 cd/lm
 LEDs/each optic 1
 Light colour/type White
 Required components:
 C13868_LENINA-STD-BASE-VERO13-18
 Bender Wirth: 490 Typ L1

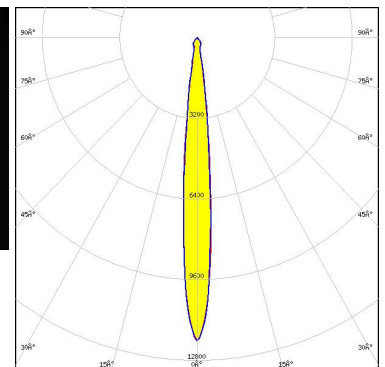

Light distribution files

OPTICAL RESULTS (MEASURED):



LED CDM-9 (Dim-To-Warm)
FWHM / FWTM 13.0° / 27.0°
Efficiency 87 %
Peak intensity 7.4 cd/lm
LEDs/each optic 1
Light colour/type White
Required components:
 C13868_LENINA-STD-BASE-VERO13-18
 C12606_LENINA-DL
 Bender Wirth: 490 Typ L1

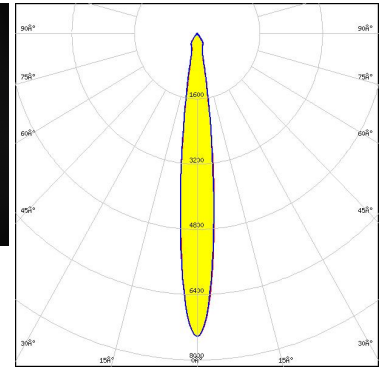
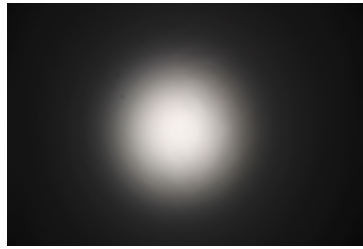

Light distribution files



LED CTM-14 (Tunable White)
FWHM / FWTM 15.0° / 29.0°
Efficiency 92 %
Peak intensity 6.8 cd/lm
LEDs/each optic 1
Light colour/type White
Required components:
 C13867_LENINA-STD-BASE-VERO29
 Bender Wirth: 442 Typ L3

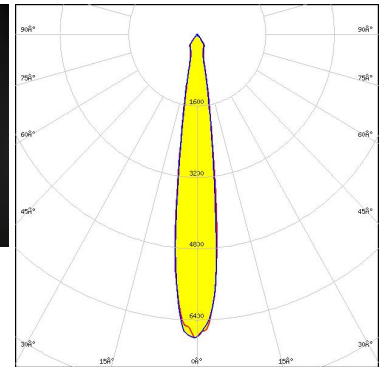

Light distribution files



LED CTM-14 (Tunable White)
FWHM / FWTM 16.0° / 37.0°
Efficiency 87 %
Peak intensity 5 cd/lm
LEDs/each optic 1
Light colour/type White
Required components:
 C13867_LENINA-STD-BASE-VERO29
 C12606_LENINA-DL
 Bender Wirth: 442 Typ L3

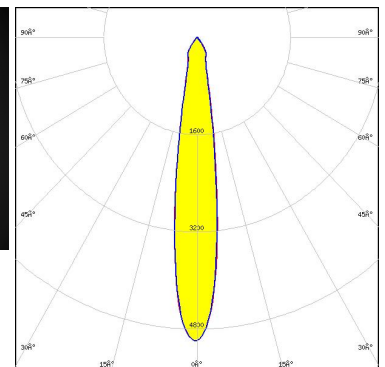

Light distribution files

OPTICAL RESULTS (MEASURED):



LED CTM-18 (Tunable White)
FWHM / FWTM 18.0° / 39.0°
Efficiency 92 %
Peak intensity 4.8 cd/lm
LEDs/each optic 1
Light colour/type White
Required components:
 C13867_LENINA-STD-BASE-VERO29
 Bender Wirth: 442 Typ L3

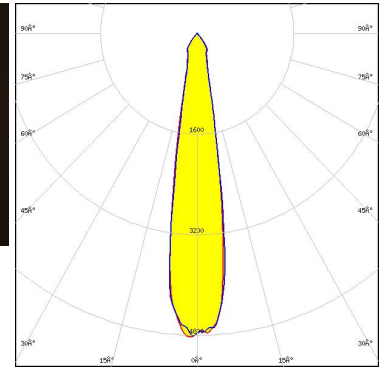

Light distribution files



LED CTM-18 (Tunable White)
FWHM / FWTM 19.0° / 48.0°
Efficiency 87 %
Peak intensity 3.8 cd/lm
LEDs/each optic 1
Light colour/type White
Required components:
 C13867_LENINA-STD-BASE-VERO29
 C12606_LENINA-DL
 Bender Wirth: 442 Typ L3

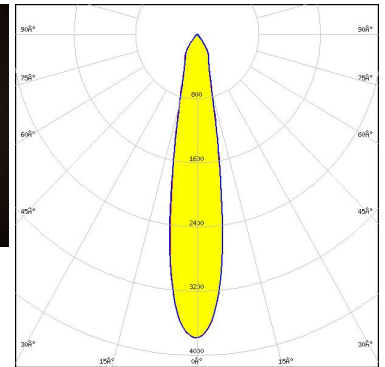

Light distribution files



LED CTM-22 (Tunable White)
FWHM / FWTM 26.0° / 67.0°
Efficiency 87 %
Peak intensity 2.4 cd/lm
LEDs/each optic 1
Light colour/type White
Required components:
 C13867_LENINA-STD-BASE-VERO29
 C12606_LENINA-DL
 Bender Wirth: 494 Typ L3

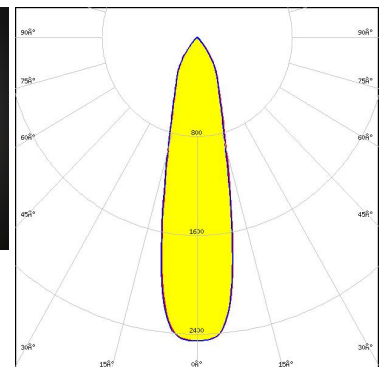
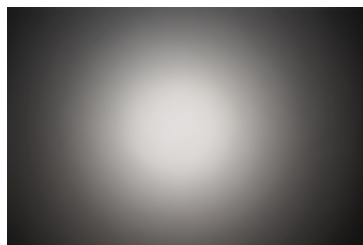

Light distribution files

OPTICAL RESULTS (MEASURED):



LED CxM-14 (19x19)
FWHM / FWTM 16.0° / 32.0°
Efficiency 93 %
Peak intensity 6.2 cd/lm
LEDs/each optic 1
Light colour/type White
Required components:
 C12691_LENINA-STD-BASE-CLL030

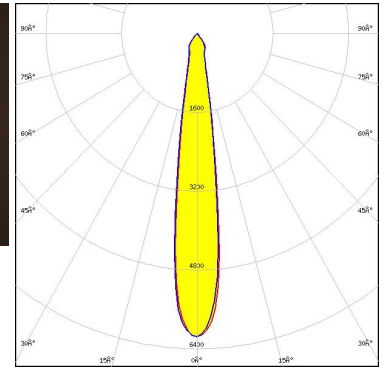

Light distribution files



LED CxM-14 (19x19)
FWHM / FWTM 17.0° / 40.0°
Efficiency 88 %
Peak intensity 4.9 cd/lm
LEDs/each optic 1
Light colour/type White
Required components:
 C12691_LENINA-STD-BASE-CLL030
 C12606_LENINA-DL

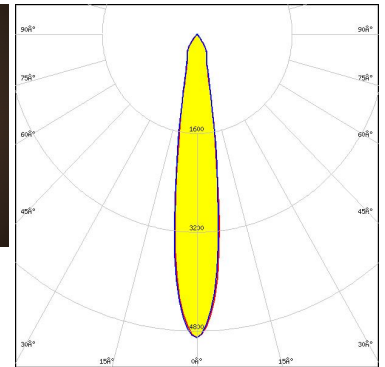
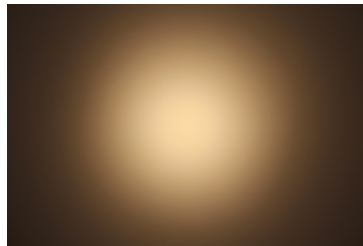

Light distribution files



LED CxM-22 (28x28)
FWHM / FWTM 28.0° / 72.0°
Efficiency 88 %
Peak intensity 2.3 cd/lm
LEDs/each optic 1
Light colour/type White
Required components:
 C12692_LENINA-STD-BASE-CLL040
 C12606_LENINA-DL

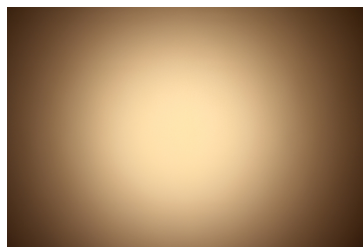

Light distribution files

OPTICAL RESULTS (MEASURED):



LED COB J-Type
FWHM / FWTM 21.0° / 61.0°
Efficiency 83 %
Peak intensity 3.1 cd/lm
LEDs/each optic 1
Light colour/type White
Required components:
C12292_LENINA-STD-BASE-MEZ
C12606_LENINA-DL

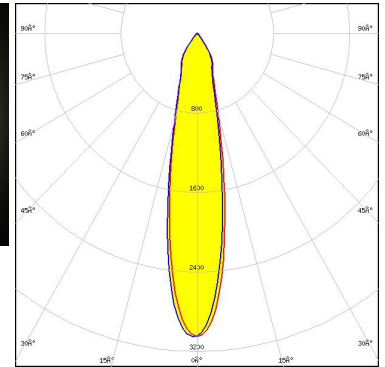

Light distribution files



LED COB J-Type
FWHM / FWTM 20.0° / 51.0°
Efficiency 88 %
Peak intensity 3.8 cd/lm
LEDs/each optic 1
Light colour/type White
Required components:
C12292_LENINA-STD-BASE-MEZ

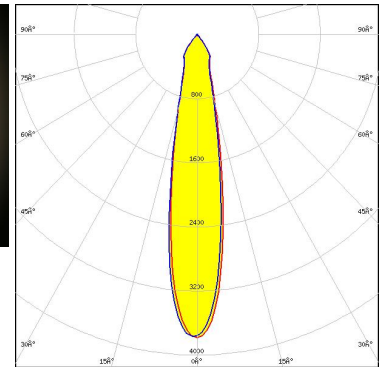

Light distribution files



LED COB J-Type
FWHM / FWTM 17.0° / 35.0°
Efficiency 92 %
Peak intensity 5.6 cd/lm
LEDs/each optic 1
Light colour/type White
Required components:
C13868_LENINA-STD-BASE-VERO13-18
Bender Wirth: 463 Typ L2

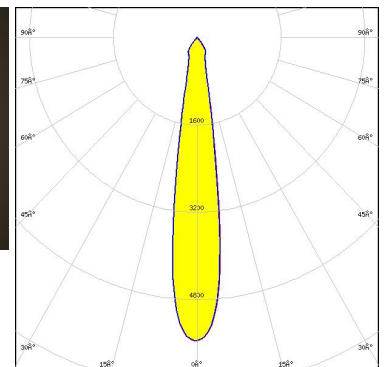
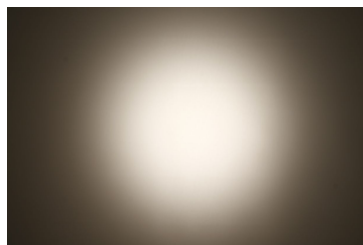

Light distribution files

OPTICAL RESULTS (MEASURED):



LED COB J-Type
FWHM / FWTM 18.0° / 44.0°
Efficiency 88 %
Peak intensity 4.2 cd/lm
LEDs/each optic 1
Light colour/type White
Required components:
 C13868_LENINA-STD-BASE-VERO13-18
 C12606_LENINA-DL
 Bender Wirth: 463 Typ L2

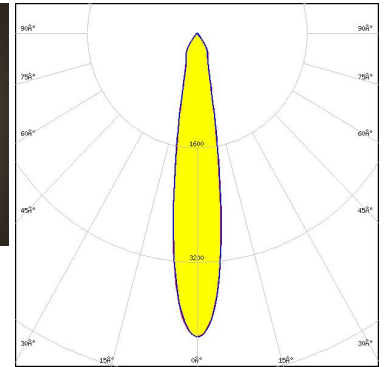
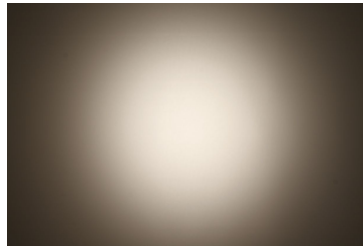

Light distribution files



LED COB L-Type (LES 11)
FWHM / FWTM 17.0° / 38.0°
Efficiency 85 %
Peak intensity 4.7 cd/lm
LEDs/each optic 1
Light colour/type White
Required components:
 C11981_LENINA-STD-BASE-COB-L110

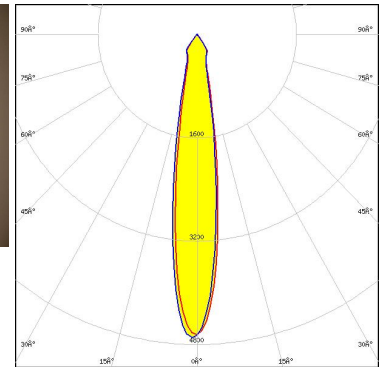
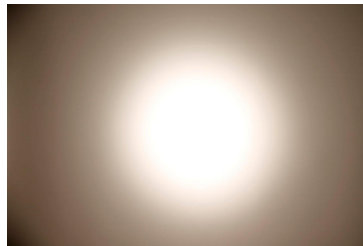

Light distribution files



LED COB L-Type (LES 11)
FWHM / FWTM 13.0° / 26.0°
Efficiency 91 %
Peak intensity 8.3 cd/lm
LEDs/each optic 1
Light colour/type White
Required components:
 C13868_LENINA-STD-BASE-VERO13-18
 Bender Wirth: 438 Typ L1

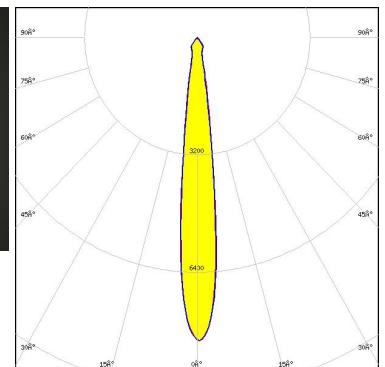

Light distribution files

OPTICAL RESULTS (MEASURED):



LED COB L-Type (LES 11)
FWHM / FWTM 15.0° / 32.0°
Efficiency 87 %
Peak intensity 5.8 cd/lm
LEDs/each optic 1
Light colour/type White
Required components:
 C13868_LENINA-STD-BASE-VERO13-18
 C12606_LENINA-DL
 Bender Wirth: 438 Typ L1

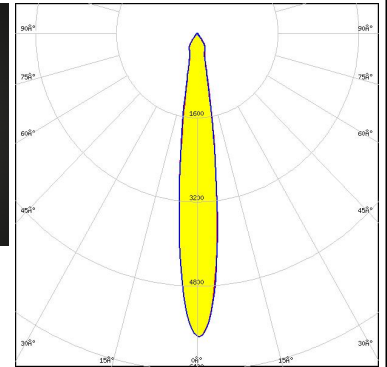

Light distribution files



LED COB L-Type (LES 11)
FWHM / FWTM 18.0° / 49.0°
Efficiency 81 %
Peak intensity 3.7 cd/lm
LEDs/each optic 1
Light colour/type White
Required components:
 C11981_LENINA-STD-BASE-COB-L110
 C12606_LENINA-DL

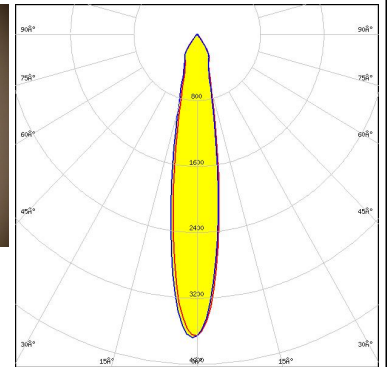
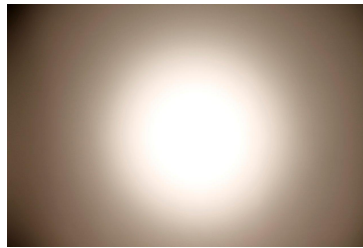

Light distribution files



LED COB L-Type (LES 9)
FWHM / FWTM 10.0° / 21.0°
Efficiency 94 %
Peak intensity 12.1 cd/lm
LEDs/each optic 1
Light colour/type White
Required components:
 C13868_LENINA-STD-BASE-VERO13-18
 Bender Wirth: 438 Typ L1

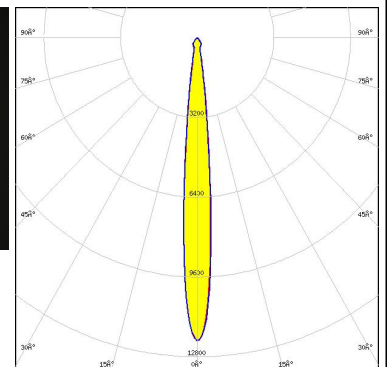
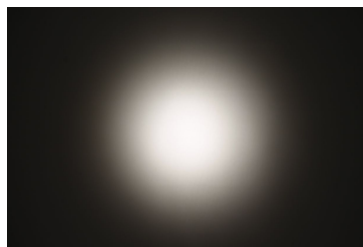

Light distribution files

OPTICAL RESULTS (MEASURED):



LED COB L-Type (LES 9)
 FWHM / FWTM 12.0° / 26.0°
 Efficiency 90 %
 Peak intensity 7.8 cd/lm
 LEDs/each optic 1
 Light colour/type White
 Required components:
 C13868_LENINA-STD-BASE-VERO13-18
 C12606_LENINA-DL
 Bender Wirth: 438 Typ L1

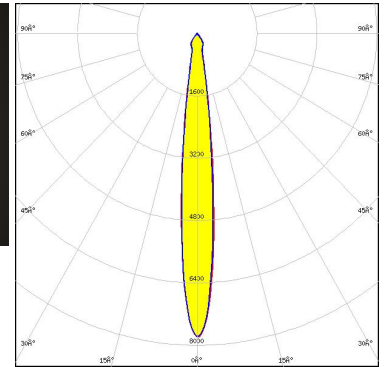

Light distribution files



LED NVCWJ024Z-V1MT: COB J-Type Tunable White
 FWHM / FWTM 12.0° / 25.0°
 Efficiency 92 %
 Peak intensity 9 cd/lm
 LEDs/each optic 1
 Light colour/type White
 Required components:
 C13868_LENINA-STD-BASE-VERO13-18
 Bender Wirth: 498 Typ L2

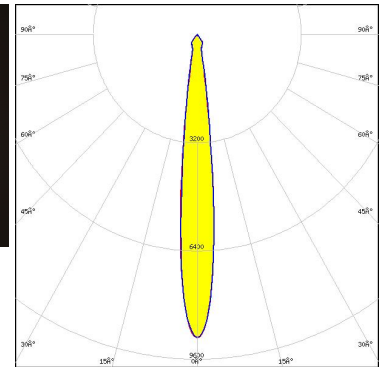

Light distribution files



LED NVCWJ024Z-V1MT: COB J-Type Tunable White
 FWHM / FWTM 14.0° / 32.0°
 Efficiency 88 %
 Peak intensity 6 cd/lm
 LEDs/each optic 1
 Light colour/type White
 Required components:
 C13868_LENINA-STD-BASE-VERO13-18
 C12606_LENINA-DL
 Bender Wirth: 498 Typ L2

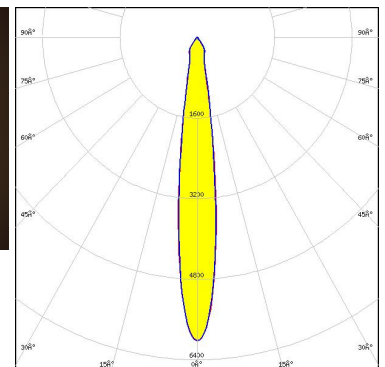
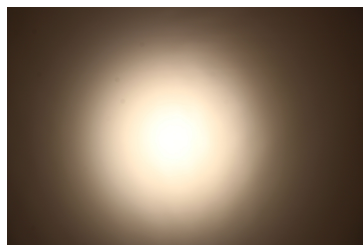

Light distribution files

OPTICAL RESULTS (MEASURED):

OSRAM
Opto Semiconductors

LED Soleriq S13
FWHM / FWTM 14.0° / 28.0°
Efficiency 91 %
Peak intensity 7.2 cd/lm
LEDs/each optic 1
Light colour/type White

Required components:

C13868_LENASTD-BASE-VERO13-18
Bender Wirth: 437 Typ L1

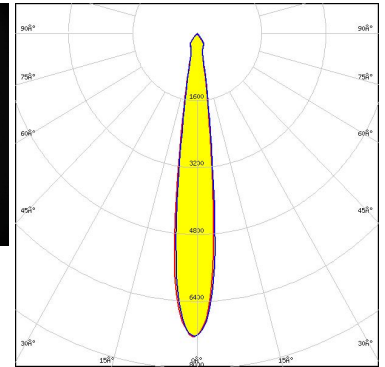

Light distribution files

OSRAM
Opto Semiconductors

LED Soleriq S13
FWHM / FWTM 16.0° / 36.0°
Efficiency 86 %
Peak intensity 5.1 cd/lm
LEDs/each optic 1
Light colour/type White

Required components:

C13868_LENASTD-BASE-VERO13-18
C12606_LENINA-DL
Bender Wirth: 437 Typ L1

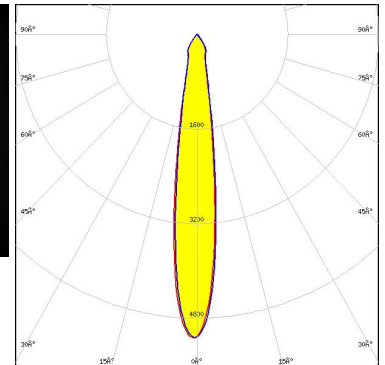
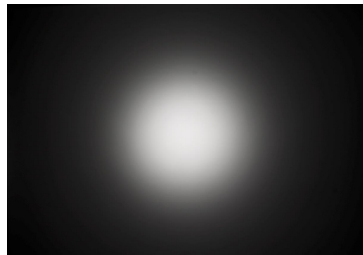

Light distribution files

OSRAM
Opto Semiconductors

LED Soleriq S19
FWHM / FWTM 19.0° / 47.0°
Efficiency 92 %
Peak intensity 4.1 cd/lm
LEDs/each optic 1
Light colour/type White

Required components:

C13867_LENASTD-BASE-VERO29
Bender Wirth: 462 Typ L3

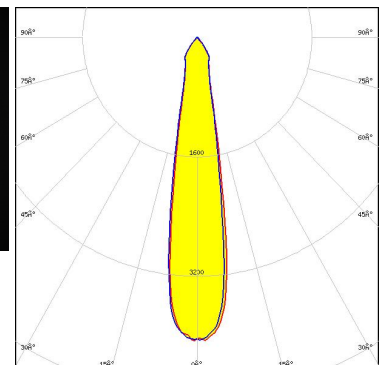

Light distribution files

OPTICAL RESULTS (MEASURED):

OSRAM
Opto Semiconductors

LED Soleriq S19
FWHM / FWTM 20.0° / 53.0°
Efficiency 88 %
Peak intensity 3.7 cd/lm
LEDs/each optic 1
Light colour/type White

Required components:

C13867_LENINA-STD-BASE-VERO29

C12606_LENINA-DL

Bender Wirth: 462 Typ L3

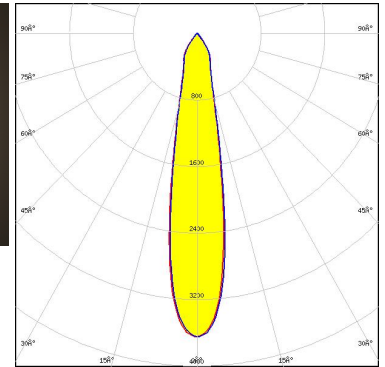
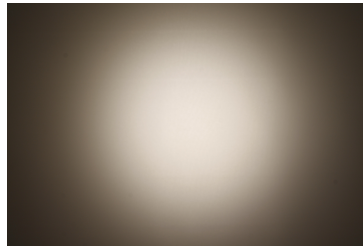

Light distribution files

PHILIPS

LED Fortimo SLM L13 CoB
FWHM / FWTM 15.0° / 34.0°
Efficiency 93 %
Peak intensity 6 cd/lm
LEDs/each optic 1
Light colour/type White

Required components:

C12292_LENINA-STD-BASE-MEZ

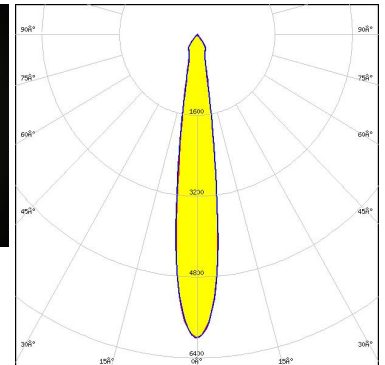
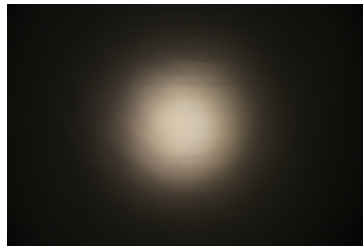

Light distribution files

PHILIPS

LED Fortimo SLM L13 CoB
FWHM / FWTM 18.0° / 49.0°
Efficiency 87 %
Peak intensity 4 cd/lm
LEDs/each optic 1
Light colour/type White

Required components:

C12292_LENINA-STD-BASE-MEZ

C12606_LENINA-DL

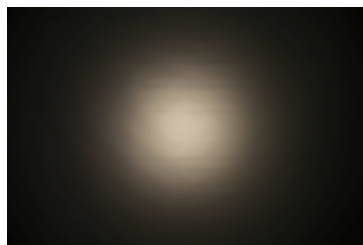

Light distribution files

OPTICAL RESULTS (MEASURED):

PHILIPS

LED Fortimo SLM L15 CoB
FWHM / FWTM 20.0° / 58.0°
Efficiency 86 %
Peak intensity 3.3 cd/lm
LEDs/each optic 1
Light colour/type White
Required components:
C12292_LENINA-STD-BASE-MEZ
C12606_LENINA-DL

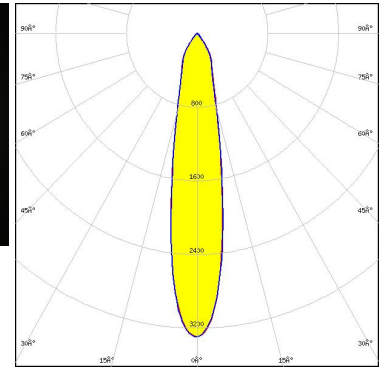
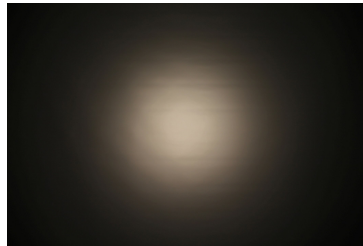

Light distribution files

PHILIPS

LED Fortimo SLM L15 CoB
FWHM / FWTM 18.0° / 42.0°
Efficiency 91 %
Peak intensity 4.7 cd/lm
LEDs/each optic 1
Light colour/type White
Required components:
C12292_LENINA-STD-BASE-MEZ

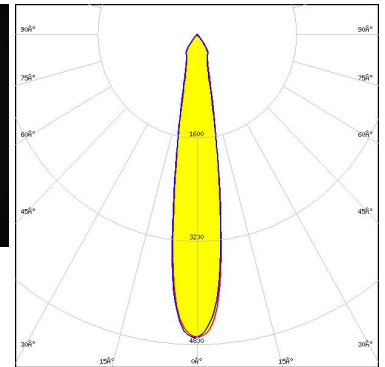
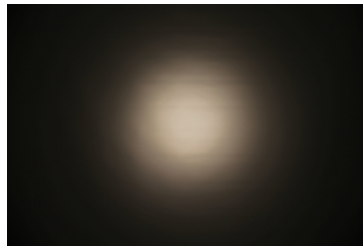

Light distribution files

PHILIPS

LED Fortimo SLM L19 CoB
FWHM / FWTM 22.0° / 64.0°
Efficiency 91 %
Peak intensity 3.2 cd/lm
LEDs/each optic 1
Light colour/type White
Required components:
C12692_LENINA-STD-BASE-CLL040

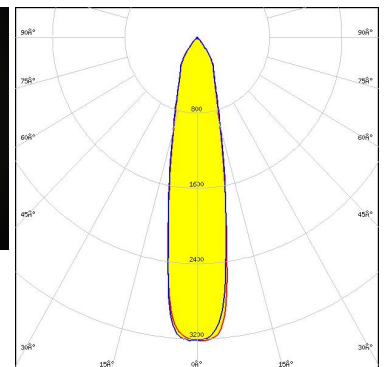
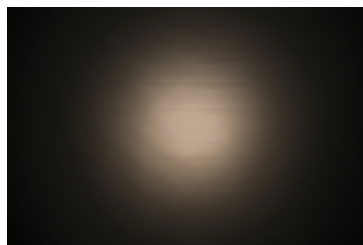

Light distribution files

OPTICAL RESULTS (MEASURED):

PHILIPS

LED Fortimo SLM L19 CoB
FWHM / FWTM 24.0° / 66.0°
Efficiency 86 %
Peak intensity 2.5 cd/lm
LEDs/each optic 1
Light colour/type White
Required components:
C12692_LENINA-STD-BASE-CLL040
C12606_LENINA-DL

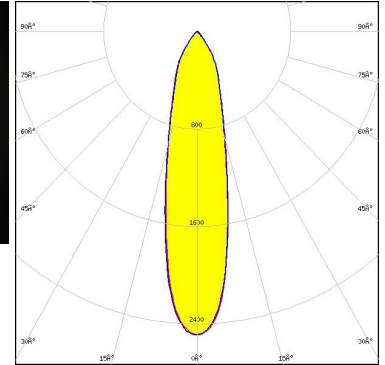

Light distribution files

PHILIPS

LED Fortimo SLM L23 CoB
FWHM / FWTM 29.0° / 70.0°
Efficiency 86 %
Peak intensity 2 cd/lm
LEDs/each optic 1
Light colour/type White
Required components:
C12692_LENINA-STD-BASE-CLL040
C12606_LENINA-DL

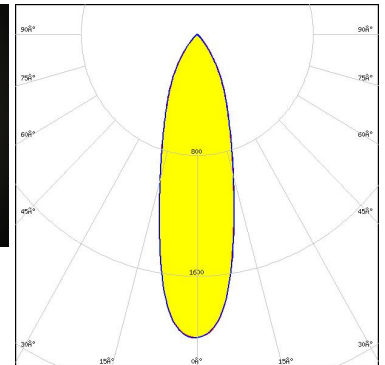
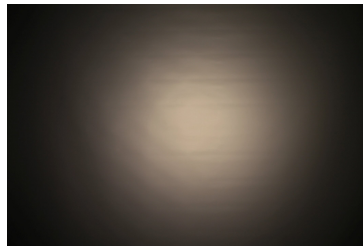

Light distribution files

PHILIPS

LED Fortimo SLM L23 CoB
FWHM / FWTM 27.0° / 69.0°
Efficiency 91 %
Peak intensity 2.4 cd/lm
LEDs/each optic 1
Light colour/type White
Required components:
C12692_LENINA-STD-BASE-CLL040

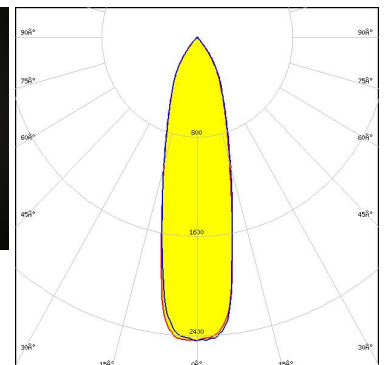
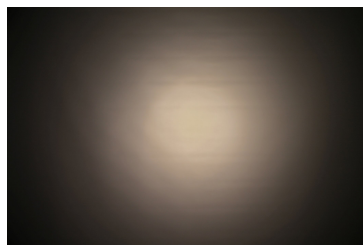

Light distribution files

OPTICAL RESULTS (MEASURED):

SAMSUNG

LED LC016D / LC019D / LC026D / LC033D
 FWHM / FWTM 16.0° / 37.0°
 Efficiency 91 %
 Peak intensity 5.3 cd/lm
 LEDs/each optic 1
 Light colour/type White
 Required components:
 C12691_LENINA-STD-BASE-CLL030

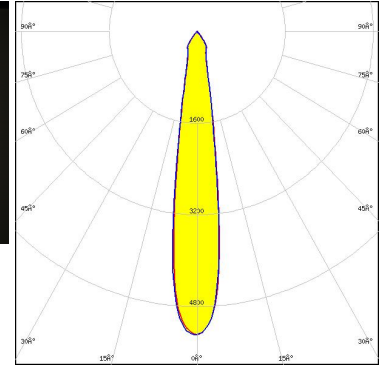

Light distribution files

SAMSUNG

LED LC016D / LC019D / LC026D / LC033D
 FWHM / FWTM 18.0° / 47.0°
 Efficiency 87 %
 Peak intensity 4.1 cd/lm
 LEDs/each optic 1
 Light colour/type White
 Required components:
 C12691_LENINA-STD-BASE-CLL030
 C12606_LENINA-DL

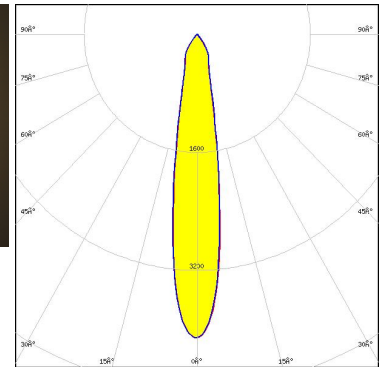
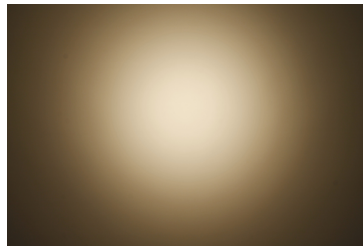

Light distribution files

SAMSUNG

LED LC026B / 033B / 040B
 FWHM / FWTM 20.0° / 48.0°
 Efficiency 91 %
 Peak intensity 4 cd/lm
 LEDs/each optic 1
 Light colour/type White
 Required components:
 C13868_LENINA-STD-BASE-VERO13-18
 Bender Wirth: 450 Typ L2

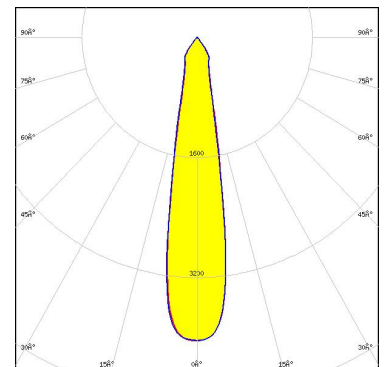

Light distribution files

OPTICAL RESULTS (MEASURED):

SAMSUNG

LED LC026B / 033B / 040B
 FWHM / FWTM 21.0° / 58.0°
 Efficiency 87 %
 Peak intensity 3.3 cd/lm
 LEDs/each optic 1
 Light colour/type White
 Required components:
 C13868_LENINA-STD-BASE-VERO13-18
 C12606_LENINA-DL
 Bender Wirth: 450 Typ L2

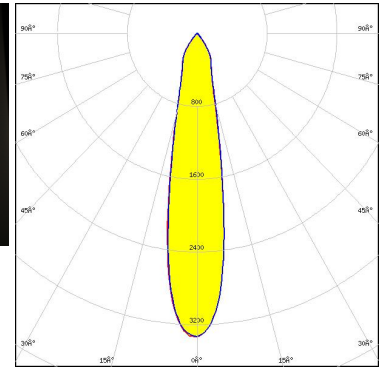

Light distribution files

SAMSUNG

LED LC040D / LC060D / LC080D
 FWHM / FWTM 28.0° / 69.0°
 Efficiency 91 %
 Peak intensity 2.4 cd/lm
 LEDs/each optic 1
 Light colour/type White
 Required components:
 C12692_LENINA-STD-BASE-CLL040

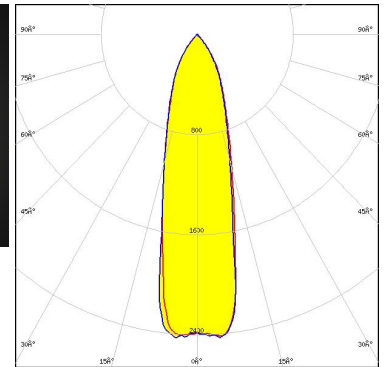
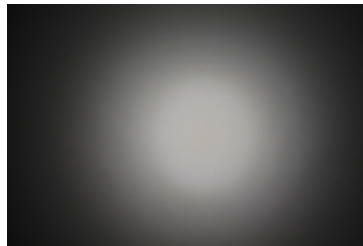

Light distribution files

SAMSUNG

LED LC040D / LC060D / LC080D
 FWHM / FWTM 29.0° / 70.0°
 Efficiency 87 %
 Peak intensity 2.1 cd/lm
 LEDs/each optic 1
 Light colour/type White
 Required components:
 C12692_LENINA-STD-BASE-CLL040
 C12606_LENINA-DL

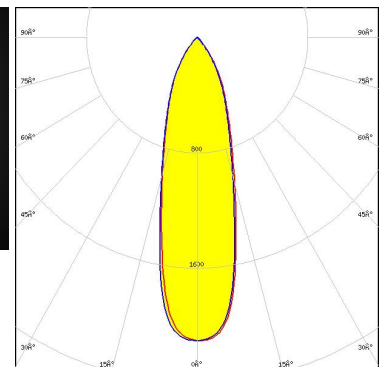
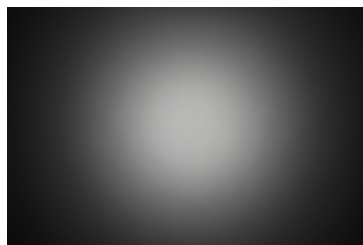

Light distribution files

OPTICAL RESULTS (MEASURED):

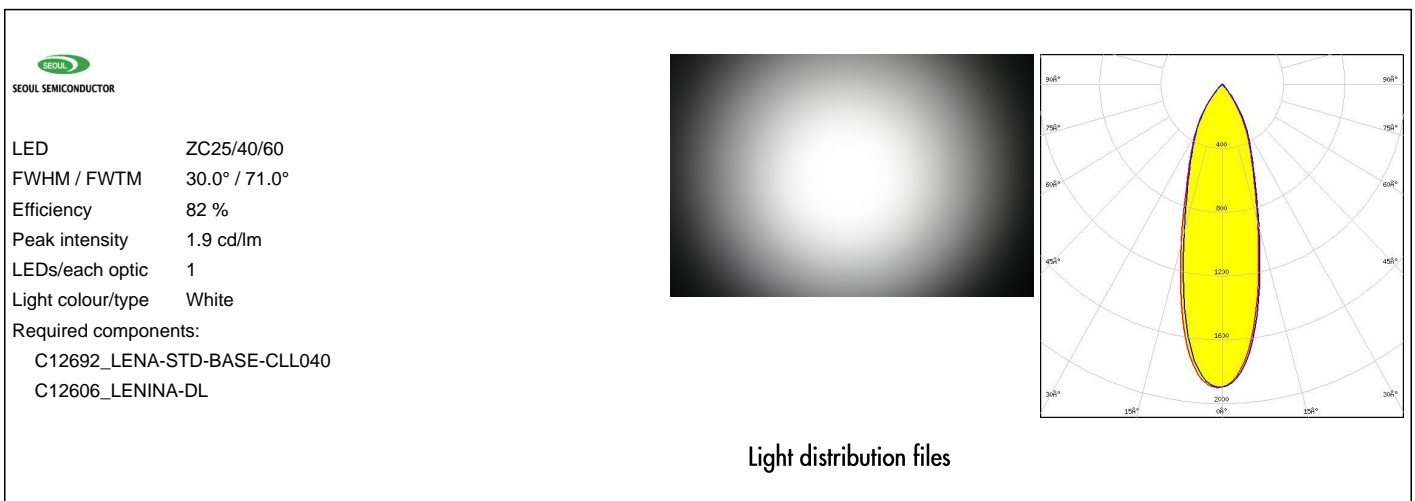
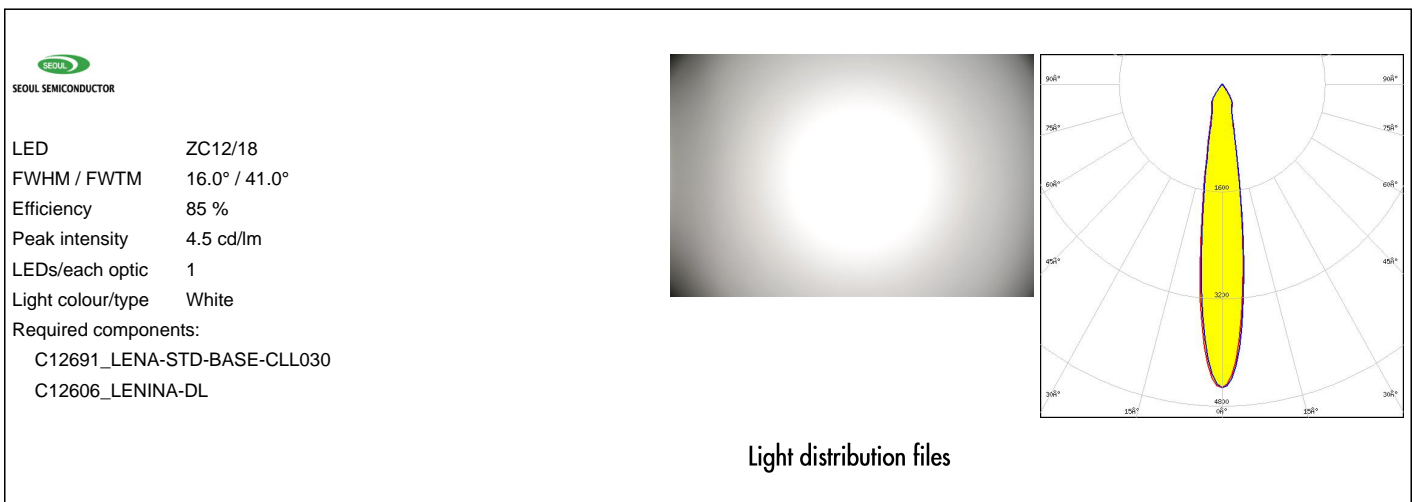
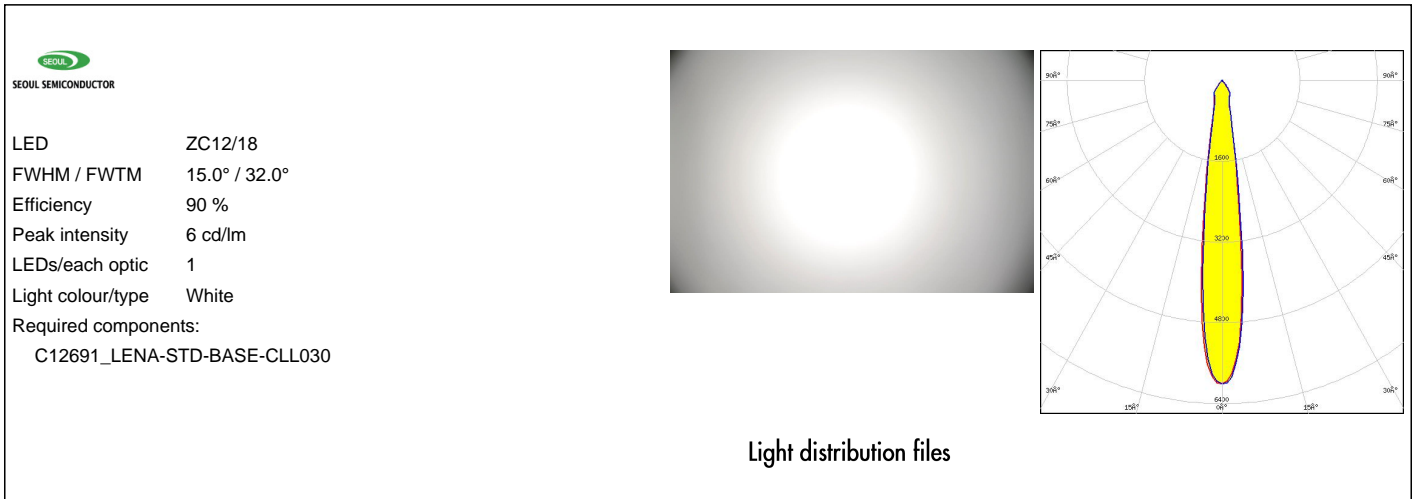

OPTICAL RESULTS (MEASURED):

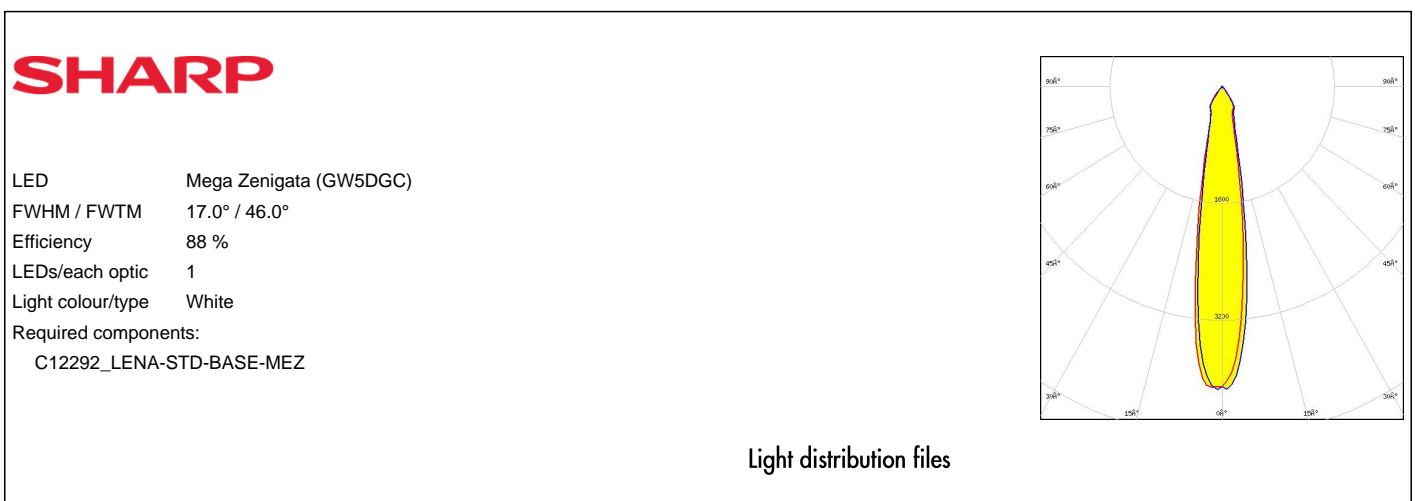
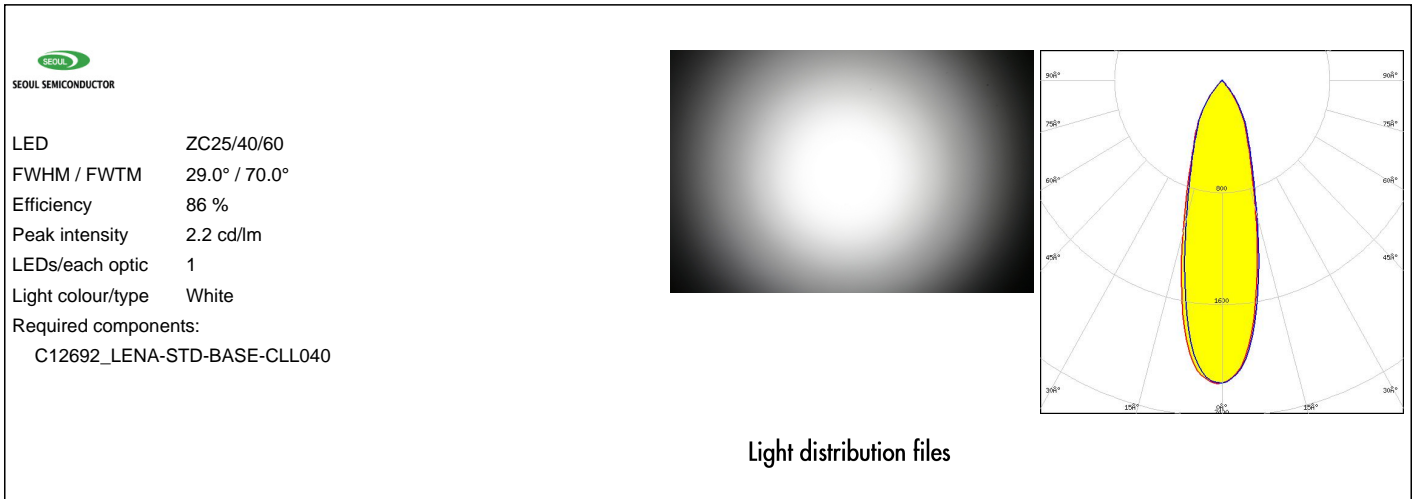

OPTICAL RESULTS (MEASURED):

SHARP

LED Mega Zenigata (GW6DME)
 FWHM / FWTM 21.0° / 60.0°
 Efficiency 83 %
 Peak intensity 3.2 cd/lm
 LEDs/each optic 1
 Light colour/type White
 Required components:
 C12292_LENINA-STD-BASE-MEZ
 C12606_LENINA-DL

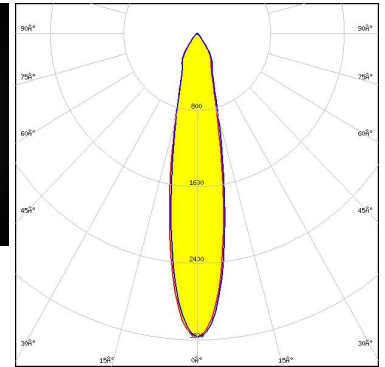

Light distribution files

SHARP

LED Mega Zenigata (GW6DME)
 FWHM / FWTM 19.0° / 47.0°
 Efficiency 88 %
 Peak intensity 3.9 cd/lm
 LEDs/each optic 1
 Light colour/type White
 Required components:
 C12292_LENINA-STD-BASE-MEZ

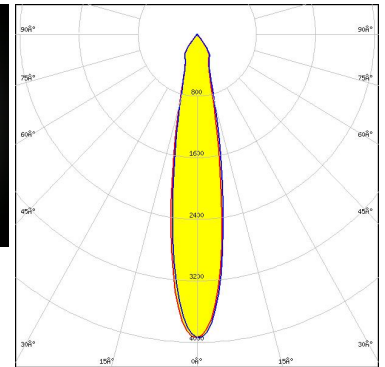

Light distribution files

TRIDONIC

LED SLE G7 LES15
 FWHM / FWTM 16.0° / 36.0°
 Efficiency 93 %
 Peak intensity 5.6 cd/lm
 LEDs/each optic 1
 Light colour/type White
 Required components:
 C12691_LENINA-STD-BASE-CLL030

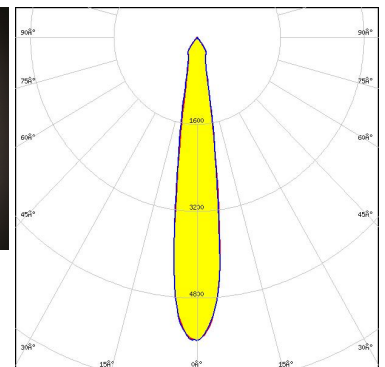
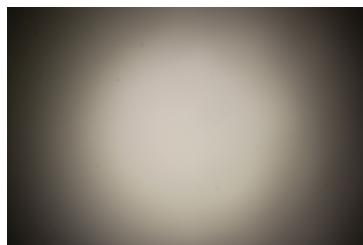

Light distribution files

OPTICAL RESULTS (MEASURED):

TRIDONIC

LED SLE G7 LES17 H
FWHM / FWMTM 19.0° / 46.0°
Efficiency 91 %
Peak intensity 4.3 cd/lm
LEDs/each optic 1
Light colour/type White
Required components:
C14547_LENINA-ADAPTER-B

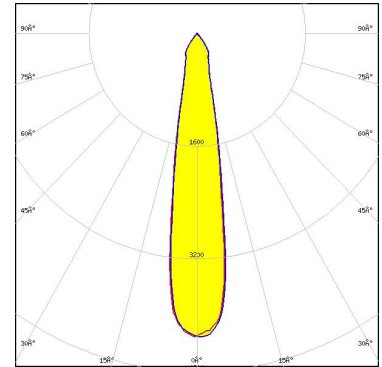

Light distribution files

TRIDONIC

LED SLE G7 LES21 H
FWHM / FWMTM 24.0° / 65.0°
Efficiency 91 %
Peak intensity 2.9 cd/lm
LEDs/each optic 1
Light colour/type White
Required components:
C14547_LENINA-ADAPTER-B

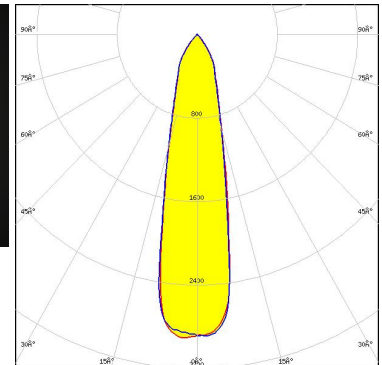
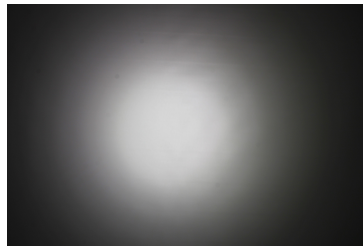

Light distribution files

XICATO

LED XOB 14.5 mm
FWHM / FWMTM 16.0° / 34.0°
Efficiency 93 %
Peak intensity 5.9 cd/lm
LEDs/each optic 1
Light colour/type White
Required components:
C12691_LENINA-STD-BASE-CLL030

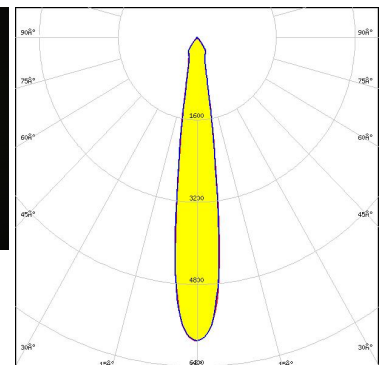
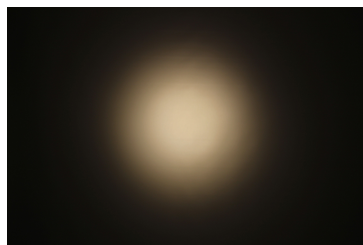

Light distribution files

OPTICAL RESULTS (SIMULATED):

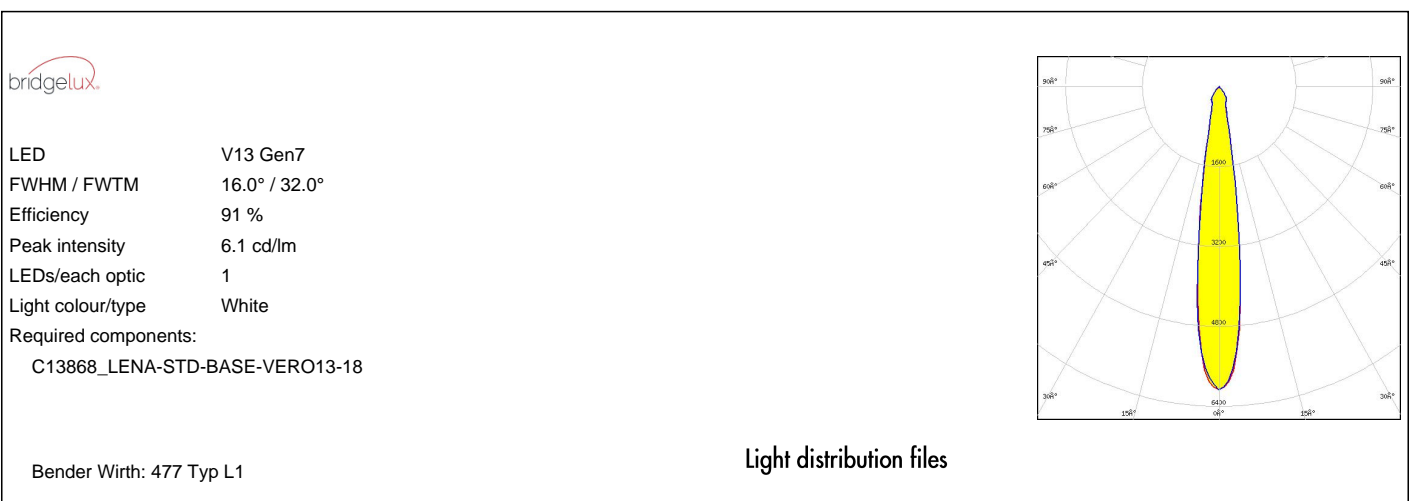
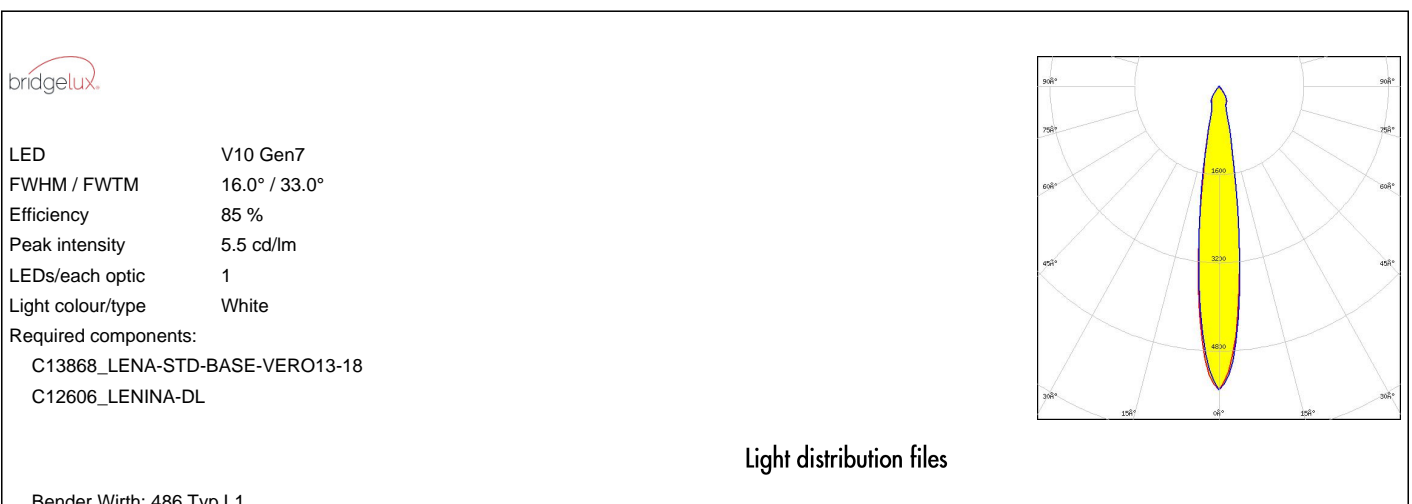
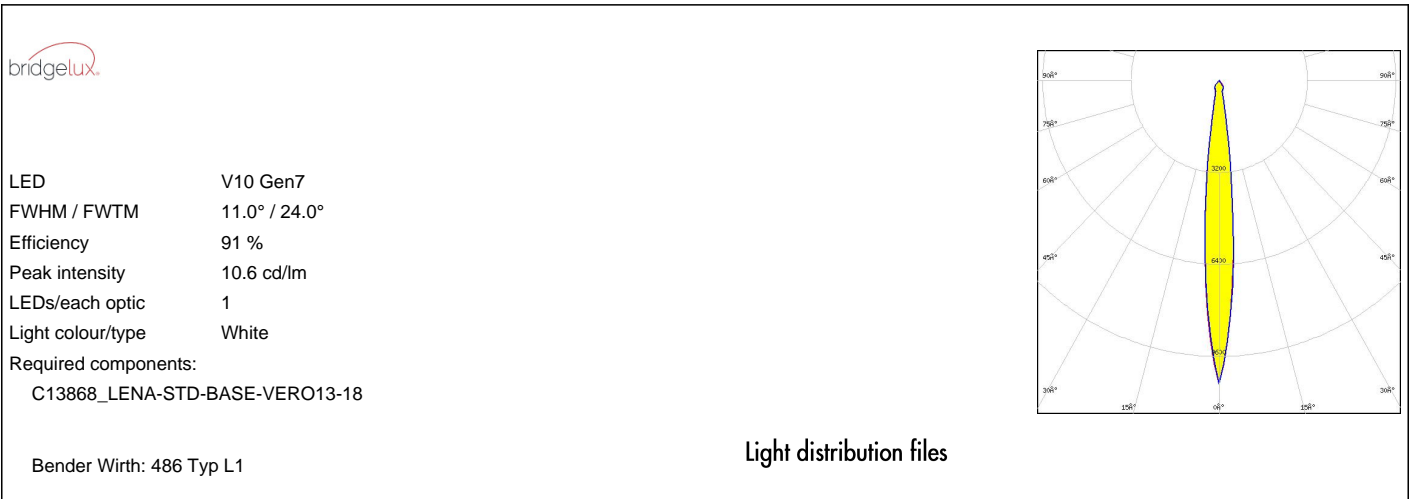

OPTICAL RESULTS (SIMULATED):



LED V13 Gen7
FWHM / FWTM 18.0° / 41.0°
Efficiency 86 %
Peak intensity 4.5 cd/lm
LEDs/each optic 1
Light colour/type White
Required components:
 C13868_LENINA-STD-BASE-VERO13-18
 C12606_LENINA-DL

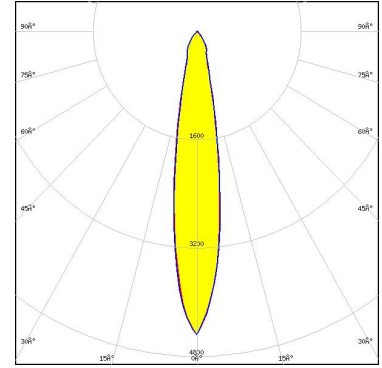

Light distribution files

Bender Wirth: 477 Typ L1



LED V13 Gen7
FWHM / FWTM 18.0° / 52.0°
Efficiency 90 %
Peak intensity 4.1 cd/lm
LEDs/each optic 1
Light colour/type White
Required components:

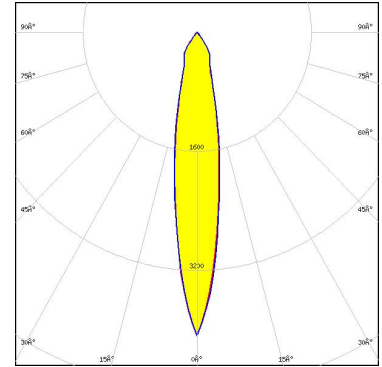

Light distribution files

IDEAL: 50-2103CT + 50-2100AN



LED V13 Gen7
FWHM / FWTM 22.0° / 62.0°
Efficiency 87 %
Peak intensity 3 cd/lm
LEDs/each optic 1
Light colour/type White
Required components:
 C12606_LENINA-DL

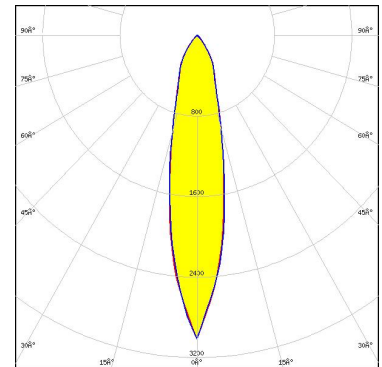

Light distribution files

IDEAL: 50-2103CT + 50-2100AN

OPTICAL RESULTS (SIMULATED):

bridgelux

LED V22 Gen 8-9
 FWHM / FWTM 24.0° / 66.0°
 Efficiency 90 %
 Peak intensity 2.9 cd/lm
 LEDs/each optic 1
 Light colour/type White

Required components:
 C13867_LENINA-STD-BASE-VERO29

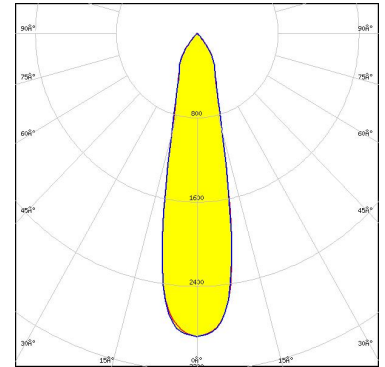

Bender Wirth: 431 Typ L3

Light distribution files

bridgelux

LED V22 Gen7
 FWHM / FWTM 27.0° / 70.0°
 Efficiency 90 %
 Peak intensity 2.7 cd/lm
 LEDs/each optic 1
 Light colour/type White

Required components:
 C13867_LENINA-STD-BASE-VERO29

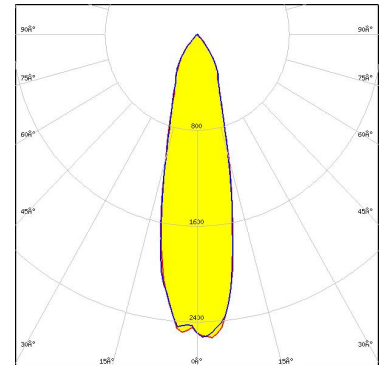

Bender Wirth: 431 Typ L3

Light distribution files

bridgelux

LED V22 Gen7
 FWHM / FWTM 26.0° / 68.0°
 Efficiency 87 %
 Peak intensity 2.5 cd/lm
 LEDs/each optic 1
 Light colour/type White

Required components:
 C13867_LENINA-STD-BASE-VERO29
 C12606_LENINA-DL

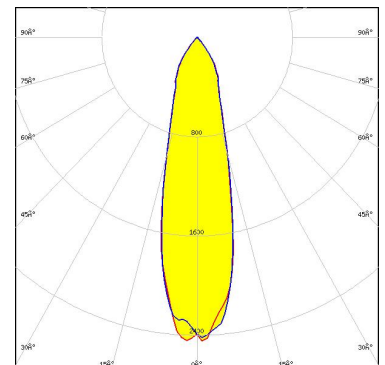

Bender Wirth: 431 Typ L3

Light distribution files

OPTICAL RESULTS (SIMULATED):

CITIZEN

LED CLL03x/CLU03x
 FWHM / FWTM 16.0° / 34.0°
 Efficiency 87 %
 Peak intensity 5.6 cd/lm
 LEDs/each optic 1
 Light colour/type White
 Required components:
 C12691_LENINA-STD-BASE-CLL030

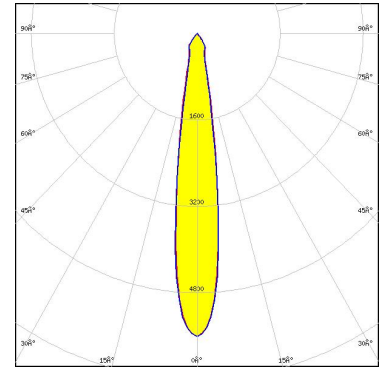

Light distribution files



LED CXA/B 13xx
 FWHM / FWTM 15.0° / 31.0°
 Efficiency 91 %
 Peak intensity 6.6 cd/lm
 LEDs/each optic 1
 Light colour/type White
 Required components:
 C13868_LENINA-STD-BASE-VERO13-18
 C12606_LENINA-DL

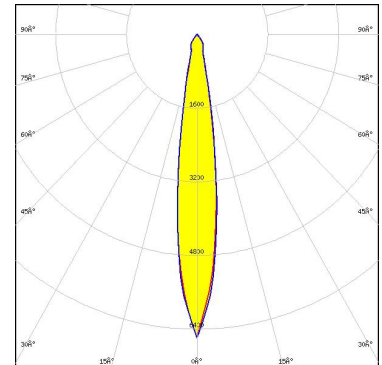

Light distribution files

Bender Wirth: 448 Typ L1



LED CXA/B 13xx
 FWHM / FWTM 12.0° / 21.0°
 Efficiency 94 %
 Peak intensity 11.8 cd/lm
 LEDs/each optic 1
 Light colour/type White
 Required components:
 C13868_LENINA-STD-BASE-VERO13-18

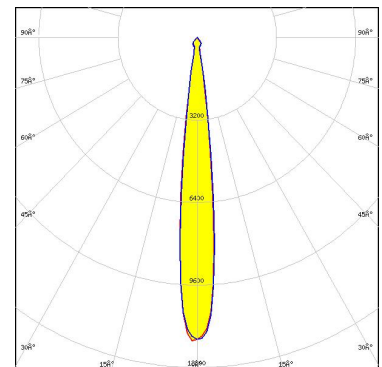

Light distribution files

Bender Wirth: 448 Typ L1

OPTICAL RESULTS (SIMULATED):



LED CXA/B 1830
 FWHM / FWTM 19.0° / 52.0°
 Efficiency 84 %
 Peak intensity 3.6 cd/lm
 LEDs/each optic 1
 Light colour/type White

Required components:

C14146_LENINA-STD-BASE-CXA18
 C12606_LENINA-DL

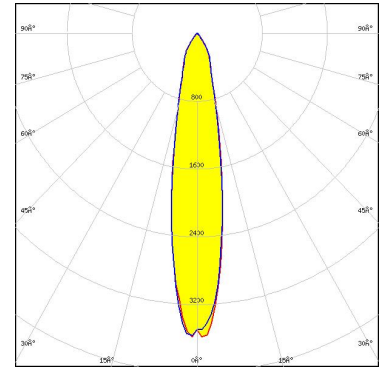

Light distribution files



LED CXA/B 1830
 FWHM / FWTM 16.0°
 Efficiency 93 %
 Peak intensity 5.6 cd/lm
 LEDs/each optic 1
 Light colour/type White

Required components:

C14146_LENINA-STD-BASE-CXA18

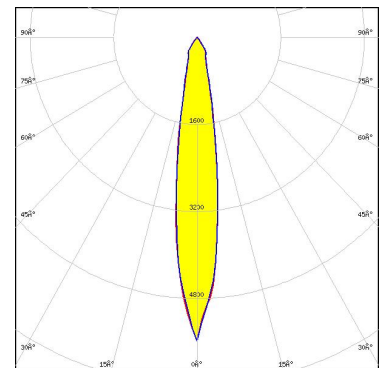

Light distribution files



LED CXA/B 30xx
 FWHM / FWTM 19.0° / 58.0°
 Efficiency 84 %
 Peak intensity 3.3 cd/lm
 LEDs/each optic 1
 Light colour/type White

Required components:

C12606_LENINA-DL

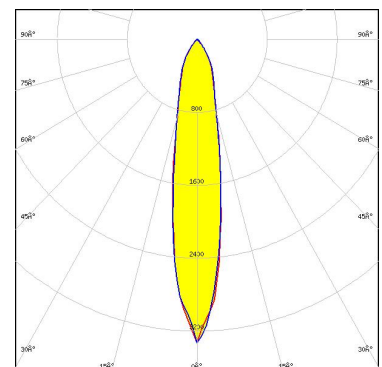

Light distribution files

IDEAL: 50-2234C + 50-2100LN

OPTICAL RESULTS (SIMULATED):



LED CXA/B 30xx
FWHM / FWTM 18.0° / 53.0°
Efficiency 90 %
Peak intensity 4 cd/lm
LEDs/each optic 1
Light colour/type White
Required components:

IDEAL: 50-2234C + 50-2100LN

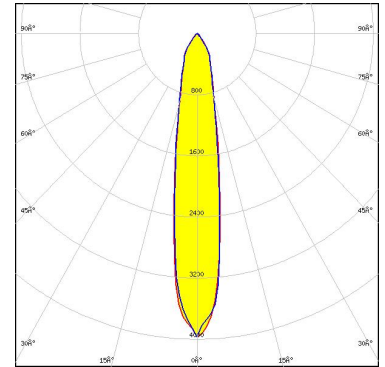

Light distribution files



LED CxM-14 (19x19)
FWHM / FWTM 17.0° / 94.0°
Efficiency 91 %
Peak intensity 5.5 cd/lm
LEDs/each optic 1
Light colour/type White
Required components:

C13868_LENINA-STD-BASE-VERO13-18

Bender Wirth: 433 Typ L1

Light distribution files



LED CxM-14 (19x19)
FWHM / FWTM 17.0° / 41.0°
Efficiency 87 %
Peak intensity 4.5 cd/lm
LEDs/each optic 1
Light colour/type White
Required components:

C13868_LENINA-STD-BASE-VERO13-18

C12606_LENINA-DL

Bender Wirth: 433 Typ L1

Light distribution files

OPTICAL RESULTS (SIMULATED):



LED CxM-9 (13.5x13.5)
FWHM / FWTM 11.0° / 22.0°
Efficiency 91 %
Peak intensity 10.9 cd/lm
LEDs/each optic 1
Light colour/type White

Required components:

C13868_LENINA-STD-BASE-VERO13-18

Bender Wirth: 434 Typ L1

[Light distribution files](#)



LED CxM-9 (13.5x13.5)
FWHM / FWTM 13.0° / 28.0°
Efficiency 86 %
Peak intensity 6.9 cd/lm
LEDs/each optic 1
Light colour/type White

Required components:

C13868_LENINA-STD-BASE-VERO13-18

C12606_LENINA-DL

Bender Wirth: 434 Typ L1

[Light distribution files](#)



LED Soleriq S15
FWHM / FWTM 20.0° / 56.0°
Efficiency 91 %
Peak intensity 3.7 cd/lm
LEDs/each optic 1
Light colour/type White

Required components:

C12691_LENINA-STD-BASE-CLL030

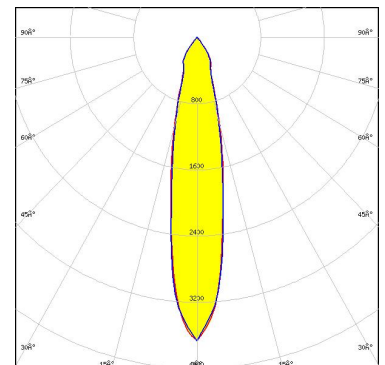

[Light distribution files](#)

OPTICAL RESULTS (SIMULATED):

 SEOL SEMICONDUCTOR	
LED	ZC12/18
FWHM / FWTM	17.0° / 41.0°
Efficiency	87 %
Peak intensity	4.5 cd/lm
LEDs/each optic	1
Light colour/type	White
Required components:	
C13868_LENA-STD-BASE-VERO13-18	
C12606_LENINA-DL	
Bender Wirth: 433 Typ L1	

 SEOL SEMICONDUCTOR	
LED	ZC12/18
FWHM / FWTM	17.0° / 34.0°
Efficiency	91 %
Peak intensity	5.5 cd/lm
LEDs/each optic	1
Light colour/type	White
Required components:	
C13868_LENA-STD-BASE-VERO13-18	
Bender Wirth: 433 Typ L1	

 SEOL SEMICONDUCTOR	
LED	ZC4/6
FWHM / FWTM	13.0° / 28.0°
Efficiency	86 %
Peak intensity	6.9 cd/lm
LEDs/each optic	1
Light colour/type	White
Required components:	
C13868_LENA-STD-BASE-VERO13-18	
C12606_LENINA-DL	
Bender Wirth: 434 Typ L1	

OPTICAL RESULTS (SIMULATED):

 SEOL SEMICONDUCTOR	
LED	ZC4/6
FWHM / FWTM	11.0° / 22.0°
Efficiency	91 %
Peak intensity	10.9 cd/m
LEDs/each optic	1
Light colour/type	White
Required components: C13868_LENINA-STD-BASE-VERO13-18	
Bender Wirth: 434 Typ L1	

GENERAL INFORMATION:

NOTE: The typical beam angle will be changed by different color, chip size and chip position tolerance. The typical total beam angle is the full angle measured where the luminous intensity is half of the peak value.

Due to use of high power COB's with this product, special attention to proper thermal design is highly recommended. LEDiL has no liability for direct, indirect or consecutive damages arising from the LEDiL products being used outside of the recommended temperature range.

MATERIALS:

As part of our continuous research and improvement processes, and to ensure the best possible quality and availability of our products, LEDiL reserves the right to change material grades without notice.

PRODUCT DATA USER AGREEMENT AND DISCLAIMER:

The measured data in the provided downloadable LEDiL Product Datasheets and Mechanical 2D-Drawings is rounded and provided as reference for planning. LEDiL Oy's optical specifications have been verified by conducting performance testing of the products in accordance with the company's quality system. The reported data are averaged results of multiple measurements with typical variation. LEDiL Oy reserves the right to without prior notification make changes and improvements to its products.

LEDiL Oy assumes neither warranty, nor guarantee nor any other liability of any kind for the contents and correctness of the provided data. The provided data has been generated with highest diligence but the provided data may in reality not represent the complete possible variation range of all intrinsic parameters. Therefore, in certain cases a deviation from the provided data could occur.

LEDiL Oy reserves the right to undertake technical changes of its products without further notification which could lead to changes in the provided data. LEDiL Oy assumes no liability of any kind for the possible deviation from any provided data or any other damage resulting from the usage of the provided data.

The user agrees to this disclaimer and user agreement with the download or usage of the provided files.

LEDiL Oy

Joensuunkatu 13
FI-24240 SALO
Finland

LEDiL Inc.

228 West Page Street
Suite D
Sycamore IL 60178
USA

Ledil Optics Technology (Shenzhen) Co., Ltd.

405 , Block B
Casic Motor Building
Shenzhen 518057
P.R.CHINA

Local sales and technical support

[www.ledil.com/
where_to_buy](http://www.ledil.com/where_to_buy)

Shipping locations

Poznan, Poland
Hong Kong, China

Distribution Partners

[www.ledil.com/
where_to_buy](http://www.ledil.com/where_to_buy)