

### RONDA-ZT45

Double asymmetric beam for wall-washing and aisle lighting with holder A compatible with 3rd party connectors from TE, Bender+Wirth and IDEAL

#### SPECIFICATION:

Dimensions	Ø 69.9 mm
Height	15 mm
Fastening	socket
ROHS compliant	yes ⓘ



#### MATERIALS:

Component	Type	Material	Colour	Finish	Length
F15159_RONDA-ZT45	Single lens	PMMA	clear		49.9
F15155_RONDA-HLD-A	Holder	PC	white		69.9

#### ORDERING INFORMATION:

##### Quantities for one set:

Single lens	1
Holder	1

Component		Qty in box	MOQ	MPQ	Box weight (kg)
F15159_RONDA-ZT45	Single lens	420	120	30	6.5
» Box size: 480 x 280 x 300 mm					
F15155_RONDA-HLD-A	Holder	420	120	30	4.4
» Box size: 480 x 280 x 300 mm					

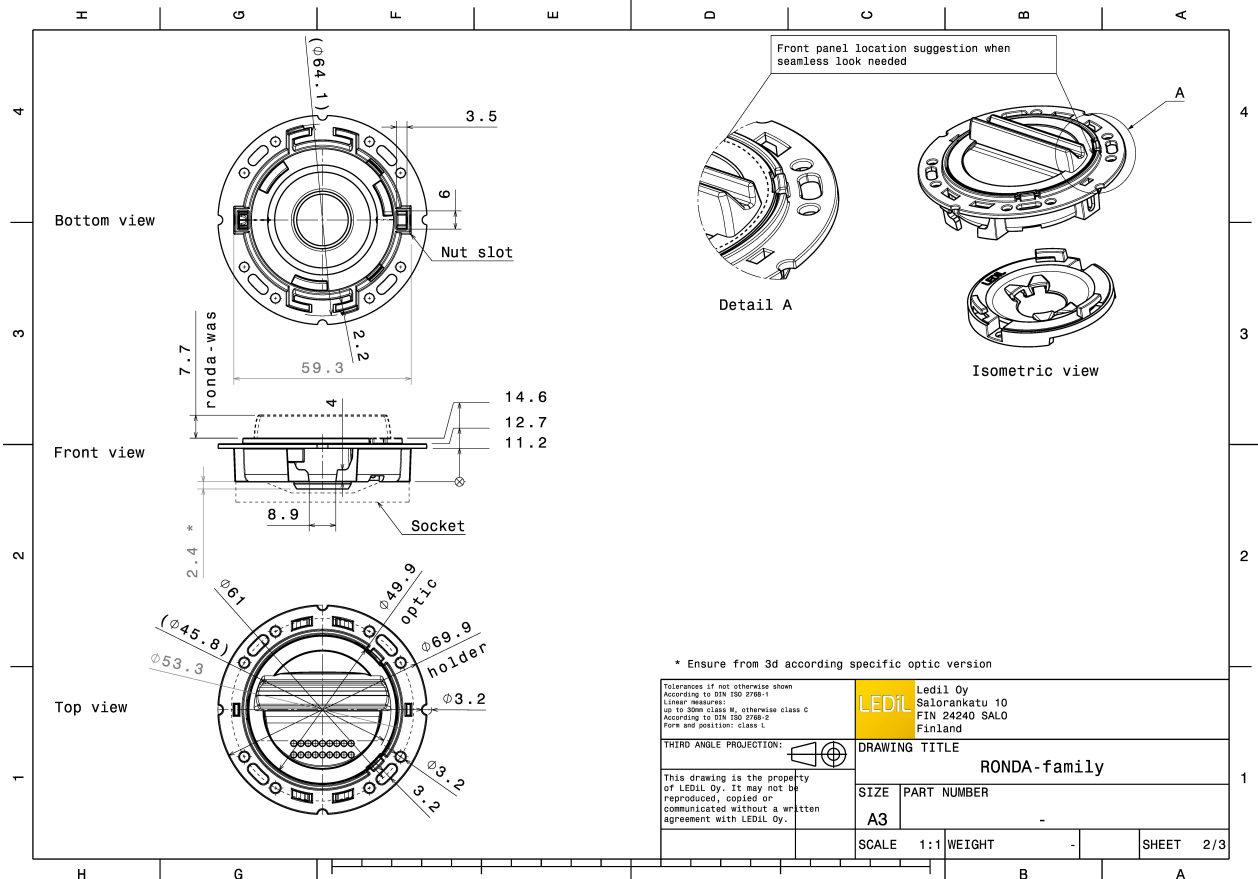
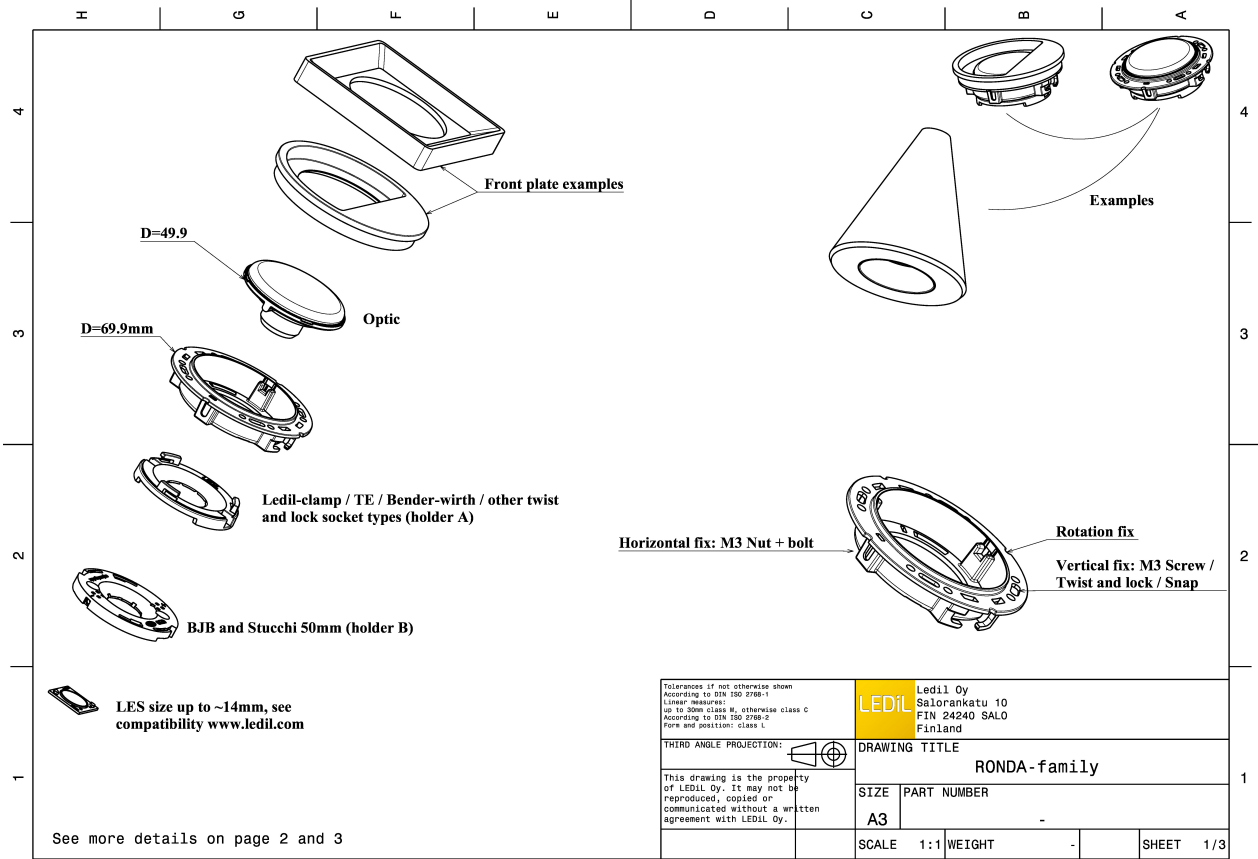

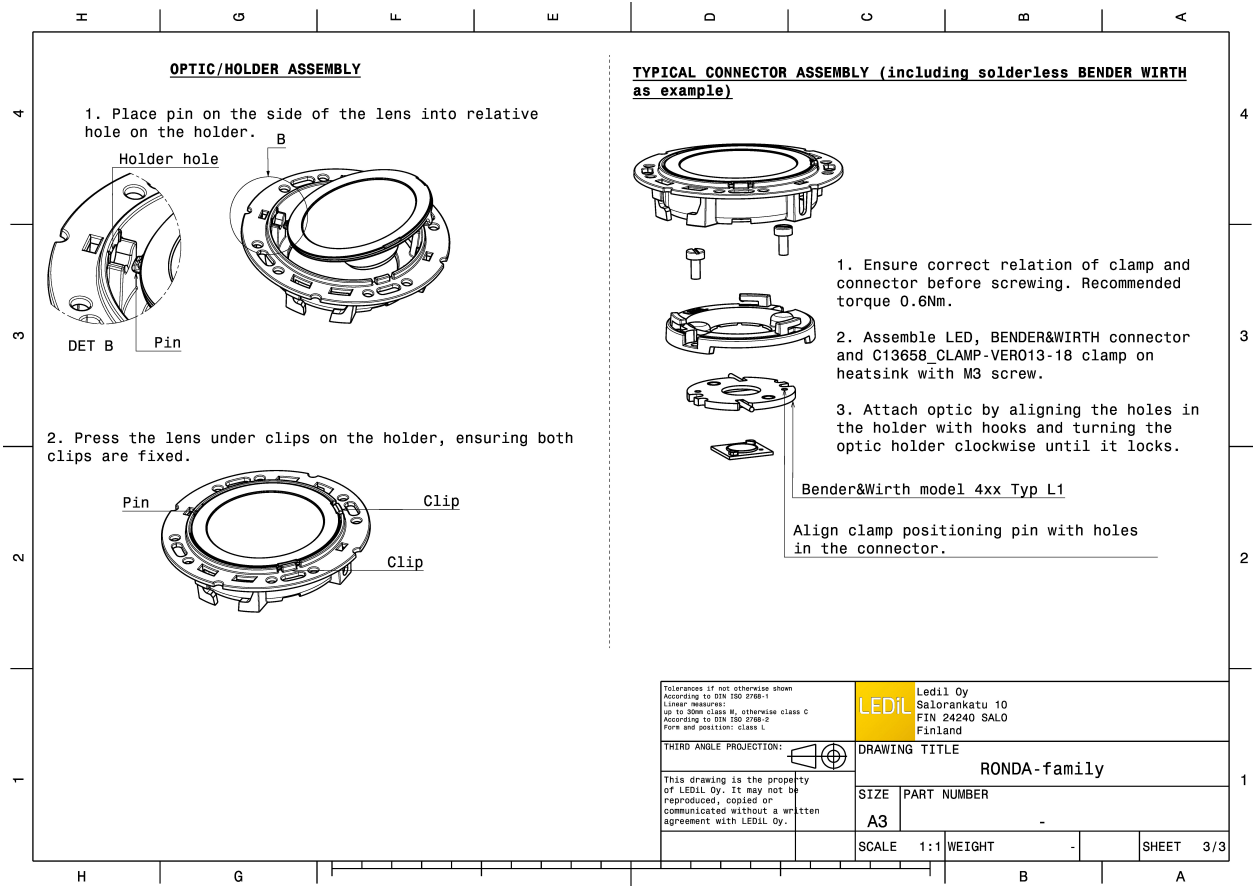

See also our general installation guide: [www.ledil.com/installation\\_guide](http://www.ledil.com/installation_guide)



### OPTICAL RESULTS (MEASURED):

bridgelux

LED V10 Gen7  
 FWHM / FWTM Asymmetric  
 Efficiency 88 %  
 Peak intensity 0.6 cd/lm  
 LEDs/each optic 1  
 Light colour/type White

Required components:

C13658\_CLAMP-VERO13-18  
 Bender Wirth: 486 Typ L1

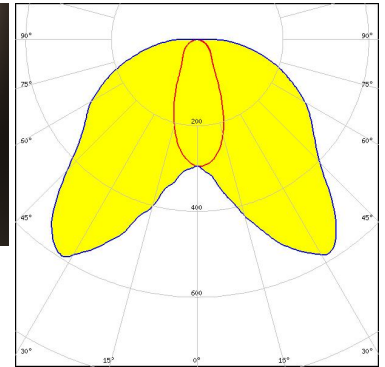
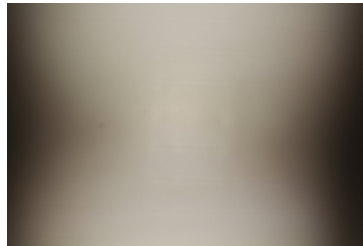

Light distribution files

bridgelux

LED V13 Gen7  
 FWHM / FWTM Asymmetric  
 Efficiency 83 %  
 Peak intensity 0.4 cd/lm  
 LEDs/each optic 1  
 Light colour/type White

Required components:

TE Connectivity: 2213254-2 + OPTIC CLIP Z50 TYPE1 2213194-1

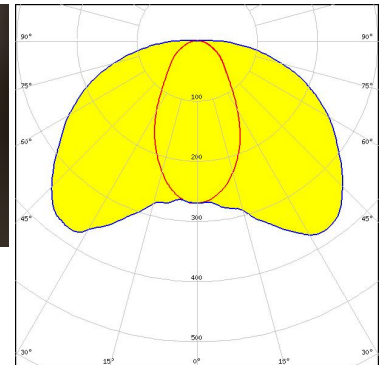
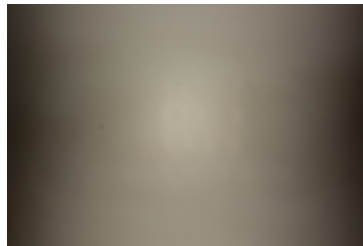

Light distribution files

bridgelux

LED Vero SE 13  
 FWHM / FWTM Asymmetric  
 Efficiency 88 %  
 Peak intensity 0.4 cd/lm  
 LEDs/each optic 1  
 Light colour/type White

Required components:

C16402\_CLAMP-VEROSE-13-18

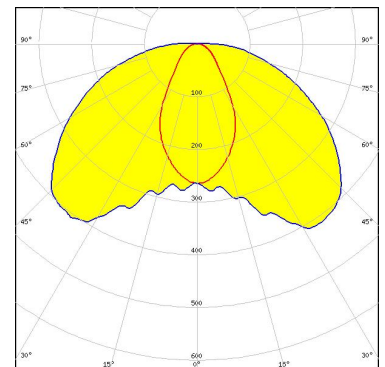

Light distribution files

### OPTICAL RESULTS (MEASURED):

bridgelux

LED VERO13  
 FWHM / FWTM Asymmetric  
 Efficiency 89 %  
 Peak intensity 0.4 cd/lm  
 LEDs/each optic 1  
 Light colour/type White  
 Required components:  
 C13658\_CLAMP-VERO13-18

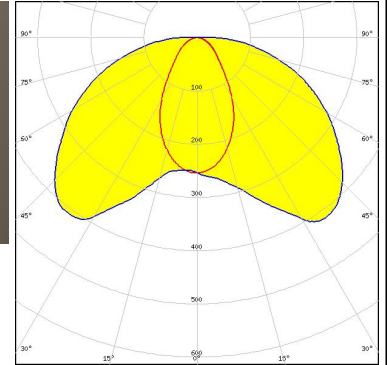

Light distribution files

### CITIZEN

LED CLL03x/CLU03x  
 FWHM / FWTM Asymmetric  
 Efficiency 83 %  
 Peak intensity 0.4 cd/lm  
 LEDs/each optic 1  
 Light colour/type White  
 Required components:  
 IDEAL: 50-2103CT + 50-2100AN

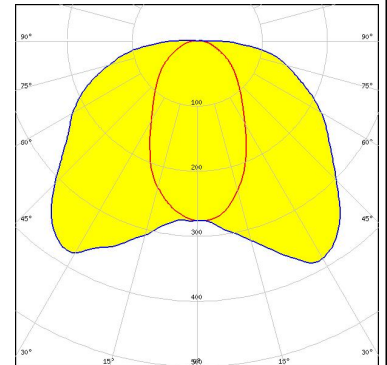

Light distribution files

### CITIZEN

LED CLL03x/CLU03x  
 FWHM / FWTM Asymmetric  
 Efficiency 86 %  
 Peak intensity 0.4 cd/lm  
 LEDs/each optic 1  
 Light colour/type White  
 Required components:  
 C16791\_CLAMP-Z45-A  
 TE Connectivity: 2325807-3

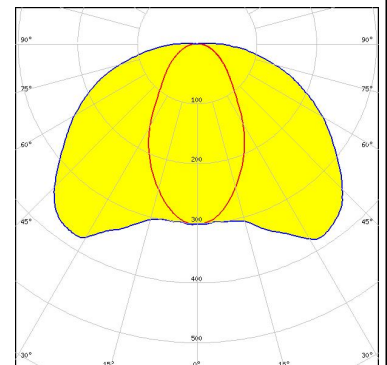

Light distribution files

### OPTICAL RESULTS (MEASURED):

#### CITIZEN

LED CLL04x/CLU04x  
FWHM / FWTM Asymmetric  
Efficiency 84 %  
Peak intensity 0.4 cd/lm  
LEDs/each optic 1  
Light colour/type White  
Required components:  
IDEAL: 50-2204-CT + 50-2100AN

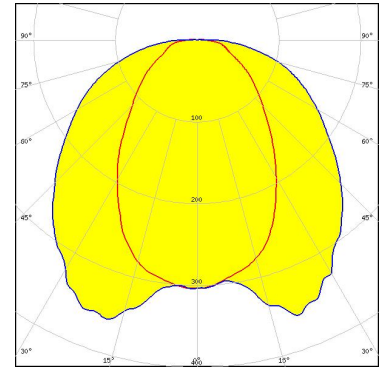

Light distribution files

#### CITIZEN

LED CLU730/731/733  
FWHM / FWTM Asymmetric  
Efficiency 85 %  
Peak intensity 0.4 cd/lm  
LEDs/each optic 1  
Light colour/type White  
Required components:  
IDEAL: 50-2204-CT + 50-2100AN

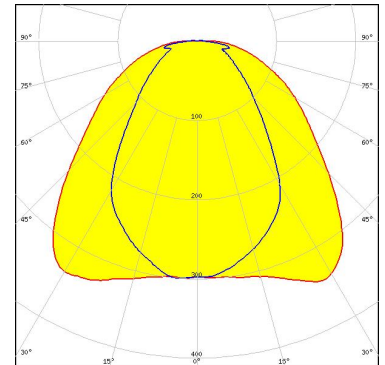

Light distribution files



LED CMA1840  
FWHM / FWTM Asymmetric  
Efficiency 89 %  
Peak intensity 0.4 cd/lm  
LEDs/each optic 1  
Light colour/type White  
Required components:  
C14123\_CLAMP-CXA15-18

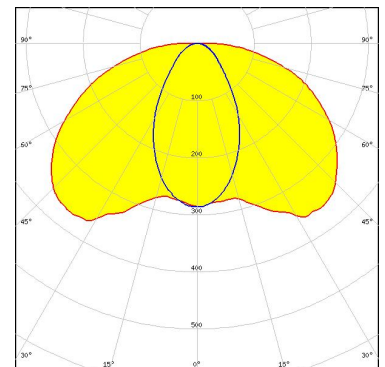

Light distribution files

### OPTICAL RESULTS (MEASURED):



LED CXA/B 1816 & CXA/B 1820 & CXA 1850  
FWHM / FWTM Asymmetric  
Efficiency 87 %  
Peak intensity 0.4 cd/lm  
LEDs/each optic 1  
Light colour/type White  
Required components:  
TE Connectivity: 2213401-2 + OPTIC CLIP Z50 TYPE1 2213194-1

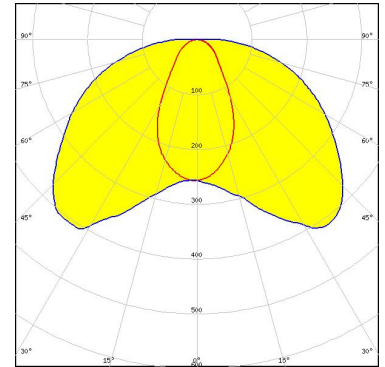

Light distribution files



LED CXA/B 1816 & CXA/B 1820 & CXA 1850  
FWHM / FWTM Asymmetric  
Efficiency 90 %  
Peak intensity 0.4 cd/lm  
LEDs/each optic 1  
Light colour/type White  
Required components:  
C14123\_CLAMP-CXA15-18

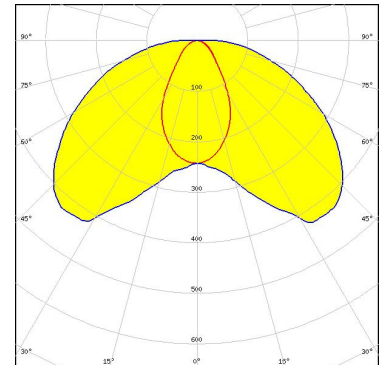

Light distribution files



LED COB J-Type  
FWHM / FWTM Asymmetric  
Efficiency 83 %  
Peak intensity 0.8 cd/lm  
LEDs/each optic 1  
Light colour/type White  
Required components:  
IDEAL: 50-2103NC + 50-2100AN

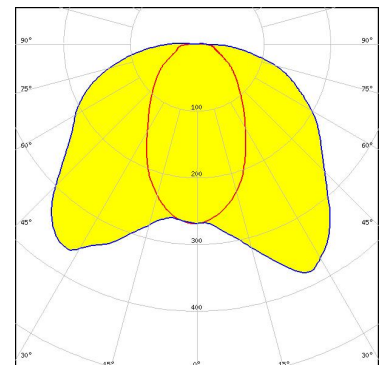

Light distribution files

### OPTICAL RESULTS (MEASURED):



LED COB L-Type (LES 11)  
FWHM / FWTM Asymmetric  
Efficiency 87 %  
Peak intensity 0.5 cd/lm  
LEDs/each optic 1  
Light colour/type White  
Required components:  
TE Connectivity: 2213382-2 + OPTIC CLIP Z50 TYPE1 2213194-1

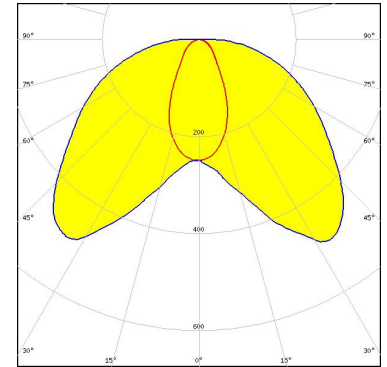

Light distribution files



LED COB L-Type (LES 11)  
FWHM / FWTM Asymmetric  
Efficiency 84 %  
Peak intensity 0.5 cd/lm  
LEDs/each optic 1  
Light colour/type White  
Required components:  
IDEAL: 50-2100NC + 50-2100AN

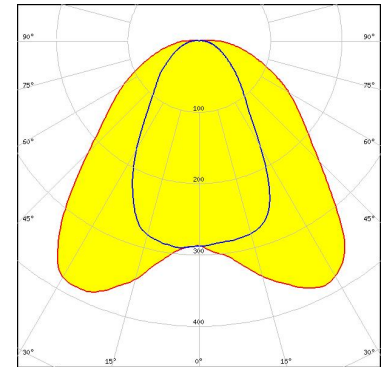

Light distribution files



LED PrevaLED Core G7 L15 H1  
FWHM / FWTM Asymmetric  
Efficiency 78 %  
Peak intensity 0.4 cd/lm  
LEDs/each optic 1  
Light colour/type White  
Required components:  
C16685\_CLAMP-PRV-A

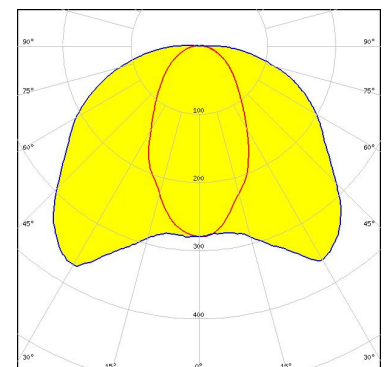

Light distribution files

### OPTICAL RESULTS (MEASURED):

**OSRAM**  
Opto Semiconductors

LED Soleriq S13 19x19  
 FWHM / FWTM Asymmetric  
 Efficiency 86 %  
 Peak intensity 0.4 cd/lm  
 LEDs/each optic 1  
 Light colour/type White  
 Required components:  
 TE Connectivity: 2213254-2 + OPTIC CLIP Z50 TYPE1 2213194-1

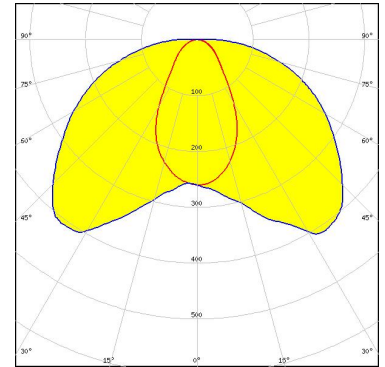

Light distribution files

**OSRAM**  
Opto Semiconductors

LED Soleriq S13 19x19  
 FWHM / FWTM Asymmetric  
 Efficiency 84 %  
 Peak intensity 0.4 cd/lm  
 LEDs/each optic 1  
 Light colour/type White  
 Required components:  
 IDEAL: 50-2103CT + 50-2100AN

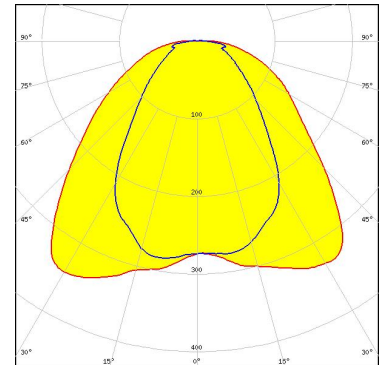

Light distribution files

**PHILIPS**

LED Fortimo SLM L13 + SLM holder  
 FWHM / FWTM Asymmetric  
 Efficiency 83 %  
 Peak intensity 0.4 cd/lm  
 LEDs/each optic 1  
 Light colour/type White  
 Required components:  
 TE Connectivity: OPTIC CLIP Z50 TYPE1 2213194-1

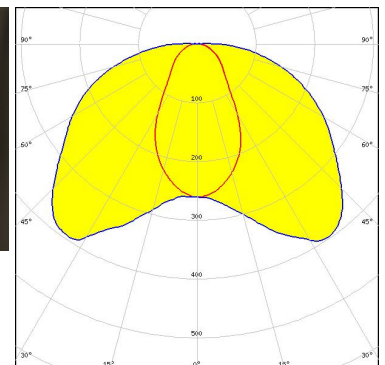
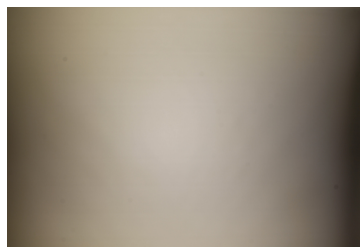

Light distribution files



### OPTICAL RESULTS (MEASURED):

#### PHILIPS

LED Fortimo SLM L13 CoB  
FWHM / FWTM Asymmetric  
Efficiency 83 %  
Peak intensity 0.4 cd/lm  
LEDs/each optic 1  
Light colour/type White  
Required components:  
TE Connectivity: 2213130-2 + OPTIC CLIP Z50 TYPE1 2213194-1

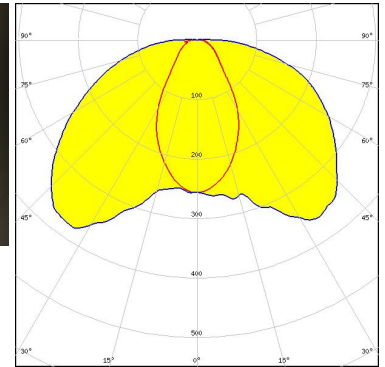
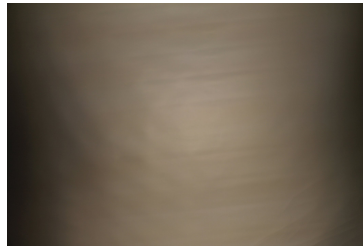

Light distribution files

#### PHILIPS

LED Fortimo SLM L15 + SLM holder  
FWHM / FWTM Asymmetric  
Efficiency 82 %  
Peak intensity 0.4 cd/lm  
LEDs/each optic 1  
Light colour/type White  
Required components:  
TE Connectivity: OPTIC CLIP Z50 TYPE1 2213194-1

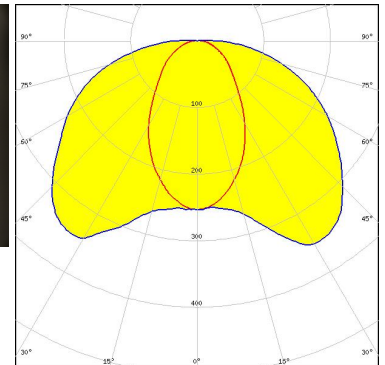
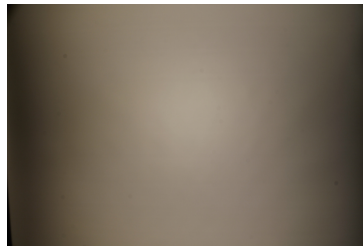

Light distribution files

#### SAMSUNG

LED LC040C  
FWHM / FWTM Asymmetric  
Efficiency 88 %  
Peak intensity 0.5 cd/lm  
LEDs/each optic 1  
Light colour/type White  
Required components:  
TE Connectivity: 2213382-2 + OPTIC CLIP Z50 TYPE1 2213194-1

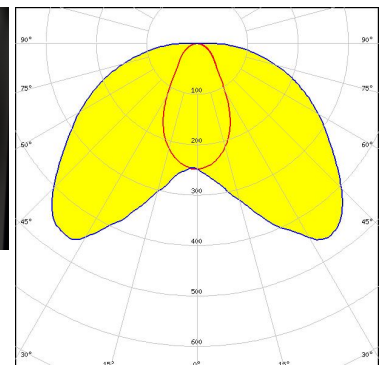
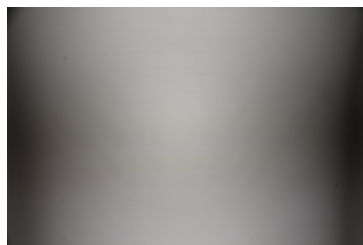

Light distribution files

### OPTICAL RESULTS (MEASURED):

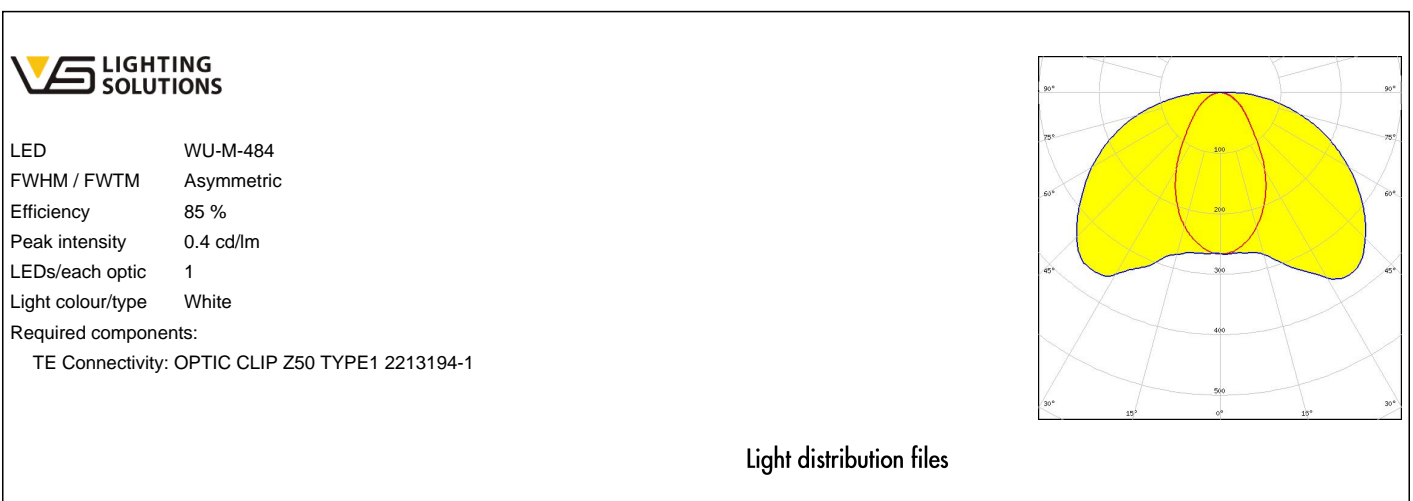
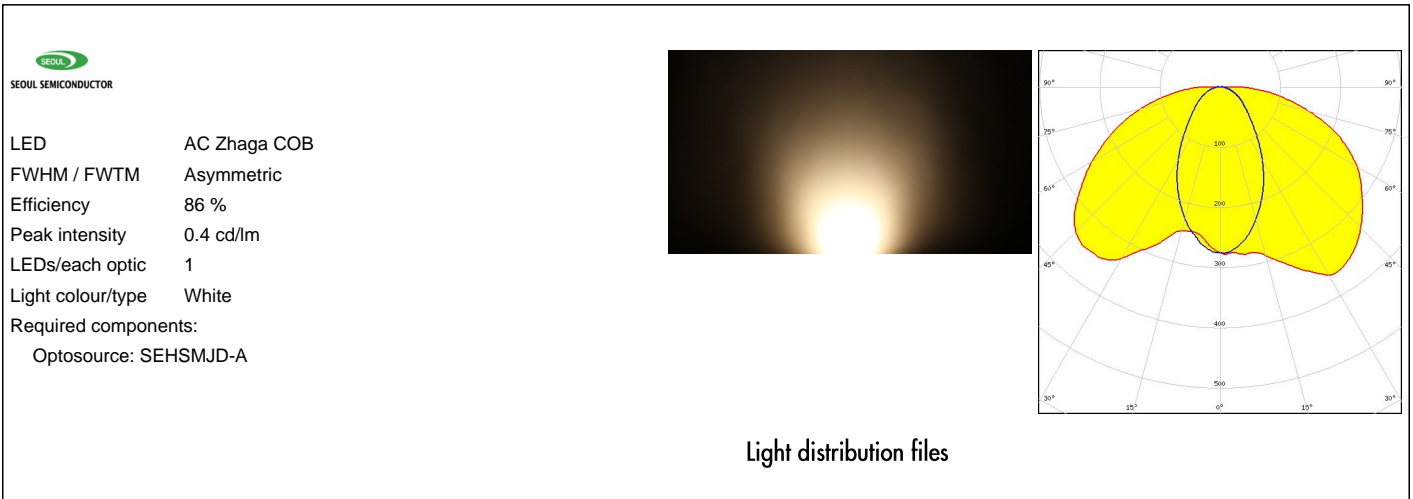



### OPTICAL RESULTS (SIMULATED):

bridgelux.

LED V10 Gen6  
FWHM / FWTM Asymmetric  
Efficiency 86 %  
LEDs/each optic 1  
Light colour/type White  
Required components:  
C13658\_CLAMP-VERO13-18

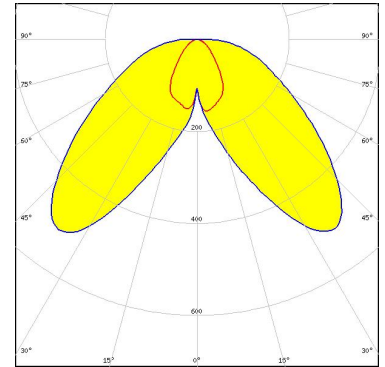

Bender Wirth: 455 Typ L1

Light distribution files

bridgelux.

LED V10 Gen6  
FWHM / FWTM Asymmetric  
Efficiency 86 %  
LEDs/each optic 1  
Light colour/type White  
Required components:  
C14123\_CLAMP-CXA15-18

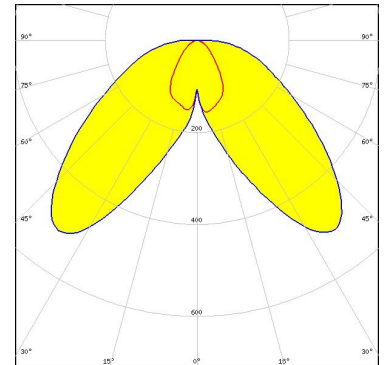

Light distribution files

bridgelux.

LED V13 Gen7  
FWHM / FWTM Asymmetric  
Efficiency 90 %  
LEDs/each optic 1  
Light colour/type White  
Required components:

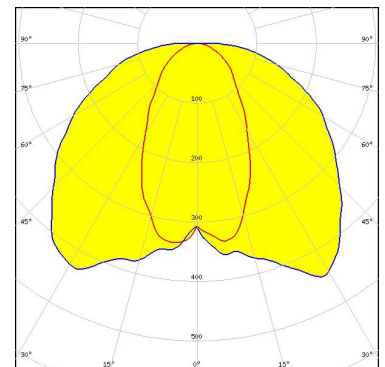

IDEAL: 50-2103CT + 50-2100AN

Light distribution files

### OPTICAL RESULTS (SIMULATED):



LED V13 Gen7  
FWHM / FWTM Asymmetric  
Efficiency 86 %  
Peak intensity 0.4 cd/lm  
LEDs/each optic 1  
Light colour/type White

Required components:

C13658\_CLAMP-VERO13-18

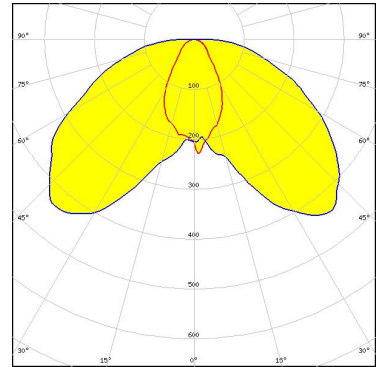

Bender Wirth: 477 Typ L1

Light distribution files

### CITIZEN

LED CLL02x/CLU02x (LES10)  
FWHM / FWTM Asymmetric  
Efficiency 86 %  
LEDs/each optic 1  
Light colour/type White

Required components:

C13658\_CLAMP-VERO13-18

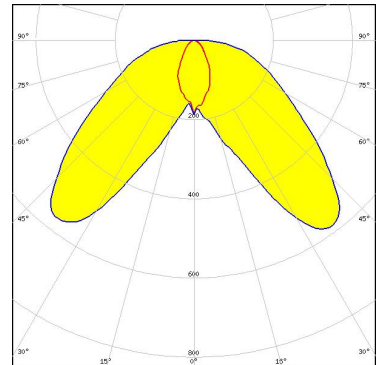

Bender Wirth: 434 Typ L1

Light distribution files

### CITIZEN

LED CLU700/701/702/703  
FWHM / FWTM Asymmetric  
Efficiency 87 %  
LEDs/each optic 1  
Light colour/type White

Required components:

C13658\_CLAMP-VERO13-18

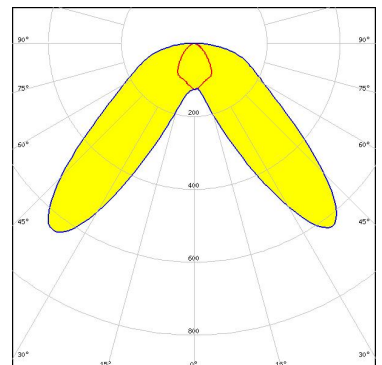

Bender Wirth: 434 Typ L1

Light distribution files

### OPTICAL RESULTS (SIMULATED):

#### CITIZEN

LED CLU710/711  
FWHM / FWTM Asymmetric  
Efficiency 87 %  
LEDs/each optic 1  
Light colour/type White  
Required components:  
C13658\_CLAMP-VERO13-18

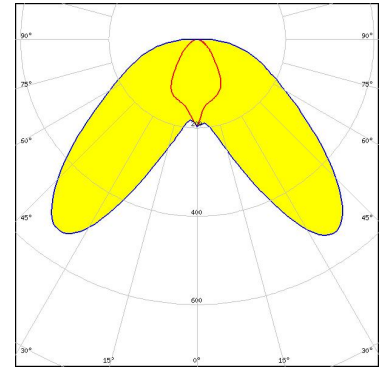

Bender Wirth: 470 Typ L1

Light distribution files



LED CXA/B 13xx  
FWHM / FWTM Asymmetric  
Efficiency 88 %  
LEDs/each optic 1  
Light colour/type White  
Required components:  
C13658\_CLAMP-VERO13-18

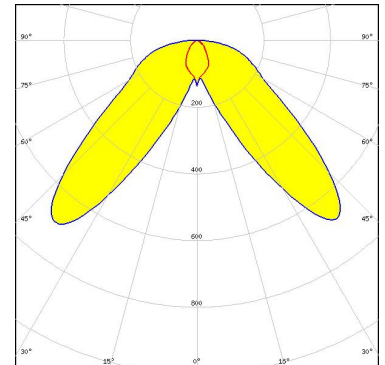

Bender Wirth: 448 Typ L1

Light distribution files



LED CXA/B 15xx  
FWHM / FWTM 42.0°  
Efficiency %  
LEDs/each optic 1  
Light colour/type White  
Required components:  
C14123\_CLAMP-CXA15-18

### OPTICAL RESULTS (SIMULATED):



LED CXA/B 15xx  
FWHM / FWTM Asymmetric  
Efficiency 87 %  
LEDs/each optic 1  
Light colour/type White  
Required components:  
C14123\_CLAMP-CXA15-18

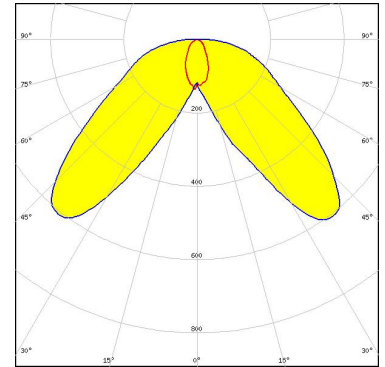

Light distribution files



LED CXA/B 1816 & CXA/B 1820 & CXA 1850  
FWHM / FWTM Asymmetric  
Efficiency %  
LEDs/each optic 1  
Light colour/type White  
Required components:

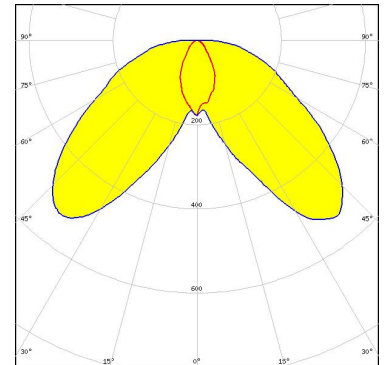

TE Connectivity: 2213401-2 + OPTIC CLIP Z50 TYPE1 2213194-1

Light distribution files



LED CXA/B 1816 & CXA/B 1820 & CXA 1850  
FWHM / FWTM Asymmetric  
Efficiency 87 %  
LEDs/each optic 1  
Light colour/type White  
Required components:  
C14123\_CLAMP-CXA15-18

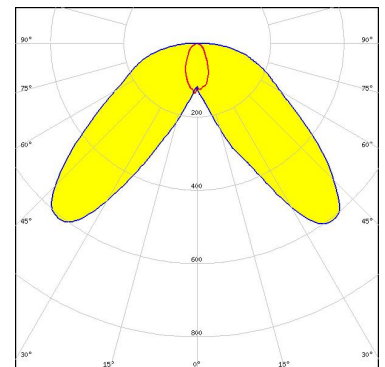

Light distribution files

### OPTICAL RESULTS (SIMULATED):



LED CXA/B 1830  
FWHM / FWTM Asymmetric  
Efficiency 85 %  
LEDs/each optic 1  
Light colour/type White  
Required components:  
C14123\_CLAMP-CXA15-18

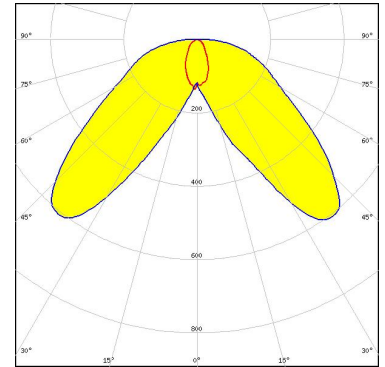

Light distribution files



LED LUXEON CoB 1202/1203  
FWHM / FWTM Asymmetric  
Efficiency 86 %  
LEDs/each optic 1  
Light colour/type White  
Required components:

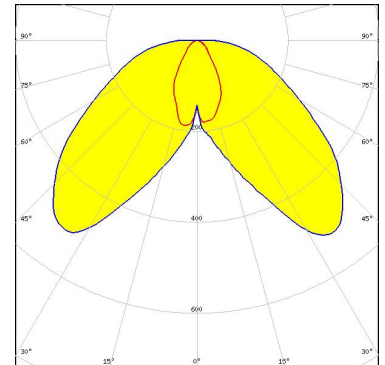

TE Connectivity: 2213382-2 + OPTIC CLIP Z50 TYPE1 2213194-1

Light distribution files



LED LUXEON CoB 1202s  
FWHM / FWTM Asymmetric  
Efficiency 87 %  
LEDs/each optic 1  
Light colour/type White  
Required components:  
C13658\_CLAMP-VERO13-18

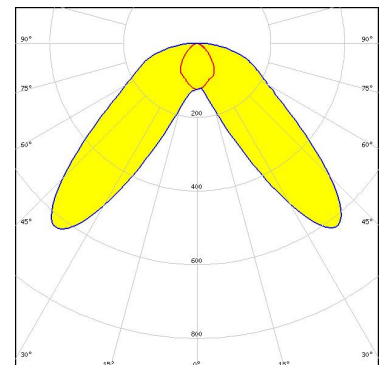

Bender Wirth: 452 Typ L1

Light distribution files

### OPTICAL RESULTS (SIMULATED):

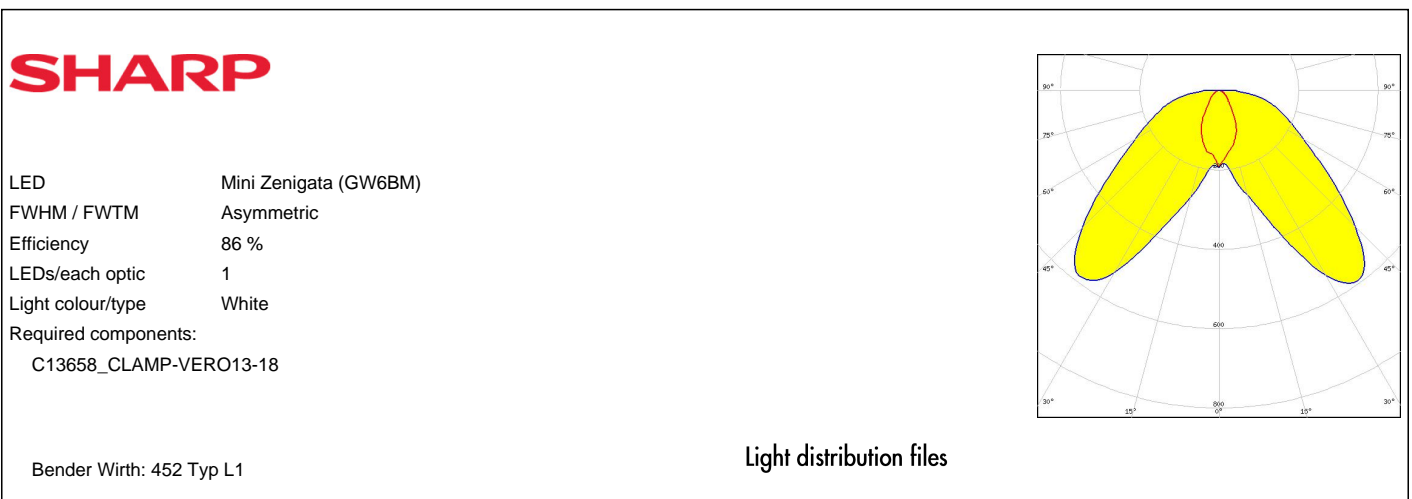
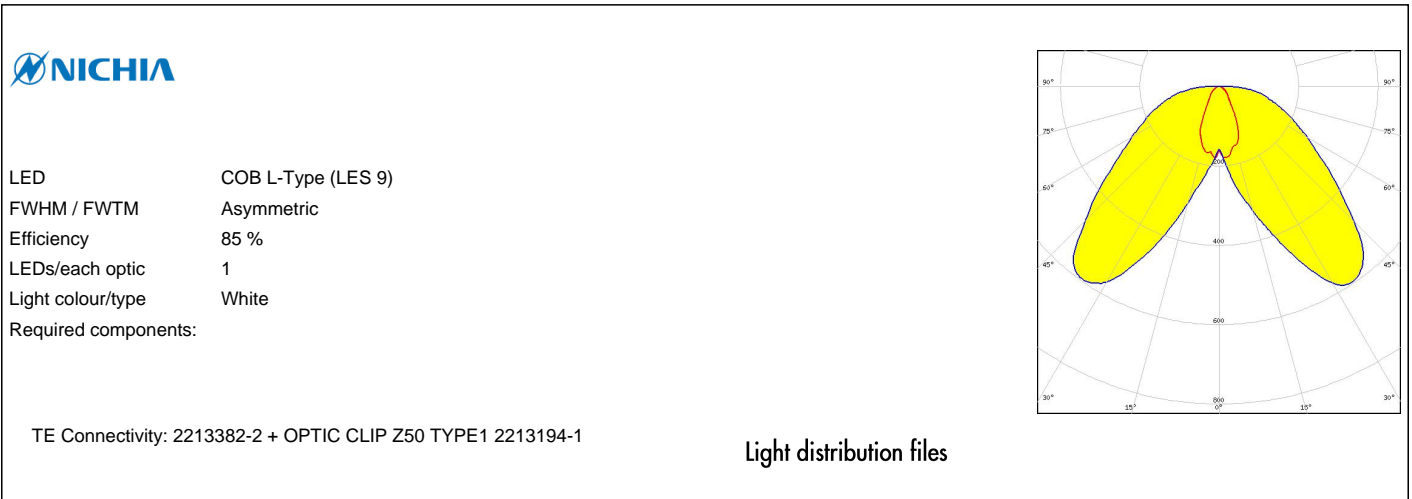

### GENERAL INFORMATION:

NOTE: The typical beam angle will be changed by different color, chip size and chip position tolerance. The typical total beam angle is the full angle measured where the luminous intensity is half of the peak value.

Due to use of high power COB's with this product, special attention to proper thermal design is highly recommended. LEDiL has no liability for direct, indirect or consecutive damages arising from the LEDiL products being used outside of the recommended temperature range.

### MATERIALS:

As part of our continuous research and improvement processes, and to ensure the best possible quality and availability of our products, LEDiL reserves the right to change material grades without notice.

### PRODUCT DATA USER AGREEMENT AND DISCLAIMER:

The measured data in the provided downloadable LEDiL Product Datasheets and Mechanical 2D-Drawings is rounded and provided as reference for planning. LEDiL Oy's optical specifications have been verified by conducting performance testing of the products in accordance with the company's quality system. The reported data are averaged results of multiple measurements with typical variation. LEDiL Oy reserves the right to without prior notification make changes and improvements to its products.

LEDiL Oy assumes neither warranty, nor guarantee nor any other liability of any kind for the contents and correctness of the provided data. The provided data has been generated with highest diligence but the provided data may in reality not represent the complete possible variation range of all intrinsic parameters. Therefore, in certain cases a deviation from the provided data could occur.

LEDiL Oy reserves the right to undertake technical changes of its products without further notification which could lead to changes in the provided data. LEDiL Oy assumes no liability of any kind for the possible deviation from any provided data or any other damage resulting from the usage of the provided data.

The user agrees to this disclaimer and user agreement with the download or usage of the provided files.

#### LEDiL Oy

Joensuunkatu 13  
FI-24240 SALO  
Finland

#### LEDiL Inc.

228 West Page Street  
Suite D  
Sycamore IL 60178  
USA

#### Ledil Optics Technology (Shenzhen) Co., Ltd.

# 405 , Block B  
Casic Motor Building  
Shenzhen 518057  
P.R.CHINA

#### Local sales and technical support

[www.ledil.com/  
where\\_to\\_buy](http://www.ledil.com/where_to_buy)

#### Shipping locations

Poznan, Poland  
Hong Kong, China

#### Distribution Partners

[www.ledil.com/  
where\\_to\\_buy](http://www.ledil.com/where_to_buy)