

### RONDA-S-C

~25° spot beam with holder C compatible with LEDiL HEKLA

#### SPECIFICATION:

Dimensions	Ø 52.1 mm
Height	17.2 mm
Fastening	socket
ROHS compliant	yes ⓘ



#### MATERIALS:

Component	Type	Material	Colour	Finish	Length (mm)
F15667_RONDA-S	Single lens	PMMA	clear		
F15635_RONDA-HLD-C	Holder	PC	white		

#### ORDERING INFORMATION:

##### Quantities for one set:

Single lens	1
Holder	1

Component		Qty in box	MOQ	MPQ	Box weight (kg)
F15667_RONDA-S	Single lens	420	120	30	6.3
» Box size: 480 x 280 x 300 mm					
F15635_RONDA-HLD-C	Holder	420	120	30	4.1
» Box size: 480 x 280 x 300 mm					

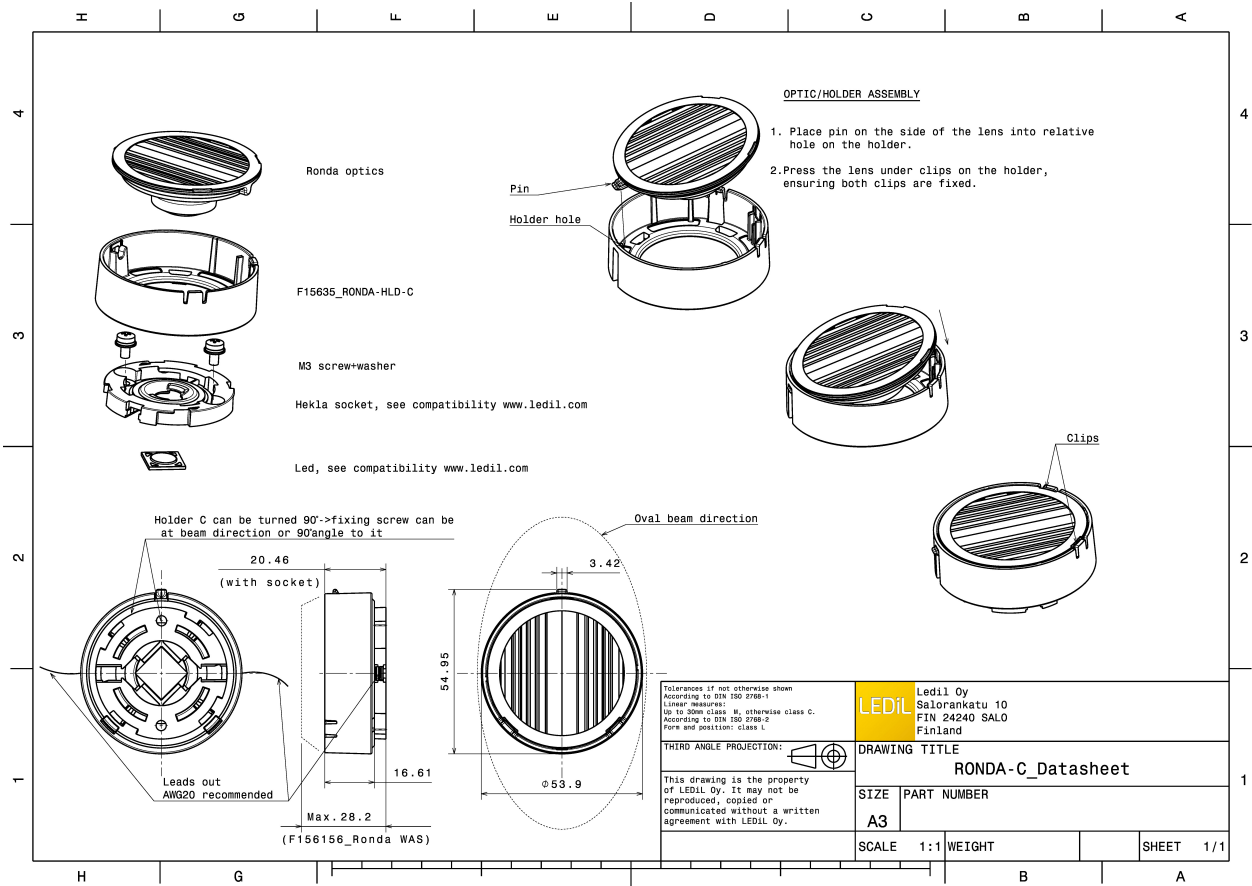

See also our general installation guide: [www.ledil.com/installation\\_guide](http://www.ledil.com/installation_guide)

### OPTICAL RESULTS (MEASURED):

bridgelux

LED V11 HD Gen 8  
 FWHM / FWTM 30.0° / 62.0°  
 Efficiency 84 %  
 Peak intensity 1.8 cd/lm  
 LEDs/each optic 1  
 Light colour/type White  
 Required components:  
 Bender Wirth: 633d Hekla

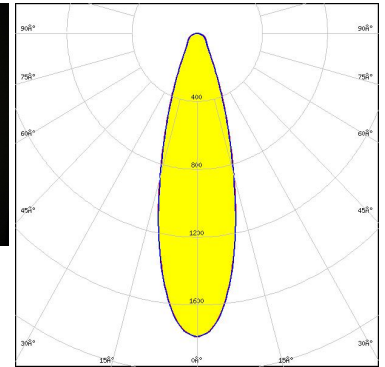
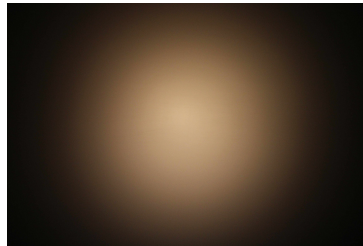

Light distribution files

bridgelux

LED V4 HD Gen 7  
 FWHM / FWTM 16.0° / 32.0°  
 Efficiency 90 %  
 Peak intensity 6.6 cd/lm  
 LEDs/each optic 1  
 Light colour/type White  
 Required components:  
 F15253\_HEKLA-SOCKET-A

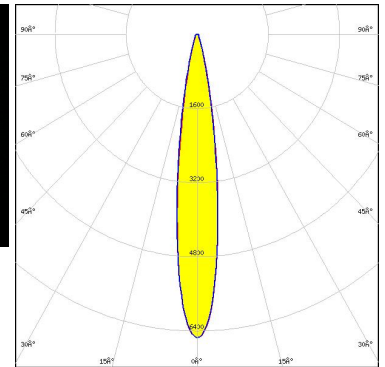
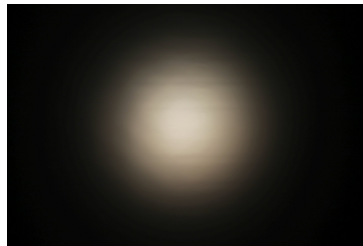

Light distribution files

bridgelux

LED V6 Gen6  
 FWHM / FWTM 18.0° / 38.0°  
 Efficiency 89 %  
 Peak intensity 4.5 cd/lm  
 LEDs/each optic 1  
 Light colour/type White  
 Required components:  
 F15253\_HEKLA-SOCKET-A

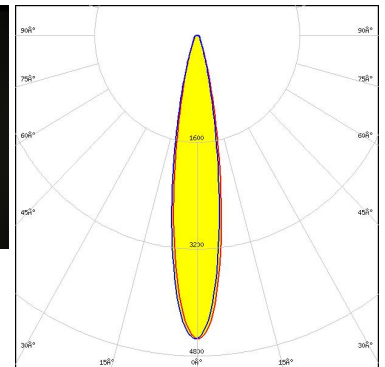
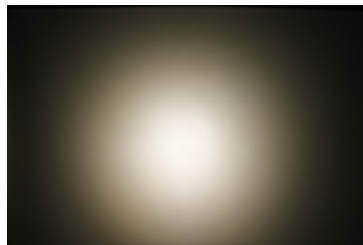

Light distribution files

### OPTICAL RESULTS (MEASURED):



**LED** V6 HD Gen 7  
**FWHM / FWTM** 20.0° / 39.0°  
**Efficiency** 89 %  
**Peak intensity** 4.3 cd/lm  
**LEDs/each optic** 1  
**Light colour/type** White  
**Required components:**  
 F15255\_HEKLA-SOCKET-C

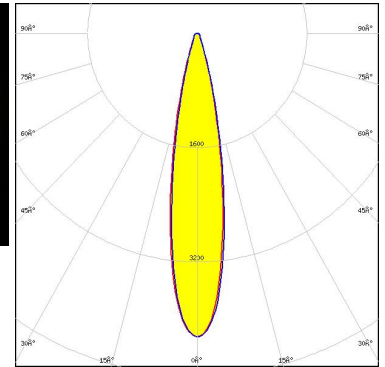
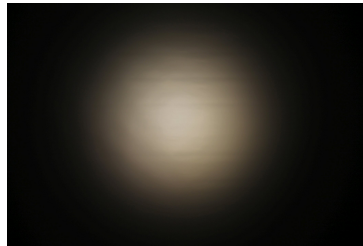

Light distribution files



**LED** V9 HD Gen7  
**FWHM / FWTM** 25.0° / 49.0°  
**Efficiency** 87 %  
**Peak intensity** 2.7 cd/lm  
**LEDs/each optic** 1  
**Light colour/type** White  
**Required components:**  
 F15859\_HEKLA-SOCKET-I

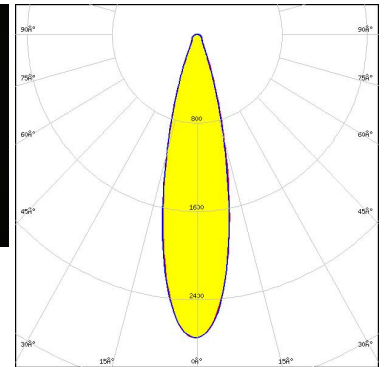
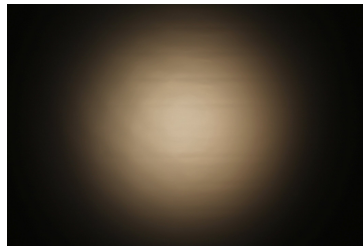

Light distribution files



**LED** VERO10  
**FWHM / FWTM** 25.0° / 53.0°  
**Efficiency** 87 %  
**Peak intensity** 2.5 cd/lm  
**LEDs/each optic** 1  
**Light colour/type** White  
**Required components:**  
 F15616\_HEKLA-SOCKET-F

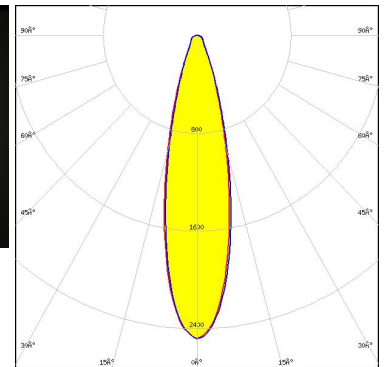
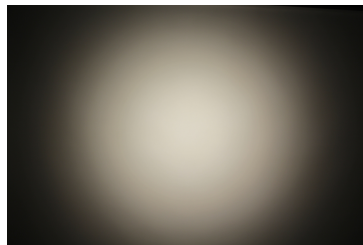

Light distribution files

### OPTICAL RESULTS (MEASURED):



**LED** Vesta TW 13mm (25W) CSP  
**FWHM / FWTM** 32.0° / 76.0°  
**Efficiency** 79 %  
**Peak intensity** 1.3 cd/lm  
**LEDs/each optic** 1  
**Light colour/type** White  
**Required components:**  
 C16142\_HEKLA-SOCKET-K  
 Bender Wirth: 492 Typ L8

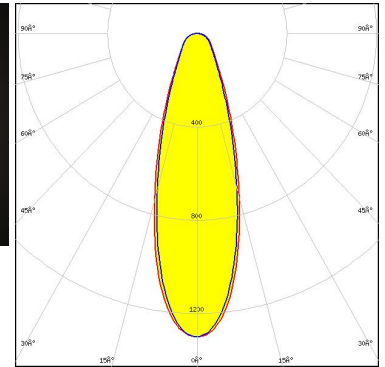
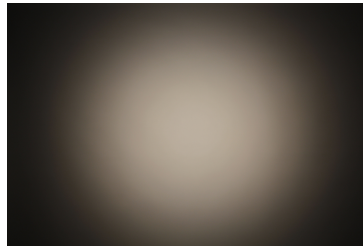

Light distribution files



**LED** Vesta TW 6mm DP  
**FWHM / FWTM** 20.0° / 41.0°  
**Efficiency** 83 %  
**Peak intensity** 3.7 cd/lm  
**LEDs/each optic** 1  
**Light colour/type** White  
**Required components:**  
 C16142\_HEKLA-SOCKET-K  
 Bender Wirth: 504 Typ L8

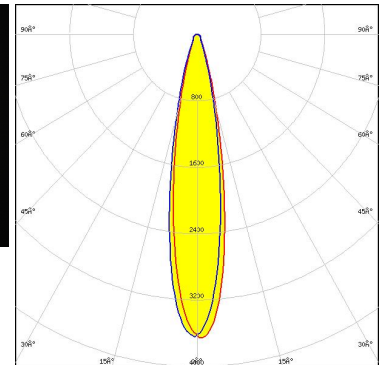
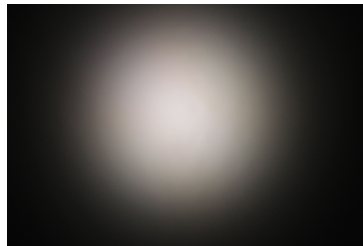

Light distribution files



**LED** Vesta TW 9mm (12W) CSP  
**FWHM / FWTM** 26.0° / 55.0°  
**Efficiency** 82 %  
**Peak intensity** 2.1 cd/lm  
**LEDs/each optic** 1  
**Light colour/type** White  
**Required components:**  
 C16142\_HEKLA-SOCKET-K  
 Bender Wirth: 489 Typ L8

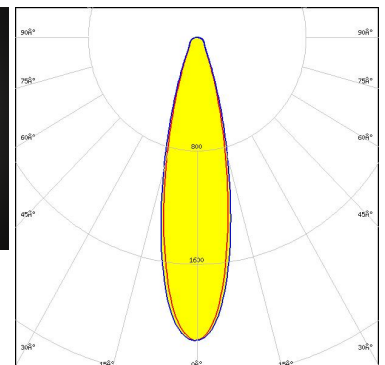
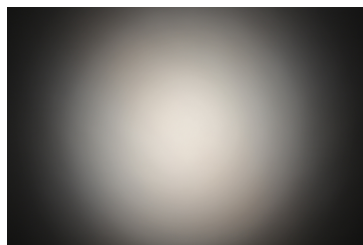

Light distribution files

### OPTICAL RESULTS (MEASURED):

#### CITIZEN

LED CLC020 Series (Dim-To-Warm)  
 FWHM / FWTM 28.0° / 58.0°  
 Efficiency 81 %  
 Peak intensity 1.9 cd/lm  
 LEDs/each optic 1  
 Light colour/type White  
 Required components:  
 C16142\_HEKLA-SOCKET-K

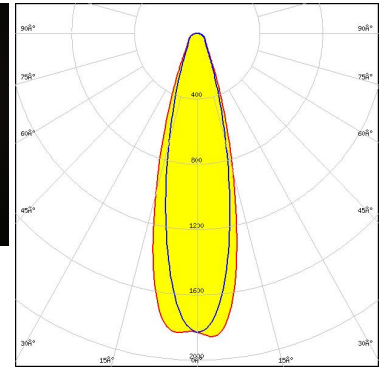
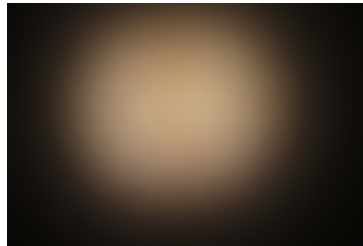

Light distribution files

#### CITIZEN

LED CLL02x/CLU02x (LES10)  
 FWHM / FWTM 26.0° / 54.0°  
 Efficiency 86 %  
 Peak intensity 2.3 cd/lm  
 LEDs/each optic 1  
 Light colour/type White  
 Required components:  
 F15255\_HEKLA-SOCKET-C

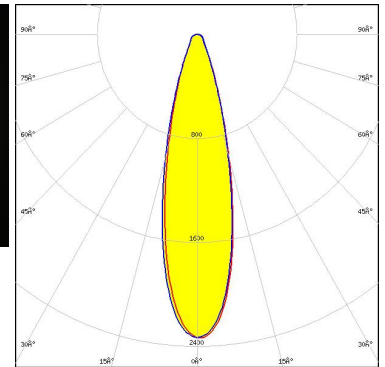
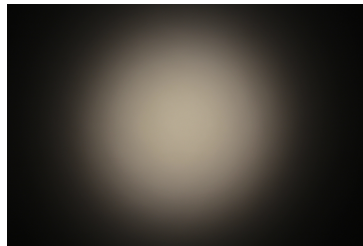

Light distribution files

#### CITIZEN

LED CLU700/701/702/703  
 FWHM / FWTM 19.0° / 39.0°  
 Efficiency 87 %  
 Peak intensity 4.1 cd/lm  
 LEDs/each optic 1  
 Light colour/type White  
 Required components:  
 F15255\_HEKLA-SOCKET-C

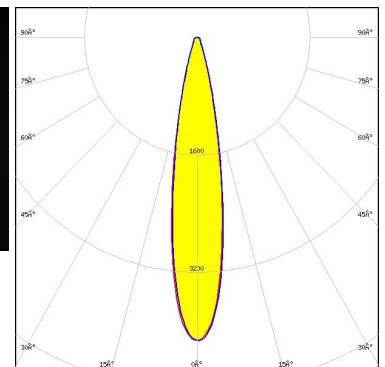
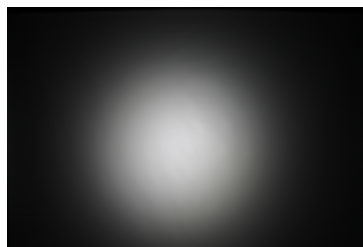

Light distribution files

### OPTICAL RESULTS (MEASURED):

#### CITIZEN

LED CLU7A2/7A3  
 FWHM / FWTM 15.0° / 31.0°  
 Efficiency 89 %  
 Peak intensity 6.6 cd/lm  
 LEDs/each optic 1  
 Light colour/type White  
 Required components:  
 F15255\_HEKLA-SOCKET-C

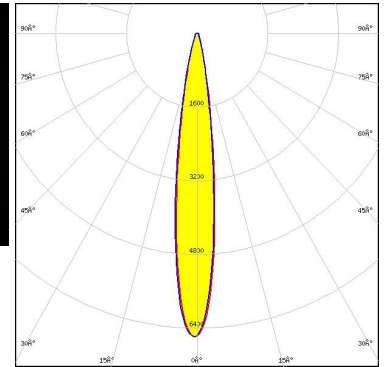

Light distribution files



LED CMA1516  
 FWHM / FWTM 27.0° / 52.0°  
 Efficiency 89 %  
 Peak intensity 2.5 cd/lm  
 LEDs/each optic 1  
 Light colour/type White  
 Required components:  
 F15256\_HEKLA-SOCKET-D

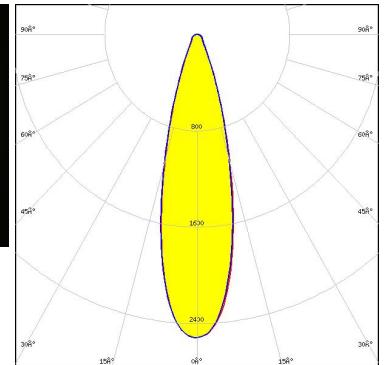
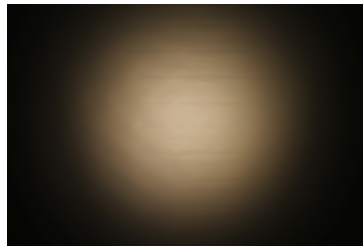

Light distribution files



LED CMA1825  
 FWHM / FWTM 33.0° / 68.0°  
 Efficiency 87 %  
 Peak intensity 1.6 cd/lm  
 LEDs/each optic 1  
 Light colour/type White  
 Required components:  
 F15254\_HEKLA-SOCKET-B

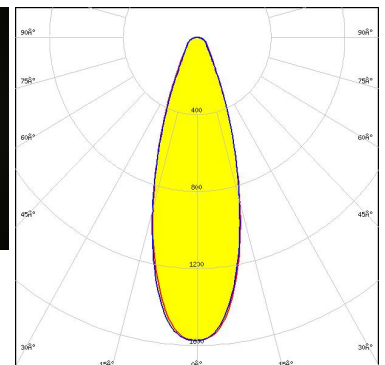
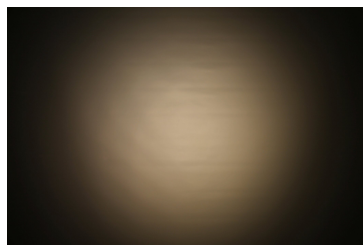

Light distribution files



### OPTICAL RESULTS (MEASURED):



**LED** CMT14xx  
**FWHM / FWTM** 28.0° / 55.0°  
**Efficiency** 88 %  
**Peak intensity** 2.3 cd/lm  
**LEDs/each optic** 1  
**Light colour/type** White  
**Required components:**  
 F15255\_HEKLA-SOCKET-C

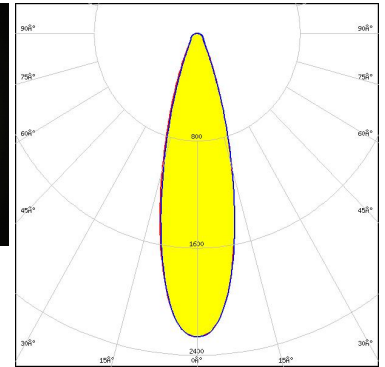
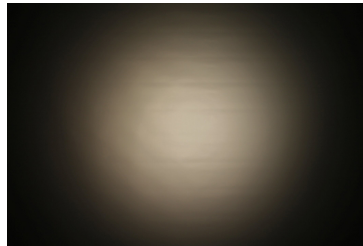

Light distribution files



**LED** CMT19xx  
**FWHM / FWTM** 35.0° / 82.0°  
**Efficiency** 82 %  
**Peak intensity** 1.2 cd/lm  
**LEDs/each optic** 1  
**Light colour/type** White  
**Required components:**  
 F15859\_HEKLA-SOCKET-I

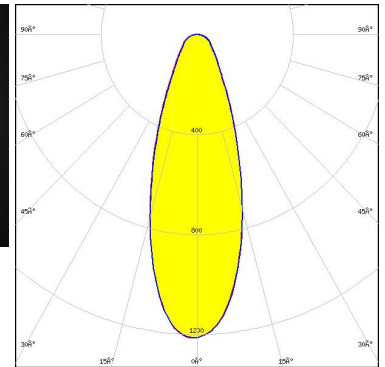
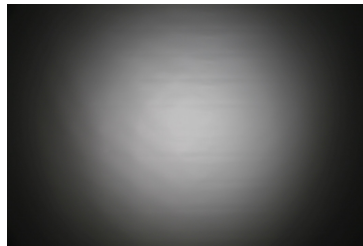

Light distribution files



**LED** CXA/B 13xx  
**FWHM / FWTM** 19.0° / 39.0°  
**Efficiency** 88 %  
**Peak intensity** 4.4 cd/lm  
**LEDs/each optic** 1  
**Light colour/type** White  
**Required components:**  
 F15956\_HEKLA-SOCKET-J

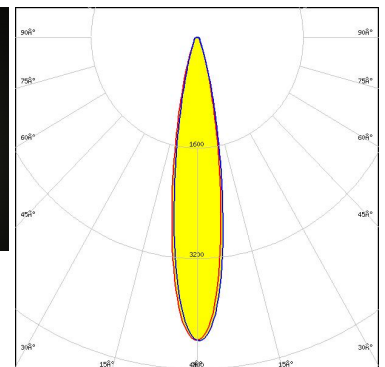
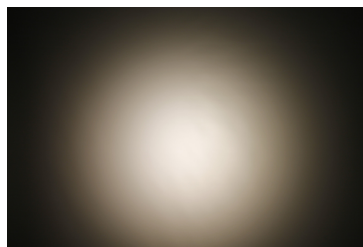

Light distribution files

### OPTICAL RESULTS (MEASURED):



LED CXA/B 15xx  
 FWHM / FWTM 25.0° / 50.0°  
 Efficiency 88 %  
 Peak intensity 2.7 cd/lm  
 LEDs/each optic 1  
 Light colour/type White  
 Required components:  
 F15256\_HEKLA-SOCKET-D

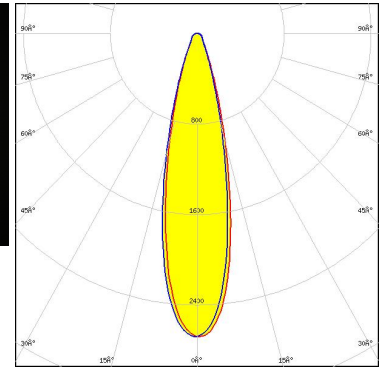
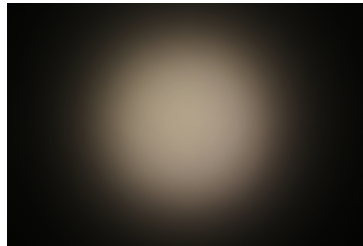

Light distribution files



LED LUXEON CX Plus CoB L08 (Gen2)  
 FWHM / FWTM 36.0° / 82.0°  
 Efficiency 84 %  
 Peak intensity 1.2 cd/lm  
 LEDs/each optic 1  
 Light colour/type White  
 Required components:  
 Bender Wirth: 637a Hekla

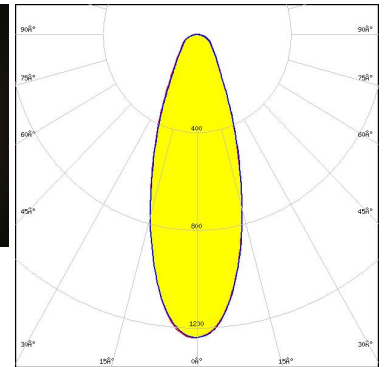
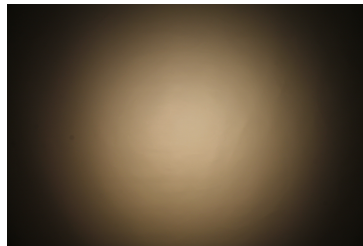

Light distribution files



LED LUXEON CoB 1202HD  
 FWHM / FWTM 21.0° / 40.0°  
 Efficiency 89 %  
 Peak intensity 4.1 cd/lm  
 LEDs/each optic 1  
 Light colour/type White  
 Required components:  
 F15848\_HEKLA-SOCKET-G

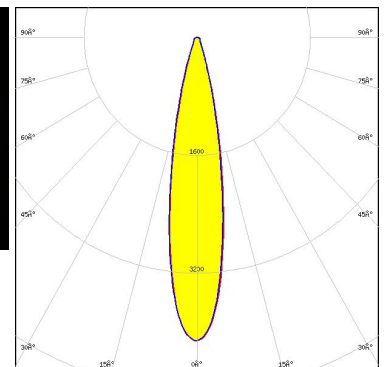
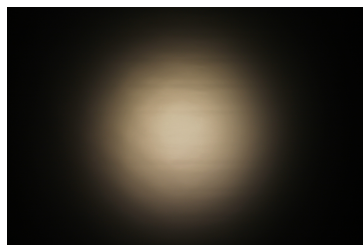

Light distribution files

### OPTICAL RESULTS (MEASURED):



LED LUXEON CoB 1202s  
 FWHM / FWTM 19.0° / 39.0°  
 Efficiency 89 %  
 Peak intensity 4.4 cd/lm  
 LEDs/each optic 1  
 Light colour/type White  
 Required components:  
 F15848\_HEKLA-SOCKET-G

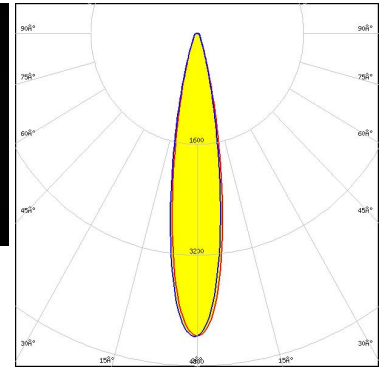
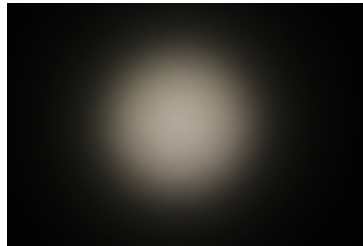

Light distribution files



LED LUXEON CoB 1204HD  
 FWHM / FWTM 27.0° / 51.0°  
 Efficiency 88 %  
 Peak intensity 2.5 cd/lm  
 LEDs/each optic 1  
 Light colour/type White  
 Required components:  
 F15858\_HEKLA-SOCKET-H

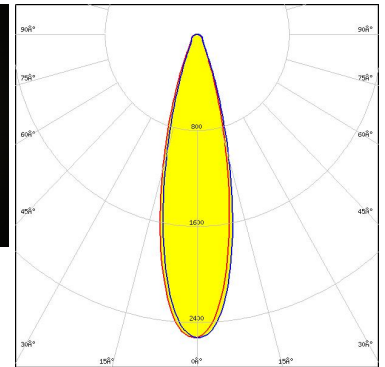
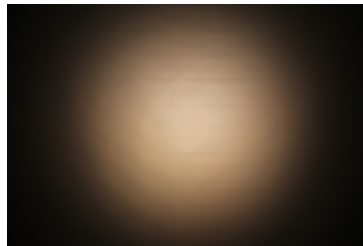

Light distribution files



LED LUXEON CoB 1205HD  
 FWHM / FWTM 31.0° / 61.0°  
 Efficiency 86 %  
 Peak intensity 1.8 cd/lm  
 LEDs/each optic 1  
 Light colour/type White  
 Required components:  
 F15858\_HEKLA-SOCKET-H

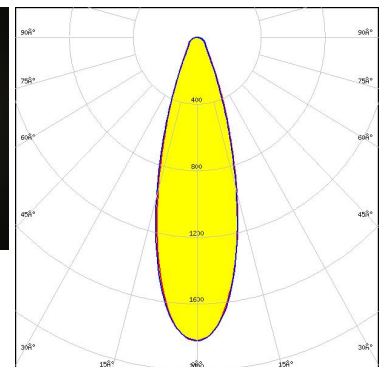
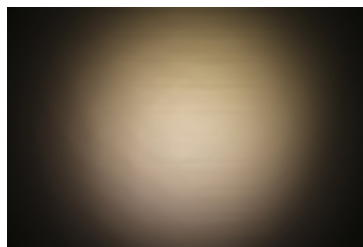

Light distribution files

### OPTICAL RESULTS (MEASURED):



**LED** LUXEON CX Plus CoB - HD S01H4  
**FWHM / FWTM** 18.0° / 37.0°  
**Efficiency** 89 %  
**Peak intensity** 5 cd/lm  
**LEDs/each optic** 1  
**Light colour/type** White  
**Required components:**  
 Bender Wirth: 634c Hekla

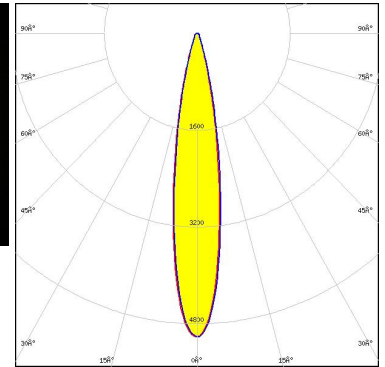

Light distribution files



**LED** LUXEON CX Plus CoB - HD S02H6  
**FWHM / FWTM** 19.0° / 39.0°  
**Efficiency** 90 %  
**Peak intensity** 4.4 cd/lm  
**LEDs/each optic** 1  
**Light colour/type** White  
**Required components:**  
 Bender Wirth: 634c Hekla

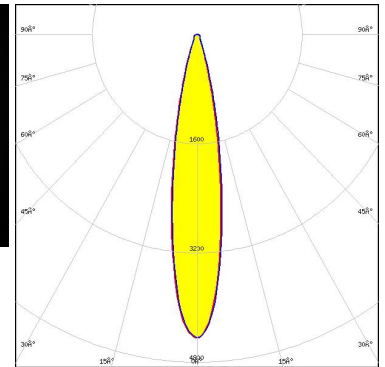
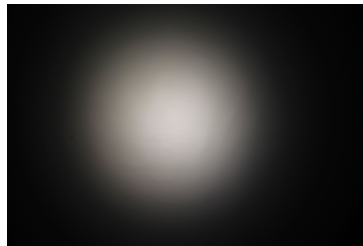

Light distribution files



**LED** LUXEON CX Plus CoB - HD S04H9  
**FWHM / FWTM** 26.0° / 51.0°  
**Efficiency** 88 %  
**Peak intensity** 2.6 cd/lm  
**LEDs/each optic** 1  
**Light colour/type** White  
**Required components:**  
 Bender Wirth: 634c Hekla

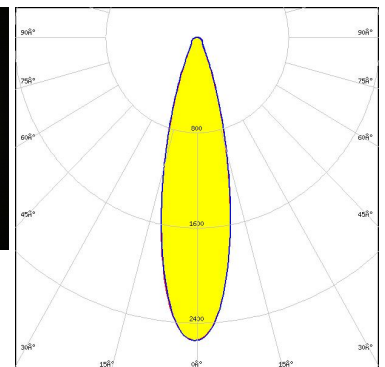
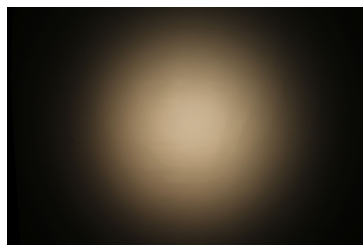

Light distribution files

### OPTICAL RESULTS (MEASURED):



LED LUXEON CX Plus CoB L04 / L05 (Gen2)  
 FWHM / FWTM 31.0° / 63.0°  
 Efficiency 87 %  
 Peak intensity 1.8 cd/lm  
 LEDs/each optic 1  
 Light colour/type White  
 Required components:  
 Bender Wirth: 637a Hekla

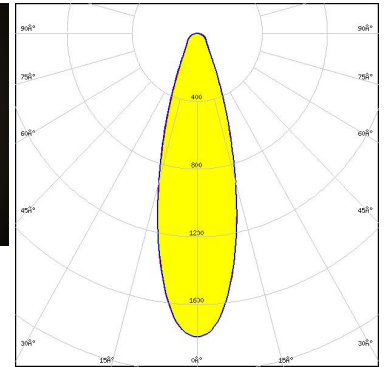
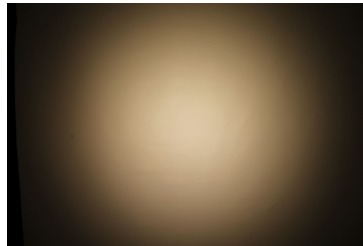

Light distribution files



LED LUXEON CX Plus CoB M02 / M03 (Gen2)  
 FWHM / FWTM 24.0° / 48.0°  
 Efficiency 88 %  
 Peak intensity 2.9 cd/lm  
 LEDs/each optic 1  
 Light colour/type White  
 Required components:  
 Bender Wirth: 641a Hekla

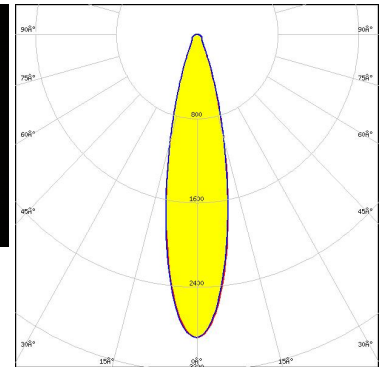
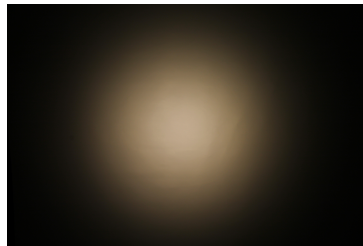

Light distribution files



LED LUXEON CX Plus CoB S01 (Gen2)  
 FWHM / FWTM 18.0° / 36.0°  
 Efficiency 90 %  
 Peak intensity 5.1 cd/lm  
 LEDs/each optic 1  
 Light colour/type White  
 Required components:  
 Bender Wirth: 634c Hekla

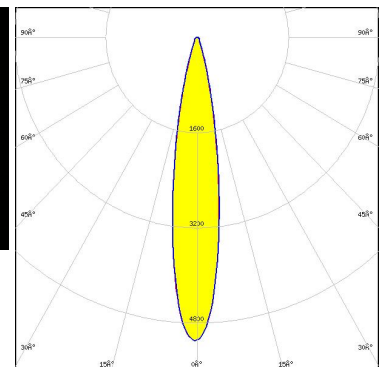
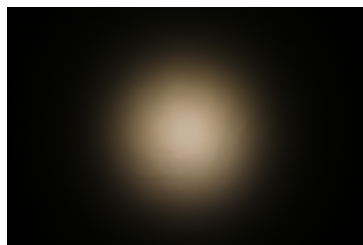

Light distribution files

### OPTICAL RESULTS (MEASURED):



LED CDM-9 (Dim-To-Warm)  
 FWHM / FWTM 26.0° / 52.0°  
 Efficiency 82 %  
 Peak intensity 2.3 cd/lm  
 LEDs/each optic 1  
 Light colour/type White  
 Required components:  
 C16142\_HEKLA-SOCKET-K  
 Bender Wirth: 490 Typ L8

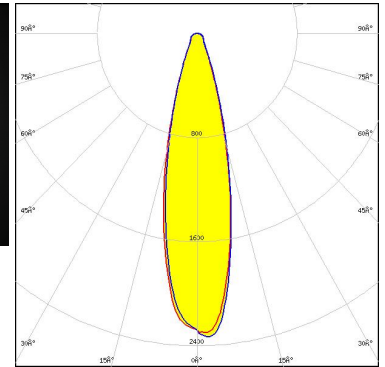
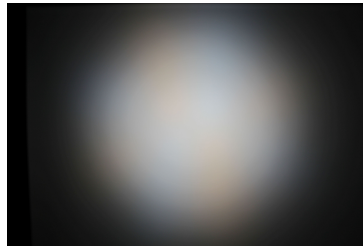

Light distribution files



LED CXM-4  
 FWHM / FWTM 16.0° / 33.0°  
 Efficiency 88 %  
 Peak intensity 5.6 cd/lm  
 LEDs/each optic 1  
 Light colour/type White  
 Required components:  
 F15255\_HEKLA-SOCKET-C

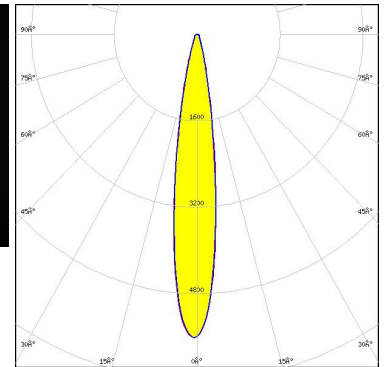

Light distribution files



LED CxM-9 (13.5x13.5)  
 FWHM / FWTM 27.0° / 55.0°  
 Efficiency 86 %  
 Peak intensity 2.3 cd/lm  
 LEDs/each optic 1  
 Light colour/type White  
 Required components:  
 F15255\_HEKLA-SOCKET-C

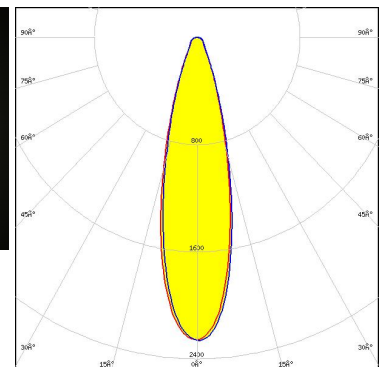
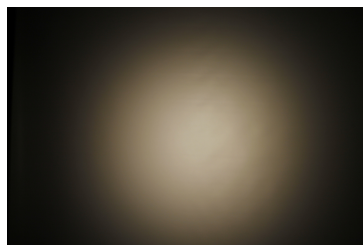

Light distribution files

### OPTICAL RESULTS (MEASURED):

#### PHILIPS

LED Fortimo SLM L09 CoB  
FWHM / FWTM 26.0° / 51.0°  
Efficiency 87 %  
Peak intensity 2.5 cd/lm  
LEDs/each optic 1  
Light colour/type White  
Required components:  
F15858\_HEKLA-SOCKET-H

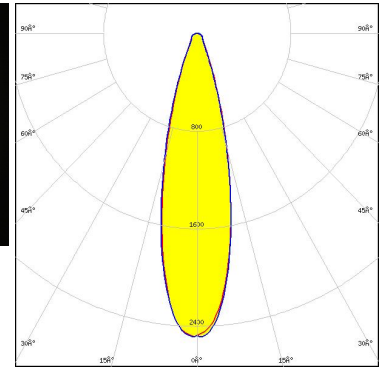
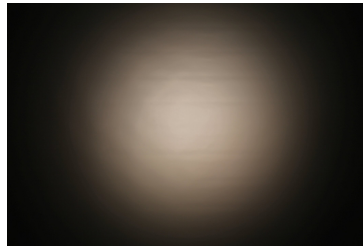

Light distribution files

#### PHILIPS

LED Fortimo SLM L13 CoB  
FWHM / FWTM 33.0° / 77.0°  
Efficiency 80 %  
Peak intensity 1.3 cd/lm  
LEDs/each optic 1  
Light colour/type White  
Required components:  
C16140\_CLAMP-VERO29  
Bender Wirth: 432 Typ L8

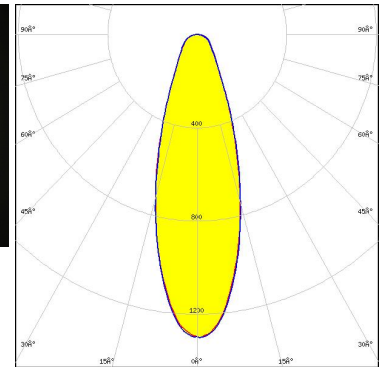
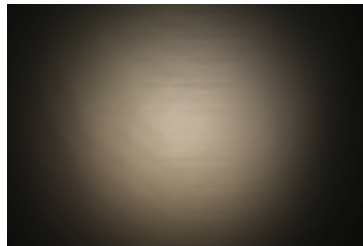

Light distribution files

#### PHILIPS

LED Fortimo SLM L13 CoB  
FWHM / FWTM 33.0° / 77.0°  
Efficiency 80 %  
Peak intensity 1.3 cd/lm  
LEDs/each optic 1  
Light colour/type White  
Required components:  
C16142\_HEKLA-SOCKET-K  
Bender Wirth: 432 Typ L8

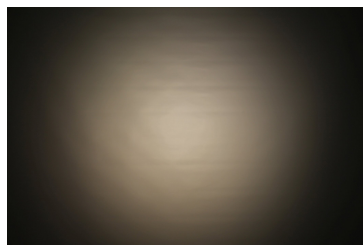

Light distribution files

### OPTICAL RESULTS (MEASURED):

#### SAMSUNG

LED LC003D / LC006D / LC009D / LC013D  
FWHM / FWTM 27.0° / 55.0°  
Efficiency 87 %  
Peak intensity 2.3 cd/lm  
LEDs/each optic 1  
Light colour/type White  
Required components:  
F15255\_HEKLA-SOCKET-C

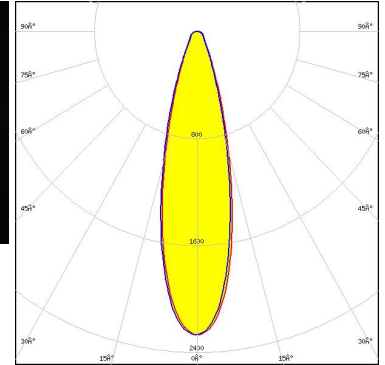

Light distribution files

#### SAMSUNG

LED LC010C  
FWHM / FWTM 20.0° / 41.0°  
Efficiency 88 %  
Peak intensity 3.8 cd/lm  
LEDs/each optic 1  
Light colour/type White  
Required components:  
F15848\_HEKLA-SOCKET-G

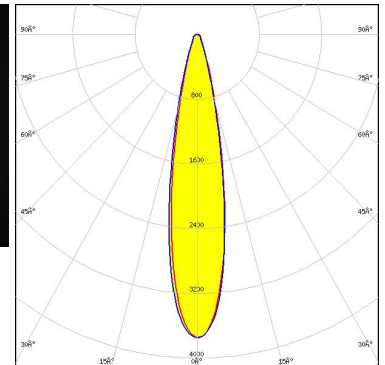
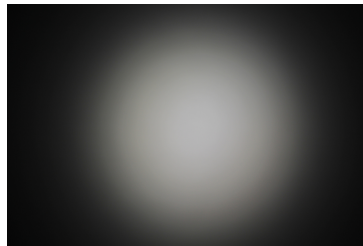

Light distribution files

#### SAMSUNG

LED LC010C G2  
FWHM / FWTM 19.0° / 38.0°  
Efficiency 87 %  
Peak intensity 4.3 cd/lm  
LEDs/each optic 1  
Light colour/type White  
Required components:  
F15255\_HEKLA-SOCKET-C

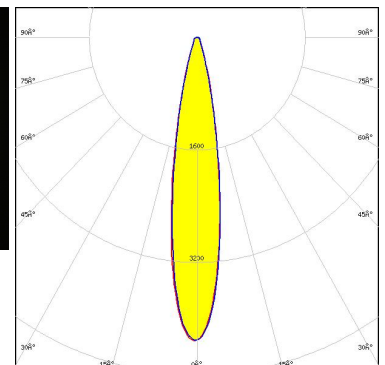
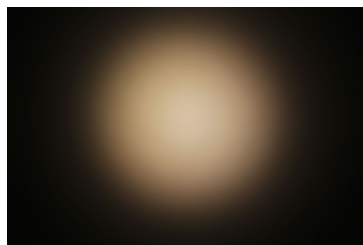

Light distribution files



### OPTICAL RESULTS (MEASURED):

#### SAMSUNG

LED LC010T (Tunable White)  
 FWHM / FWTM 26.0° / 56.0°  
 Efficiency 82 %  
 Peak intensity 2.1 cd/lm  
 LEDs/each optic 1  
 Light colour/type Tunable White  
 Required components:  
 C16142\_HEKLA-SOCKET-K  
 Bender Wirth: 501 Typ L8

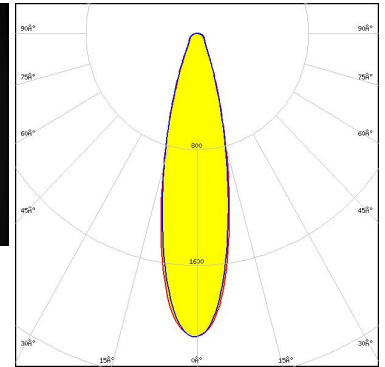
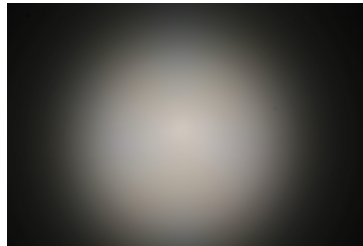

Light distribution files

#### SAMSUNG

LED LC016D / LC019D / LC026D / LC033D  
 FWHM / FWTM 34.0° / 85.0°  
 Efficiency 79 %  
 Peak intensity 1.1 cd/lm  
 LEDs/each optic 1  
 Light colour/type White  
 Required components:  
 F15859\_HEKLA-SOCKET-I

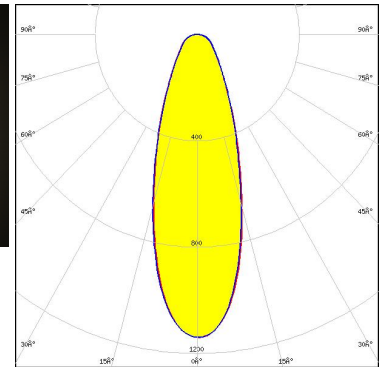
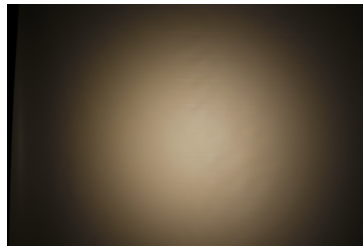

Light distribution files

#### SAMSUNG

LED LC020C  
 FWHM / FWTM 24.0° / 48.0°  
 Efficiency 88 %  
 Peak intensity 2.9 cd/lm  
 LEDs/each optic 1  
 Light colour/type White  
 Required components:  
 F15848\_HEKLA-SOCKET-G

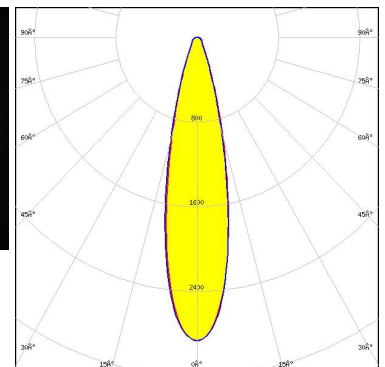
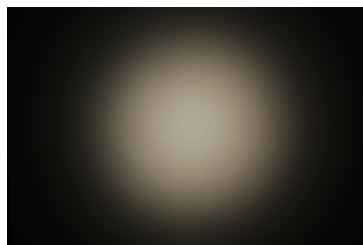

Light distribution files

### OPTICAL RESULTS (MEASURED):

#### SAMSUNG

LED LC020C G2  
 FWHM / FWTM 25.0° / 51.0°  
 Efficiency 85 %  
 Peak intensity 2.5 cd/lm  
 LEDs/each optic 1  
 Light colour/type White  
 Required components:  
 F15859\_HEKLA-SOCKET-I

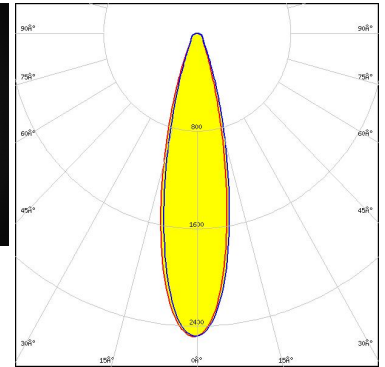
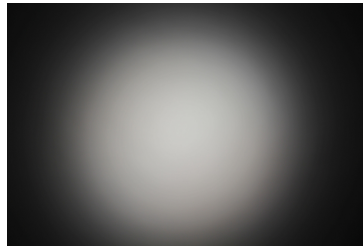

Light distribution files

#### SAMSUNG

LED LC020T (Tunable white)  
 FWHM / FWTM 33.0° / 76.0°  
 Efficiency 79 %  
 Peak intensity 1.3 cd/lm  
 LEDs/each optic 1  
 Light colour/type Tunable White  
 Required components:  
 C16142\_HEKLA-SOCKET-K  
 Bender Wirth: 501 Typ L8

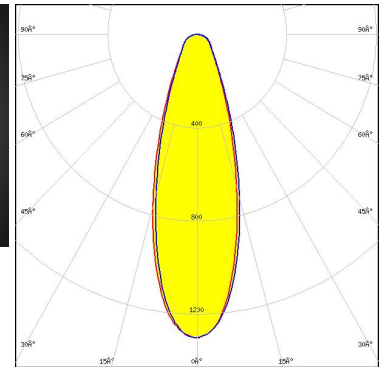
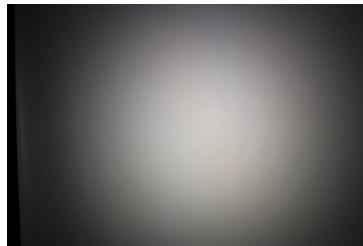

Light distribution files



LED MJT COB LES 6  
 FWHM / FWTM 19.0° / 39.0°  
 Efficiency 85 %  
 Peak intensity 4.1 cd/lm  
 LEDs/each optic 1  
 Light colour/type White  
 Required components:  
 F15255\_HEKLA-SOCKET-C

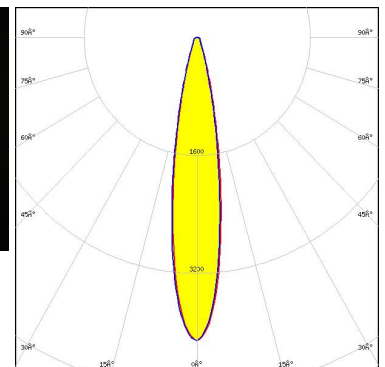
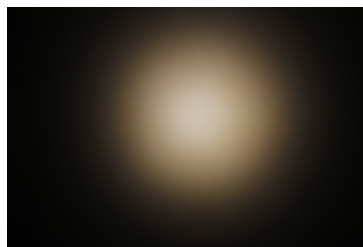

Light distribution files

### OPTICAL RESULTS (MEASURED):

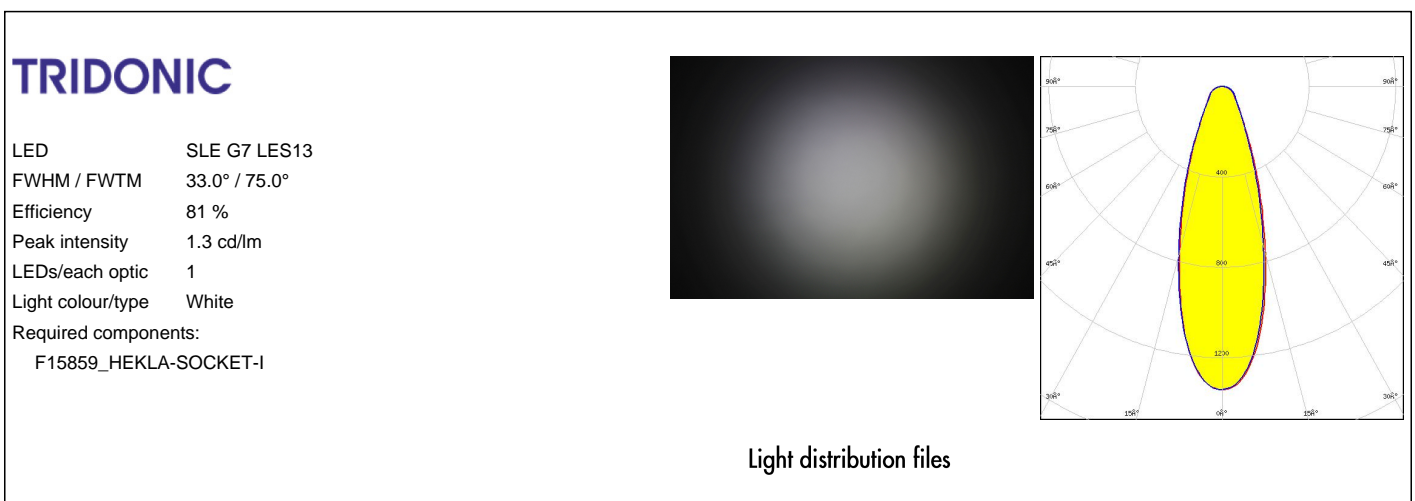
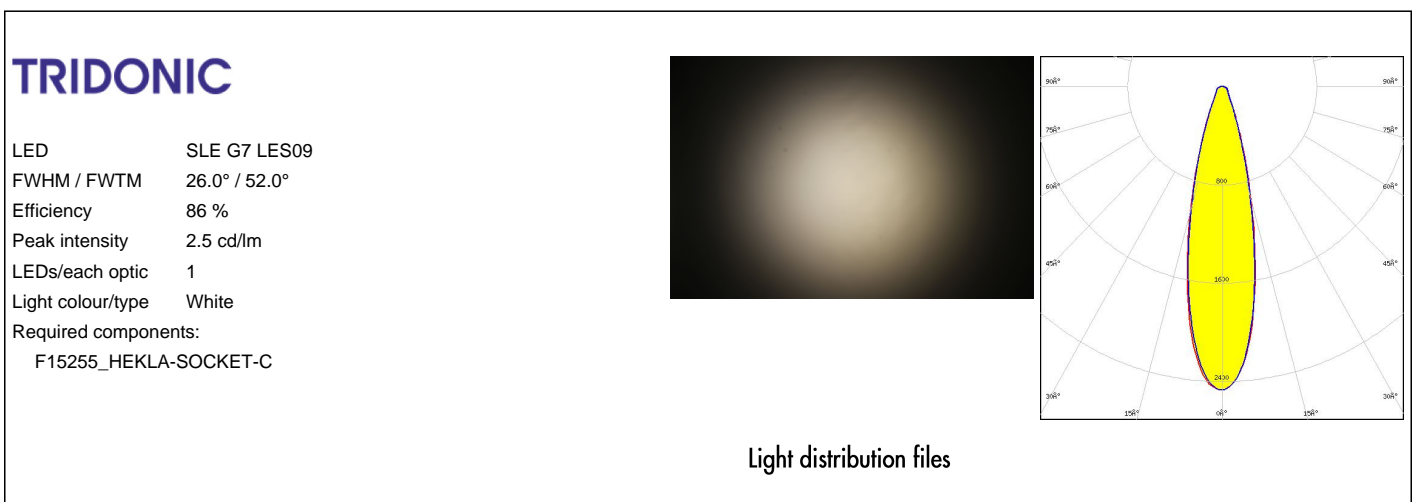
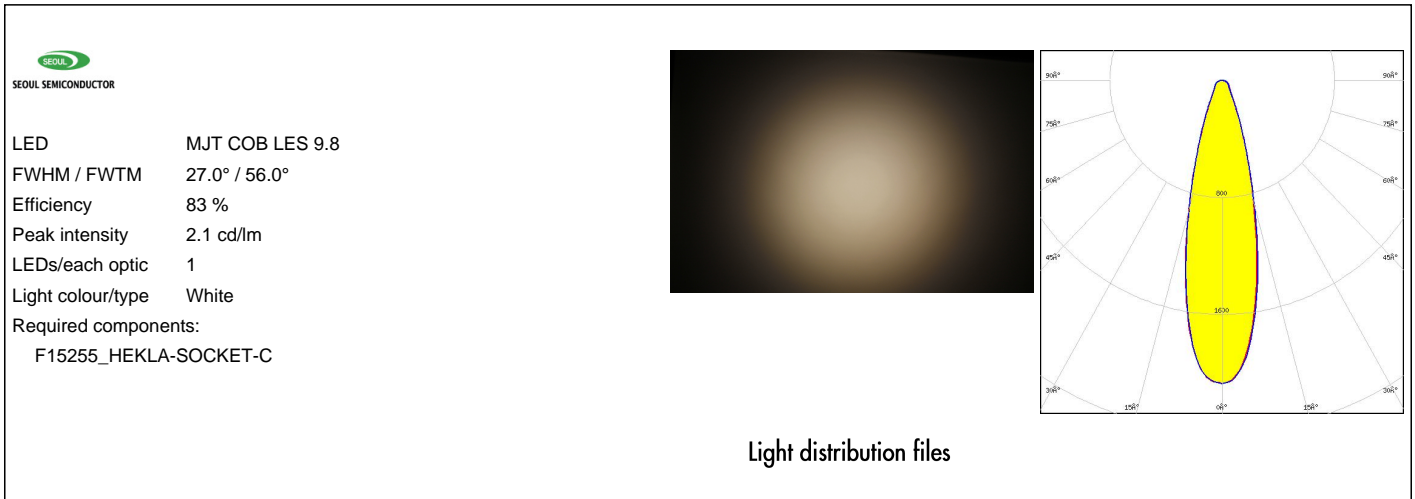

### OPTICAL RESULTS (MEASURED):

#### TRIDONIC

LED SLE G7 LES15  
FWHM / FWTM 34.0° / 84.0°  
Efficiency 80 %  
Peak intensity 1.2 cd/lm  
LEDs/each optic 1  
Light colour/type White  
Required components:  
F15859\_HEKLA-SOCKET-I

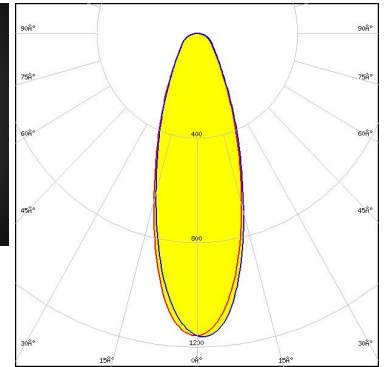
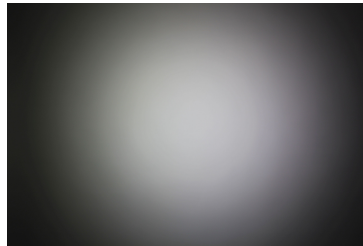

Light distribution files

#### XICATO

LED XOB 14.5 mm  
FWHM / FWTM 34.0° / 80.0°  
Efficiency 80 %  
Peak intensity 1.2 cd/lm  
LEDs/each optic 1  
Light colour/type White  
Required components:  
F15859\_HEKLA-SOCKET-I

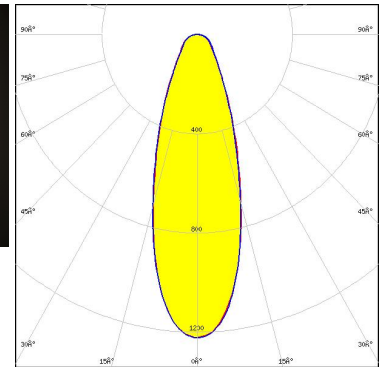
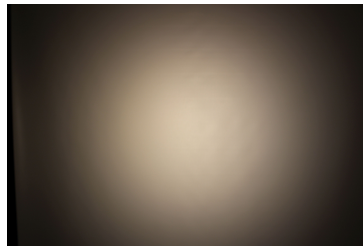

Light distribution files

#### XICATO

LED XOB 9.8 mm  
FWHM / FWTM 25.0° / 53.0°  
Efficiency 87 %  
Peak intensity 2.5 cd/lm  
LEDs/each optic 1  
Light colour/type White  
Required components:  
F15255\_HEKLA-SOCKET-C

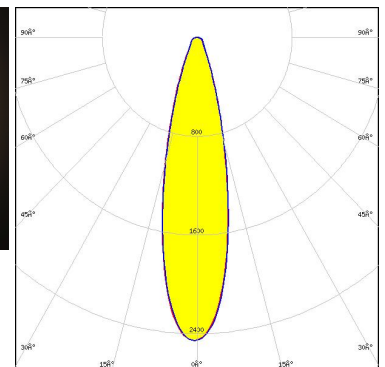
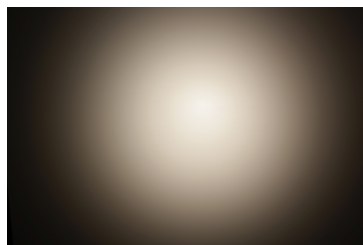

Light distribution files

### OPTICAL RESULTS (MEASURED):

#### XICATO

LED XTM - 19mm LES  
FWHM / FWTM 36.0° / 108.0°  
Efficiency 80 %  
Peak intensity 0.9 cd/lm  
LEDs/each optic 1  
Light colour/type White  
Required components:  
C16058\_XTM-ADAPTER-50-C

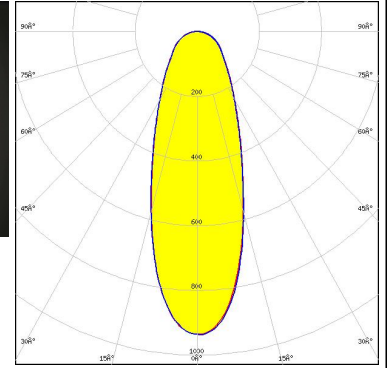
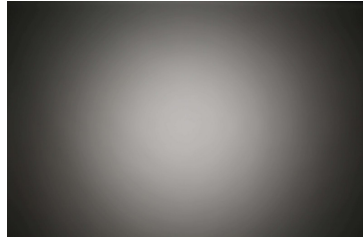

Light distribution files

### OPTICAL RESULTS (SIMULATED):



**LED**                      Vero SE 13  
**FWHM / FWTM**        24.0° / 67.0°  
**Efficiency**             69 %  
**Peak intensity**        1.7 cd/lm  
**LEDs/each optic**      1  
**Light colour/type**     White  
**Required components:**  
     C16142\_HEKLA-SOCKET-K

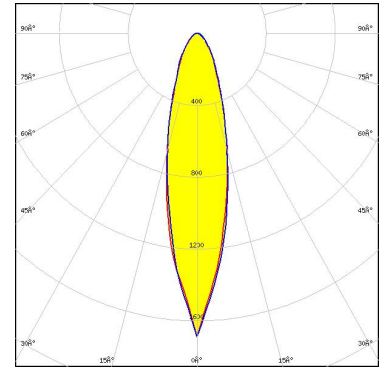

Light distribution files

### CITIZEN

**LED**                      CLL03x/CLU03x  
**FWHM / FWTM**        28.0° / 68.0°  
**Efficiency**             82 %  
**Peak intensity**        1.8 cd/lm  
**LEDs/each optic**      1  
**Light colour/type**     White  
**Required components:**  
     F15859\_HEKLA-SOCKET-I

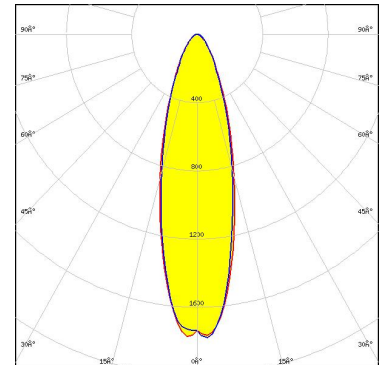

Light distribution files



**LED**                      CMA1840  
**FWHM / FWTM**        30.0° / 68.0°  
**Efficiency**             80 %  
**Peak intensity**        1.7 cd/lm  
**LEDs/each optic**      1  
**Light colour/type**     White  
**Required components:**

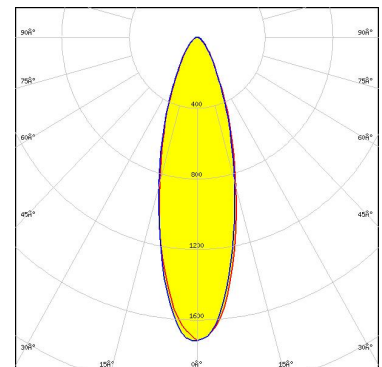

Bender Wirth: 637a Hekla

Light distribution files

### OPTICAL RESULTS (SIMULATED):



LED CMT14xx  
FWHM / FWTM 16.0° / 50.0°  
Efficiency 83 %  
Peak intensity 3.4 cd/lm  
LEDs/each optic 1  
Light colour/type White  
Required components:  
F15255\_HEKLA-SOCKET-C

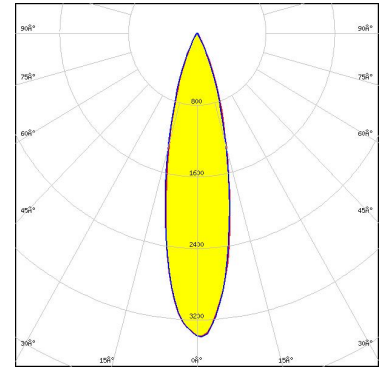

Light distribution files



LED CMU15xx  
FWHM / FWTM 29.0° / 69.0°  
Efficiency 79 %  
Peak intensity 1.7 cd/lm  
LEDs/each optic 1  
Light colour/type White  
Required components:  
F17438\_HEKLA-G2-I

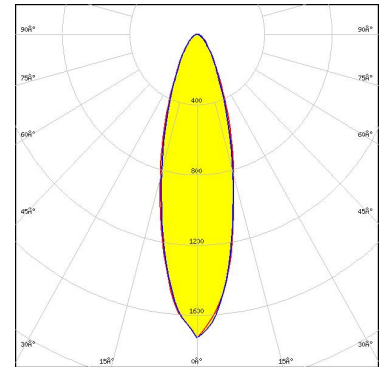

Light distribution files



LED LUXEON CoB 1202/1203  
FWHM / FWTM 26.0° / 58.0°  
Efficiency 70 %  
Peak intensity 2 cd/lm  
LEDs/each optic 1  
Light colour/type White  
Required components:  
F17437\_HEKLA-G2-H

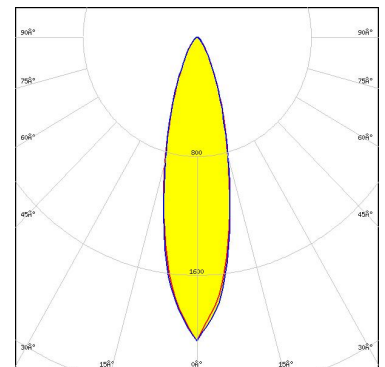

Light distribution files

### OPTICAL RESULTS (SIMULATED):



LED COB T-Type  
FWHM / FWTM 19.0° / 38.0°  
Efficiency 85 %  
Peak intensity 5.7 cd/lm  
LEDs/each optic 1  
Light colour/type White

Required components:

F15848\_HEKLA-SOCKET-G

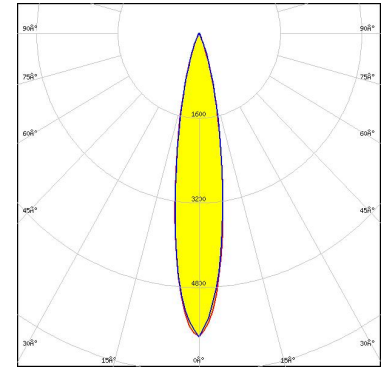

Light distribution files



### GENERAL INFORMATION:

NOTE: The typical beam angle will be changed by different color, chip size and chip position tolerance. The typical total beam angle is the full angle measured where the luminous intensity is half of the peak value.

Due to use of high power COB's with this product, special attention to proper thermal design is highly recommended. LEDiL has no liability for direct, indirect or consecutive damages arising from the LEDiL products being used outside of the recommended temperature range.

### MATERIALS:

As part of our continuous research and improvement processes, and to ensure the best possible quality and availability of our products, LEDiL reserves the right to change material grades without notice.

### PRODUCT DATA USER AGREEMENT AND DISCLAIMER:

The measured data in the provided downloadable LEDiL Product Datasheets and Mechanical 2D-Drawings is rounded and provided as reference for planning. LEDiL Oy's optical specifications have been verified by conducting performance testing of the products in accordance with the company's quality system. The reported data are averaged results of multiple measurements with typical variation. LEDiL Oy reserves the right to without prior notification make changes and improvements to its products.

LEDiL Oy assumes neither warranty, nor guarantee nor any other liability of any kind for the contents and correctness of the provided data. The provided data has been generated with highest diligence but the provided data may in reality not represent the complete possible variation range of all intrinsic parameters. Therefore, in certain cases a deviation from the provided data could occur.

LEDiL Oy reserves the right to undertake technical changes of its products without further notification which could lead to changes in the provided data. LEDiL Oy assumes no liability of any kind for the possible deviation from any provided data or any other damage resulting from the usage of the provided data.

The user agrees to this disclaimer and user agreement with the download or usage of the provided files.

#### LEDiL Oy

Joensuunkatu 13  
FI-24240 SALO  
Finland

#### LEDiL Inc.

228 West Page Street  
Suite D  
Sycamore IL 60178  
USA

#### Ledil Optics Technology (Shenzhen) Co., Ltd.

# 405 , Block B  
Casic Motor Building  
Shenzhen 518057  
P.R.CHINA

#### Local sales and technical support

[www.ledil.com/  
where\\_to\\_buy](http://www.ledil.com/where_to_buy)

#### Shipping locations

Poznan, Poland  
Hong Kong, China

#### Distribution Partners

[www.ledil.com/  
where\\_to\\_buy](http://www.ledil.com/where_to_buy)