

STRADA-SQ-ME

Beam with excellent longitudinal luminance uniformity fulfilling EN13201 M-class requirements where road width is equal to or less than the pole height. Version with location pins and installation tap

SPECIFICATION:

Dimensions	25.0 x 25.0 mm
Height	8.8 mm
Fastening	tape, pin, screw
ROHS compliant	yes ⓘ





MATERIALS:

Component	Type	Material	Colour	Finish	Length (mm)
STRADA-SQ-ME	Single lens	PMMA	clear		
ROSE-TAPE	Tape	Acrylic foam	black		

ORDERING INFORMATION:

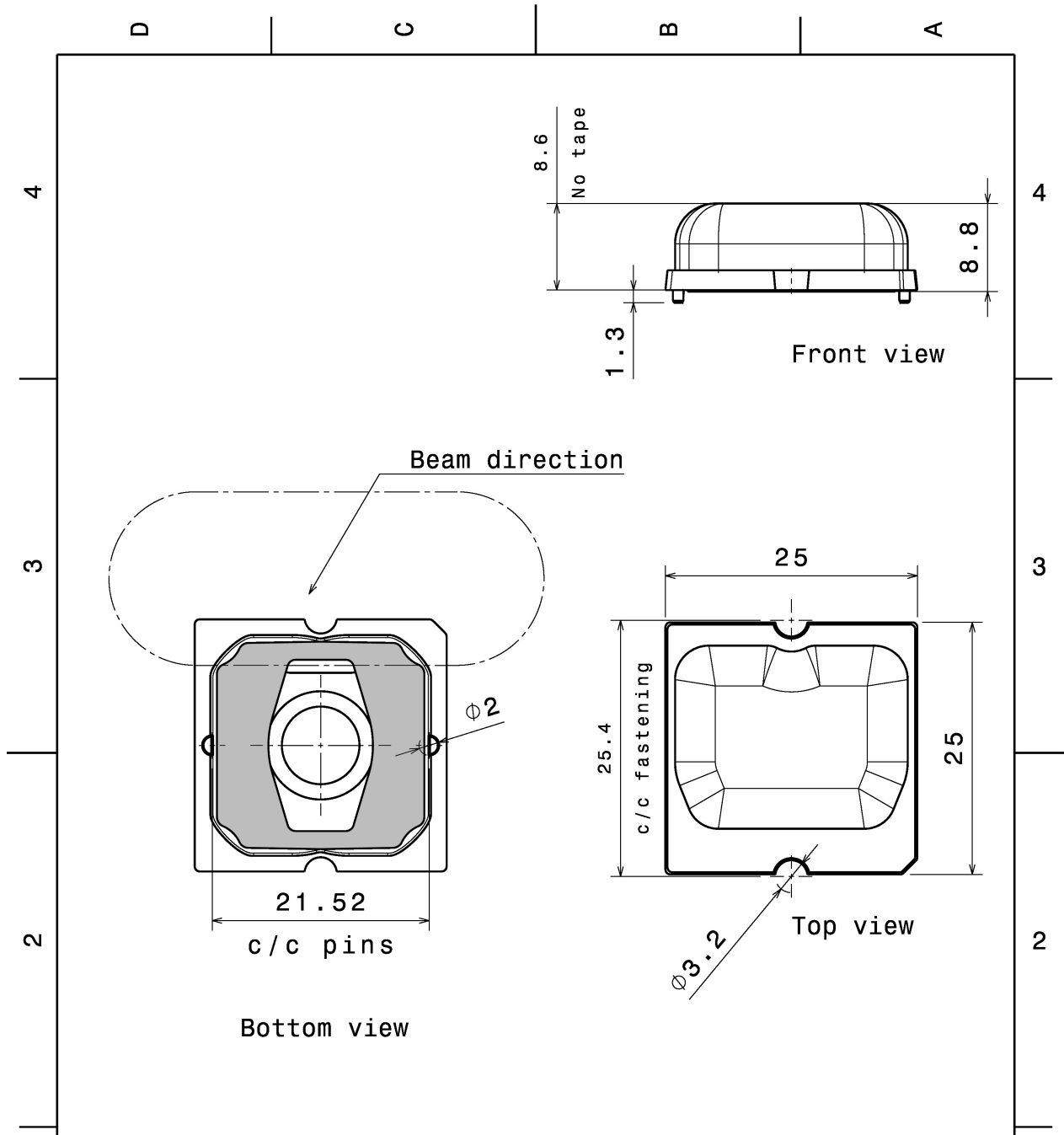
Component		Qty in box	MOQ	MPQ	Box weight (kg)
CA14026_STRADA-SQ-ME	Single lens	2058	294	98	8.8
» Box size: 480 x 280 x 300 mm					

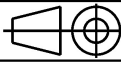

<p>Tolerances if not otherwise shown According to DIN ISO 2768-1 Linear measures: Up to 30mm class M, otherwise class C. According to DIN ISO 2768-2 Form and position: class L</p>			<p>Ledil Oy Salorankatu 10 FIN 24240 SALO Finland</p>		
	<p>THIRD ANGLE PROJECTION: </p>		<p>DRAWING TITLE STRADA-SQ-ME_Mechanicaldrawing</p>		
	<p>This drawing is the property of LEDiL Oy. It may not be reproduced, copied or communicated without a written agreement with LEDiL Oy."</p>		<p>SIZE A4</p>	<p>PART NUMBER -</p>	
<p>SCALE 2:1</p>		<p>WEIGHT -</p>		<p>SHEET 1/1</p>	

See also our general installation guide: www.ledil.com/installation_guide

OPTICAL RESULTS (MEASURED):



LED MK-R
FWHM / FWTM Asymmetric
Efficiency 93 %
Peak intensity 0.6 cd/lm
LEDs/each optic 1
Light colour/type White
Required components:

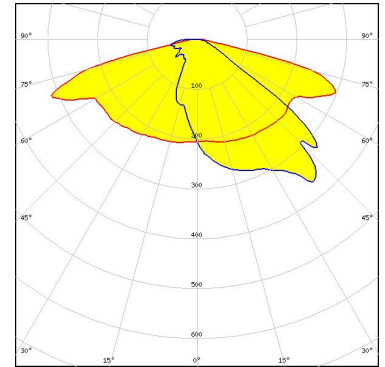

Light distribution files



LED XHP35 HD
FWHM / FWTM Asymmetric
Efficiency 93 %
Peak intensity 0.9 cd/lm
LEDs/each optic 1
Light colour/type White
Required components:

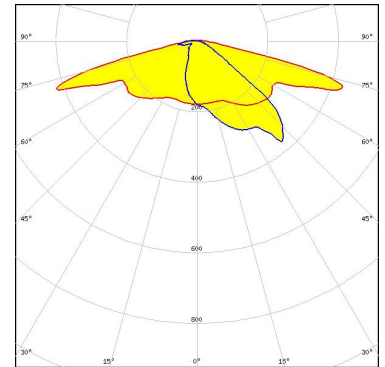

Light distribution files



LED XHP50
FWHM / FWTM Asymmetric
Efficiency 92 %
Peak intensity 0.6 cd/lm
LEDs/each optic 1
Light colour/type White
Required components:

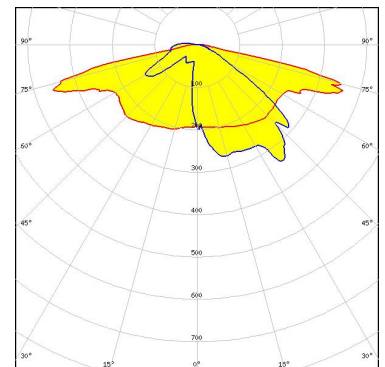

Light distribution files

OPTICAL RESULTS (MEASURED):

LUMILEDS

LED LUXEON M/MX
FWHM / FWTM Asymmetric
Efficiency 92 %
Peak intensity 0.7 cd/lm
LEDs/each optic 1
Light colour/type White
Required components:

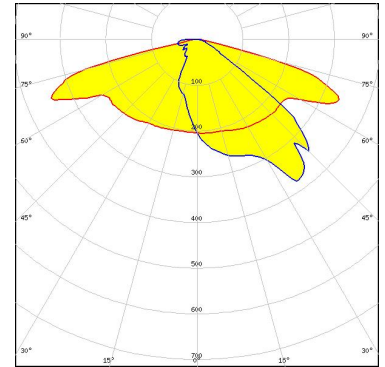

Light distribution files

LUMILEDS

LED LUXEON MZ
FWHM / FWTM Asymmetric
Efficiency 93 %
Peak intensity 1 cd/lm
LEDs/each optic 1
Light colour/type White
Required components:

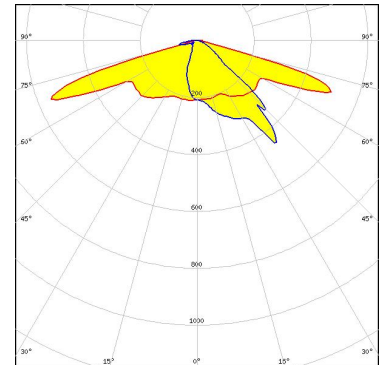

Light distribution files

LUMILEDS

LED LUXEON XR-M Linear (L2M0-xxxx003MC3300)
FWHM / FWTM Asymmetric
Efficiency 93 %
Peak intensity 0.7 cd/lm
LEDs/each optic 1
Light colour/type White
Required components:

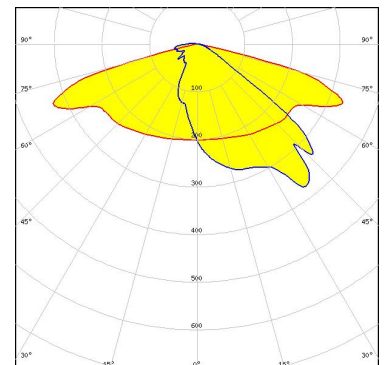

Light distribution files

OPTICAL RESULTS (MEASURED):



LED NV4x144A
FWHM / FWTM Asymmetric
Efficiency 91 %
Peak intensity 0.5 cd/lm
LEDs/each optic 1
Light colour/type White
Required components:

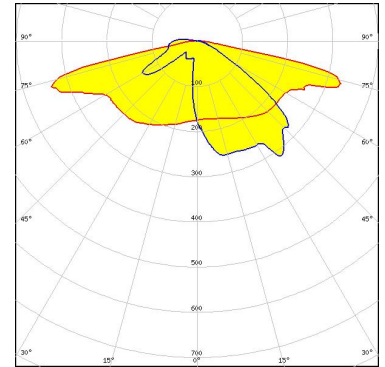

Light distribution files



LED NVSW319B
FWHM / FWTM Asymmetric
Efficiency 91 %
Peak intensity 0.9 cd/lm
LEDs/each optic 1
Light colour/type White
Required components:

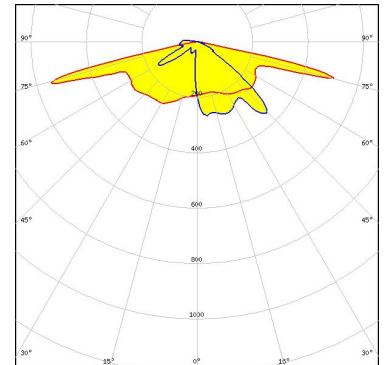

Light distribution files



LED Duris S10
FWHM / FWTM Asymmetric
Efficiency 90 %
Peak intensity 0.5 cd/lm
LEDs/each optic 1
Light colour/type White
Required components:

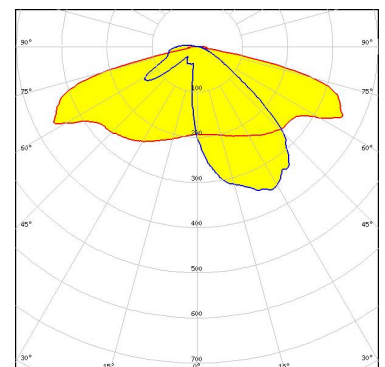

Light distribution files

OPTICAL RESULTS (SIMULATED):



LED J Series 5050 Round LES
 FWHM / FWTM Asymmetric
 Efficiency 94 %
 Peak intensity 0.7 cd/lm
 LEDs/each optic 1
 Light colour/type White
 Required components:

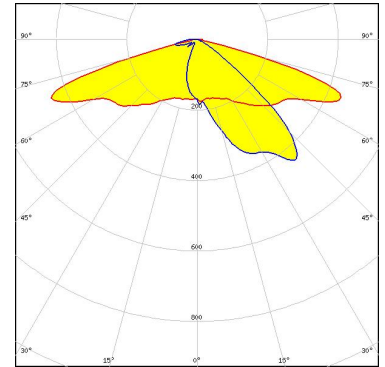

Light distribution files



LED J Series 5050B 6V K Class
 FWHM / FWTM Asymmetric
 Efficiency 94 %
 Peak intensity 0.7 cd/lm
 LEDs/each optic 1
 Light colour/type White
 Required components:

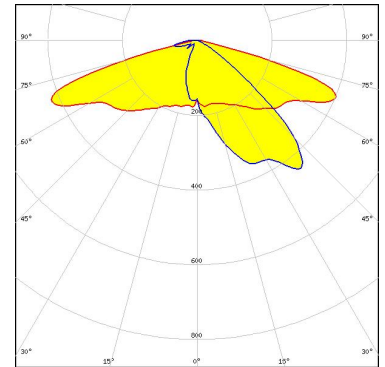

Light distribution files



LED J Series 7070B K Class
 FWHM / FWTM Asymmetric
 Efficiency 81 %
 Peak intensity 0.4 cd/lm
 LEDs/each optic 1
 Light colour/type White
 Required components:

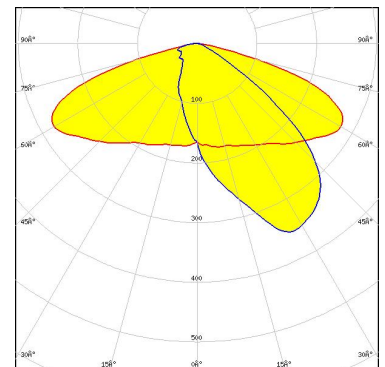

Protective plate, glass

Light distribution files

OPTICAL RESULTS (SIMULATED):



LED J Series 7070B K Class
 FWHM / FWTM Asymmetric
 Efficiency 94 %
 Peak intensity 0.5 cd/lm
 LEDs/each optic 1
 Light colour/type White
 Required components:

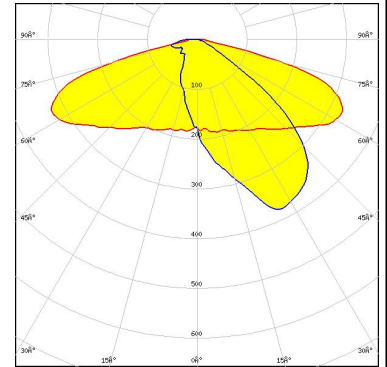

Light distribution files



LED MHB-A/B
 FWHM / FWTM Asymmetric
 Efficiency %
 LEDs/each optic 1
 Light colour/type White
 Required components:

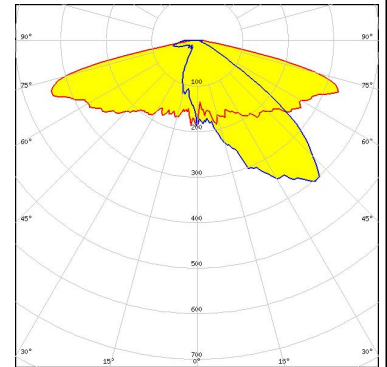

Light distribution files



LED XM-L2
 FWHM / FWTM Asymmetric
 Efficiency 94 %
 Peak intensity 0.8 cd/lm
 LEDs/each optic 1
 Light colour/type White
 Required components:

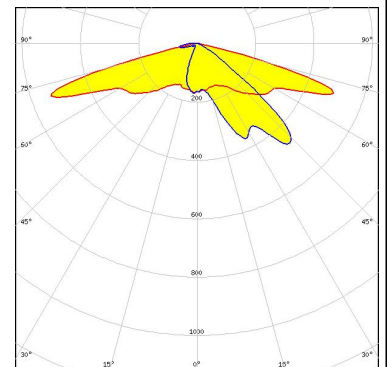

Light distribution files

OPTICAL RESULTS (SIMULATED):

LUMILEDS

LED LUXEON 5050 Round LES
FWHM / FWTM Asymmetric
Efficiency 94 %
Peak intensity 0.8 cd/lm
LEDs/each optic 1
Light colour/type White
Required components:

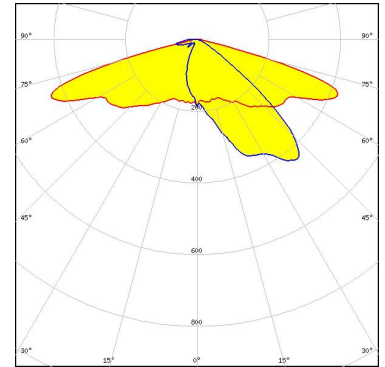

Light distribution files

LUMILEDS

LED LUXEON 7070
FWHM / FWTM Asymmetric
Efficiency 82 %
Peak intensity 0.4 cd/lm
LEDs/each optic 1
Light colour/type White
Required components:

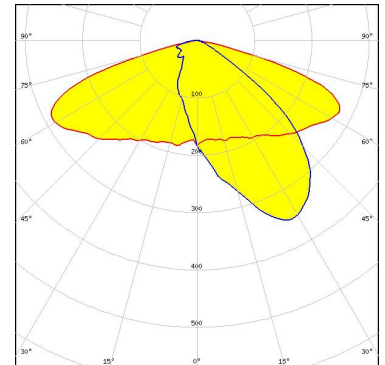

Protective plate, glass

Light distribution files

LUMILEDS

LED LUXEON M/MX
FWHM / FWTM Asymmetric
Efficiency 78 %
Peak intensity 0.5 cd/lm
LEDs/each optic 1
Light colour/type White
Required components:

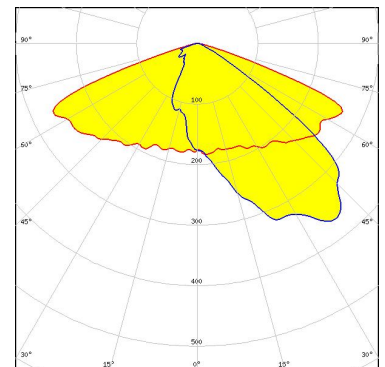

Protective plate, glass

Light distribution files

OPTICAL RESULTS (SIMULATED):



LED NVSxx19B/NVSxx19C
FWHM / FWTM Asymmetric
Efficiency 92 %
Peak intensity 1 cd/lm
LEDs/each optic 1
Light colour/type White
Required components:

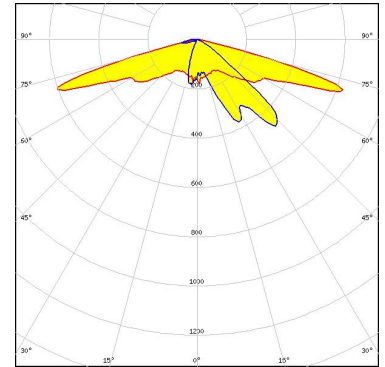

Light distribution files



LED OSCONIQ P 7070
FWHM / FWTM Asymmetric
Efficiency 91 %
Peak intensity 0.6 cd/lm
LEDs/each optic 1
Light colour/type White
Required components:

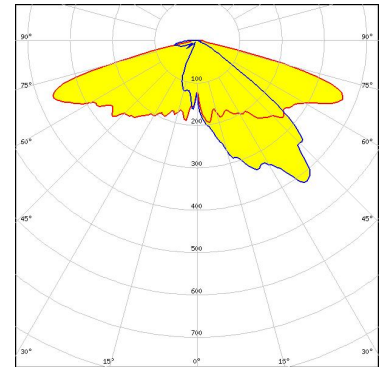

Light distribution files

GENERAL INFORMATION:

NOTE: The typical beam angle will be changed by different color, chip size and chip position tolerance. The typical total beam angle is the full angle measured where the luminous intensity is half of the peak value.

MATERIALS:

As part of our continuous research and improvement processes, and to ensure the best possible quality and availability of our products, LEDiL reserves the right to change material grades without notice.

PRODUCT DATA USER AGREEMENT AND DISCLAIMER:

The measured data in the provided downloadable LEDiL Product Datasheets and Mechanical 2D-Drawings is rounded and provided as reference for planning. LEDiL Oy's optical specifications have been verified by conducting performance testing of the products in accordance with the company's quality system. The reported data are averaged results of multiple measurements with typical variation. LEDiL Oy reserves the right to without prior notification make changes and improvements to its products.

LEDiL Oy assumes neither warranty, nor guarantee nor any other liability of any kind for the contents and correctness of the provided data. The provided data has been generated with highest diligence but the provided data may in reality not represent the complete possible variation range of all intrinsic parameters. Therefore, in certain cases a deviation from the provided data could occur.

LEDiL Oy reserves the right to undertake technical changes of its products without further notification which could lead to changes in the provided data. LEDiL Oy assumes no liability of any kind for the possible deviation from any provided data or any other damage resulting from the usage of the provided data.

The user agrees to this disclaimer and user agreement with the download or usage of the provided files.

LEDiL Oy

Joensuunkatu 13
FI-24240 SALO
Finland

LEDiL Inc.

228 West Page Street
Suite D
Sycamore IL 60178
USA

Ledil Optics Technology (Shenzhen) Co., Ltd.

405 , Block B
Casic Motor Building
Shenzhen 518057
P.R.CHINA

Local sales and technical support

[www.ledil.com/
where_to_buy](http://www.ledil.com/where_to_buy)

Shipping locations

Poznan, Poland
Hong Kong, China

Distribution Partners

[www.ledil.com/
where_to_buy](http://www.ledil.com/where_to_buy)