

## STRADA-SQ-ME

Beam with excellent longitudinal luminance uniformity fulfilling EN13201 M-class requirements where road width is equal to or less than the pole height. Version with location pins.

### SPECIFICATION:

Dimensions	25.0 x 25.0 mm
Height	8.6 mm
Fastening	pin, screw
ROHS compliant	yes ⓘ



### MATERIALS:

Component	Type	Material	Colour	Finish	Length
STRADA-SQ-ME	Single lens	PMMA	clear		25.0

### ORDERING INFORMATION:

Component	Qty in box	MOQ	MPQ	Box weight (kg)
C14020_STRADA-SQ-ME » Box size: 480 x 280 x 300 mm	2058	294	98	8.3

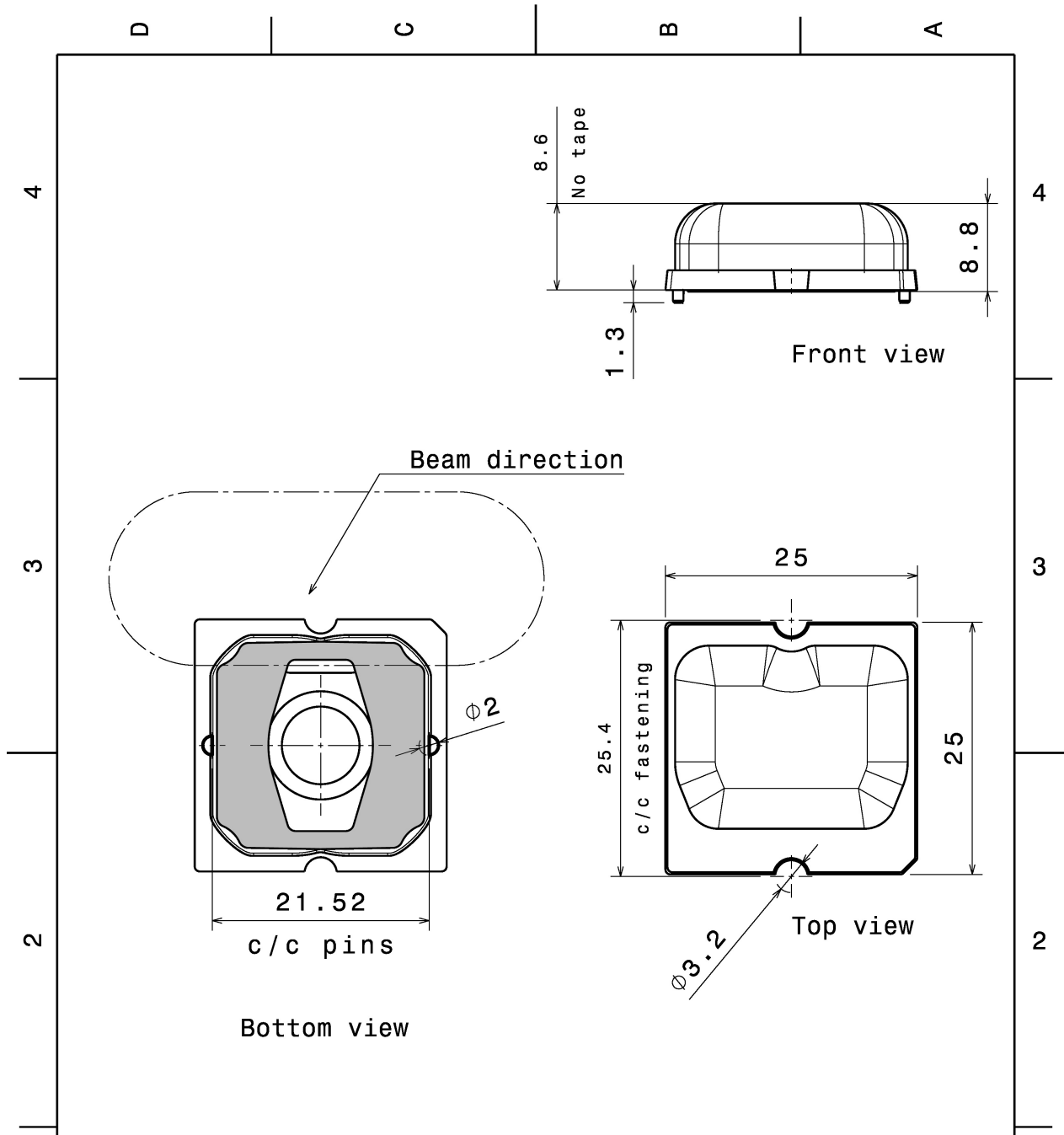

Tolerances if not otherwise shown  
 According to DIN ISO 2768-1  
 Linear measures:  
 Up to 30mm class M, otherwise class C.  
 According to DIN ISO 2768-2  
 Form and position: class L

**LEDiL** Ledil Oy  
 Salorankatu 10  
 FIN 24240 SALO  
 Finland

THIRD ANGLE PROJECTION:

DRAWING TITLE  
**STRADA-SQ-ME\_Mechanicaldrawing**

This drawing is the property of LEDiL Oy. It may not be reproduced, copied or communicated without a written agreement with LEDiL Oy."

SIZE	PART NUMBER
A4	-

SCALE	2:1	WEIGHT	-	SHEET	1/1
-------	-----	--------	---	-------	-----

See also our general installation guide: [www.ledil.com/installation\\_guide](http://www.ledil.com/installation_guide)

### OPTICAL RESULTS (MEASURED):



LED XHP50  
FWHM / FWTM Asymmetric  
Efficiency 94 %  
Peak intensity 0.6 cd/lm  
LEDs/each optic 1  
Light colour/type White  
Required components:

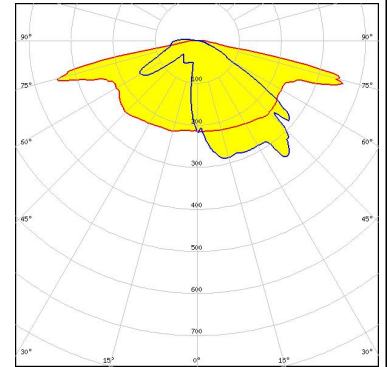

Light distribution files



LED LUXEON MZ  
FWHM / FWTM Asymmetric  
Efficiency 93 %  
Peak intensity 1 cd/lm  
LEDs/each optic 1  
Light colour/type White  
Required components:

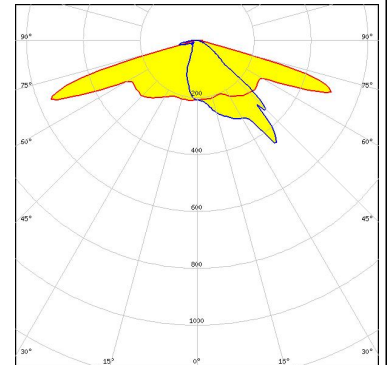

Light distribution files

### OPTICAL RESULTS (SIMULATED):



LED MHB-A/B  
FWHM / FWTM Asymmetric  
Efficiency %  
LEDs/each optic 1  
Light colour/type White  
Required components:

Light distribution files



LED MK-R  
FWHM / FWTM Asymmetric  
Efficiency 91 %  
LEDs/each optic 1  
Light colour/type White  
Required components:

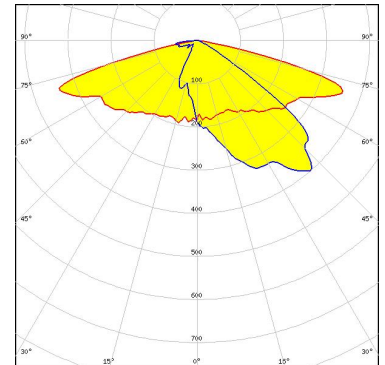

Light distribution files



LED XHP50.3 HD  
FWHM / FWTM Asymmetric  
Efficiency 94 %  
Peak intensity 0.6 cd/lm  
LEDs/each optic 1  
Light colour/type White  
Required components:

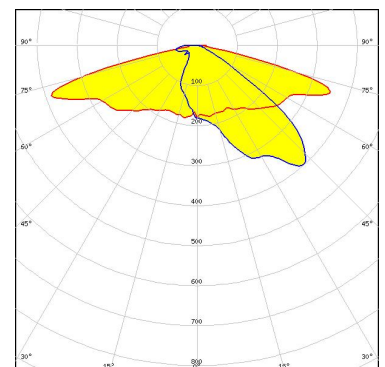

Light distribution files

### OPTICAL RESULTS (SIMULATED):



LED XHP70.3 HD  
FWHM / FWTM Asymmetric  
Efficiency 93 %  
Peak intensity 0.5 cd/lm  
LEDs/each optic 1  
Light colour/type White  
Required components:

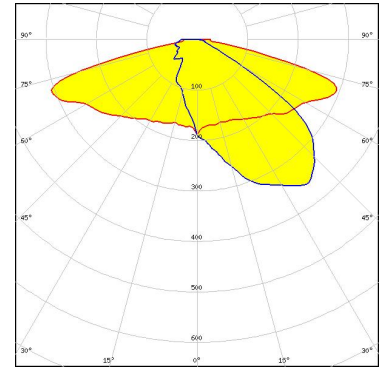

Light distribution files



LED XP-G3  
FWHM / FWTM Asymmetric  
Efficiency 94 %  
Peak intensity 0.9 cd/lm  
LEDs/each optic 1  
Light colour/type White  
Required components:

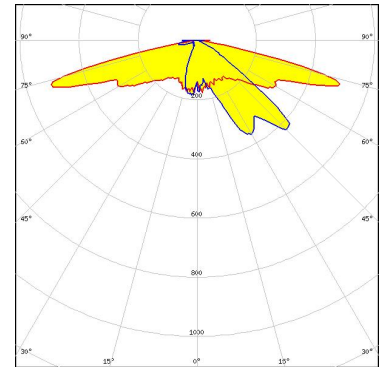

Light distribution files



LED LUXEON 5050 Round LES  
FWHM / FWTM Asymmetric  
Efficiency 93 %  
Peak intensity 0.7 cd/lm  
LEDs/each optic 1  
Light colour/type White  
Required components:

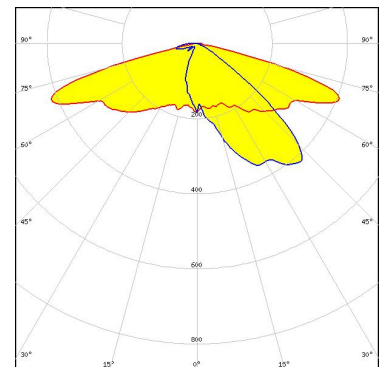

Light distribution files

### OPTICAL RESULTS (SIMULATED):



LED LUXEON 7070  
FWHM / FWTM Asymmetric  
Efficiency 96 %  
Peak intensity 0.5 cd/lm  
LEDs/each optic 1  
Light colour/type White  
Required components:

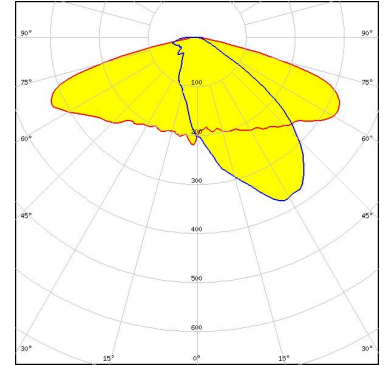

Light distribution files



LED LUXEON M/MX  
FWHM / FWTM Asymmetric  
Efficiency 90 %  
LEDs/each optic 1  
Light colour/type White  
Required components:

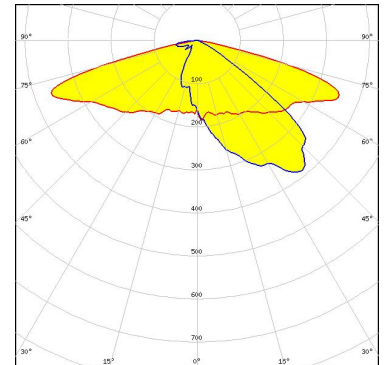

Light distribution files



LED MP 7070  
FWHM / FWTM Asymmetric  
Efficiency 96 %  
Peak intensity 0.6 cd/lm  
LEDs/each optic 1  
Light colour/type White  
Required components:

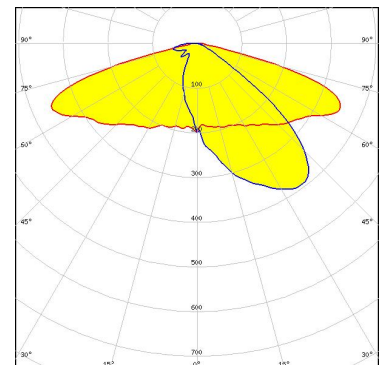

Light distribution files

### OPTICAL RESULTS (SIMULATED):



LED MP 7070  
FWHM / FWTM Asymmetric  
Efficiency 82 %  
Peak intensity 0.4 cd/lm  
LEDs/each optic 1  
Light colour/type White  
Required components:

Protective plate, glass

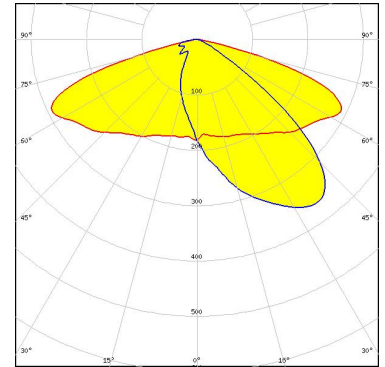

Light distribution files



LED NVSW519A  
FWHM / FWTM Asymmetric  
Efficiency 93 %  
Peak intensity 0.8 cd/lm  
LEDs/each optic 1  
Light colour/type White  
Required components:

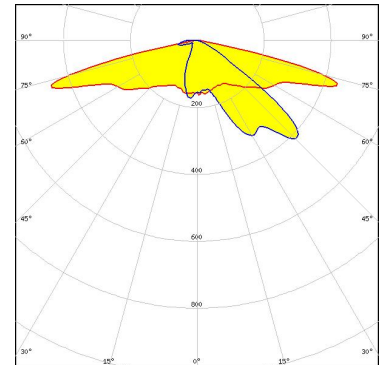

Light distribution files



LED NVSxx19B/NVSxx19C  
FWHM / FWTM Asymmetric  
Efficiency 94 %  
Peak intensity 1 cd/lm  
LEDs/each optic 1  
Light colour/type White  
Required components:

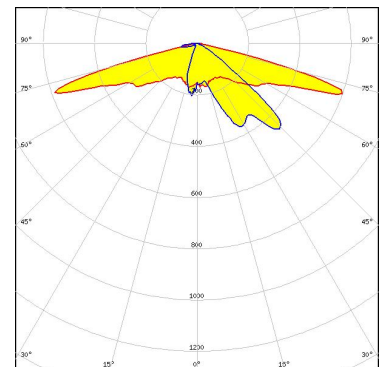

Light distribution files

### OPTICAL RESULTS (SIMULATED):

**OSRAM**  
Opto Semiconductors

LED Duris S8  
FWHM / FWTM Asymmetric  
Efficiency 93 %  
LEDs/each optic 1  
Light colour/type White  
Required components:

Light distribution files

**OSRAM**  
Opto Semiconductors

LED OSCONIQ P 7070  
FWHM / FWTM Asymmetric  
Efficiency 92 %  
Peak intensity 0.7 cd/lm  
LEDs/each optic 1  
Light colour/type White  
Required components:

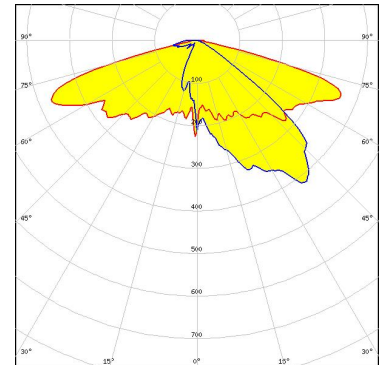

Light distribution files

**OSRAM**  
Opto Semiconductors

LED OSLON Square CSSRM2/CSSRM3  
FWHM / FWTM Asymmetric  
Efficiency 94 %  
Peak intensity 0.8 cd/lm  
LEDs/each optic 1  
Light colour/type White  
Required components:

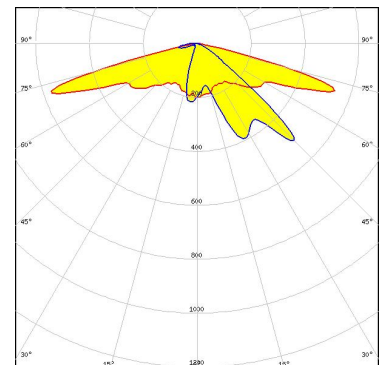

Light distribution files



#### OPTICAL RESULTS (SIMULATED):

### SAMSUNG

LED	LH181B
FWHM / FWTM	Asymmetric
Efficiency	82 %
Peak intensity	0.5 cd/lm
LEDs/each optic	4
Light colour/type	White

Required components:

Protective plate, glass

Light distribution files

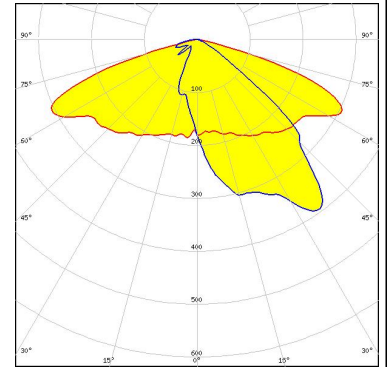

### GENERAL INFORMATION:

NOTE: The typical beam angle will be changed by different color, chip size and chip position tolerance. The typical total beam angle is the full angle measured where the luminous intensity is half of the peak value.

### MATERIALS:

As part of our continuous research and improvement processes, and to ensure the best possible quality and availability of our products, LEDiL reserves the right to change material grades without notice.

### PRODUCT DATA USER AGREEMENT AND DISCLAIMER:

The measured data in the provided downloadable LEDiL Product Datasheets and Mechanical 2D-Drawings is rounded and provided as reference for planning. LEDiL Oy's optical specifications have been verified by conducting performance testing of the products in accordance with the company's quality system. The reported data are averaged results of multiple measurements with typical variation. LEDiL Oy reserves the right to without prior notification make changes and improvements to its products.

LEDiL Oy assumes neither warranty, nor guarantee nor any other liability of any kind for the contents and correctness of the provided data. The provided data has been generated with highest diligence but the provided data may in reality not represent the complete possible variation range of all intrinsic parameters. Therefore, in certain cases a deviation from the provided data could occur.

LEDiL Oy reserves the right to undertake technical changes of its products without further notification which could lead to changes in the provided data. LEDiL Oy assumes no liability of any kind for the possible deviation from any provided data or any other damage resulting from the usage of the provided data.

The user agrees to this disclaimer and user agreement with the download or usage of the provided files.

#### LEDiL Oy

Joensuunkatu 13  
FI-24240 SALO  
Finland

#### LEDiL Inc.

228 West Page Street  
Suite D  
Sycamore IL 60178  
USA

#### Ledil Optics Technology (Shenzhen) Co., Ltd.

# 405 , Block B  
Casic Motor Building  
Shenzhen 518057  
P.R.CHINA

#### Local sales and technical support

[www.ledil.com/  
where\\_to\\_buy](http://www.ledil.com/where_to_buy)

#### Shipping locations

Poznan, Poland  
Hong Kong, China

#### Distribution Partners

[www.ledil.com/  
where\\_to\\_buy](http://www.ledil.com/where_to_buy)