

VERONICA-SQ-O

~55° + 12° oval beam

SPECIFICATION:

Dimensions	Ø 22.5 mm
Height	12.2 mm
Fastening	tape, pin
ROHS compliant	yes ⓘ

MATERIALS:

Component	Type	Material	Colour	Finish	Length
VERONICA-SQ-O	Single lens	PMMA	clear		22.5
VERONICA-TAPE	Tape	Acrylic foam	clear		22.0



ORDERING INFORMATION:

Component	Type	Qty in box	MOQ	MPQ	Box weight (kg)
CA13726_VERONICA-SQ-O » Box size: 476 x 273 x 197 mm	Single lens	1980	360	90	8.2

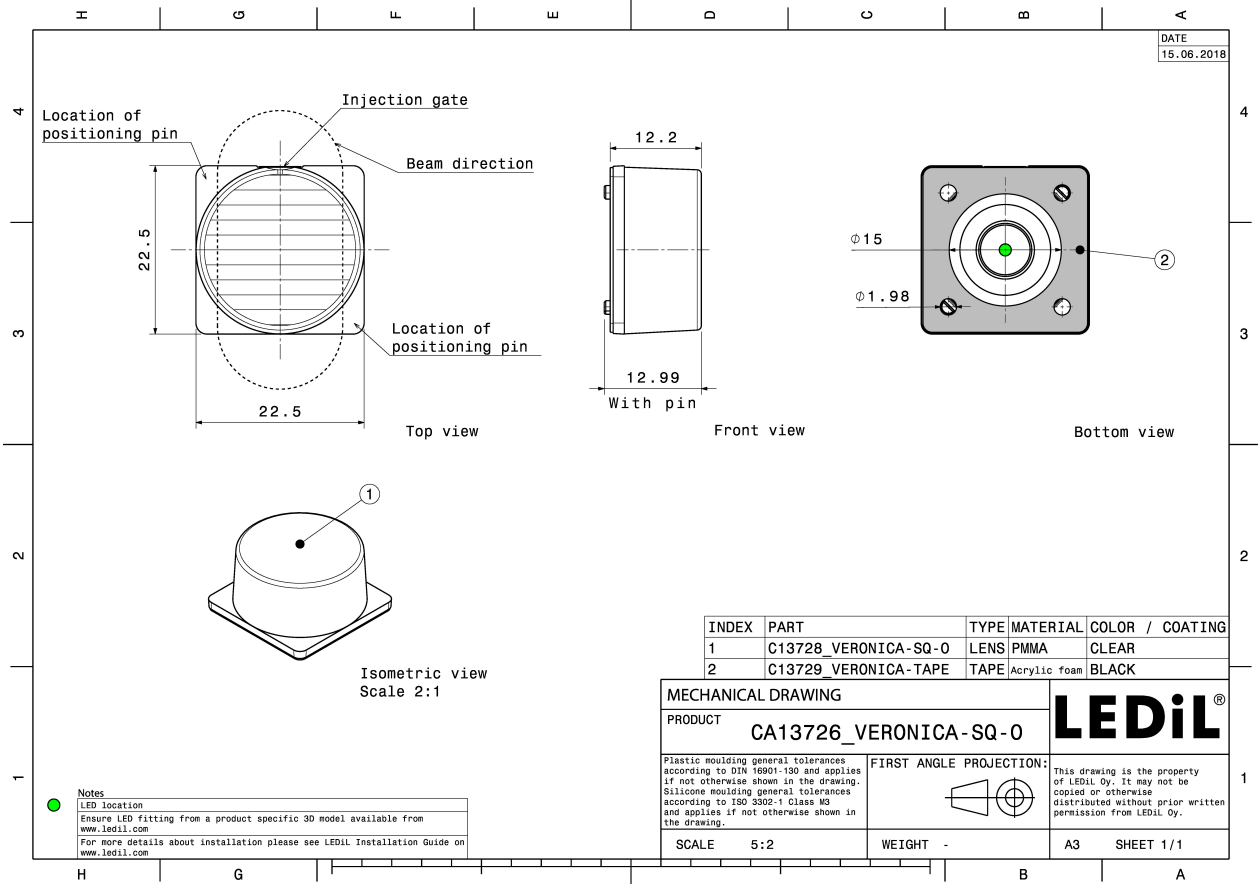

See also our general installation guide: www.ledil.com/installation_guide

OPTICAL RESULTS (MEASURED):



LED XB-H
FWHM / FWTM 45.0 + 16.0° / 73.0 + 40.0°
Efficiency 77 %
Peak intensity 2.7 cd/lm
LEDs/each optic 1
Light colour/type White
Required components:

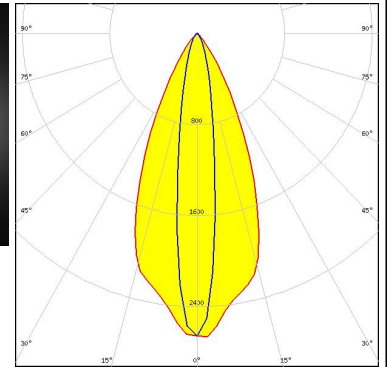
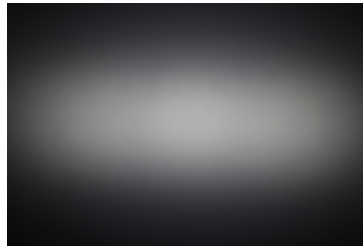

Light distribution files



LED XD16
FWHM / FWTM 47.0 + 17.0° / 76.0 + 41.0°
Efficiency 87 %
Peak intensity 2.2 cd/lm
LEDs/each optic 1
Light colour/type White
Required components:

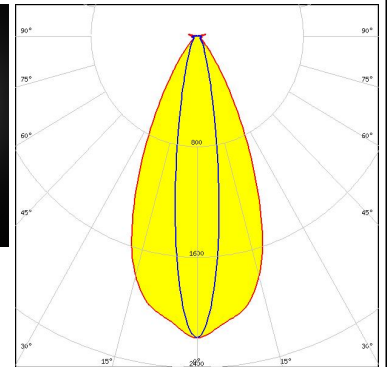
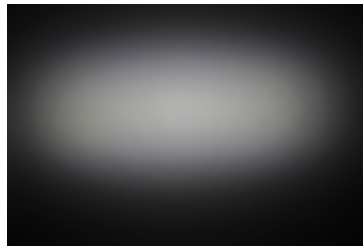

Light distribution files



LED XHP35 HD
FWHM / FWTM 45.0 + 20.0° / 78.0 + 48.0°
Efficiency 73 %
Peak intensity 2.1 cd/lm
LEDs/each optic 1
Light colour/type White
Required components:

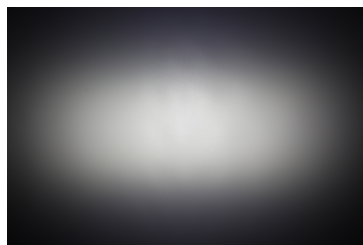

Light distribution files

OPTICAL RESULTS (MEASURED):



LED XHP35 HI
 FWHM / FWTM 46.0 + 16.0° / 74.0 + 40.0°
 Efficiency 75 %
 Peak intensity 2.7 cd/m
 LEDs/each optic 1
 Light colour/type White
 Required components:



Light distribution files



LED XM-L
 FWHM / FWTM 47.0 + 20.0° / 77.0 + 46.0°
 Efficiency 80 %
 Peak intensity 2.3 cd/m
 LEDs/each optic 1
 Light colour/type White
 Required components:

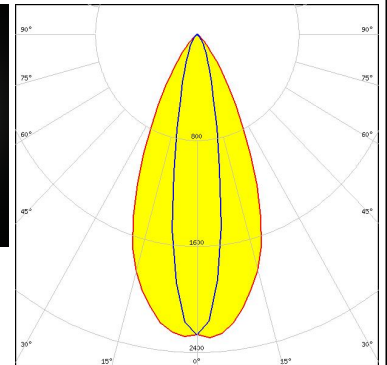

Light distribution files



LED XM-L2
 FWHM / FWTM 47.0 + 20.0° / 76.0 + 45.0°
 Efficiency 80 %
 Peak intensity 2.3 cd/m
 LEDs/each optic 1
 Light colour/type White
 Required components:

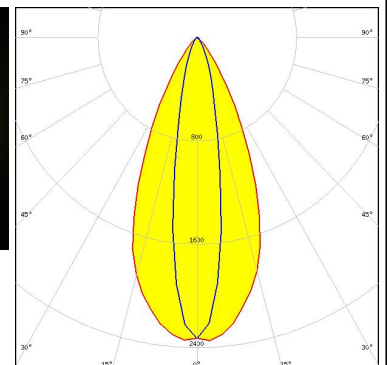
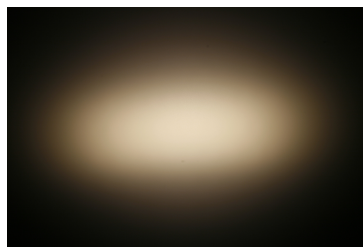

Light distribution files

OPTICAL RESULTS (MEASURED):



LED XM-L3
FWHM / FWTM 47.0 + 19.0° / 77.0 + 46.0°
Efficiency 88 %
Peak intensity 2.2 cd/lm
LEDs/each optic 1
Light colour/type White
Required components:

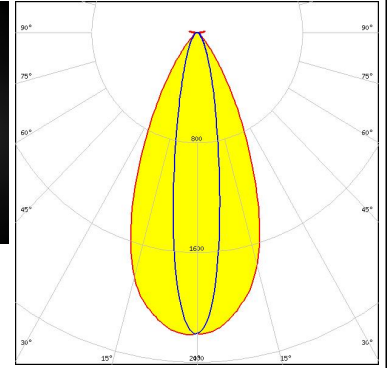

Light distribution files



LED XP-E2
FWHM / FWTM 46.0 + 12.0° / 71.0 + 34.0°
Efficiency 80 %
Peak intensity 3.5 cd/lm
LEDs/each optic 1
Light colour/type White
Required components:

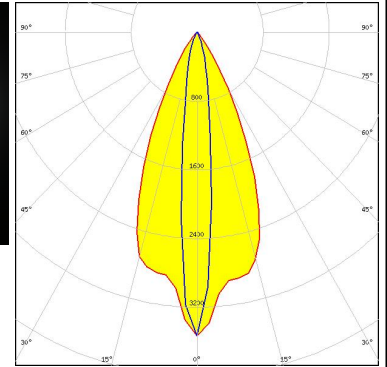

Light distribution files



LED XP-G2
FWHM / FWTM 47.0 + 14.0° / 76.0 + 40.0°
Efficiency 80 %
Peak intensity 2.9 cd/lm
LEDs/each optic 1
Light colour/type White
Required components:

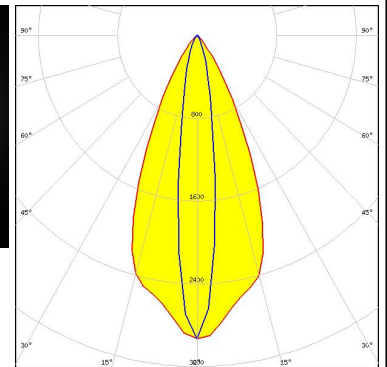
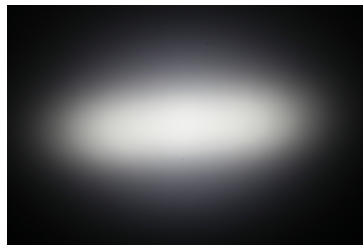

Light distribution files

OPTICAL RESULTS (MEASURED):



LED XP-L2
 FWHM / FWTM 45.0 + 20.0° / 78.0 + 49.0°
 Efficiency 86 %
 Peak intensity 1.9 cd/lm
 LEDs/each optic 1
 Light colour/type White
 Required components:

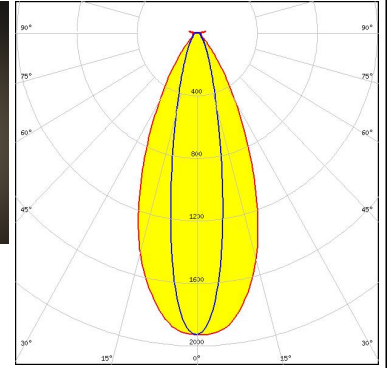
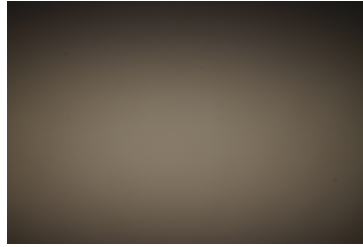

Light distribution files



LED XT-E
 FWHM / FWTM 47.0 + 16.0° / 74.0 + 40.0°
 Efficiency 79 %
 Peak intensity 2.8 cd/lm
 LEDs/each optic 1
 Light colour/type White
 Required components:

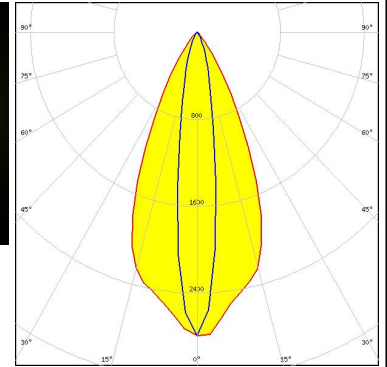

Light distribution files



LED LUXEON M/MX
 FWHM / FWTM 45.0 + 28.0° / 81.0 + 60.0°
 Efficiency 76 %
 Peak intensity 1.6 cd/lm
 LEDs/each optic 1
 Light colour/type White
 Required components:

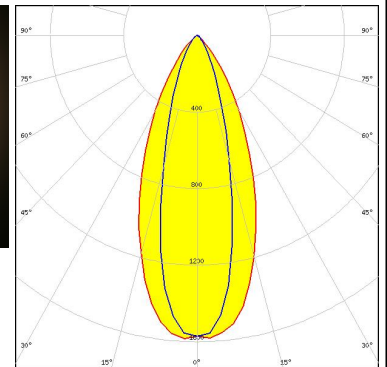
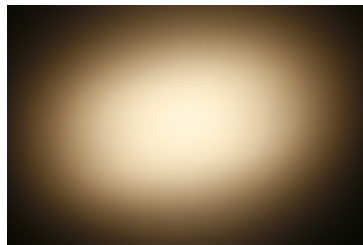

Light distribution files

OPTICAL RESULTS (MEASURED):



LED LUXEON MZ
FWHM / FWTM 47.0 + 23.0° / 77.0 + 46.0°
Efficiency 73 %
Peak intensity 2 cd/lm
LEDs/each optic 1
Light colour/type White
Required components:

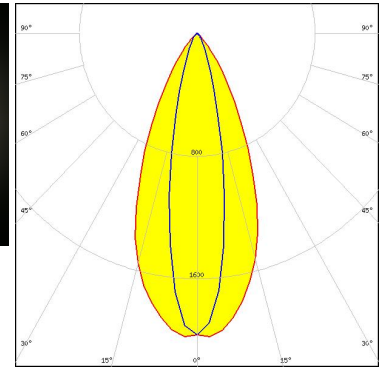
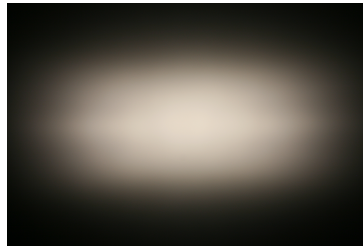

Light distribution files



LED LUXEON Rebel
FWHM / FWTM 47.0 + 15.0° / 72.0 + 38.0°
Efficiency 80 %
Peak intensity 3 cd/lm
LEDs/each optic 1
Light colour/type White
Required components:

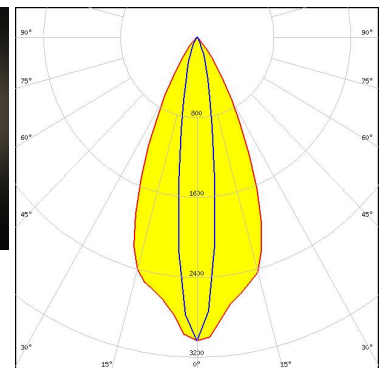
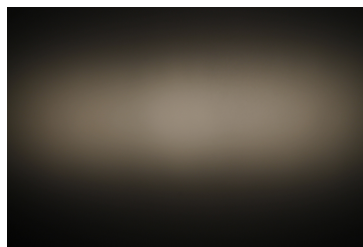

Light distribution files



LED LUXEON Rebel ES
FWHM / FWTM 47.0 + 17.0° / 74.0 + 39.0°
Efficiency 80 %
Peak intensity 2.7 cd/lm
LEDs/each optic 1
Light colour/type White
Required components:

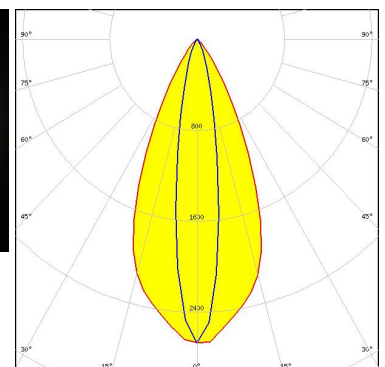
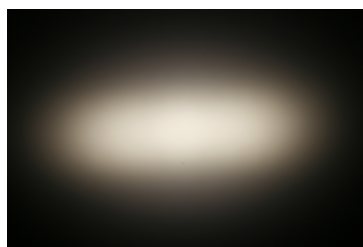

Light distribution files

OPTICAL RESULTS (MEASURED):



LED LUXEON T
FWHM / FWTM 47.0 + 17.0° / 74.0 + 39.0°
Efficiency 80 %
Peak intensity 2.8 cd/lm
LEDs/each optic 1
Light colour/type White
Required components:

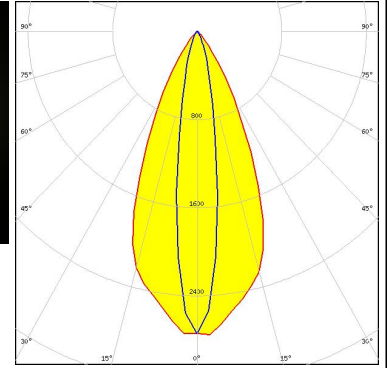

Light distribution files



LED LUXEON TX
FWHM / FWTM 46.0 + 16.0° / 73.0 + 37.0°
Efficiency 77 %
Peak intensity 2.8 cd/lm
LEDs/each optic 1
Light colour/type White
Required components:

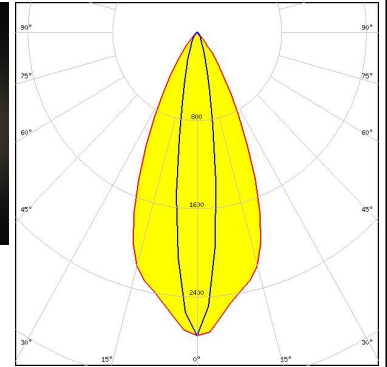

Light distribution files



LED LUXEON V
FWHM / FWTM 46.0 + 21.0° / 79.0 + 50.0°
Efficiency 88 %
Peak intensity 1.9 cd/lm
LEDs/each optic 1
Light colour/type White
Required components:

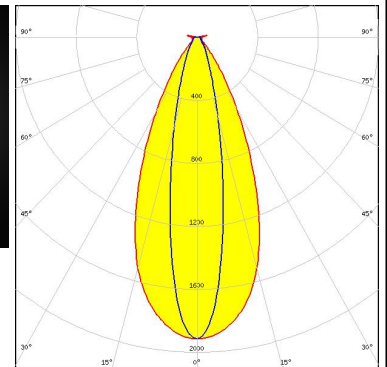
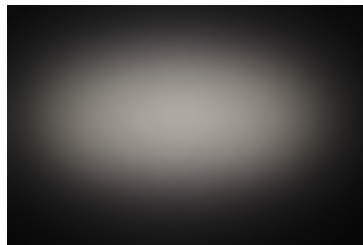

Light distribution files

OPTICAL RESULTS (MEASURED):



LED LUXEON V2
FWHM / FWTM 47.0 + 17.0° / 76.0 + 43.0°
Efficiency 87 %
Peak intensity 2.3 cd/lm
LEDs/each optic 1
Light colour/type White
Required components:

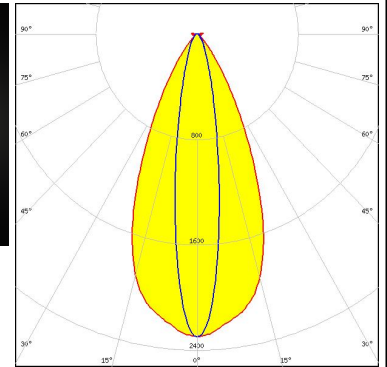
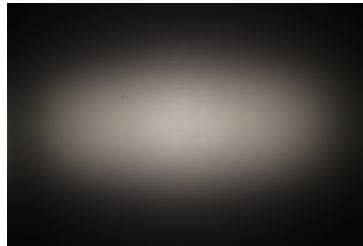

Light distribution files



LED NVSW219F
FWHM / FWTM 48.0 + 16.0° / 76.0 + 42.0°
Efficiency 88 %
Peak intensity 2.4 cd/lm
LEDs/each optic 1
Light colour/type White
Required components:

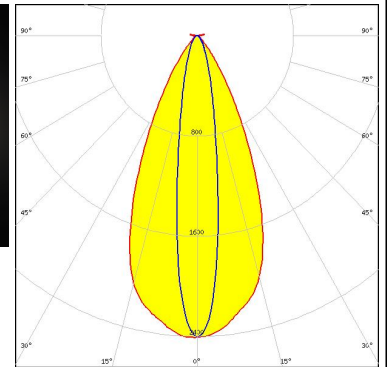
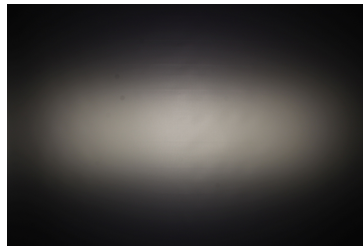

Light distribution files



LED NVSxx19B/NVSxx19C
FWHM / FWTM 47.0 + 18.0° / 74.0 + 37.0°
Efficiency 80 %
Peak intensity 2.6 cd/lm
LEDs/each optic 1
Light colour/type White
Required components:

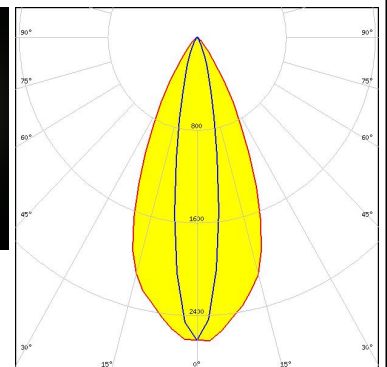
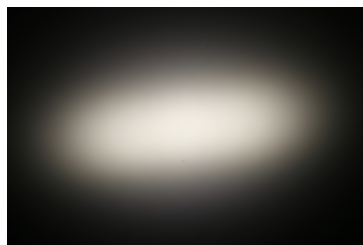

Light distribution files

OPTICAL RESULTS (MEASURED):



LED NWSx229A
 FWHM / FWTM 20.0 + 45.0° / 75.0 + 45.0°
 Efficiency 74 %
 Peak intensity 2 cd/lm
 LEDs/each optic 1
 Light colour/type White
 Required components:

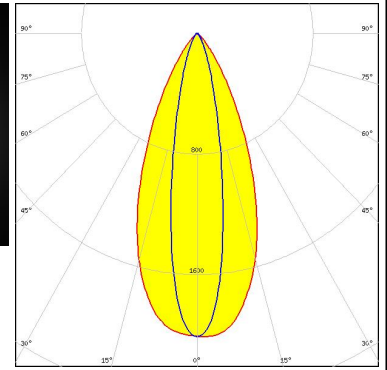

Light distribution files



LED OSOLON Square EC
 FWHM / FWTM 47.0 + 17.0° / 74.0 + 39.0°
 Efficiency 79 %
 Peak intensity 2.8 cd/lm
 LEDs/each optic 1
 Light colour/type White
 Required components:

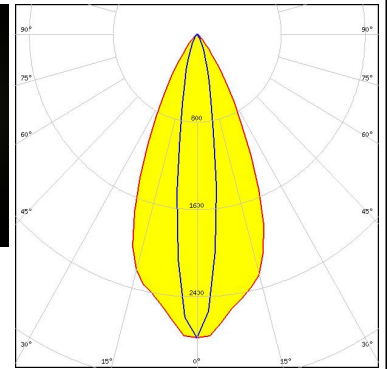

Light distribution files



LED LH181A
 FWHM / FWTM 46.0 + 22.0° / 79.0 + 48.0°
 Efficiency 85 %
 Peak intensity 1.7 cd/lm
 LEDs/each optic 1
 Light colour/type White
 Required components:

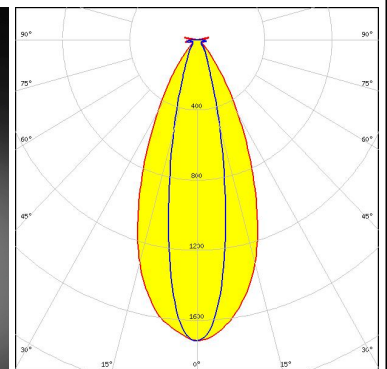
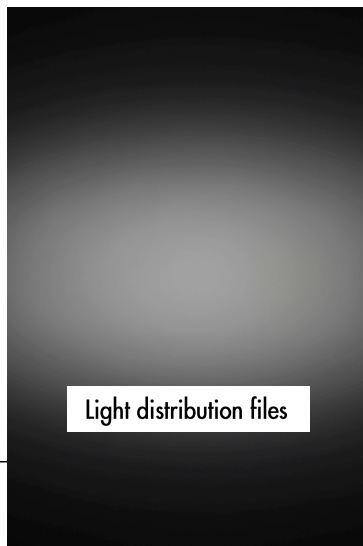

Light distribution files

OPTICAL RESULTS (MEASURED):

SAMSUNG

LED LH181B
 FWHM / FWTM 46.0 + 21.0° / 78.0 + 44.0°
 Efficiency 88 %
 Peak intensity 2 cd/lm
 LEDs/each optic 1
 Light colour/type White
 Required components:

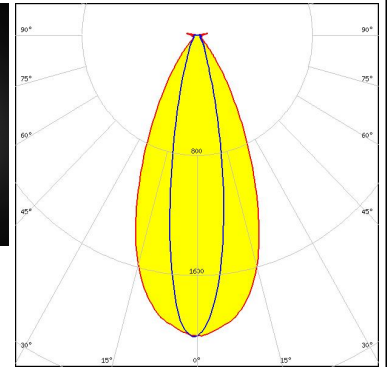

Light distribution files

SAMSUNG

LED LH351Z
 FWHM / FWTM 47.0 + 15.0° / 73.0 + 40.0°
 Efficiency 78 %
 Peak intensity 2.8 cd/lm
 LEDs/each optic 1
 Light colour/type White
 Required components:

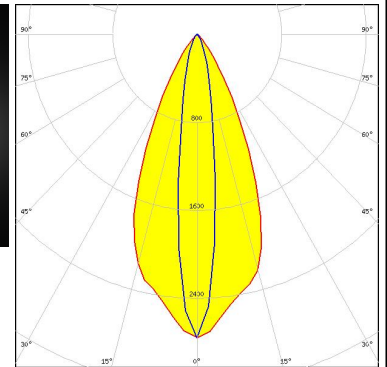

Light distribution files



LED MJT 5050
 FWHM / FWTM 45.0 + 28.0° / 82.0 + 60.0°
 Efficiency 87 %
 Peak intensity 1.6 cd/lm
 LEDs/each optic 1
 Light colour/type White
 Required components:

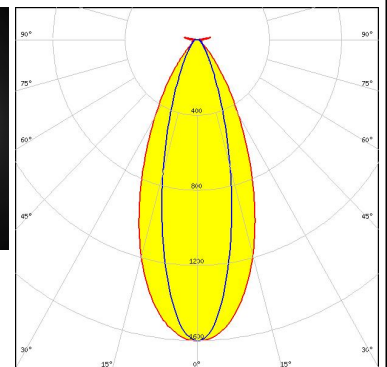
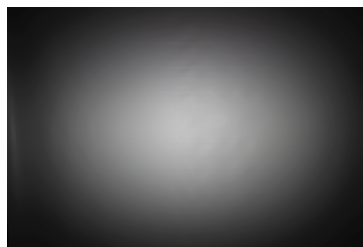

Light distribution files

OPTICAL RESULTS (MEASURED):

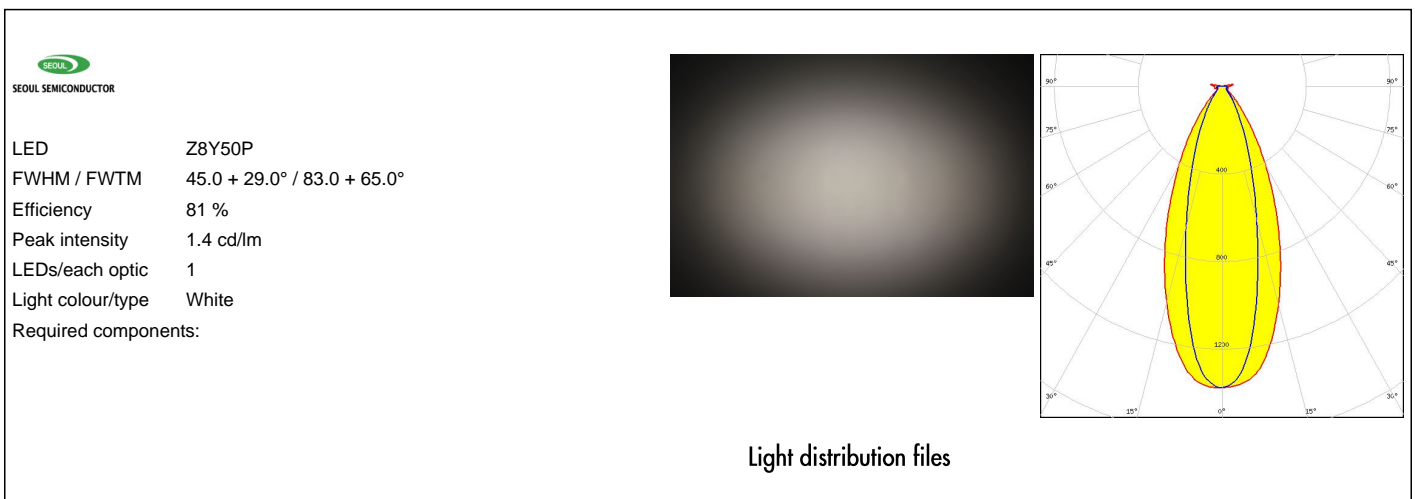
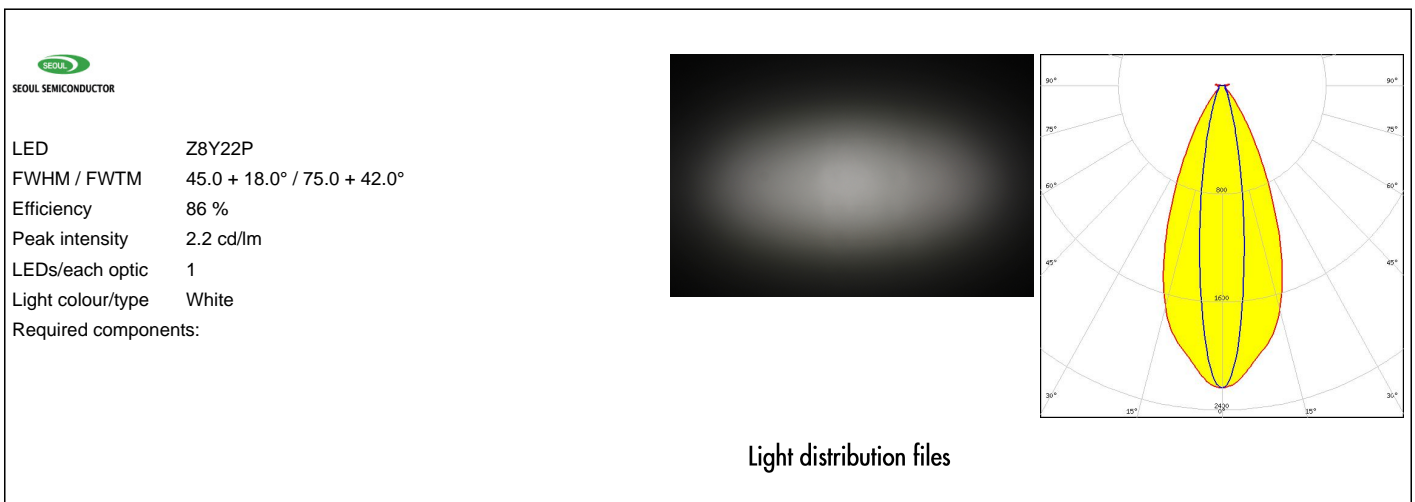
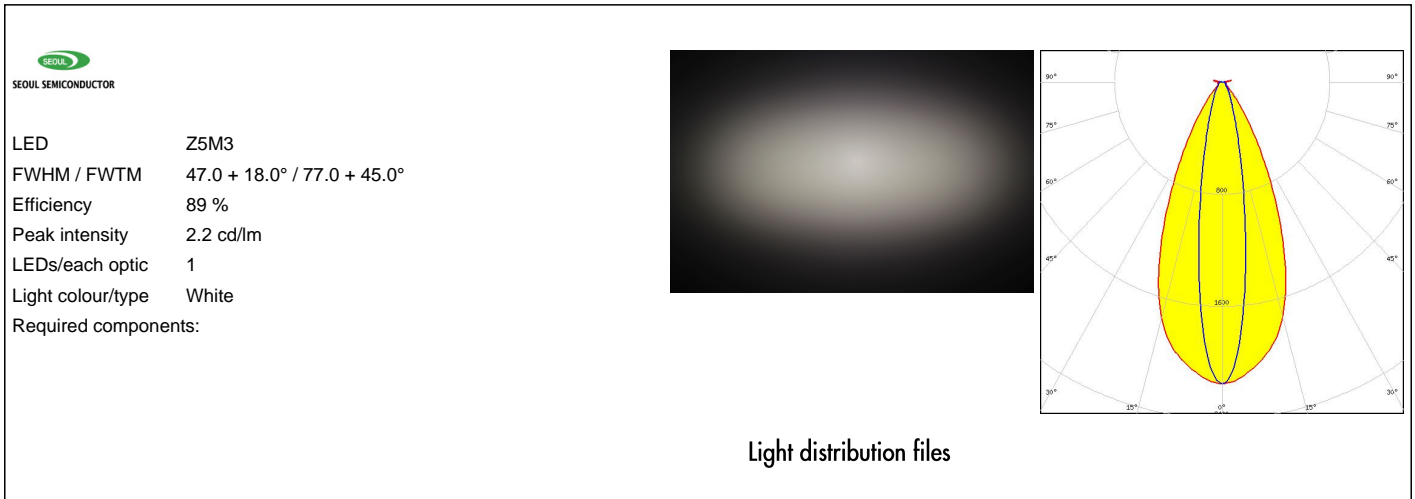

OPTICAL RESULTS (SIMULATED):



LED XP-G2 HE
 FWHM / FWTM 54.0 + 14.0° / 80.0 + 35.0°
 Efficiency 92 %
 Peak intensity 2.8 cd/lm
 LEDs/each optic 1
 Light colour/type White
 Required components:

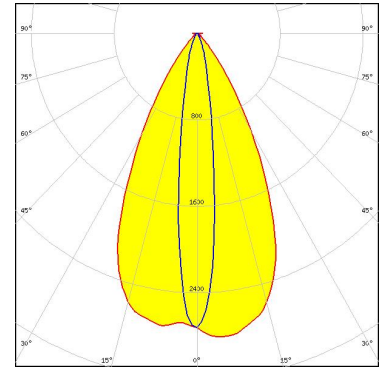

Light distribution files



LED XP-L HD
 FWHM / FWTM 53.0 + 16.0° / 82.0 + 38.0°
 Efficiency 86 %
 Peak intensity 2.5 cd/lm
 LEDs/each optic 1
 Light colour/type White
 Required components:

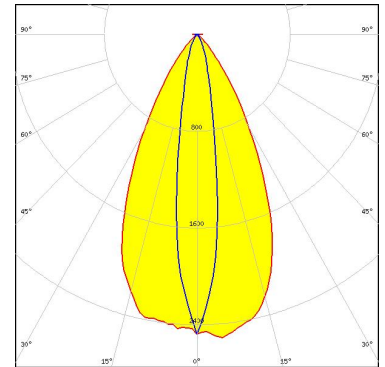

Light distribution files



LED XQ-E HD
 FWHM / FWTM 53.0 + 10.0° / 78.0 + 27.0°
 Efficiency 89 %
 Peak intensity 3.8 cd/lm
 LEDs/each optic 1
 Light colour/type White
 Required components:

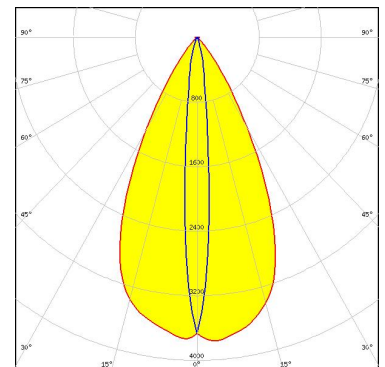

Light distribution files

OPTICAL RESULTS (SIMULATED):



LED XQ-E HI
 FWHM / FWTM 53.0 + 8.0° / 76.0 + 24.0°
 Efficiency 89 %
 Peak intensity 4.1 cd/lm
 LEDs/each optic 1
 Light colour/type White
 Required components:

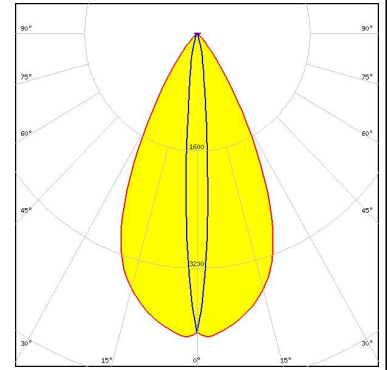

Light distribution files



LED LUXEON C
 FWHM / FWTM 46.0 + 27.0° / 85.0 + 53.0°
 Efficiency 84 %
 Peak intensity 1.7 cd/lm
 LEDs/each optic 4
 Light colour/type RGBW
 Required components:

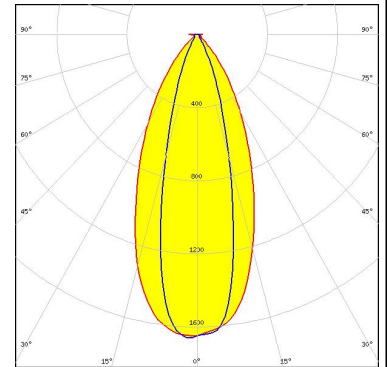

Light distribution files



LED LUXEON HL1Z
 FWHM / FWTM 56.0 + 14.0° / 80.0 + 26.0°
 Efficiency 89 %
 Peak intensity 3 cd/lm
 LEDs/each optic 1
 Light colour/type White
 Required components:

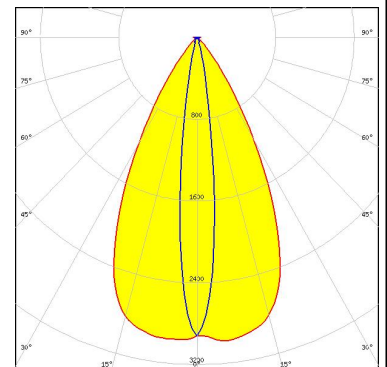

Light distribution files

OPTICAL RESULTS (SIMULATED):



LED SFT-40-WCS
FWHM / FWTM 54.0 + 10.0° / 78.0 + 26.0°
Efficiency 92 %
Peak intensity 3.7 cd/lm
LEDs/each optic 1
Light colour/type White
Required components:

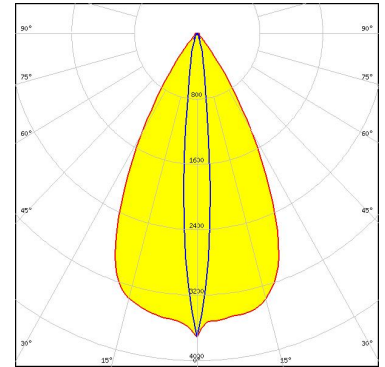

Light distribution files



LED SFT-70X-WCS
FWHM / FWTM 54.0 + 14.0° / 80.0 + 31.0°
Efficiency 92 %
Peak intensity 3 cd/lm
LEDs/each optic 1
Light colour/type White
Required components:

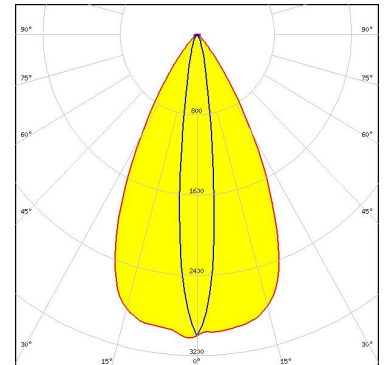

Light distribution files



LED NCSxE17A
FWHM / FWTM 50.0 + 24.0° / 84.0 + 48.0°
Efficiency 83 %
Peak intensity 1.8 cd/lm
LEDs/each optic 4
Light colour/type White
Required components:

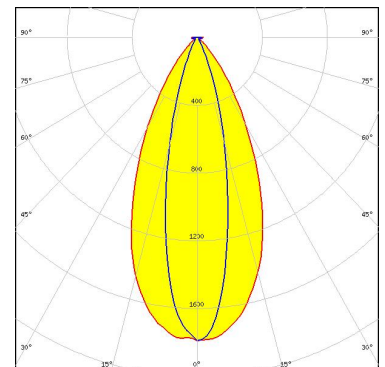

Light distribution files

OPTICAL RESULTS (SIMULATED):



LED NV4WB35AM
FWHM / FWTM 50.0 + 18.0° / 82.0 + 40.0°
Efficiency 88 %
Peak intensity 2.5 cd/lm
LEDs/each optic 1
Light colour/type White
Required components:

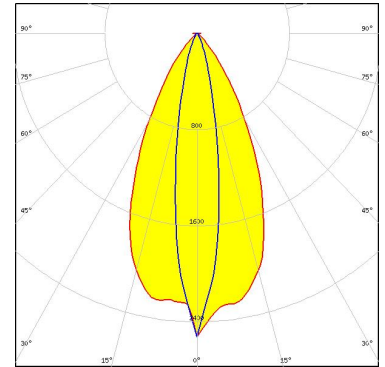

Light distribution files



LED OSCONIQ P 3030
FWHM / FWTM 56.0 + 12.0° / 79.0 + 26.0°
Efficiency 88 %
Peak intensity 3.4 cd/lm
LEDs/each optic 1
Light colour/type White
Required components:

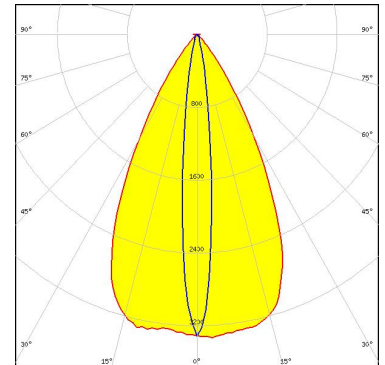

Light distribution files



LED OSCONIQ P 7070
FWHM / FWTM 49.0 + 25.0° / 83.0 + 53.0°
Efficiency 84 %
Peak intensity 1.8 cd/lm
LEDs/each optic 1
Light colour/type White
Required components:

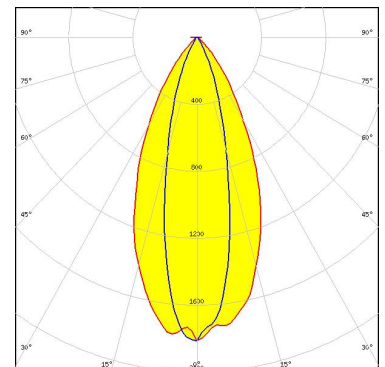

Light distribution files

OPTICAL RESULTS (SIMULATED):

OSRAM
Opto Semiconductors

LED OSLON Pure 1414
 FWHM / FWTM 56.0 + 8.0° / 76.0 + 22.0°
 Efficiency 92 %
 Peak intensity 4.3 cd/lm
 LEDs/each optic 1
 Light colour/type White
 Required components:

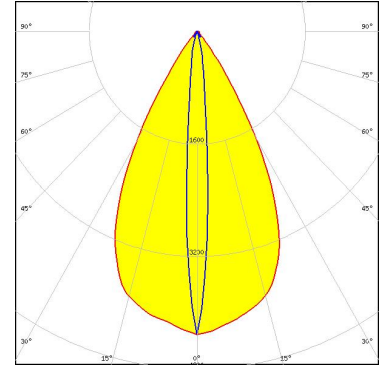

Light distribution files

OSRAM
Opto Semiconductors

LED OSLON Square CSSRM2/CSSRM3
 FWHM / FWTM 56.0 + 12.0° / 58.0 + 28.0°
 Efficiency 88 %
 Peak intensity 3.5 cd/lm
 LEDs/each optic 1
 Light colour/type White
 Required components:

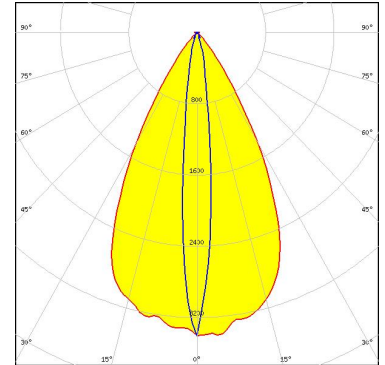

Light distribution files

SEMI
SEOUL SEMICONDUCTOR

LED Z8Y22T
 FWHM / FWTM 54.0 + 16.0° / 82.0 + 35.0°
 Efficiency 89 %
 Peak intensity 2.6 cd/lm
 LEDs/each optic 1
 Light colour/type White
 Required components:

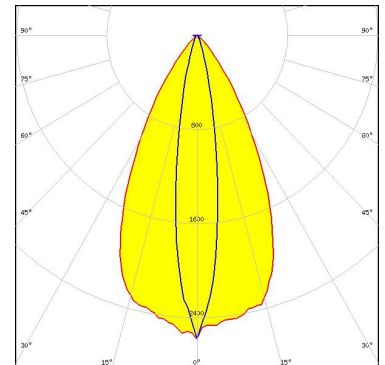

Light distribution files

GENERAL INFORMATION:

NOTE: The typical beam angle will be changed by different color, chip size and chip position tolerance. The typical total beam angle is the full angle measured where the luminous intensity is half of the peak value.

MATERIALS:

As part of our continuous research and improvement processes, and to ensure the best possible quality and availability of our products, LEDiL reserves the right to change material grades without notice.

PRODUCT DATA USER AGREEMENT AND DISCLAIMER:

The measured data in the provided downloadable LEDiL Product Datasheets and Mechanical 2D-Drawings is rounded and provided as reference for planning. LEDiL Oy's optical specifications have been verified by conducting performance testing of the products in accordance with the company's quality system. The reported data are averaged results of multiple measurements with typical variation. LEDiL Oy reserves the right to without prior notification make changes and improvements to its products.

LEDiL Oy assumes neither warranty, nor guarantee nor any other liability of any kind for the contents and correctness of the provided data. The provided data has been generated with highest diligence but the provided data may in reality not represent the complete possible variation range of all intrinsic parameters. Therefore, in certain cases a deviation from the provided data could occur.

LEDiL Oy reserves the right to undertake technical changes of its products without further notification which could lead to changes in the provided data. LEDiL Oy assumes no liability of any kind for the possible deviation from any provided data or any other damage resulting from the usage of the provided data.

The user agrees to this disclaimer and user agreement with the download or usage of the provided files.

LEDiL Oy

Joensuunkatu 13
FI-24240 SALO
Finland

LEDiL Inc.

228 West Page Street
Suite D
Sycamore IL 60178
USA

Ledil Optics Technology (Shenzhen) Co., Ltd.

405 , Block B
Casic Motor Building
Shenzhen 518057
P.R.CHINA

Local sales and technical support

[www.ledil.com/
where_to_buy](http://www.ledil.com/where_to_buy)

Shipping locations

Poznan, Poland
Hong Kong, China

Distribution Partners

[www.ledil.com/
where_to_buy](http://www.ledil.com/where_to_buy)