

EVA-WW

~55° wide beam

SPECIFICATION:

Dimensions	Ø 35.0 mm
Height	16.4 mm
Fastening	glue
ROHS compliant	yes ⓘ

MATERIALS:

Component	Type	Material	Colour	Finish	Length
EVA-WW	Single lens	PMMA	clear		35.0

ORDERING INFORMATION:

Component	Qty in box	MOQ	MPQ	Box weight (kg)
C10909_EVA-WW » Box size: 480 x 280 x 300 mm	540	90	45	6.0



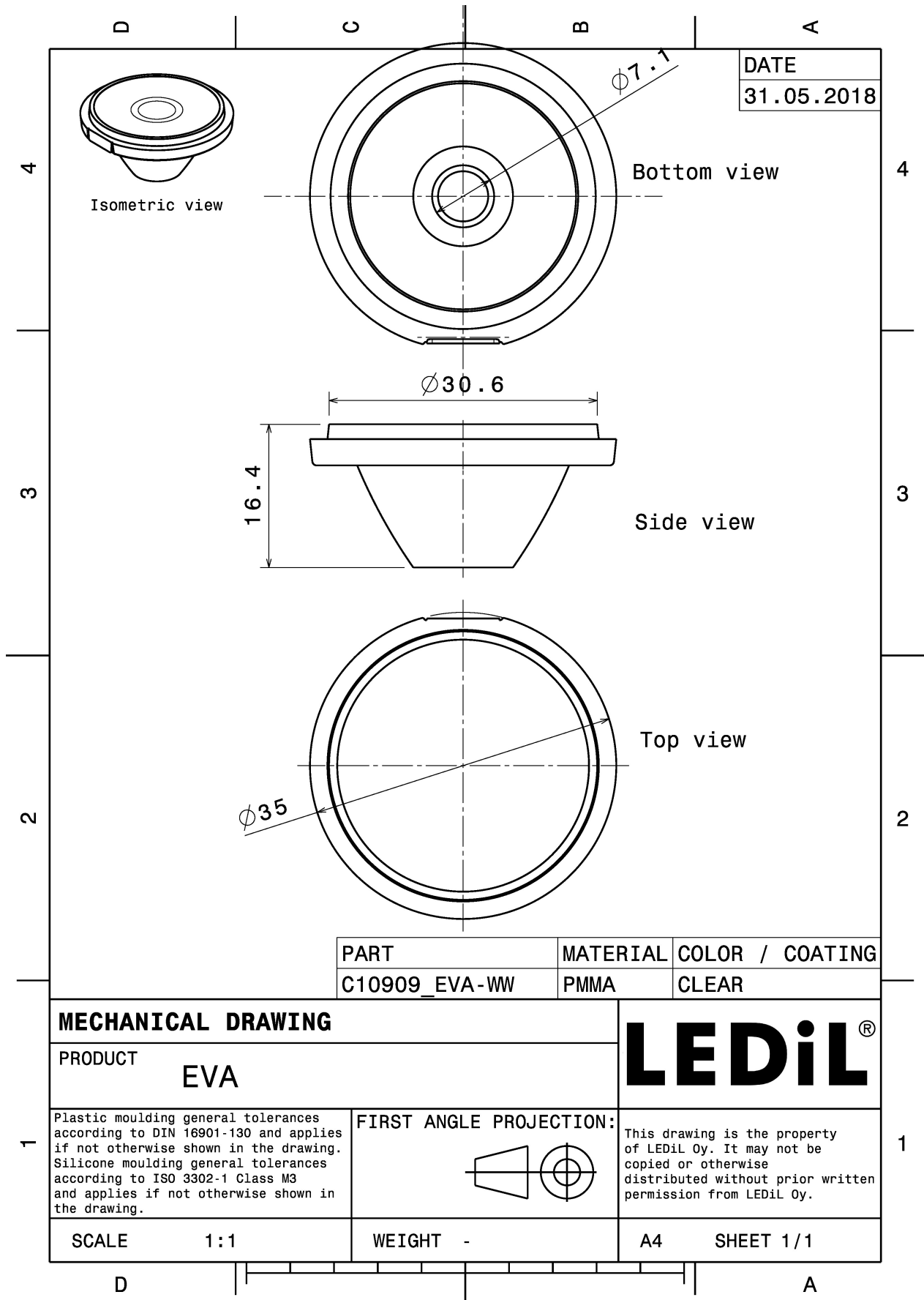

See also our general installation guide: www.ledil.com/installation_guide

OPTICAL RESULTS (MEASURED):

CITIZEN

LED CLU7A2/7A3
FWHM / FWTM 48.0° / 80.0°
Efficiency 81 %
Peak intensity 1.1 cd/lm
LEDs/each optic 1
Light colour/type White
Required components:

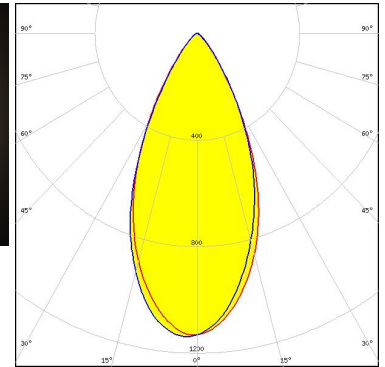
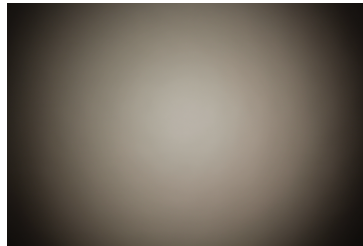

Light distribution files



LED MC-E
FWHM / FWTM 47.0°
Efficiency 90 %
Peak intensity 1 cd/lm
LEDs/each optic 1
Light colour/type White
Required components:

Light distribution files



LED MHB-A/B
FWHM / FWTM 52.0° / 84.0°
Efficiency 76 %
Peak intensity 1 cd/lm
LEDs/each optic 1
Light colour/type White
Required components:

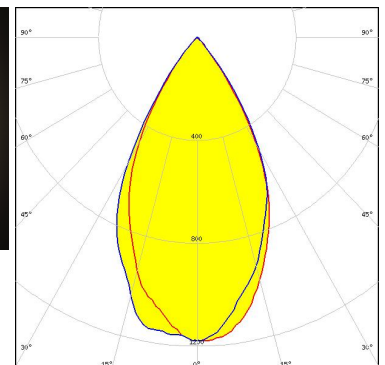
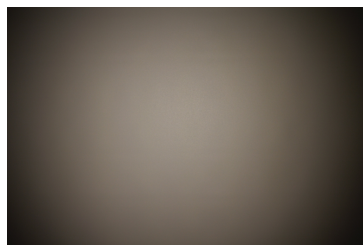

Light distribution files

OPTICAL RESULTS (MEASURED):



LED XHP35 HI
FWHM / FWTM 71.0° / 106.0°
Efficiency 75 %
Peak intensity 0.6 cd/lm
LEDs/each optic 1
Light colour/type White
Required components:



[Light distribution files](#)



LED XM-L
FWHM / FWTM 64.0°
Efficiency 77 %
LEDs/each optic 1
Light colour/type White
Required components:

[Light distribution files](#)



LED XT-E
FWHM / FWTM 47.0° / 83.0°
Efficiency 76 %
Peak intensity 1.1 cd/lm
LEDs/each optic 1
Light colour/type White
Required components:

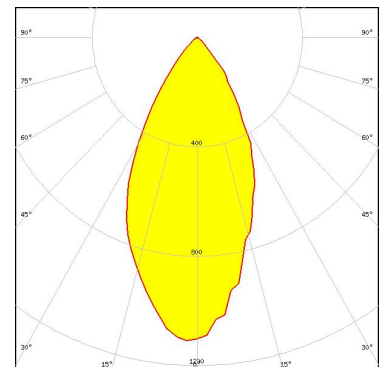

[Light distribution files](#)

OPTICAL RESULTS (MEASURED):



LED LUXEON 5050 Round LES
 FWHM / FWTM 57.0° / 85.0°
 Efficiency 78 %
 Peak intensity 1 cd/lm
 LEDs/each optic 1
 Light colour/type White
 Required components:

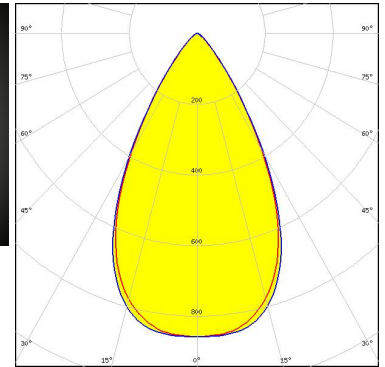
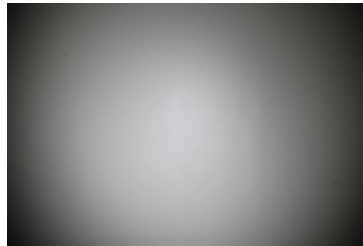

Light distribution files



LED LUXEON M/MX
 FWHM / FWTM 65.0°
 Efficiency 80 %
 LEDs/each optic 1
 Light colour/type White
 Required components:

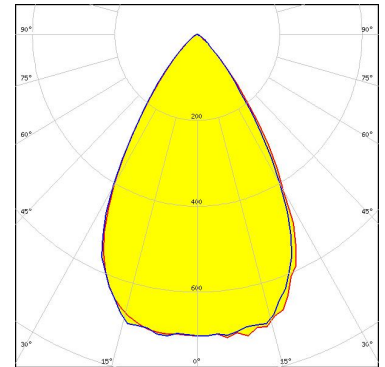

Light distribution files



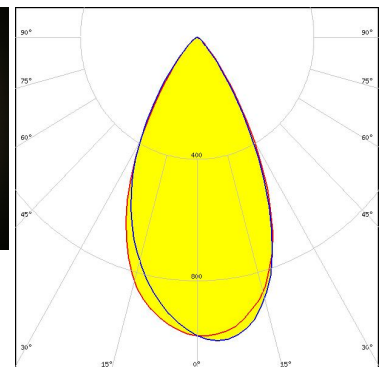
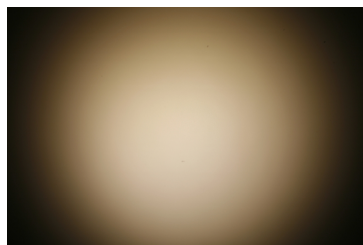

LED Duris S8
 FWHM / FWTM 55.0° / 84.0°
 Efficiency 79 %
 Peak intensity 1 cd/lm
 LEDs/each optic 1
 Light colour/type White
 Required components:

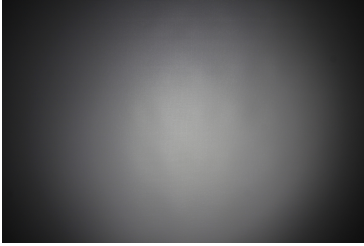

Light distribution files

OPTICAL RESULTS (MEASURED):

 SEOL SEMICONDUCTOR		
LED	Z8Y15	
FWHM / FWTM	45.0° / 82.0°	
Efficiency	77 %	
Peak intensity	1.3 cd/lm	
LEDs/each optic	1	
Light colour/type	White	
Required components:		
		<p>Light distribution files</p>

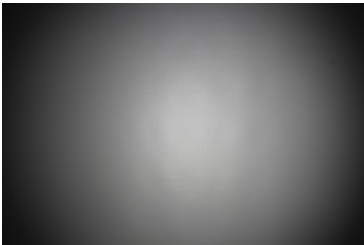
 SEOL SEMICONDUCTOR		
LED	Z8Y19	
FWHM / FWTM	47.0° / 82.0°	
Efficiency	76 %	
Peak intensity	1.2 cd/lm	
LEDs/each optic	1	
Light colour/type	White	
Required components:		
		<p>Light distribution files</p>

OPTICAL RESULTS (SIMULATED):



LED CXA/B 13xx
FWHM / FWTM 64.0° / 88.0°
Efficiency 92 %
Peak intensity 0.9 cd/lm
LEDs/each optic 1
Light colour/type White
Required components:

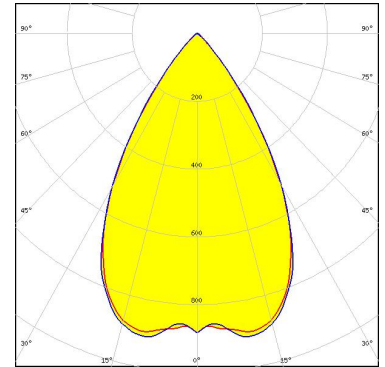

Light distribution files



LED XM-L HVW
FWHM / FWTM 58.0°
Efficiency %
LEDs/each optic 1
Light colour/type White
Required components:

Light distribution files



LED XP-G2
FWHM / FWTM 57.0° / 84.0°
Efficiency 90 %
Peak intensity 1.1 cd/lm
LEDs/each optic 1
Light colour/type White
Required components:

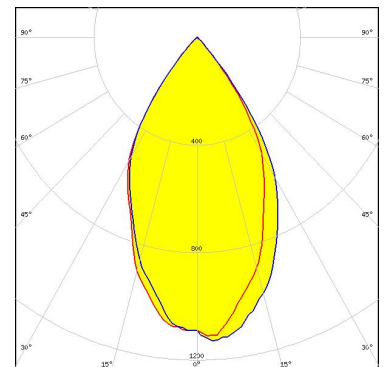

Light distribution files

OPTICAL RESULTS (SIMULATED):



LED LUXEON 5258
FWHM / FWTM 50.0° / 72.0°
Efficiency 93 %
Peak intensity 1.3 cd/lm
LEDs/each optic 1
Light colour/type White
Required components:

[Light distribution files](#)



LED LUXEON 7070
FWHM / FWTM 54.0° / 83.0°
Efficiency 96 %
Peak intensity 1.2 cd/lm
LEDs/each optic 1
Light colour/type White
Required components:

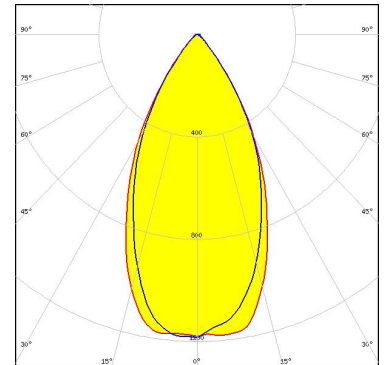

[Light distribution files](#)



LED CXM-3
FWHM / FWTM 49.0° / 78.0°
Efficiency 95 %
Peak intensity 1.4 cd/lm
LEDs/each optic 1
Light colour/type White
Required components:

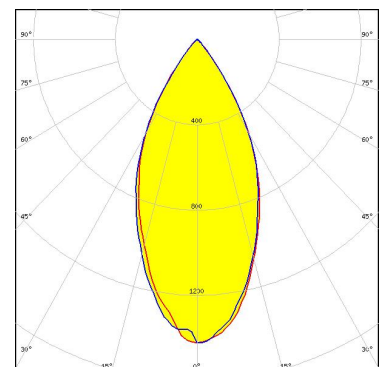

[Light distribution files](#)

OPTICAL RESULTS (SIMULATED):



LED CXM-4
FWHM / FWTM 50.0° / 78.0°
Efficiency 95 %
Peak intensity 1.4 cd/lm
LEDs/each optic 1
Light colour/type White
Required components:

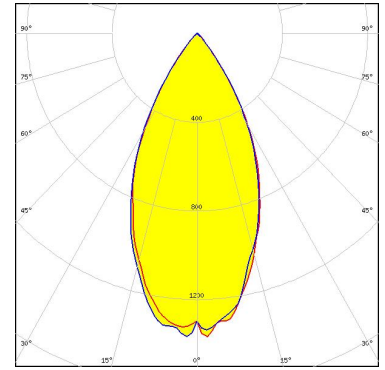

Light distribution files



LED NFMW48xA
FWHM / FWTM 70.0° / 89.0°
Efficiency 96 %
Peak intensity 0.8 cd/lm
LEDs/each optic 1
Light colour/type White
Required components:

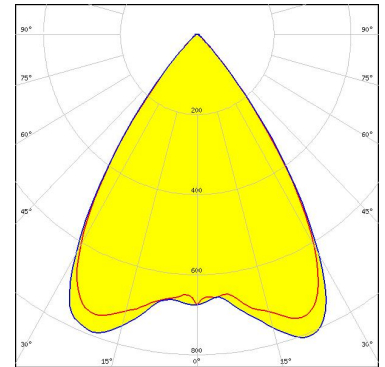

Light distribution files



LED OSCONIQ P 7070
FWHM / FWTM 56.0° / 78.0°
Efficiency 93 %
Peak intensity 1.2 cd/lm
LEDs/each optic 1
Light colour/type White
Required components:

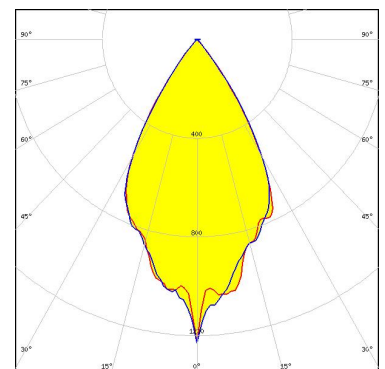

Light distribution files

GENERAL INFORMATION:

NOTE: The typical beam angle will be changed by different color, chip size and chip position tolerance. The typical total beam angle is the full angle measured where the luminous intensity is half of the peak value.

Due to use of high power COB's with this product, special attention to proper thermal design is highly recommended. LEDiL has no liability for direct, indirect or consecutive damages arising from the LEDiL products being used outside of the recommended temperature range.

MATERIALS:

As part of our continuous research and improvement processes, and to ensure the best possible quality and availability of our products, LEDiL reserves the right to change material grades without notice.

PRODUCT DATA USER AGREEMENT AND DISCLAIMER:

The measured data in the provided downloadable LEDiL Product Datasheets and Mechanical 2D-Drawings is rounded and provided as reference for planning. LEDiL Oy's optical specifications have been verified by conducting performance testing of the products in accordance with the company's quality system. The reported data are averaged results of multiple measurements with typical variation. LEDiL Oy reserves the right to without prior notification make changes and improvements to its products.

LEDiL Oy assumes neither warranty, nor guarantee nor any other liability of any kind for the contents and correctness of the provided data. The provided data has been generated with highest diligence but the provided data may in reality not represent the complete possible variation range of all intrinsic parameters. Therefore, in certain cases a deviation from the provided data could occur.

LEDiL Oy reserves the right to undertake technical changes of its products without further notification which could lead to changes in the provided data. LEDiL Oy assumes no liability of any kind for the possible deviation from any provided data or any other damage resulting from the usage of the provided data.

The user agrees to this disclaimer and user agreement with the download or usage of the provided files.

LEDiL Oy

Joensuunkatu 13
FI-24240 SALO
Finland

LEDiL Inc.

228 West Page Street
Suite D
Sycamore IL 60178
USA

Ledil Optics Technology (Shenzhen) Co., Ltd.

405 , Block B
Casic Motor Building
Shenzhen 518057
P.R.CHINA

Local sales and technical support

[www.ledil.com/
where_to_buy](http://www.ledil.com/where_to_buy)

Shipping locations

Poznan, Poland
Hong Kong, China

Distribution Partners

[www.ledil.com/
where_to_buy](http://www.ledil.com/where_to_buy)