

STRADA-SQ-T2

IESNA Type II (medium) beam, applicable for European P-class standard pedestrian lighting and M-class roads. Version with location pins.

SPECIFICATION:

Dimensions	25.0 x 25.0 mm
Height	8.6 mm
Fastening	glue, pin, screw
ROHS compliant	yes ⓘ



MATERIALS:

Component	Type	Material	Colour	Finish	Length
STRADA-SQ-T2	Single lens	PMMA	clear		25.0

ORDERING INFORMATION:

Component	Qty in box	MOQ	MPQ	Box weight (kg)
C13508_STRADA-SQ-T2	2058	294	98	7.8
» Box size:				

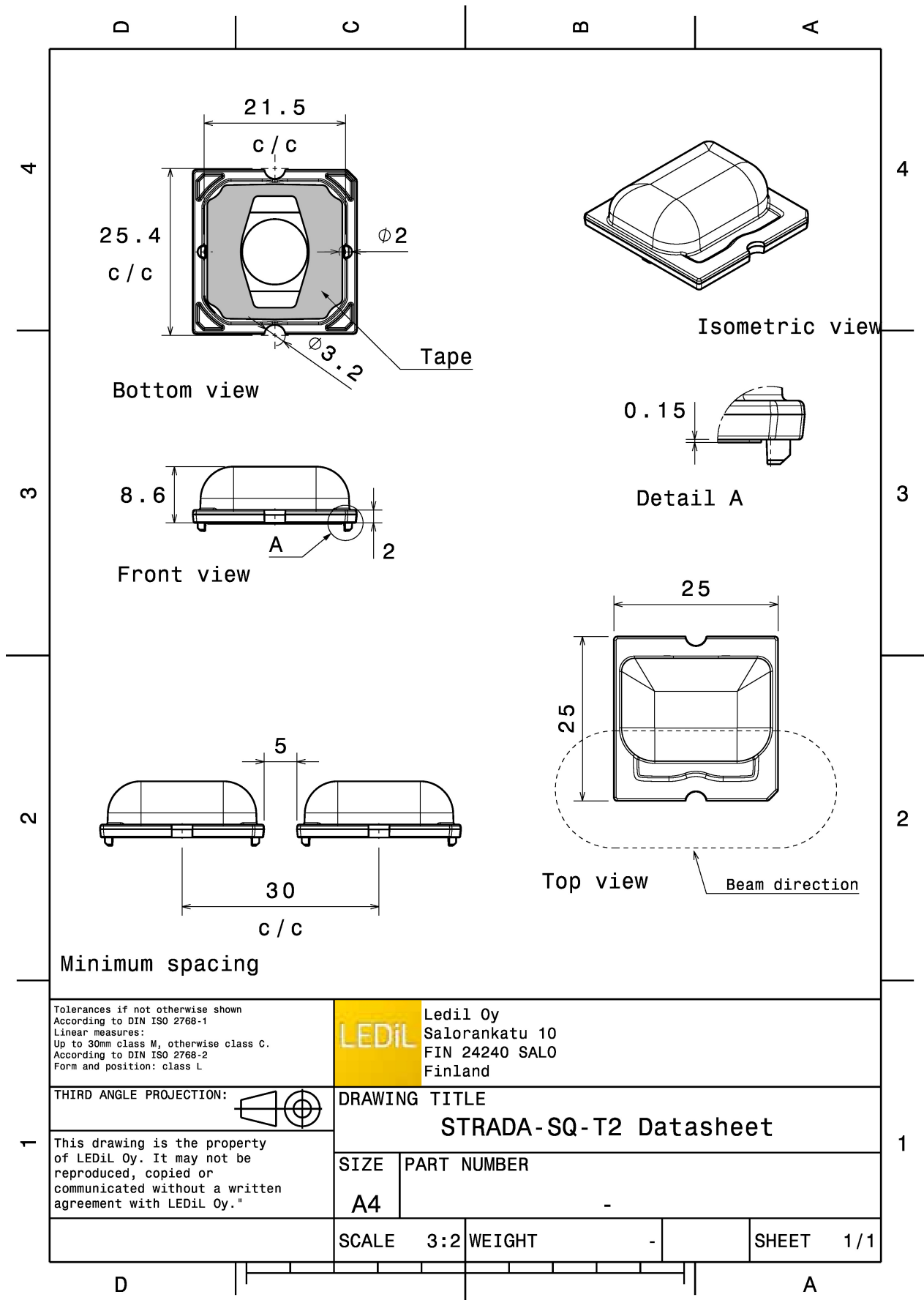

See also our general installation guide: www.ledil.com/installation_guide

OPTICAL RESULTS (MEASURED):



LED MK-R
FWHM / FWTM Asymmetric
Efficiency 94 %
Peak intensity 0.6 cd/lm
LEDs/each optic 1
Light colour/type White
Required components:

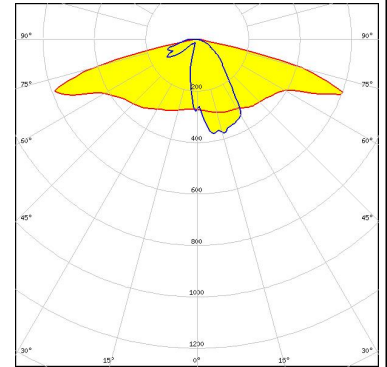

Light distribution files



LED XHP50
FWHM / FWTM Asymmetric
Efficiency 94 %
Peak intensity 0.7 cd/lm
LEDs/each optic 1
Light colour/type White
Required components:

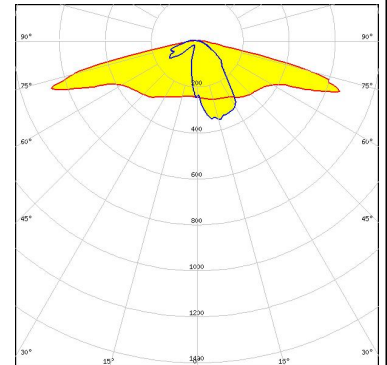

Light distribution files



LED LUXEON M/MX
FWHM / FWTM Asymmetric
Efficiency 93 %
Peak intensity 0.7 cd/lm
LEDs/each optic 1
Light colour/type White
Required components:

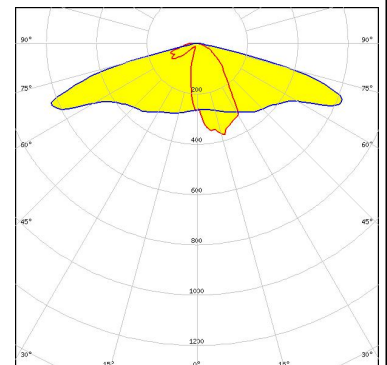

Light distribution files

OPTICAL RESULTS (MEASURED):



LED LUXEON MZ
FWHM / FWTM Asymmetric
Efficiency 94 %
Peak intensity 1.3 cd/lm
LEDs/each optic 1
Light colour/type White
Required components:

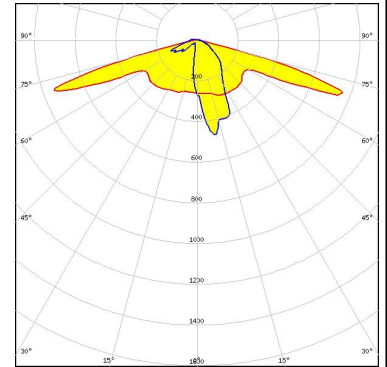

Light distribution files



LED NFMW48xA
FWHM / FWTM Asymmetric
Efficiency 94 %
Peak intensity 0.8 cd/lm
LEDs/each optic 1
Light colour/type White
Required components:

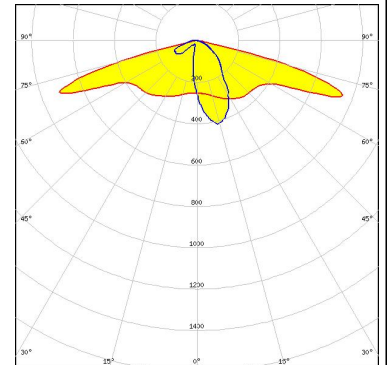

Light distribution files



LED NS9x383
FWHM / FWTM Asymmetric
Efficiency 94 %
Peak intensity 1.1 cd/lm
LEDs/each optic 1
Light colour/type White
Required components:

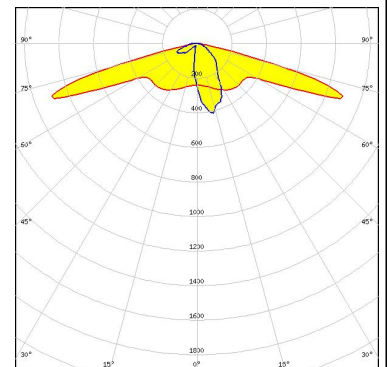

Light distribution files

OPTICAL RESULTS (SIMULATED):



LED MHB-A/B
FWHM / FWTM Asymmetric
Efficiency %
LEDs/each optic 1
Light colour/type White
Required components:

[Light distribution files](#)



LED XM-L2
FWHM / FWTM Asymmetric
Efficiency %
LEDs/each optic 1
Light colour/type White
Required components:

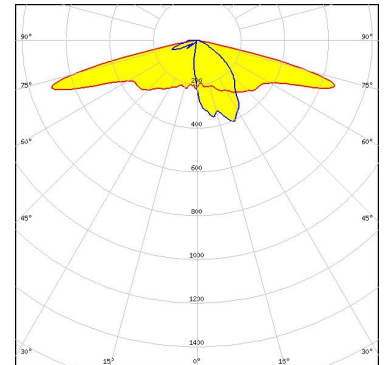

[Light distribution files](#)



LED LUXEON M/MX
FWHM / FWTM Asymmetric
Efficiency 81 %
Peak intensity 0.5 cd/lm
LEDs/each optic 1
Light colour/type White
Required components:

Protective plate, glass

[Light distribution files](#)

OPTICAL RESULTS (SIMULATED):

NICHIA

LED	NVSW519A
FWHM / FWTM	Asymmetric
Efficiency	93 %
Peak intensity	0.8 cd/lm
LEDs/each optic	1
Light colour/type	White
Required components:	

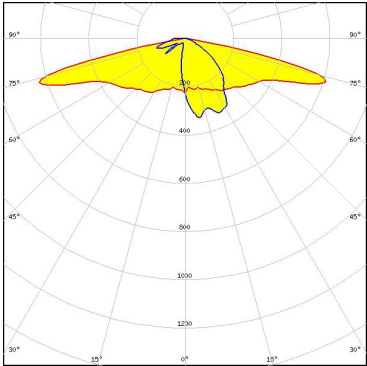

Light distribution files

The diagram shows a light distribution pattern on a polar coordinate system. The vertical axis represents the beam angle from 0° to 90°, and the horizontal axis represents the beam spread from 15° to 30°. The light distribution is shown as a yellow and orange area, indicating a beam spread of approximately 15° to 30° and a beam angle of approximately 75° to 85°.

OSRAM
Opto Semiconductors

LED	Duris S8
FWHM / FWTM	Asymmetric
Efficiency	92 %
LEDs/each optic	1
Light colour/type	White
Required components:	

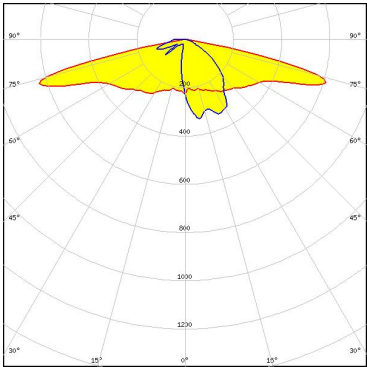

Light distribution files

The diagram shows a light distribution pattern on a polar coordinate system. The vertical axis represents the beam angle from 0° to 90°, and the horizontal axis represents the beam spread from 15° to 30°. The light distribution is shown as a yellow and orange area, indicating a beam spread of approximately 15° to 30° and a beam angle of approximately 75° to 85°.

SAMSUNG

LED	LH181B
FWHM / FWTM	Asymmetric
Efficiency	81 %
Peak intensity	0.5 cd/lm
LEDs/each optic	4
Light colour/type	White
Required components:	

Protective plate, glass

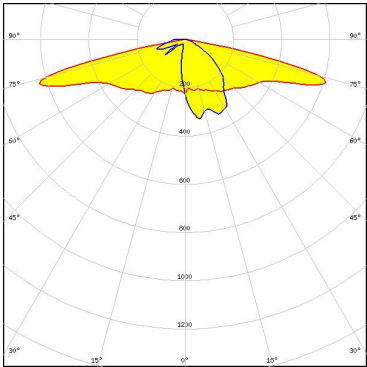

Light distribution files

The diagram shows a light distribution pattern on a polar coordinate system. The vertical axis represents the beam angle from 0° to 90°, and the horizontal axis represents the beam spread from 15° to 30°. The light distribution is shown as a yellow and orange area, indicating a beam spread of approximately 15° to 30° and a beam angle of approximately 75° to 85°.

OPTICAL RESULTS (SIMULATED):

SAMSUNG

LED LH181B
FWHM / FWTM Asymmetric
Efficiency 96 %
Peak intensity 1.1 cd/lm
LEDs/each optic 1
Light colour/type White
Required components:

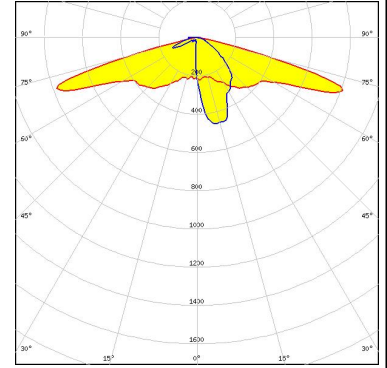

Light distribution files

SAMSUNG

LED LH351B
FWHM / FWTM Asymmetric
Efficiency 95 %
Peak intensity 0.8 cd/lm
LEDs/each optic 1
Light colour/type White
Required components:

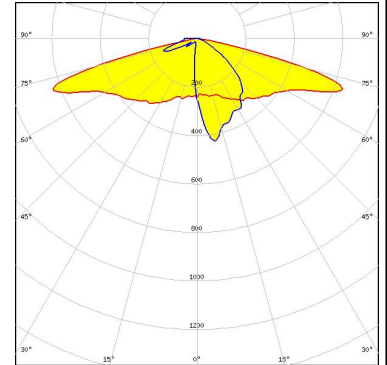

Light distribution files

GENERAL INFORMATION:

NOTE: The typical beam angle will be changed by different color, chip size and chip position tolerance. The typical total beam angle is the full angle measured where the luminous intensity is half of the peak value.

MATERIALS:

As part of our continuous research and improvement processes, and to ensure the best possible quality and availability of our products, LEDiL reserves the right to change material grades without notice.

PRODUCT DATA USER AGREEMENT AND DISCLAIMER:

The measured data in the provided downloadable LEDiL Product Datasheets and Mechanical 2D-Drawings is rounded and provided as reference for planning. LEDiL Oy's optical specifications have been verified by conducting performance testing of the products in accordance with the company's quality system. The reported data are averaged results of multiple measurements with typical variation. LEDiL Oy reserves the right to without prior notification make changes and improvements to its products.

LEDiL Oy assumes neither warranty, nor guarantee nor any other liability of any kind for the contents and correctness of the provided data. The provided data has been generated with highest diligence but the provided data may in reality not represent the complete possible variation range of all intrinsic parameters. Therefore, in certain cases a deviation from the provided data could occur.

LEDiL Oy reserves the right to undertake technical changes of its products without further notification which could lead to changes in the provided data. LEDiL Oy assumes no liability of any kind for the possible deviation from any provided data or any other damage resulting from the usage of the provided data.

The user agrees to this disclaimer and user agreement with the download or usage of the provided files.

LEDiL Oy

Joensuunkatu 13
FI-24240 SALO
Finland

LEDiL Inc.

228 West Page Street
Suite D
Sycamore IL 60178
USA

Ledil Optics Technology (Shenzhen) Co., Ltd.

405 , Block B
Casic Motor Building
Shenzhen 518057
P.R.CHINA

Local sales and technical support

[www.ledil.com/
where_to_buy](http://www.ledil.com/where_to_buy)

Shipping locations

Poznan, Poland
Hong Kong, China

Distribution Partners

[www.ledil.com/
where_to_buy](http://www.ledil.com/where_to_buy)