

## VERONICA-SQ-M

~30° medium beam

### SPECIFICATION:

Dimensions	22.5 x 22.5
Height	11.8 mm
Fastening	tape, pin
ROHS compliant	yes ⓘ

### MATERIALS:

Component	Type	Material	Colour	Finish	Length (mm)
VERONICA-SQ-M	Single lens	PMMA	clear		
VERONICA-TAPE	Tape	Acrylic foam	clear		

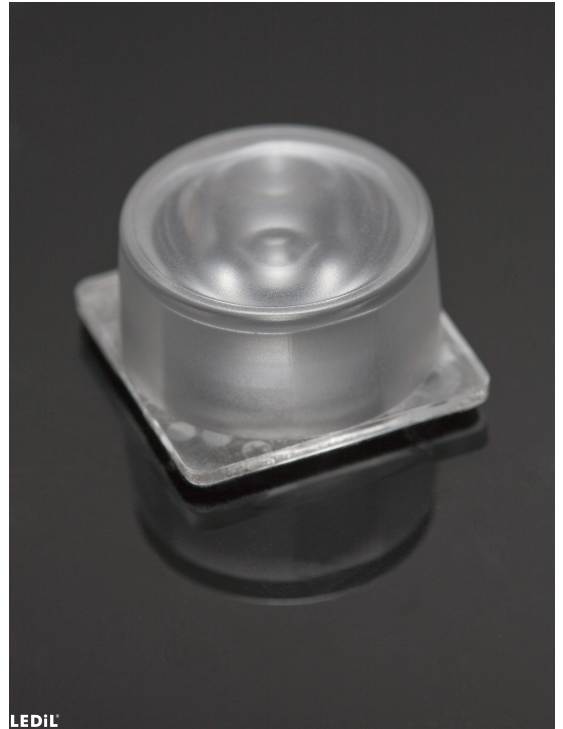

### ORDERING INFORMATION:

Component		Qty in box	MOQ	MPQ	Box weight (kg)
CA14461_VERONICA-SQ-M	Single lens	1980	360	180	8.2
» Box size: 476 x 273 x 197 mm					

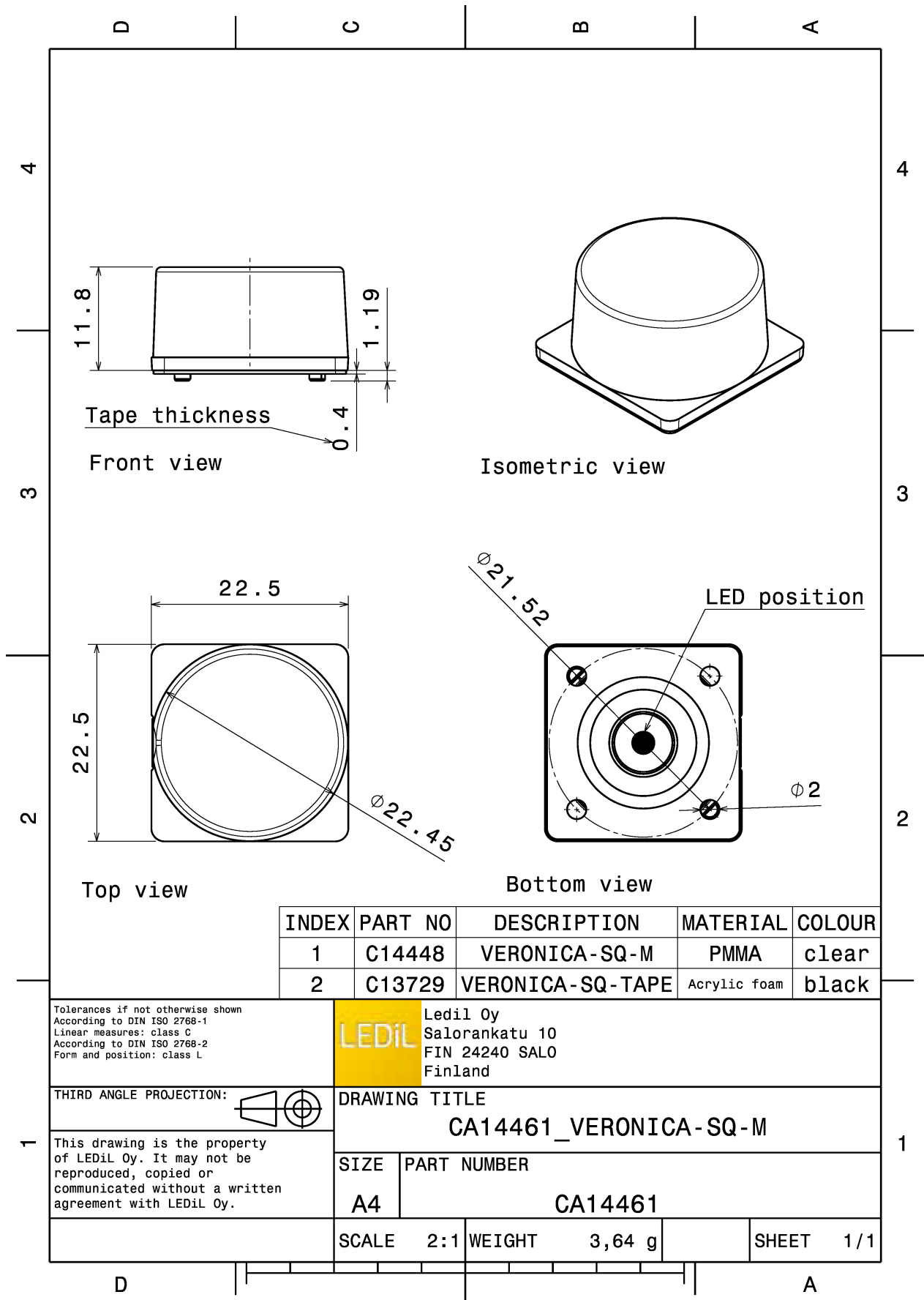

See also our general installation guide: [www.ledil.com/installation\\_guide](http://www.ledil.com/installation_guide)

### OPTICAL RESULTS (MEASURED):



LED XB-H  
FWHM / FWTM 29.0° / 52.0°  
Efficiency 91 %  
Peak intensity 3 cd/m  
LEDs/each optic 1  
Light colour/type White  
Required components:

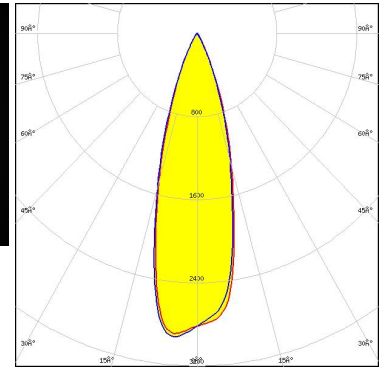
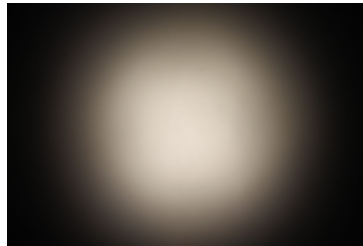

Light distribution files



LED XHP35 HD  
FWHM / FWTM 40.0° / 64.0°  
Efficiency 88 %  
Peak intensity 1.9 cd/m  
LEDs/each optic 1  
Light colour/type White  
Required components:

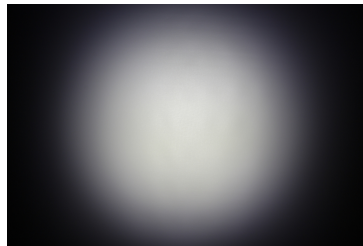

Light distribution files



LED XHP35 HI  
FWHM / FWTM 33.0° / 54.0°  
Efficiency 88 %  
Peak intensity 2.7 cd/m  
LEDs/each optic 1  
Light colour/type White  
Required components:

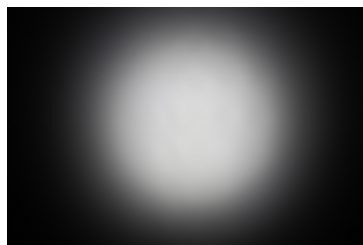

Light distribution files

#### OPTICAL RESULTS (MEASURED):



LED XM-L  
 FWHM / FWTM 37.0° / 59.0°  
 Efficiency 92 %  
 Peak intensity 2.1 cd/lm  
 LEDs/each optic 1  
 Light colour/type White  
 Required components:

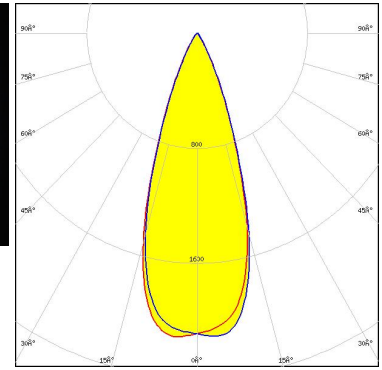
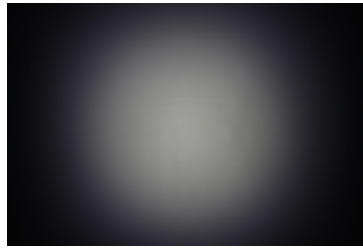

Light distribution files



LED XM-L2  
 FWHM / FWTM 38.0° / 60.0°  
 Efficiency 91 %  
 Peak intensity 2.1 cd/lm  
 LEDs/each optic 1  
 Light colour/type White  
 Required components:

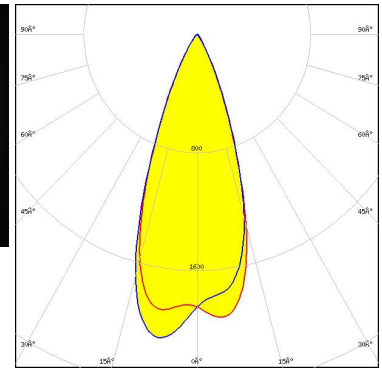
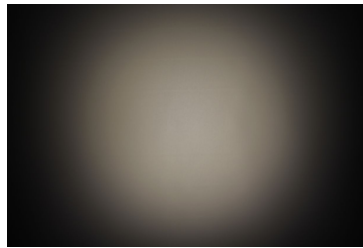

Light distribution files



LED XM-L3  
 FWHM / FWTM 37.0° / 58.0°  
 Efficiency 95 %  
 Peak intensity 2.2 cd/lm  
 LEDs/each optic 1  
 Light colour/type White  
 Required components:

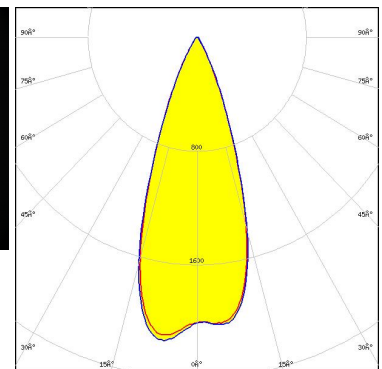
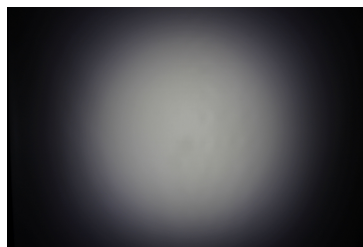

Light distribution files



#### OPTICAL RESULTS (MEASURED):



LED XP-E  
 FWHM / FWTM 28.0° / 47.0°  
 Efficiency 93 %  
 Peak intensity 3.6 cd/lm  
 LEDs/each optic 1  
 Light colour/type White  
 Required components:

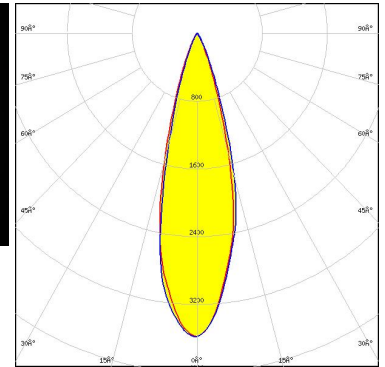
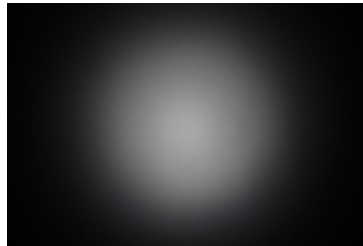

Light distribution files



LED XP-E2  
 FWHM / FWTM 25.0° / 45.0°  
 Efficiency 94 %  
 Peak intensity 4.2 cd/lm  
 LEDs/each optic 1  
 Light colour/type White  
 Required components:

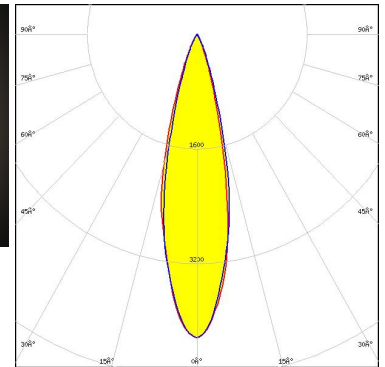
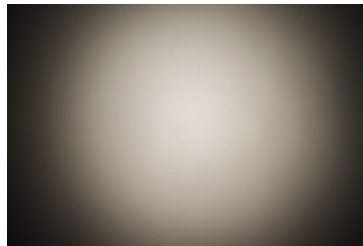

Light distribution files



LED XP-G2  
 FWHM / FWTM 30.0° / 52.0°  
 Efficiency 89 %  
 Peak intensity 3.1 cd/lm  
 LEDs/each optic 1  
 Light colour/type White  
 Required components:

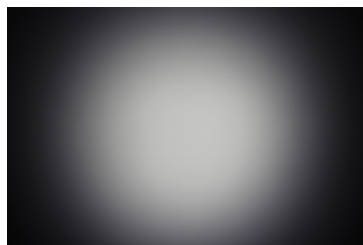

Light distribution files

#### OPTICAL RESULTS (MEASURED):



LED XP-L HD  
 FWHM / FWTM 40.0° / 61.0°  
 Efficiency 91 %  
 Peak intensity 2 cd/lm  
 LEDs/each optic 1  
 Light colour/type White  
 Required components:

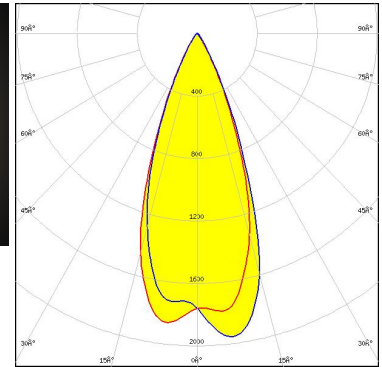
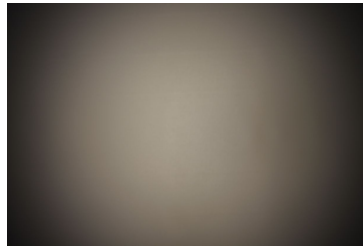

Light distribution files



LED XP-L2  
 FWHM / FWTM 37.0° / 60.0°  
 Efficiency 87 %  
 Peak intensity 2 cd/lm  
 LEDs/each optic 1  
 Light colour/type White  
 Required components:

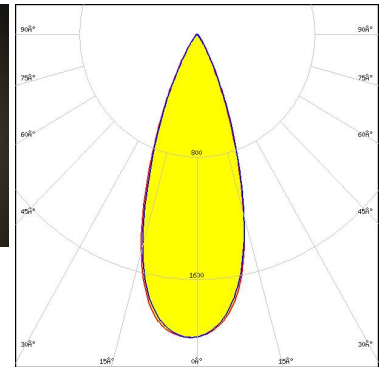
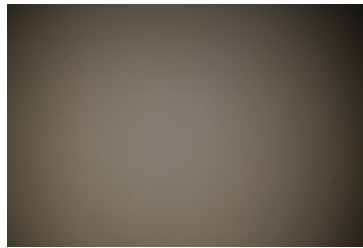

Light distribution files



LED XT-E  
 FWHM / FWTM 27.0° / 50.0°  
 Efficiency 87 %  
 Peak intensity 3.5 cd/lm  
 LEDs/each optic 1  
 Light colour/type White  
 Required components:

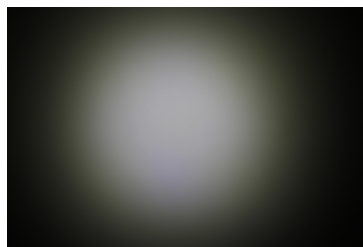

Light distribution files

#### OPTICAL RESULTS (MEASURED):



LED LUXEON 3030 2D (Round LES)  
 FWHM / FWTM 24.0° / 44.0°  
 Efficiency 94 %  
 Peak intensity 4.5 cd/lm  
 LEDs/each optic 1  
 Light colour/type White  
 Required components:

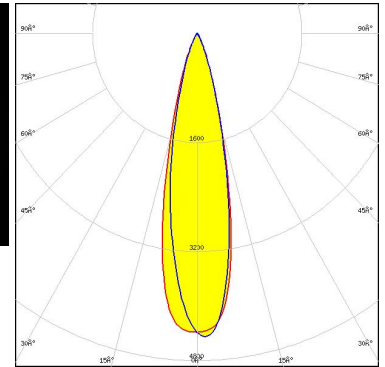

Light distribution files



LED LUXEON A  
 FWHM / FWTM 30.0° / 52.0°  
 Efficiency 91 %  
 Peak intensity 3 cd/lm  
 LEDs/each optic 1  
 Light colour/type White  
 Required components:

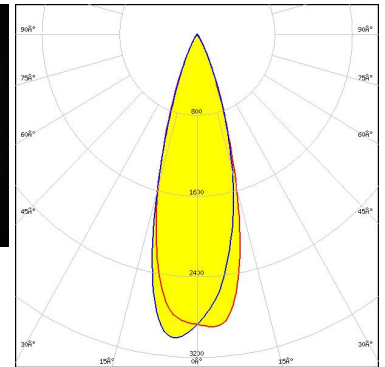
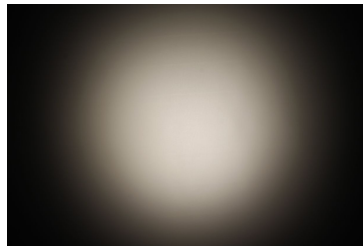

Light distribution files



LED LUXEON MZ  
 FWHM / FWTM 32.0° / 52.0°  
 Efficiency 93 %  
 Peak intensity 2.7 cd/lm  
 LEDs/each optic 1  
 Light colour/type White  
 Required components:

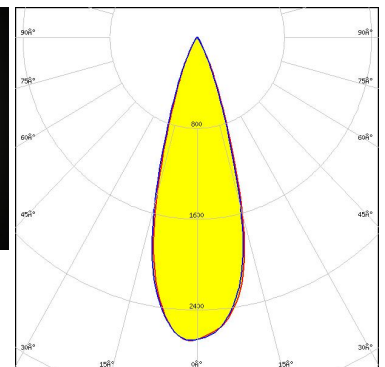
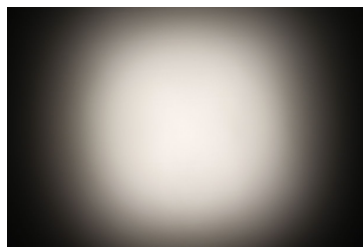

Light distribution files

#### OPTICAL RESULTS (MEASURED):



LED LUXEON R  
 FWHM / FWTM 30.0° / 51.0°  
 Efficiency 91 %  
 Peak intensity 3 cd/m  
 LEDs/each optic 1  
 Light colour/type White  
 Required components:

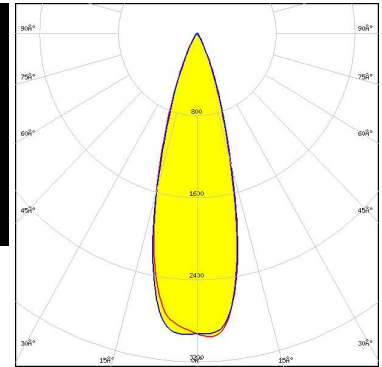
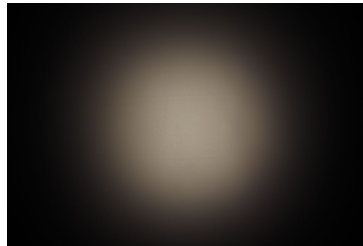

Light distribution files



LED LUXEON Rebel  
 FWHM / FWTM 26.0° / 47.0°  
 Efficiency 92 %  
 Peak intensity 3.6 cd/m  
 LEDs/each optic 1  
 Light colour/type White  
 Required components:

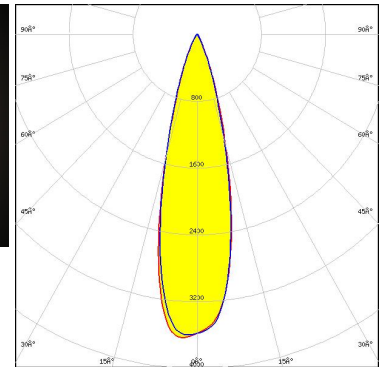
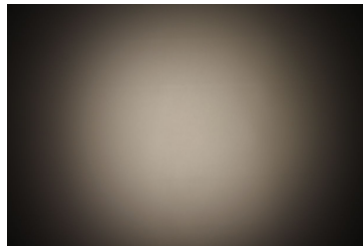

Light distribution files



LED LUXEON Rebel ES  
 FWHM / FWTM 27.0° / 48.0°  
 Efficiency 91 %  
 Peak intensity 3.5 cd/m  
 LEDs/each optic 1  
 Light colour/type White  
 Required components:

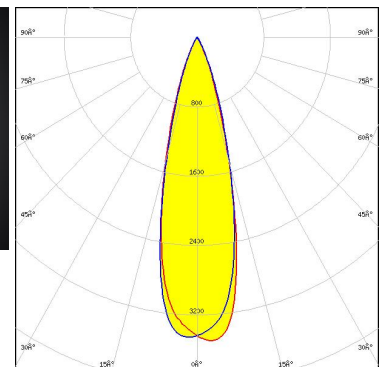
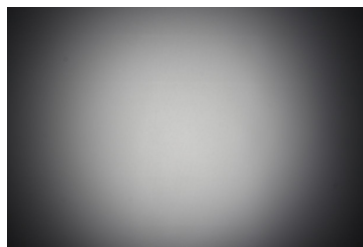

Light distribution files

### OPTICAL RESULTS (MEASURED):



LED LUXEON T  
FWHM / FWTM 30.0° / 51.0°  
Efficiency 93 %  
Peak intensity 3 cd/lm  
LEDs/each optic 1  
Light colour/type White  
Required components:

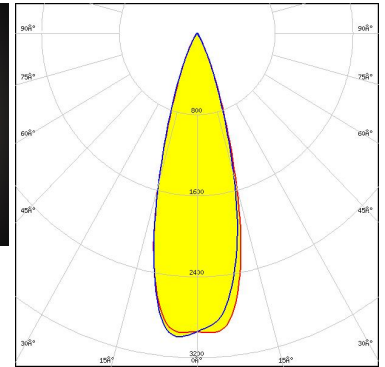
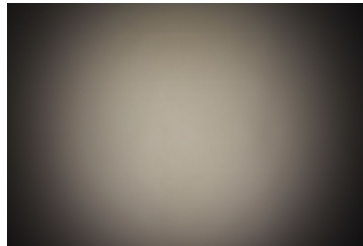

Light distribution files



LED LUXEON TX  
FWHM / FWTM 30.0° / 50.0°  
Efficiency 92 %  
Peak intensity 3.2 cd/lm  
LEDs/each optic 1  
Light colour/type White  
Required components:

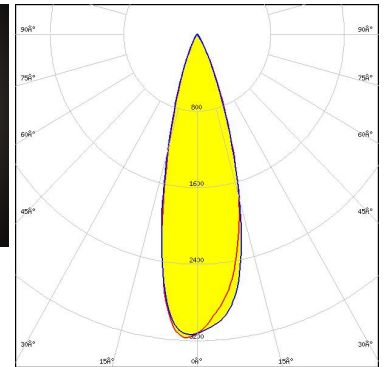
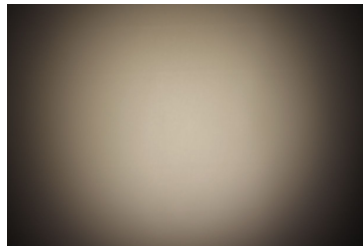

Light distribution files



LED LUXEON V  
FWHM / FWTM 35.0° / 58.0°  
Efficiency 90 %  
Peak intensity 2.3 cd/lm  
LEDs/each optic 1  
Light colour/type White  
Required components:

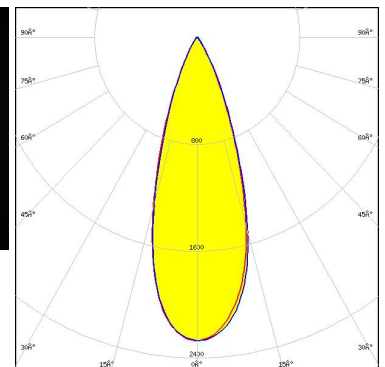
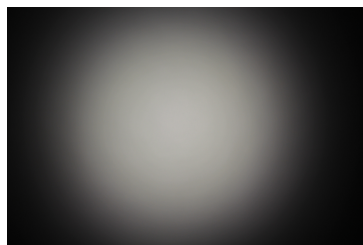

Light distribution files

#### OPTICAL RESULTS (MEASURED):



**LED** LUXEON V2  
**FWHM / FWTM** 29.0° / 51.0°  
**Efficiency** 94 %  
**Peak intensity** 3.2 cd/lm  
**LEDs/each optic** 1  
**Light colour/type** White  
**Required components:**

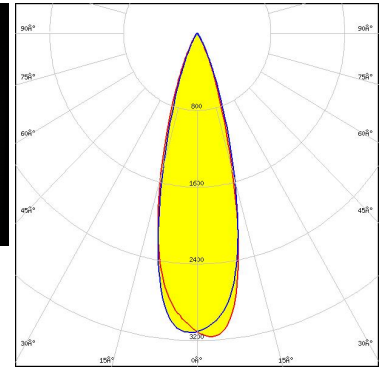
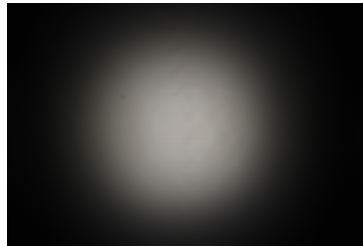

Light distribution files



**LED** NCSxx19B  
**FWHM / FWTM** 23.0° / 44.0°  
**Efficiency** 92 %  
**Peak intensity** 4.1 cd/lm  
**LEDs/each optic** 1  
**Light colour/type** White  
**Required components:**

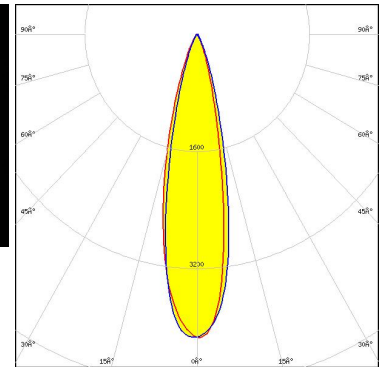

Light distribution files



**LED** NVSW219F  
**FWHM / FWTM** 35.0° / 56.0°  
**Efficiency** 94 %  
**Peak intensity** 2.5 cd/lm  
**LEDs/each optic** 1  
**Light colour/type** White  
**Required components:**

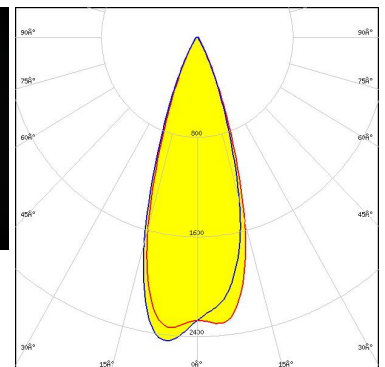
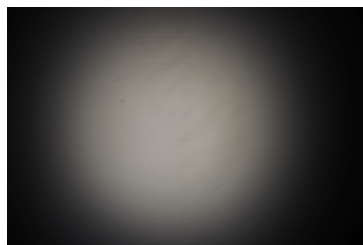

Light distribution files

#### OPTICAL RESULTS (MEASURED):



LED NVSxx19B/NVSxx19C  
 FWHM / FWTM 30.0° / 51.0°  
 Efficiency 91 %  
 Peak intensity 2.9 cd/lm  
 LEDs/each optic 1  
 Light colour/type White  
 Required components:

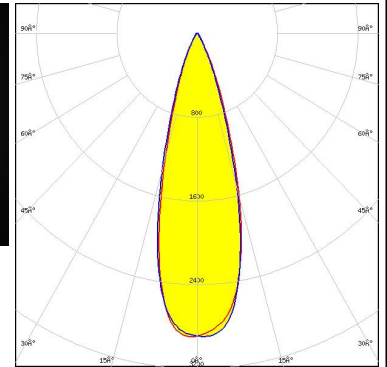

Light distribution files



LED NWSx229A  
 FWHM / FWTM 39.0° / 59.0°  
 Efficiency 89 %  
 Peak intensity 2 cd/lm  
 LEDs/each optic 1  
 Light colour/type White  
 Required components:

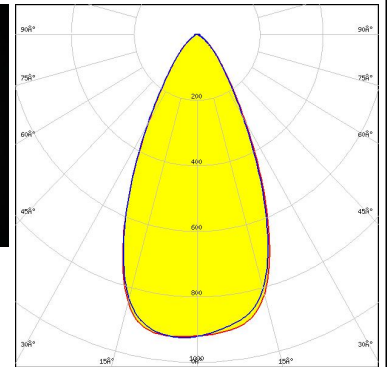
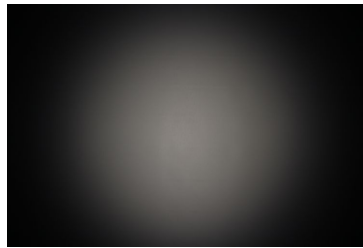

Light distribution files



LED OSLOM Square EC  
 FWHM / FWTM 28.0° / 50.0°  
 Efficiency 91 %  
 Peak intensity 3.4 cd/lm  
 LEDs/each optic 1  
 Light colour/type White  
 Required components:

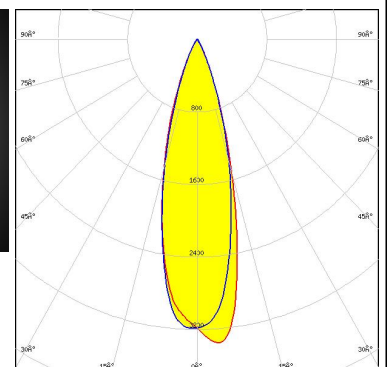
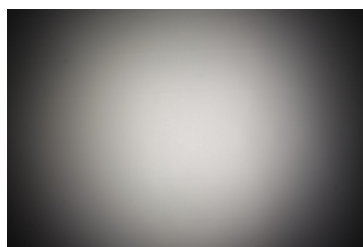

Light distribution files



#### OPTICAL RESULTS (MEASURED):

**OSRAM**  
Opto Semiconductors

LED OSLON Square PC  
 FWHM / FWTM 29.0° / 51.0°  
 Efficiency 91 %  
 Peak intensity 3 cd/lm  
 LEDs/each optic 1  
 Light colour/type White  
 Required components:

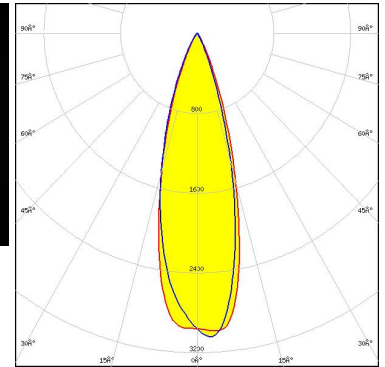
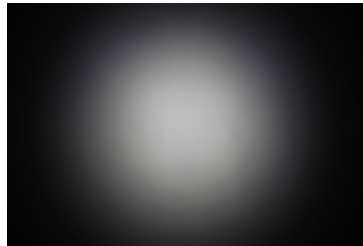

Light distribution files

**SAMSUNG**

LED LH181A  
 FWHM / FWTM 21.0° / 42.0°  
 Efficiency 94 %  
 Peak intensity 4.3 cd/lm  
 LEDs/each optic 1  
 Light colour/type White  
 Required components:

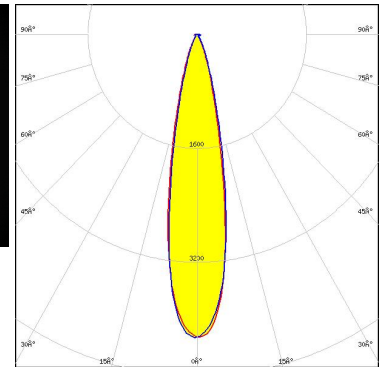
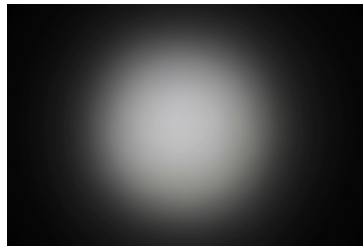

Light distribution files

**SAMSUNG**

LED LH181B  
 FWHM / FWTM 23.0° / 42.0°  
 Efficiency 94 %  
 Peak intensity 4.5 cd/lm  
 LEDs/each optic 1  
 Light colour/type White  
 Required components:

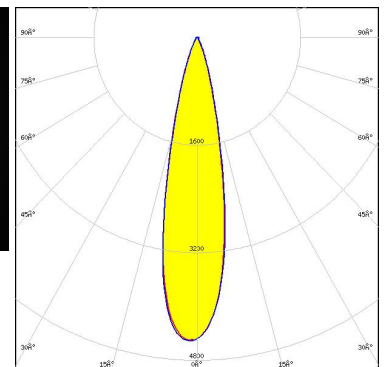
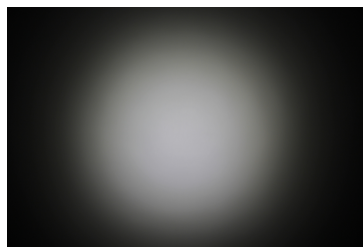

Light distribution files

#### OPTICAL RESULTS (MEASURED):

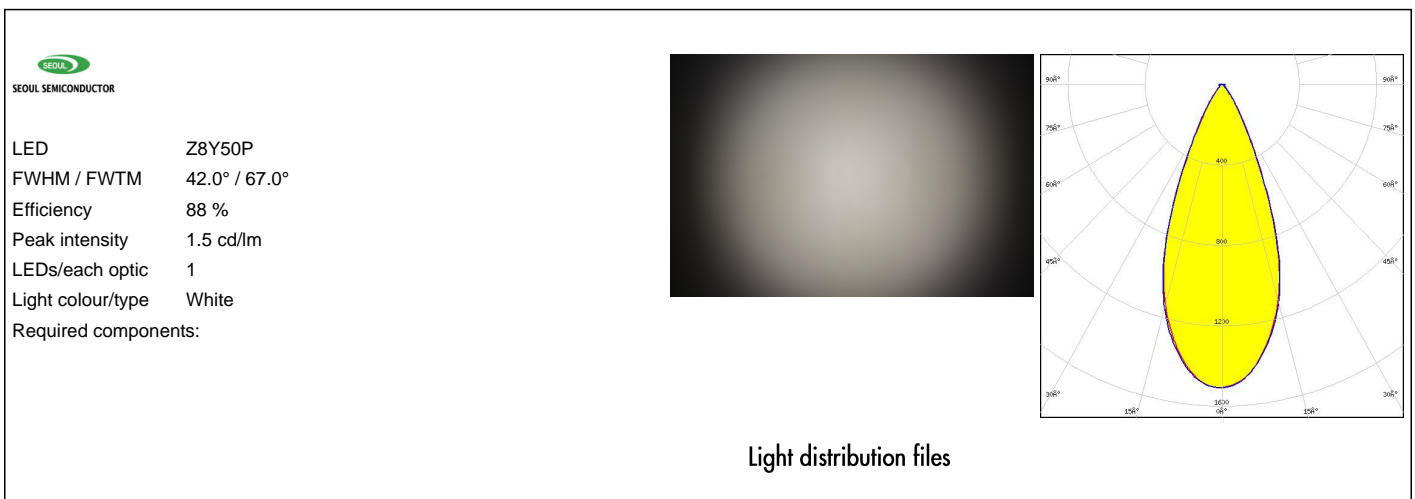
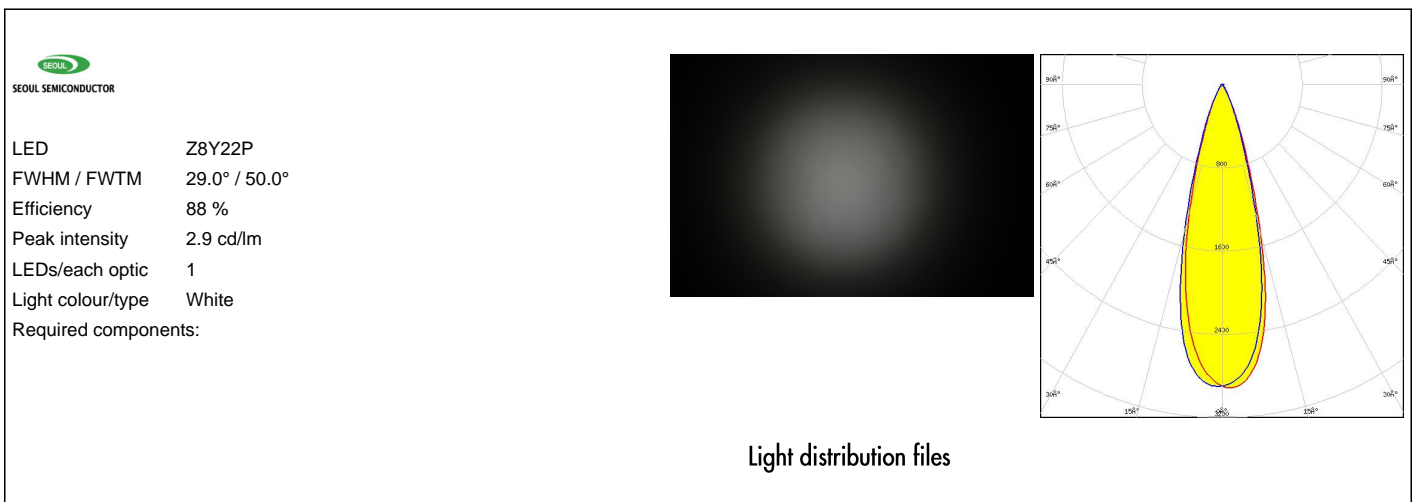
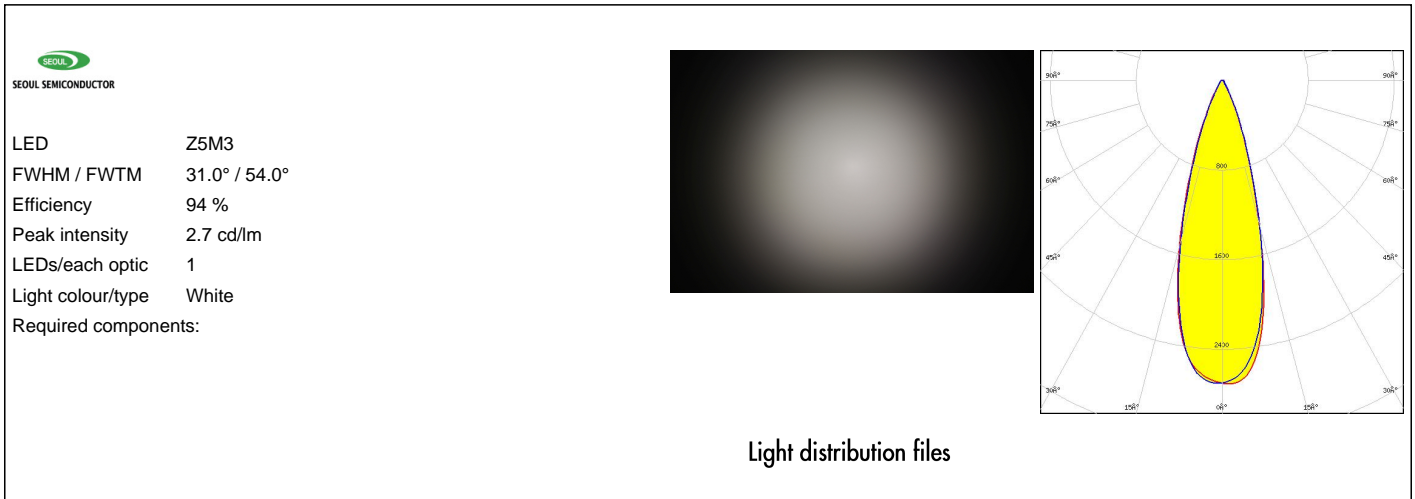

### OPTICAL RESULTS (SIMULATED):



LED XHP35.2 HD  
FWHM / FWTM 30.0° / 52.0°  
Efficiency 95 %  
Peak intensity 3 cd/lm  
LEDs/each optic 1  
Light colour/type White  
Required components:

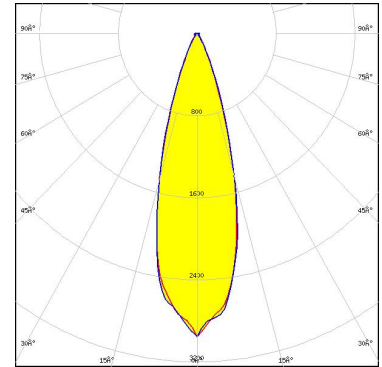

Light distribution files



LED XP-G4 HI  
FWHM / FWTM 30.0° / 48.0° + 49.0°  
Efficiency 97 %  
Peak intensity 3.5 cd/lm  
LEDs/each optic 1  
Light colour/type White  
Required components:

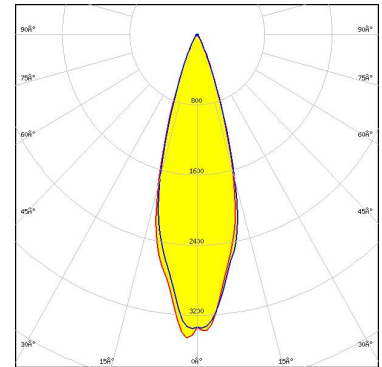

Light distribution files



LED LUXEON C  
FWHM / FWTM 29.0° / 47.0°  
Efficiency 94 %  
Peak intensity 3.7 cd/lm  
LEDs/each optic 1  
Light colour/type White  
Required components:

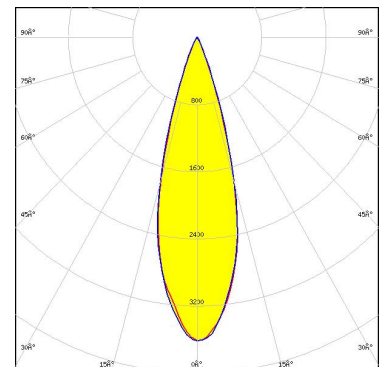

Light distribution files

### OPTICAL RESULTS (SIMULATED):



LED SFT-40 Gen2  
FWHM / FWTM 36.0 + 37.0° / 56.0 + 55.0°  
Efficiency 97 %  
Peak intensity 2.5 cd/lm  
LEDs/each optic 1  
Light colour/type White  
Required components:

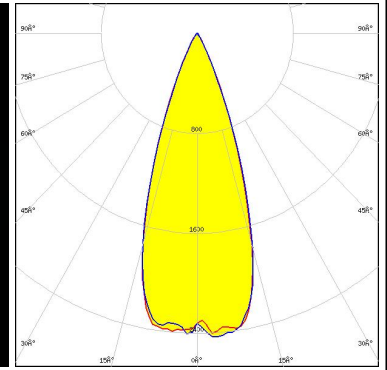

Light distribution files



LED SFT-40-WCS  
FWHM / FWTM 34.0° / 50.0°  
Efficiency 97 %  
Peak intensity 2.9 cd/lm  
LEDs/each optic 1  
Light colour/type White  
Required components:

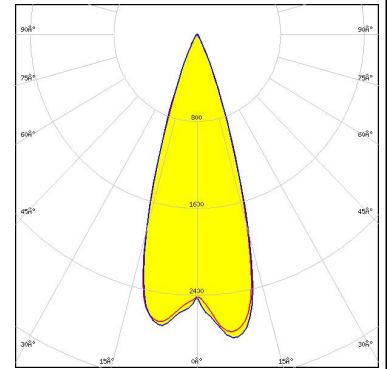

Light distribution files



LED NCSxE17A  
FWHM / FWTM 36.0° / 56.0°  
Efficiency 93 %  
Peak intensity 2.1 cd/lm  
LEDs/each optic 4  
Light colour/type White  
Required components:

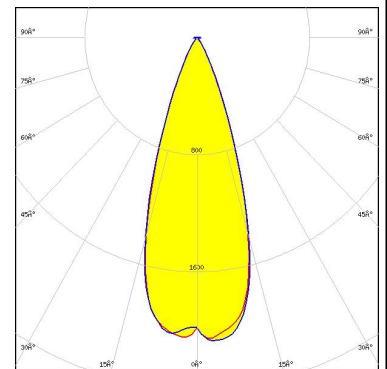

Light distribution files

### OPTICAL RESULTS (SIMULATED):



LED NV4WB35AM  
FWHM / FWTM 36.0° / 56.0°  
Efficiency 96 %  
Peak intensity 2.5 cd/lm  
LEDs/each optic 1  
Light colour/type White  
Required components:

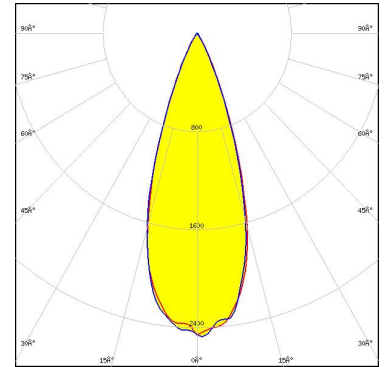

Light distribution files



LED NVSW219D  
FWHM / FWTM 42.0° / 60.0°  
Efficiency 95 %  
Peak intensity 1.9 cd/lm  
LEDs/each optic 1  
Light colour/type White  
Required components:

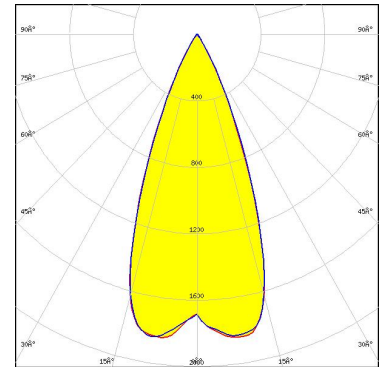

Light distribution files



LED OSCONIQ C 2424  
FWHM / FWTM 44.0° / 66.0°  
Efficiency 97 %  
Peak intensity 1.5 cd/lm  
LEDs/each optic 4  
Light colour/type White  
Required components:

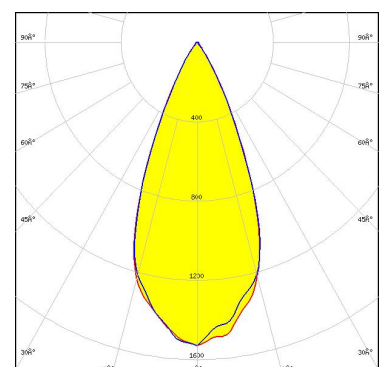

Light distribution files

#### OPTICAL RESULTS (SIMULATED):

**OSRAM**  
Opto Semiconductors

LED OSCONIQ P 3030  
 FWHM / FWTM 23.0° / 42.0°  
 Efficiency 96 %  
 Peak intensity 5 cd/lm  
 LEDs/each optic 1  
 Light colour/type White  
 Required components:

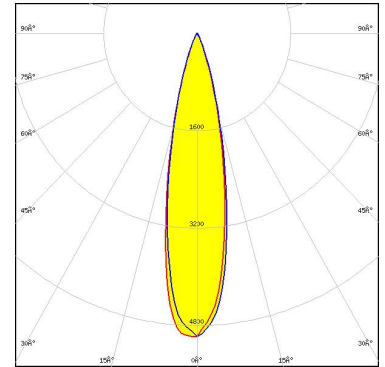

Light distribution files

**OSRAM**  
Opto Semiconductors

LED OSLO Pure 1414  
 FWHM / FWTM 22.0° / 40.0°  
 Efficiency 96 %  
 Peak intensity 5.5 cd/lm  
 LEDs/each optic 1  
 Light colour/type White  
 Required components:

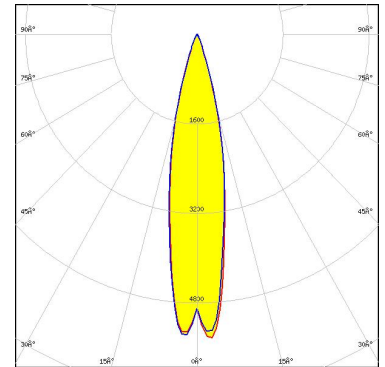

Light distribution files

**SAMSUNG**

LED LM28xB Series  
 FWHM / FWTM 29.0° / 50.0°  
 Efficiency 94 %  
 Peak intensity 3.5 cd/lm  
 LEDs/each optic 1  
 Light colour/type White  
 Required components:

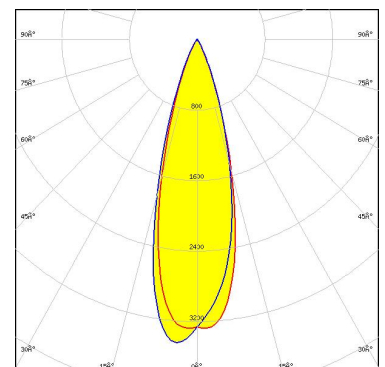

Light distribution files

#### OPTICAL RESULTS (SIMULATED):

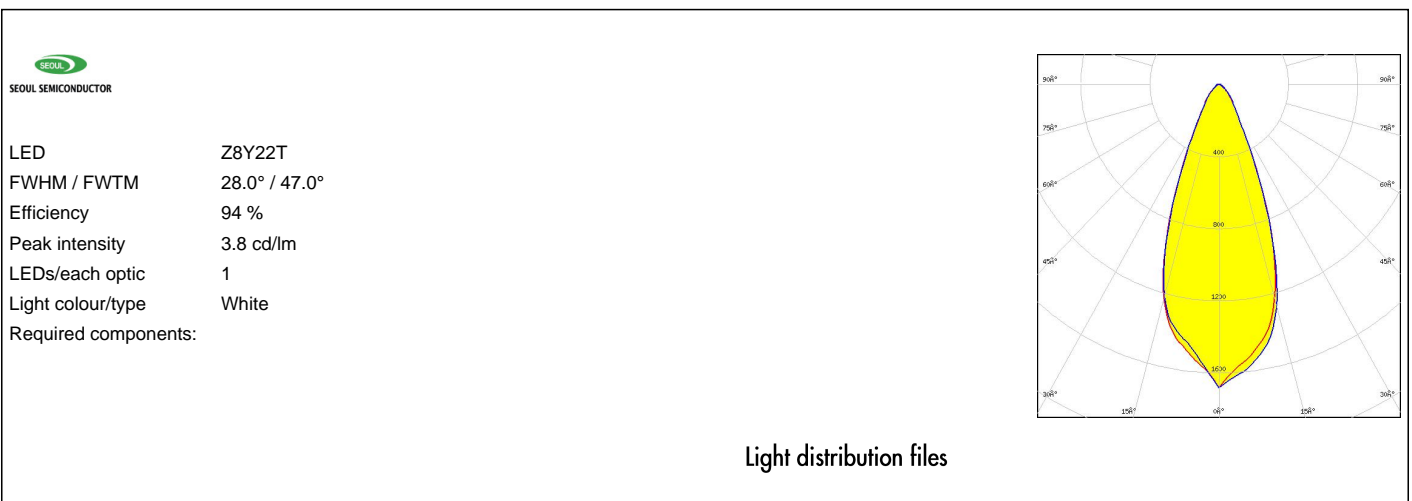
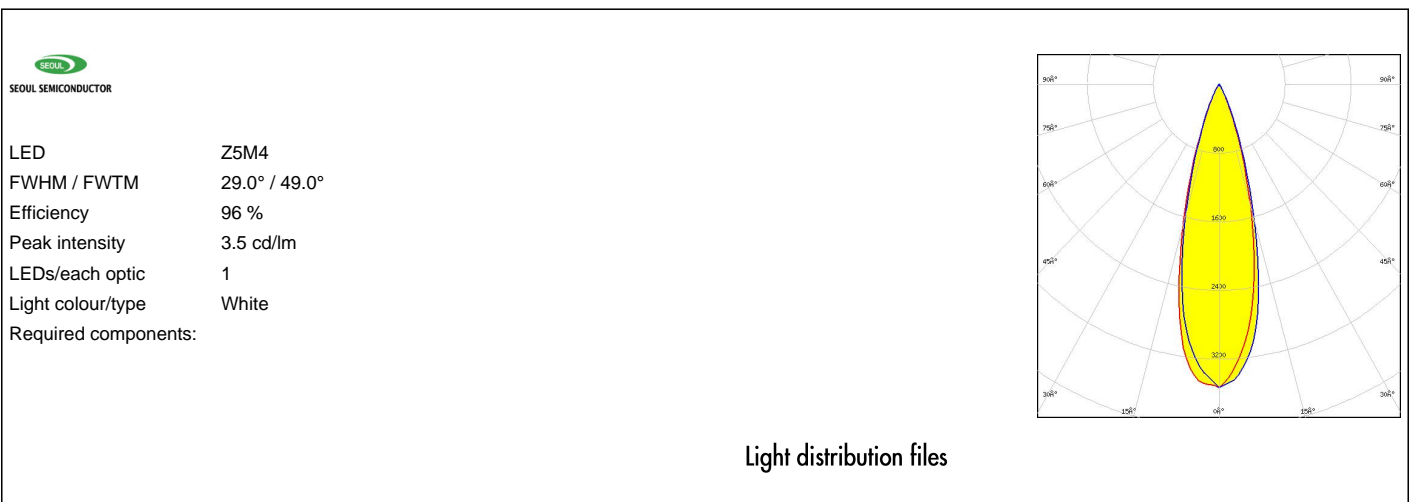
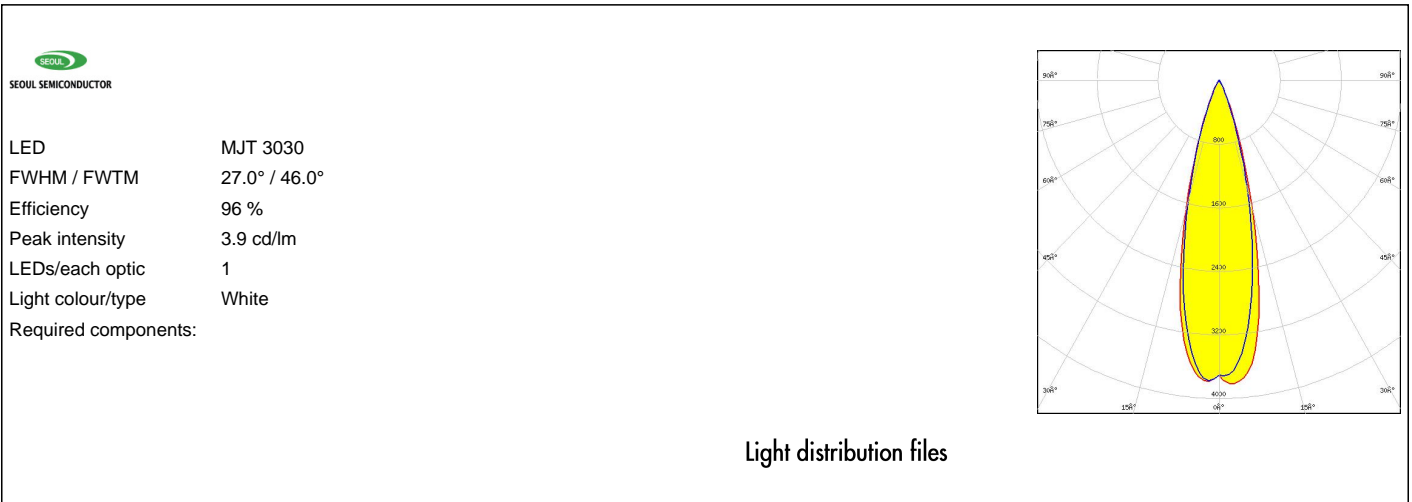



### GENERAL INFORMATION:

NOTE: The typical beam angle will be changed by different color, chip size and chip position tolerance. The typical total beam angle is the full angle measured where the luminous intensity is half of the peak value.

### MATERIALS:

As part of our continuous research and improvement processes, and to ensure the best possible quality and availability of our products, LEDiL reserves the right to change material grades without notice.

### PRODUCT DATA USER AGREEMENT AND DISCLAIMER:

The measured data in the provided downloadable LEDiL Product Datasheets and Mechanical 2D-Drawings is rounded and provided as reference for planning. LEDiL Oy's optical specifications have been verified by conducting performance testing of the products in accordance with the company's quality system. The reported data are averaged results of multiple measurements with typical variation. LEDiL Oy reserves the right to without prior notification make changes and improvements to its products.

LEDiL Oy assumes neither warranty, nor guarantee nor any other liability of any kind for the contents and correctness of the provided data. The provided data has been generated with highest diligence but the provided data may in reality not represent the complete possible variation range of all intrinsic parameters. Therefore, in certain cases a deviation from the provided data could occur.

LEDiL Oy reserves the right to undertake technical changes of its products without further notification which could lead to changes in the provided data. LEDiL Oy assumes no liability of any kind for the possible deviation from any provided data or any other damage resulting from the usage of the provided data.

The user agrees to this disclaimer and user agreement with the download or usage of the provided files.

#### LEDiL Oy

Joensuunkatu 7  
FI-24240 SALO  
Finland

#### LEDiL Inc.

228 West Page Street  
Suite D  
Sycamore IL 60178  
USA

#### Ledil Optics Technology (Shenzhen) Co., Ltd.

# 405 , Block B  
Casic Motor Building  
Shenzhen 518057  
P.R.CHINA

#### Local sales and technical support

[www.ledil.com/  
where\\_to\\_buy](http://www.ledil.com/where_to_buy)

#### Shipping locations

Poznan, Poland  
Hong Kong, China

#### Distribution Partners

[www.ledil.com/  
where\\_to\\_buy](http://www.ledil.com/where_to_buy)