

## MOLLY-M

~35° medium beam

### SPECIFICATION:

Dimensions	Ø 69.8 mm
Height	23.6 mm
ROHS compliant	yes ⓘ

### MATERIALS:

Component	Type	Material	Colour	Finish	Length
MOLLY-M	Single lens	PMMA	clear		69.8

### ORDERING INFORMATION:

Component	Qty in box	MOQ	MPQ	Box weight (kg)
C15801_MOLLY-M » Box size: 476 x 273 x 292 mm	198	36	18	9.0



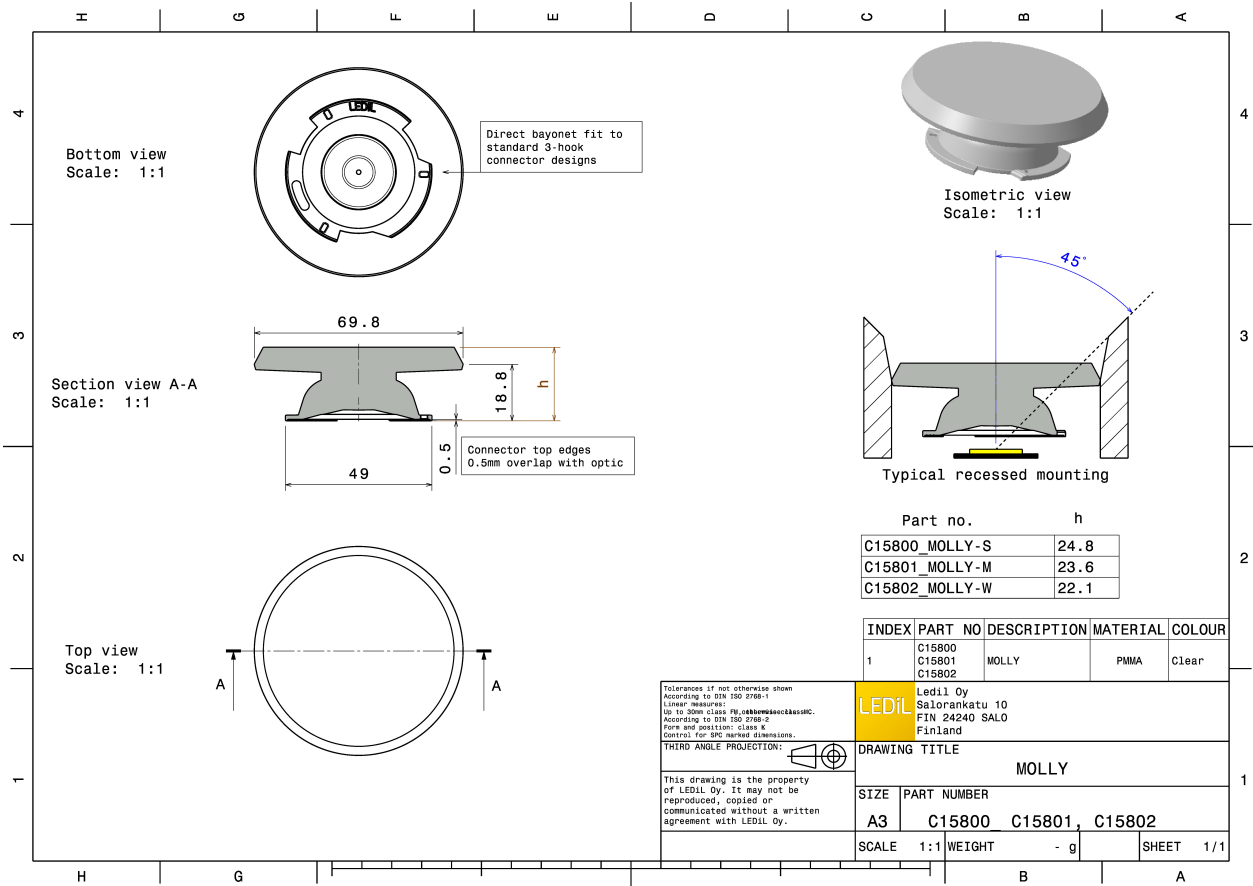

See also our general installation guide: [www.ledil.com/installation\\_guide](http://www.ledil.com/installation_guide)

### OPTICAL RESULTS (MEASURED):

bridgelux

LED V11 HD Gen 8  
 FWHM / FWTM 33.0° / 52.0°  
 Efficiency 90 %  
 Peak intensity 2.4 cd/lm  
 LEDs/each optic 1  
 Light colour/type White  
 Required components:  
 Bender Wirth: 633d 3Hook

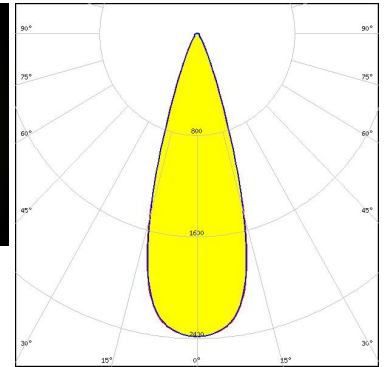

Light distribution files

bridgelux

LED Vero SE 13  
 FWHM / FWTM 36.0° / 54.0°  
 Efficiency 90 %  
 Peak intensity 2.1 cd/lm  
 LEDs/each optic 1  
 Light colour/type White  
 Required components:  
 C16402\_CLAMP-VEROSE-13-18

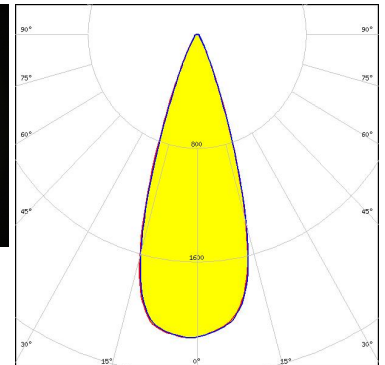
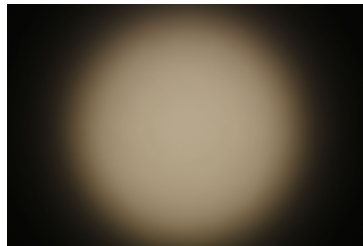

Light distribution files

bridgelux

LED Vero SE 18  
 FWHM / FWTM 40.0° / 62.0°  
 Efficiency 89 %  
 Peak intensity 1.7 cd/lm  
 LEDs/each optic 1  
 Light colour/type White  
 Required components:  
 C16402\_CLAMP-VEROSE-13-18

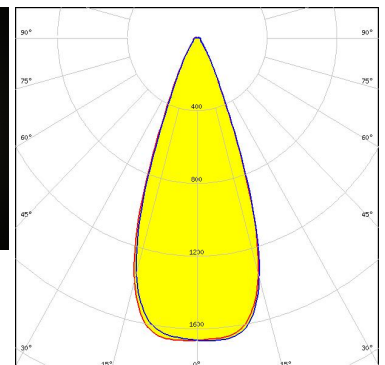
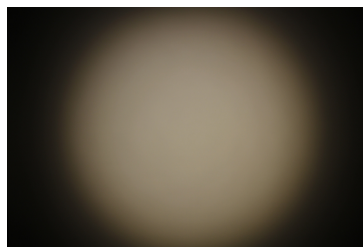

Light distribution files

### OPTICAL RESULTS (MEASURED):



**LED** Vesta TW 15mm DP  
**FWHM / FWTM** 38.0° / 58.0°  
**Efficiency** 90 %  
**Peak intensity** 1.9 cd/lm  
**LEDs/each optic** 1  
**Light colour/type** Tunable White  
**Required components:**  
 C13658\_CLAMP-VERO13-18  
 Bender Wirth: 482 Typ L2

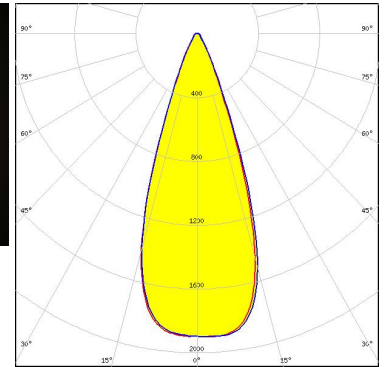
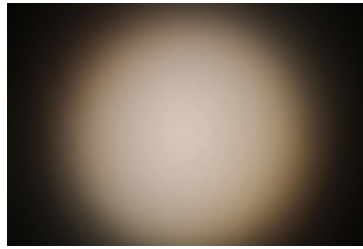

Light distribution files



**LED** Vesta TW 18mm (31W) DP  
**FWHM / FWTM** 40.0° / 61.0°  
**Efficiency** 88 %  
**Peak intensity** 1.7 cd/lm  
**LEDs/each optic** 1  
**Light colour/type** Tunable White  
**Required components:**  
 C13584\_CLAMP-VERO29  
 Bender Wirth: 483 Typ L3

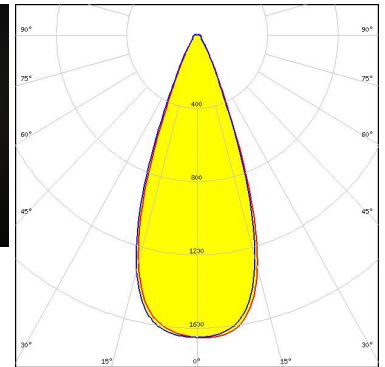

Light distribution files

### CITIZEN

**LED** CLL03x/CLU03x  
**FWHM / FWTM** 36.0° / 55.0°  
**Efficiency** 89 %  
**Peak intensity** 2.1 cd/lm  
**LEDs/each optic** 1  
**Light colour/type** White  
**Required components:**  
 Bender Wirth: 433 Typ L1

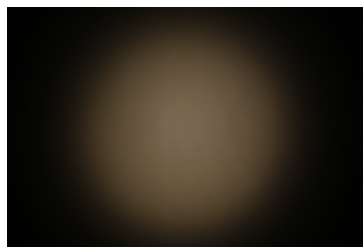



### OPTICAL RESULTS (MEASURED):

#### CITIZEN

LED LCN-C02B (Tunable White)  
 FWHM / FWTM 35.0° / 53.0°  
 Efficiency 89 %  
 Peak intensity 2.2 cd/lm  
 LEDs/each optic 1  
 Light colour/type White  
 Required components:  
 C13658\_CLAMP-VERO13-18  
 Bender Wirth: 481 Typ L2

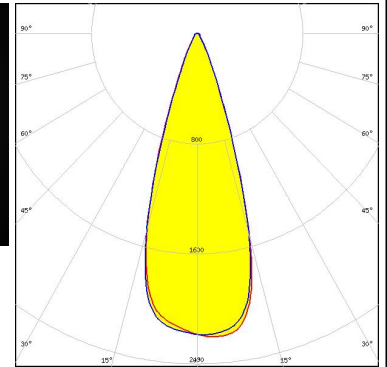

Light distribution files



LED CMA1840  
 FWHM / FWTM 37.0° / 56.0°  
 Efficiency 91 %  
 Peak intensity 2 cd/lm  
 LEDs/each optic 1  
 Light colour/type White  
 Required components:  
 C14123\_CLAMP-CXA15-18

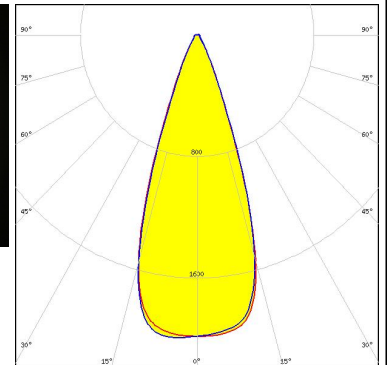
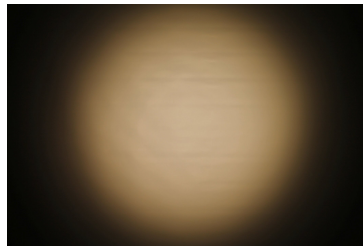

Light distribution files



LED CMA2550  
 FWHM / FWTM 42.0° / 62.0°  
 Efficiency 89 %  
 Peak intensity 1.6 cd/lm  
 LEDs/each optic 1  
 Light colour/type White  
 Required components:  
 C14036\_CLAMP\_CXA25-30

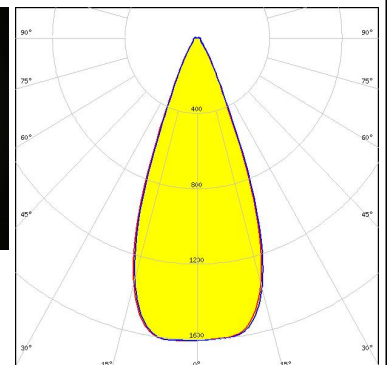
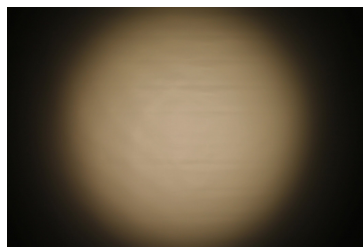

Light distribution files

### OPTICAL RESULTS (MEASURED):



**LED** CMA3090  
**FWHM / FWTM** 45.0° / 68.0°  
**Efficiency** 88 %  
**Peak intensity** 1.4 cd/lm  
**LEDs/each optic** 1  
**Light colour/type** White  
**Required components:**  
 C14036\_CLAMP\_CXA25-30

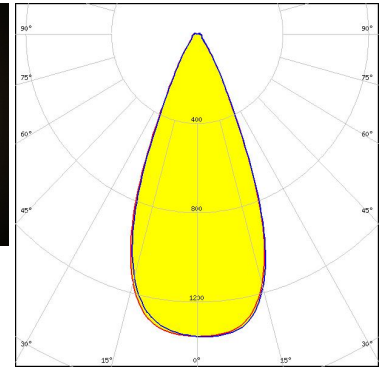
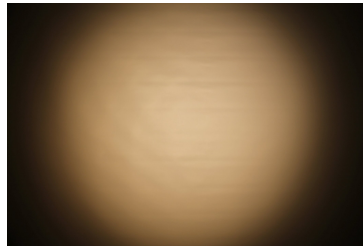

Light distribution files



**LED** CMT14xx  
**FWHM / FWTM** 33.0° / 50.0°  
**Efficiency** 90 %  
**Peak intensity** 2.5 cd/lm  
**LEDs/each optic** 1  
**Light colour/type** White  
**Required components:**  
 C13658\_CLAMP-VERO13-18  
 Bender Wirth: 434 Typ L1

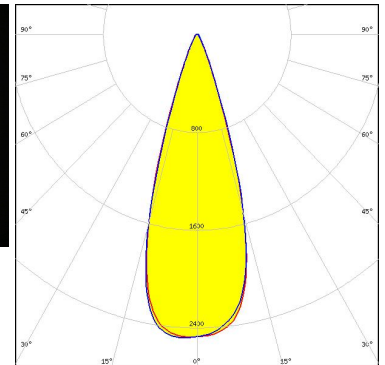
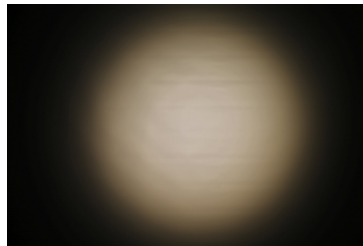

Light distribution files



**LED** CMT19xx  
**FWHM / FWTM** 36.0° / 55.0°  
**Efficiency** 90 %  
**Peak intensity** 2.1 cd/lm  
**LEDs/each optic** 1  
**Light colour/type** White  
**Required components:**  
 C13658\_CLAMP-VERO13-18  
 Bender Wirth: 477 Typ L1

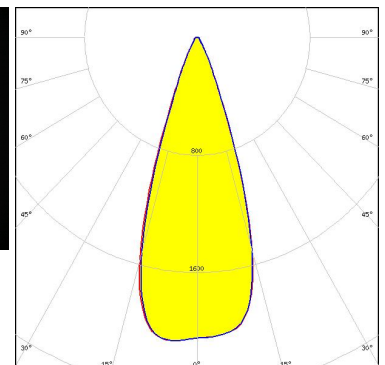
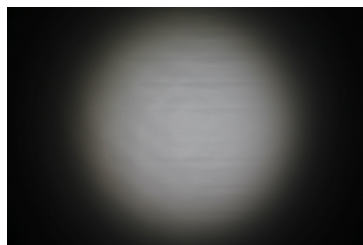

Light distribution files

### OPTICAL RESULTS (MEASURED):



**LED** CMT28xx  
**FWHM / FWTM** 42.0° / 65.0°  
**Efficiency** 87 %  
**Peak intensity** 1.5 cd/lm  
**LEDs/each optic** 1  
**Light colour/type** White  
**Required components:**  
 C13584\_CLAMP-VERO29  
 Bender Wirth: 471 Typ L3

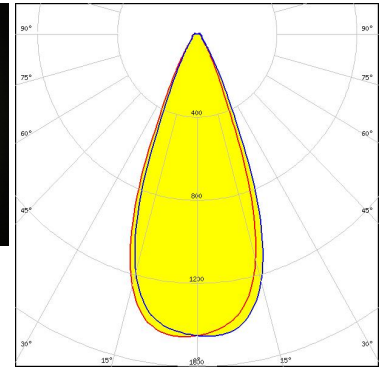
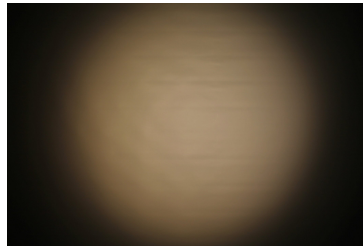

Light distribution files



**LED** CXA/B 15xx  
**FWHM / FWTM** 34.0° / 51.0°  
**Efficiency** 90 %  
**Peak intensity** 2.4 cd/lm  
**LEDs/each optic** 1  
**Light colour/type** White  
**Required components:**  
 C14123\_CLAMP-CXA15-18

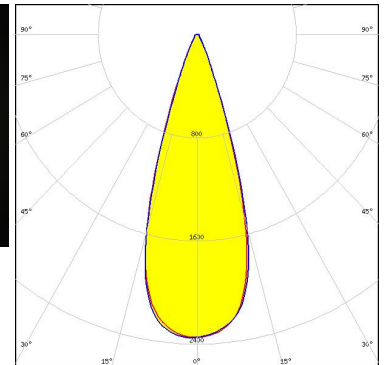

Light distribution files



**LED** LUXEON CoB 1204HD  
**FWHM / FWTM** 30.0° / 46.0°  
**Efficiency** 89 %  
**Peak intensity** 2.9 cd/lm  
**LEDs/each optic** 1  
**Light colour/type** White  
**Required components:**  
 TE Connectivity: 2213382-2 + OPTIC CLIP Z50 TYPE1 2213194-1

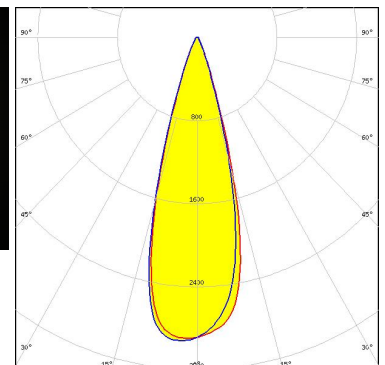
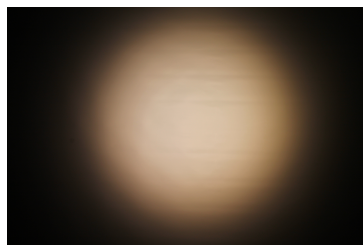

Light distribution files

### OPTICAL RESULTS (MEASURED):



**LED** CDM-14 (Dim-To-Warm)  
**FWHM / FWTM** 36.0° / 54.0°  
**Efficiency** 89 %  
**Peak intensity** 2 cd/lm  
**LEDs/each optic** 1  
**Light colour/type** White  
**Required components:**  
 C13658\_CLAMP-VERO13-18  
 Bender Wirth: 491 Typ L2

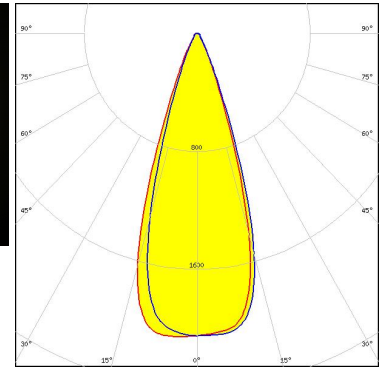
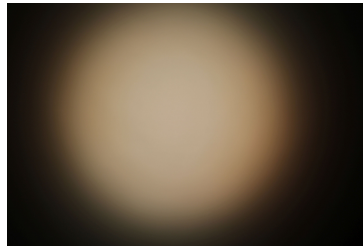

Light distribution files



**LED** CDM-18 (Dim-To-Warm)  
**FWHM / FWTM** 38.0° / 57.0°  
**Efficiency** 89 %  
**Peak intensity** 1.9 cd/lm  
**LEDs/each optic** 1  
**Light colour/type** White  
**Required components:**  
 C13658\_CLAMP-VERO13-18  
 Bender Wirth: 491 Typ L2

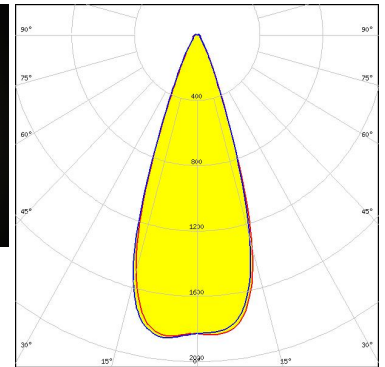
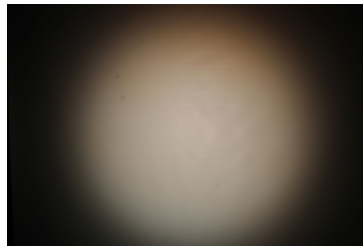

Light distribution files



**LED** CDM-9 (Dim-To-Warm)  
**FWHM / FWTM** 33.0° / 49.0°  
**Efficiency** 89 %  
**Peak intensity** 2.4 cd/lm  
**LEDs/each optic** 1  
**Light colour/type** White  
**Required components:**  
 C13658\_CLAMP-VERO13-18  
 Bender Wirth: 490 Typ L1

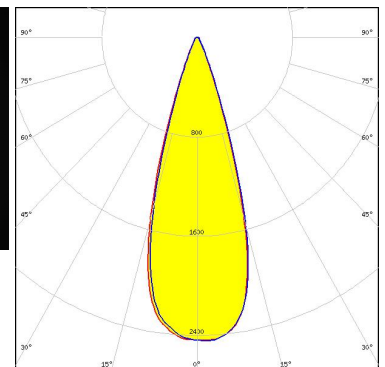
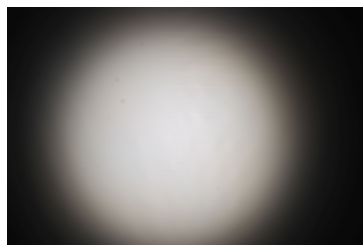

Light distribution files

### OPTICAL RESULTS (MEASURED):



**LED** CTM-14 (Tunable White)  
**FWHM / FWTM** 34.0° / 52.0°  
**Efficiency** 88 %  
**Peak intensity** 2.2 cd/lm  
**LEDs/each optic** 1  
**Light colour/type** White  
**Required components:**  
 C13584\_CLAMP-VERO29  
 Bender Wirth: 442 Typ L3

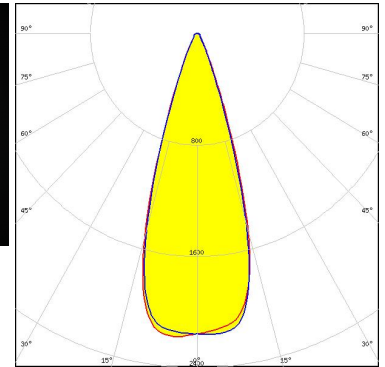
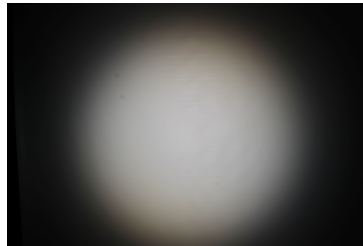

Light distribution files



**LED** CTM-14 RGBW  
**FWHM / FWTM** 35.0° / 55.0°  
**Efficiency** 88 %  
**Peak intensity** 2 cd/lm  
**LEDs/each optic** 1  
**Light colour/type** RGBW  
**Required components:**  
 C13584\_CLAMP-VERO29  
 Bender Wirth: 500 Typ L3-1

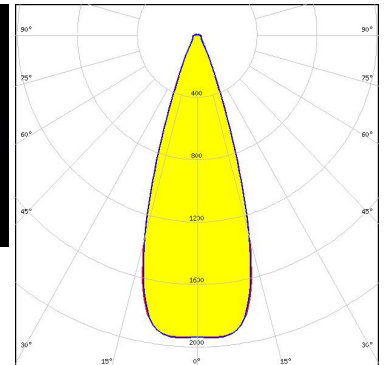
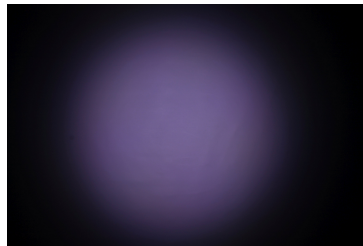

Light distribution files



**LED** CTM-22 (Tunable White)  
**FWHM / FWTM** 42.0° / 64.0°  
**Efficiency** 87 %  
**Peak intensity** 1.5 cd/lm  
**LEDs/each optic** 1  
**Light colour/type** White  
**Required components:**  
 C13584\_CLAMP-VERO29  
 Bender Wirth: 494 Typ L3

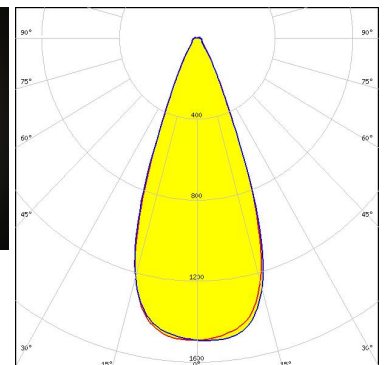
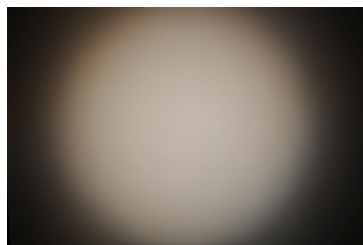

Light distribution files



### OPTICAL RESULTS (MEASURED):



**LED** NVCWJ024Z-V1MT: COB J-Type Tunable White  
**FWHM / FWTM** 33.0° / 51.0°  
**Efficiency** 89 %  
**Peak intensity** 2.4 cd/lm  
**LEDs/each optic** 1  
**Light colour/type** White  
**Required components:**  
 C13658\_CLAMP-VERO13-18  
 Bender Wirth: 498 Typ L2

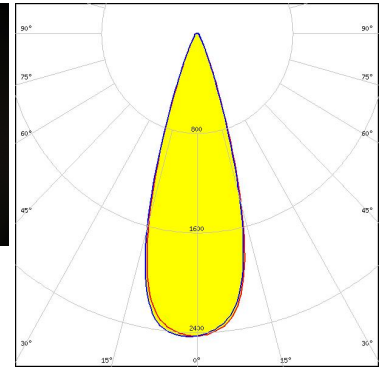
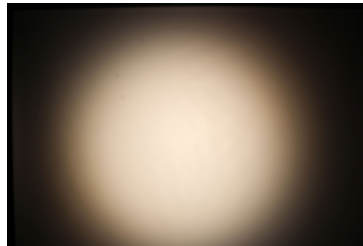

Light distribution files



**LED** PrevaLED Core G7 L15 H1  
**FWHM / FWTM** 35.0° / 55.0°  
**Efficiency** 90 %  
**Peak intensity** 2.1 cd/lm  
**LEDs/each optic** 1  
**Light colour/type** White  
**Required components:**  
 C16685\_CLAMP-PRV-A

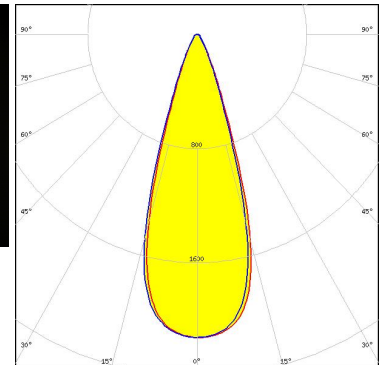
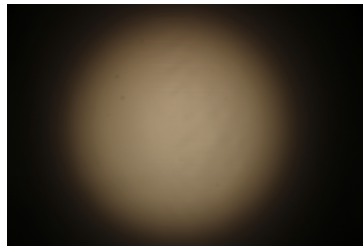

Light distribution files



**LED** Fortimo SLM L13 CoB  
**FWHM / FWTM** 35.0° / 53.0°  
**Efficiency** 89 %  
**Peak intensity** 2.2 cd/lm  
**LEDs/each optic** 1  
**Light colour/type** White  
**Required components:**  
 TE Connectivity: 2213130-2 + OPTIC CLIP Z50 TYPE1 2213194-1

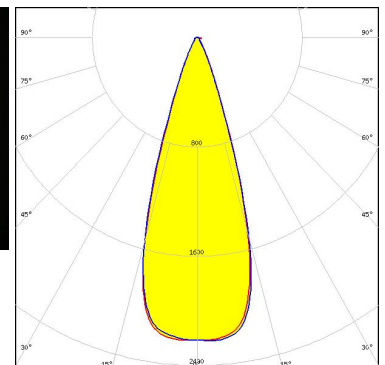
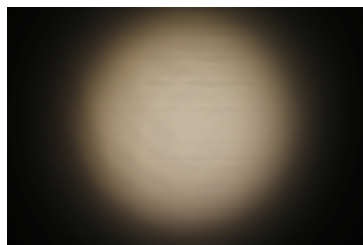

Light distribution files

### OPTICAL RESULTS (MEASURED):

#### PHILIPS

LED Fortimo SLM L15 + SLM holder  
 FWHM / FWTM 34.0° / 53.0°  
 Efficiency 89 %  
 Peak intensity 2.3 cd/lm  
 LEDs/each optic 1  
 Light colour/type White  
 Required components:  
 TE Connectivity: OPTIC CLIP Z50 TYPE1 2213194-1

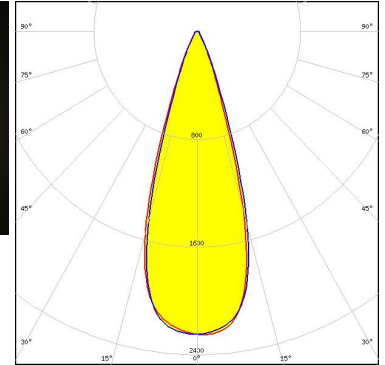
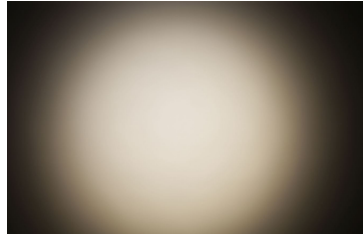

Light distribution files

#### PHILIPS

LED Fortimo SLM L15 CoB  
 FWHM / FWTM 36.0° / 54.0°  
 Efficiency 88 %  
 Peak intensity 2.1 cd/lm  
 LEDs/each optic 1  
 Light colour/type White  
 Required components:  
 TE Connectivity: 2213130-2 + OPTIC CLIP Z50 TYPE1 2213194-1

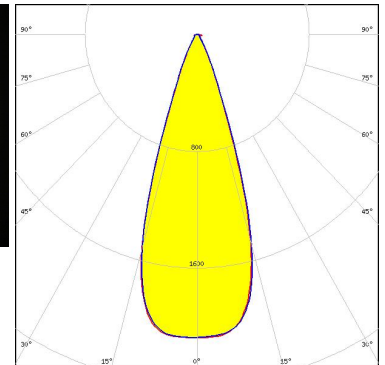
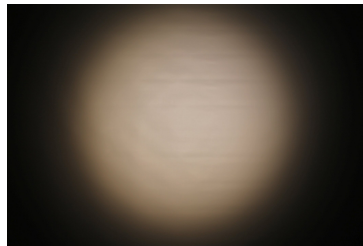

Light distribution files

#### SAMSUNG

LED LC035T (Tunable white)  
 FWHM / FWTM 43.0° / 67.0°  
 Efficiency 88 %  
 Peak intensity 1.4 cd/lm  
 LEDs/each optic 1  
 Light colour/type White  
 Required components:  
 C13584\_CLAMP-VERO29  
 Bender Wirth: 502 Typ L3

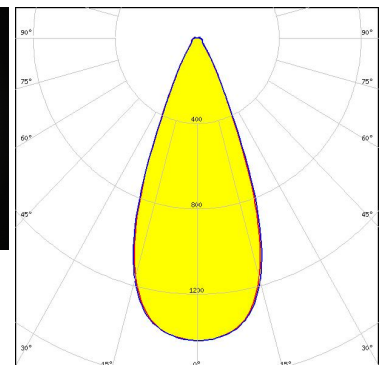
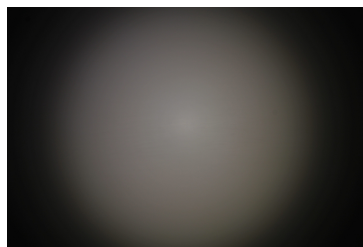

Light distribution files



## OPTICAL RESULTS (MEASURED):

### XICATO

LED XTM - 19mm LES  
FWHM / FWTM 39.0° / 60.0°  
Efficiency 90 %  
Peak intensity 1.8 cd/lm  
LEDs/each optic 1  
Light colour/type White  
Required components:  
C16491\_XTM-ADAPTER-50-A

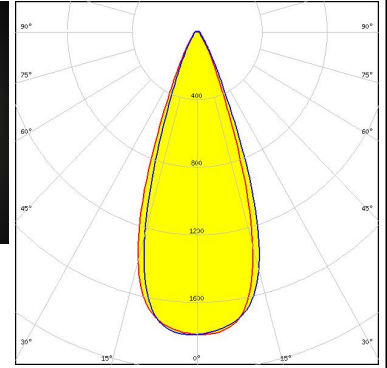

Light distribution files

### OPTICAL RESULTS (SIMULATED):



LED V9 HD Gen7  
FWHM / FWTM 32.0° / 44.0°  
Efficiency 90 %  
Peak intensity 3.3 cd/lm  
LEDs/each optic 1  
Light colour/type White

Required components:

C13658\_CLAMP-VERO13-18

Bender Wirth: 496 Typ L1

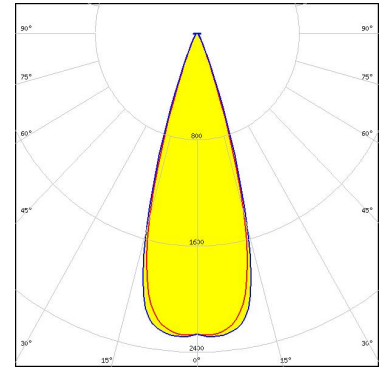

Light distribution files



LED VERO13  
FWHM / FWTM 32.0° / 46.0°  
Efficiency 91 %  
Peak intensity 3.1 cd/lm  
LEDs/each optic 1  
Light colour/type White

Required components:

C13658\_CLAMP-VERO13-18

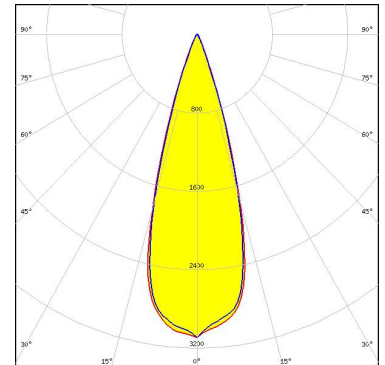

Light distribution files

## CITIZEN

LED CLL02x/CLU02x (LES10)  
FWHM / FWTM 30.0° / 42.0°  
Efficiency 89 %  
Peak intensity 3.6 cd/lm  
LEDs/each optic 1  
Light colour/type White

Required components:

Bender Wirth: 434 Typ L1

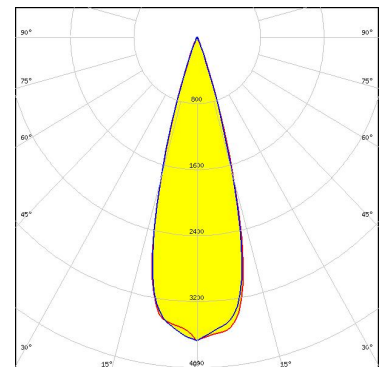

Light distribution files

### OPTICAL RESULTS (SIMULATED):



LED CXA/B 1816 & CXA/B 1820 & CXA 1850  
FWHM / FWTM 33.0° / 47.0°  
Efficiency 90 %  
Peak intensity 3.1 cd/lm  
LEDs/each optic 1  
Light colour/type White  
Required components:  
C14123\_CLAMP-CXA15-18

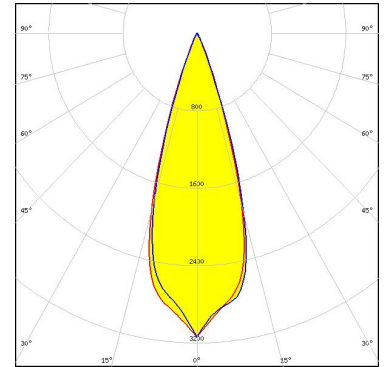

Light distribution files



LED CXA/B 25xx  
FWHM / FWTM 36.0° / 50.0°  
Efficiency 88 %  
Peak intensity 2.2 cd/lm  
LEDs/each optic 1  
Light colour/type White  
Required components:  
C14036\_CLAMP\_CXA25-30

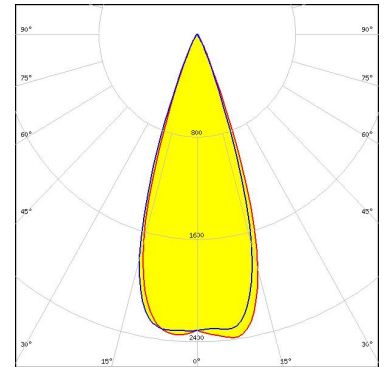

Light distribution files



LED CTM-18 (Tunable White)  
FWHM / FWTM 34.0° / 47.0°  
Efficiency 80 %  
Peak intensity 2.3 cd/lm  
LEDs/each optic 1  
Light colour/type White  
Required components:  
C13658\_CLAMP-VERO13-18

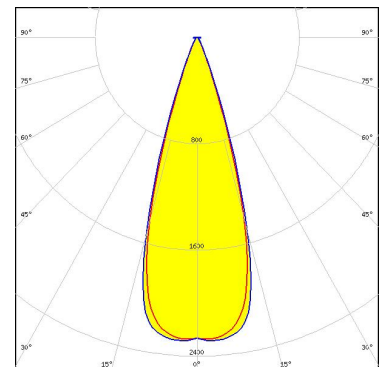

Light distribution files

### GENERAL INFORMATION:

NOTE: The typical beam angle will be changed by different color, chip size and chip position tolerance. The typical total beam angle is the full angle measured where the luminous intensity is half of the peak value.

Due to use of high power COB's with this product, special attention to proper thermal design is highly recommended. LEDiL has no liability for direct, indirect or consecutive damages arising from the LEDiL products being used outside of the recommended temperature range.

### MATERIALS:

As part of our continuous research and improvement processes, and to ensure the best possible quality and availability of our products, LEDiL reserves the right to change material grades without notice.

### PRODUCT DATA USER AGREEMENT AND DISCLAIMER:

The measured data in the provided downloadable LEDiL Product Datasheets and Mechanical 2D-Drawings is rounded and provided as reference for planning. LEDiL Oy's optical specifications have been verified by conducting performance testing of the products in accordance with the company's quality system. The reported data are averaged results of multiple measurements with typical variation. LEDiL Oy reserves the right to without prior notification make changes and improvements to its products.

LEDiL Oy assumes neither warranty, nor guarantee nor any other liability of any kind for the contents and correctness of the provided data. The provided data has been generated with highest diligence but the provided data may in reality not represent the complete possible variation range of all intrinsic parameters. Therefore, in certain cases a deviation from the provided data could occur.

LEDiL Oy reserves the right to undertake technical changes of its products without further notification which could lead to changes in the provided data. LEDiL Oy assumes no liability of any kind for the possible deviation from any provided data or any other damage resulting from the usage of the provided data.

The user agrees to this disclaimer and user agreement with the download or usage of the provided files.

#### LEDiL Oy

Joensuunkatu 13  
FI-24240 SALO  
Finland

#### LEDiL Inc.

228 West Page Street  
Suite D  
Sycamore IL 60178  
USA

#### Ledil Optics Technology (Shenzhen) Co., Ltd.

# 405 , Block B  
Casic Motor Building  
Shenzhen 518057  
P.R.CHINA

#### Local sales and technical support

[www.ledil.com/  
where\\_to\\_buy](http://www.ledil.com/where_to_buy)

#### Shipping locations

Poznan, Poland  
Hong Kong, China

#### Distribution Partners

[www.ledil.com/  
where\\_to\\_buy](http://www.ledil.com/where_to_buy)