

CARMEN-M-B

~35° medium beam. Assembly with holder B compatible with Ø40 mm BJB and B+W connectors.

SPECIFICATION:

Dimensions	Ø 69.5 mm
Height	36.3 mm
Fastening	socket
ROHS compliant	yes ⓘ



MATERIALS:

Component	Type	Material	Colour	Finish	Length
CARMEN-M	Single lens	PMMA	clear		66.4
CARMEN-HLD-B	Holder	PC	black		69.9

ORDERING INFORMATION:

Component		Qty in box	MOQ	MPQ	Box weight (kg)
CP15215_CARMEN-M-B	Single lens	150	150	15	6.0
» Box size: 476 x 273 x 292 mm					

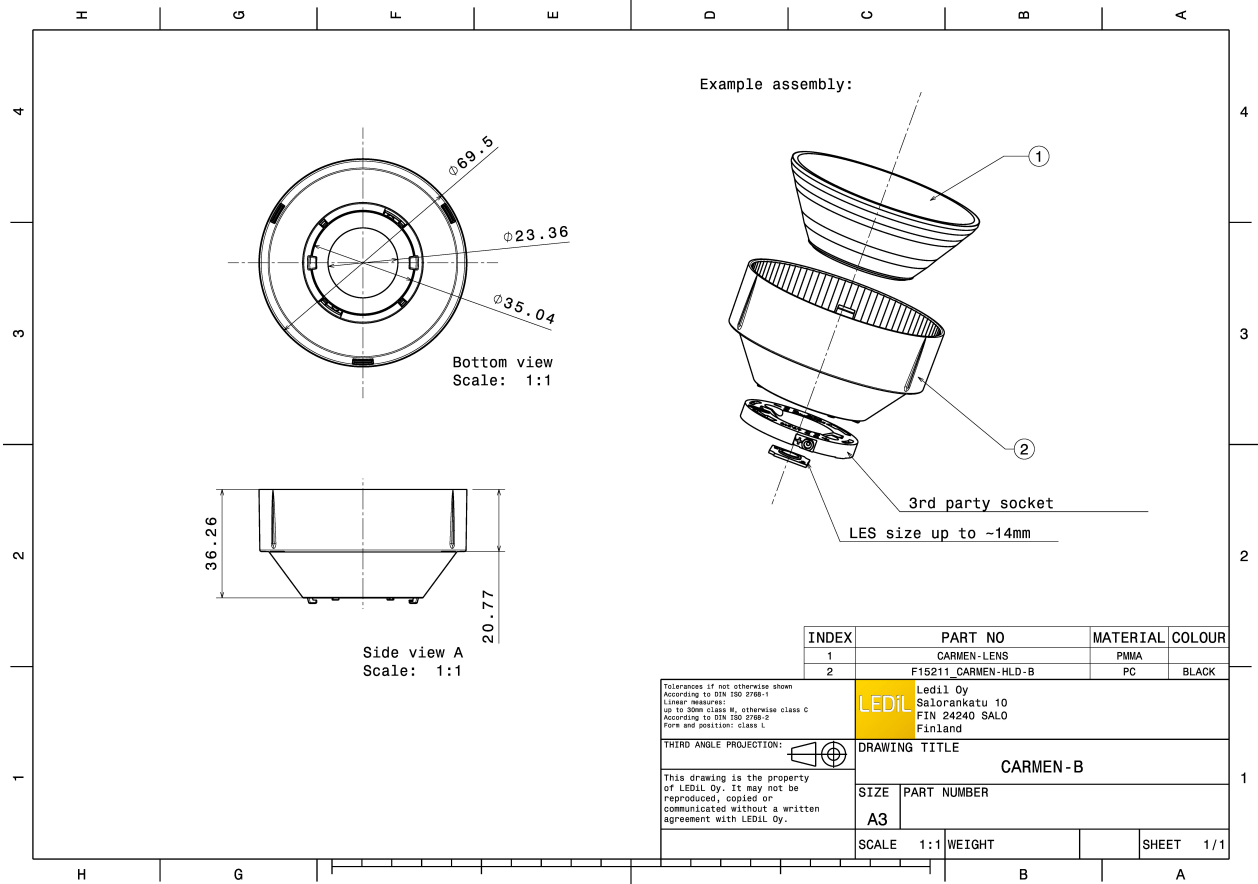

See also our general installation guide: www.ledil.com/installation_guide

OPTICAL RESULTS (MEASURED):



LED V10 Gen7
FWHM / FWTM 44.0° / 73.0°
Efficiency 73 %
Peak intensity 1.2 cd/lm
LEDs/each optic 1
Light colour/type White
Required components:
BJB: 47.319.6060

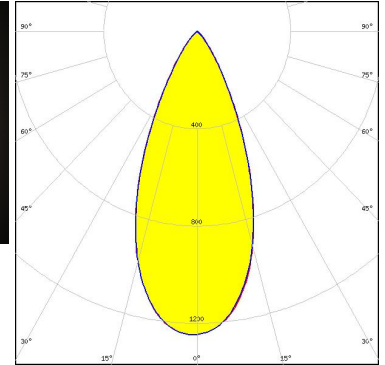

Light distribution files

CITIZEN

LED CLU700/701/702/703
FWHM / FWTM 38.0° / 60.0°
Efficiency 81 %
Peak intensity 1.9 cd/lm
LEDs/each optic 1
Light colour/type White
Required components:
BJB: 47.319.6060

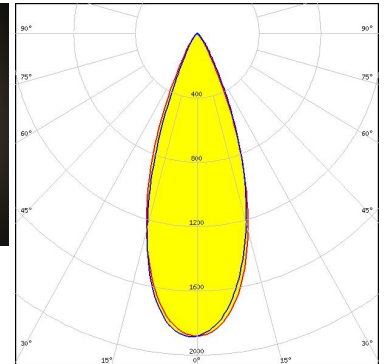
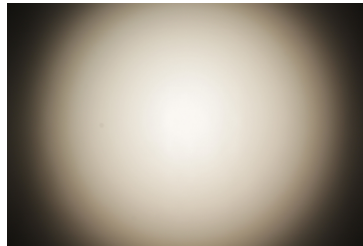

Light distribution files



LED CXA/B 13xx
FWHM / FWTM 38.0° / 61.0°
Efficiency 83 %
Peak intensity 1.9 cd/lm
LEDs/each optic 1
Light colour/type White
Required components:
BJB: 47.319.6120

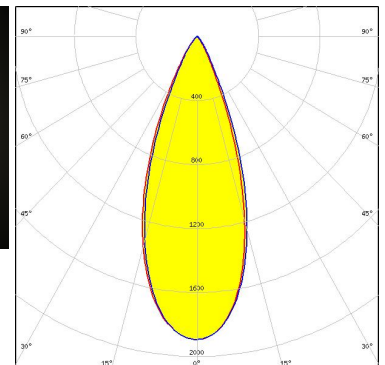
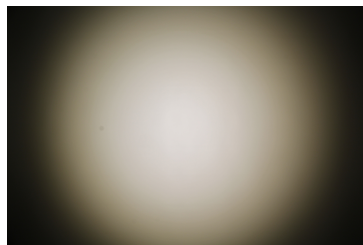

Light distribution files

OPTICAL RESULTS (MEASURED):



LED CXA/B 15xx
FWHM / FWTM 44.0° / 63.0°
Efficiency 80 %
Peak intensity 1.6 cd/lm
LEDs/each optic 1
Light colour/type White
Required components:
BJB: 47.319.6101

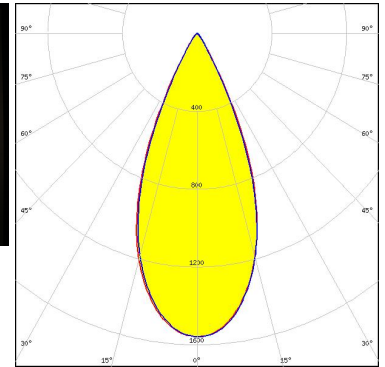
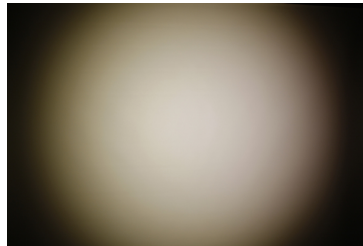

Light distribution files



LED LC003D / LC006D / LC009D / LC013D
FWHM / FWTM 48.0° / 70.0°
Efficiency 76 %
Peak intensity 1.2 cd/lm
LEDs/each optic 1
Light colour/type White
Required components:
BJB: 47.319.6060

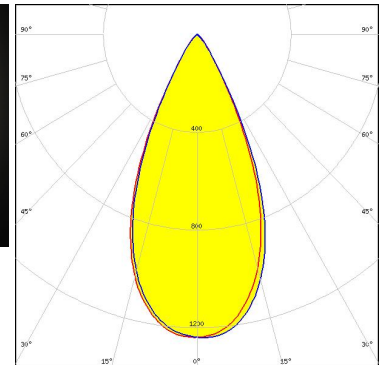
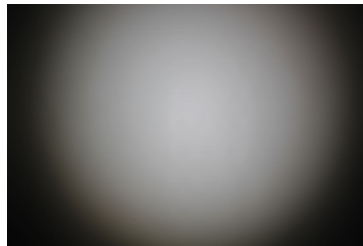

Light distribution files



LED LC003D / LC006D / LC009D / LC013D
FWHM / FWTM 48.0° / 70.0°
Efficiency 76 %
Peak intensity 1.2 cd/lm
LEDs/each optic 1
Light colour/type White
Required components:
A.A.G. STUCCHI: 8100-G2

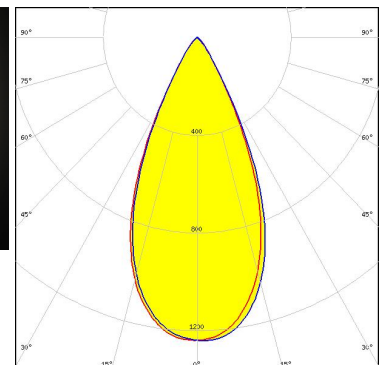
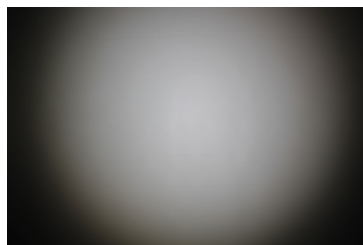

Light distribution files

OPTICAL RESULTS (MEASURED):

 SEOUL SEMICONDUCTOR		
LED	MJT COB LES 6	
FWHM / FWTM	38.0° / 66.0°	
Efficiency	76 %	
Peak intensity	1.6 cd/lm	
LEDs/each optic	1	
Light colour/type	White	
Required components:		
BJB: 47.319.6060		

Light distribution files

GENERAL INFORMATION:

NOTE: The typical beam angle will be changed by different color, chip size and chip position tolerance. The typical total beam angle is the full angle measured where the luminous intensity is half of the peak value.

Due to use of high power COB's with this product, special attention to proper thermal design is highly recommended. LEDiL has no liability for direct, indirect or consecutive damages arising from the LEDiL products being used outside of the recommended temperature range.

MATERIALS:

As part of our continuous research and improvement processes, and to ensure the best possible quality and availability of our products, LEDiL reserves the right to change material grades without notice.

PRODUCT DATA USER AGREEMENT AND DISCLAIMER:

The measured data in the provided downloadable LEDiL Product Datasheets and Mechanical 2D-Drawings is rounded and provided as reference for planning. LEDiL Oy's optical specifications have been verified by conducting performance testing of the products in accordance with the company's quality system. The reported data are averaged results of multiple measurements with typical variation. LEDiL Oy reserves the right to without prior notification make changes and improvements to its products.

LEDiL Oy assumes neither warranty, nor guarantee nor any other liability of any kind for the contents and correctness of the provided data. The provided data has been generated with highest diligence but the provided data may in reality not represent the complete possible variation range of all intrinsic parameters. Therefore, in certain cases a deviation from the provided data could occur.

LEDiL Oy reserves the right to undertake technical changes of its products without further notification which could lead to changes in the provided data. LEDiL Oy assumes no liability of any kind for the possible deviation from any provided data or any other damage resulting from the usage of the provided data.

The user agrees to this disclaimer and user agreement with the download or usage of the provided files.

LEDiL Oy

Joensuunkatu 13
FI-24240 SALO
Finland

LEDiL Inc.

228 West Page Street
Suite D
Sycamore IL 60178
USA

Ledil Optics Technology (Shenzhen) Co., Ltd.

405 , Block B
Casic Motor Building
Shenzhen 518057
P.R.CHINA

Local sales and technical support

[www.ledil.com/
where_to_buy](http://www.ledil.com/where_to_buy)

Shipping locations

Poznan, Poland
Hong Kong, China

Distribution Partners

[www.ledil.com/
where_to_buy](http://www.ledil.com/where_to_buy)