

HB-2X2-ON

~15° + 50° oval beam

SPECIFICATION:

Dimensions	50.0 x 50.0
Height	10 mm
Fastening	screw
ROHS compliant	yes ⓘ

MATERIALS:

Component	Type	Material	Colour	Finish	Length (mm)
HB-2X2-ON	Multi-lens	PMMA	clear		



ORDERING INFORMATION:

Component	Qty in box	MOQ	MPQ	Box weight (kg)
C15925_HB-2X2-ON » Box size: 480 x 280 x 300 mm	800	160	160	9.8

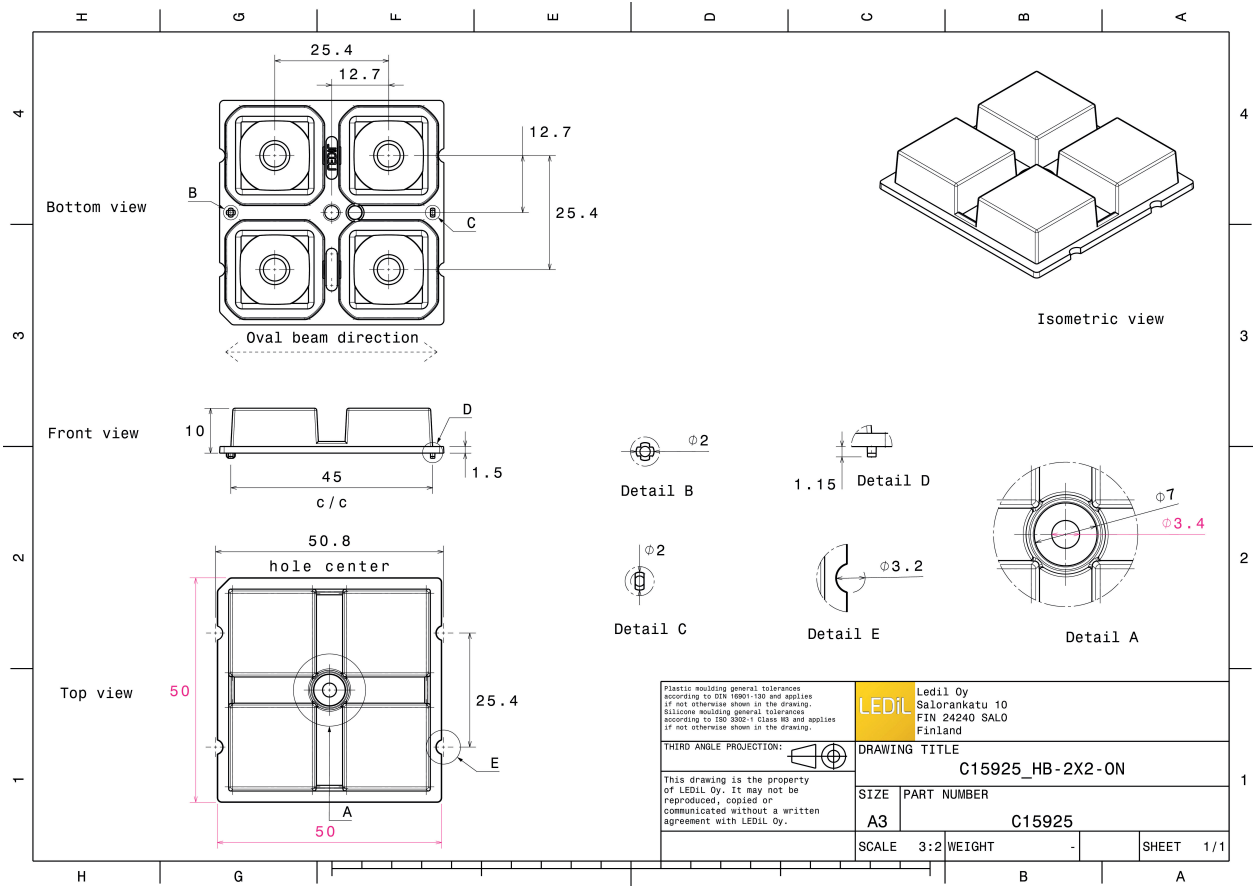

See also our general installation guide: www.ledil.com/installation_guide

OPTICAL RESULTS (MEASURED):



LED QUICK FLUX XTP 2x4 xxx LS G5
FWHM / FWTM 16.0 + 55.0° / 40.0 + 83.0°
Efficiency 93 %
Peak intensity 2.3 cd/lm
LEDs/each optic 1
Light colour/type White
Required components:

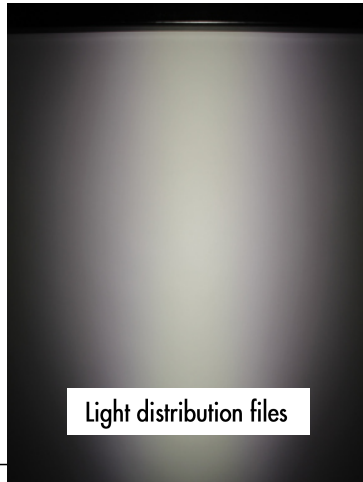

Light distribution files

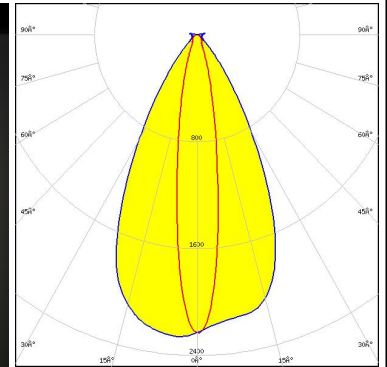

LED QUICK FLUX XTP 2x6 xxx LS G5
FWHM / FWTM 16.0 + 55.0° / 40.0 + 83.0°
Efficiency 93 %
Peak intensity 2.3 cd/lm
LEDs/each optic 1
Light colour/type White
Required components:

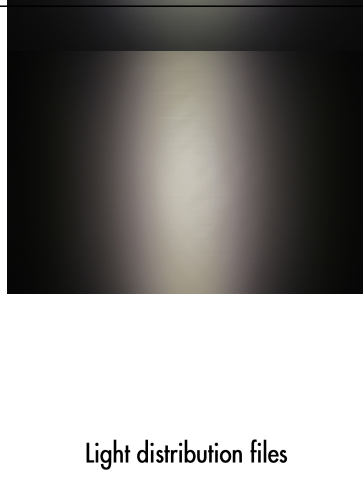

Light distribution files

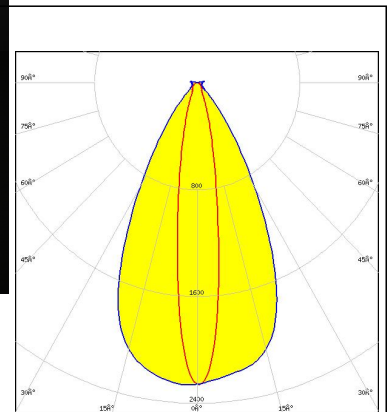

LED J Series 5050C 6V E Class
FWHM / FWTM 25.0 + 51.0° / 64.0 + 87.0°
Efficiency 90 %
Peak intensity 1.5 cd/lm
LEDs/each optic 1
Light colour/type White
Required components:

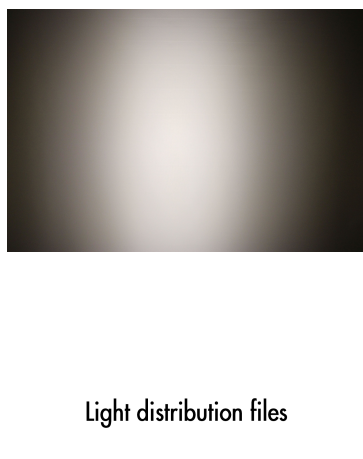

Light distribution files

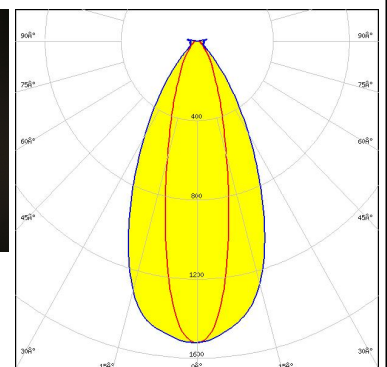

OPTICAL RESULTS (MEASURED):



LED XD16
 FWHM / FWTM 27.0 + 49.0° / 62.0 + 89.0°
 Efficiency 90 %
 Peak intensity 1.4 cd/lm
 LEDs/each optic 4
 Light colour/type White
 Required components:

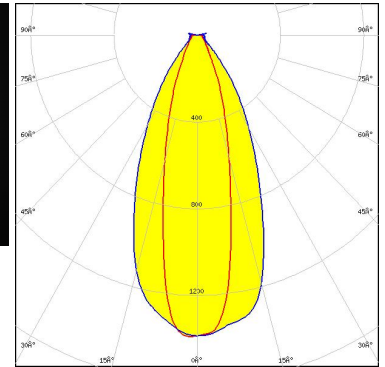
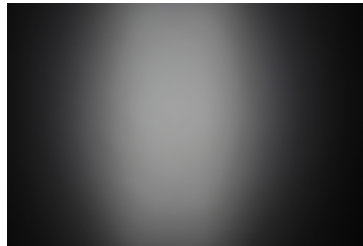

Light distribution files



LED XD16
 FWHM / FWTM 13.0 + 55.0° / 34.0 + 82.0°
 Efficiency 89 %
 Peak intensity 2.4 cd/lm
 LEDs/each optic 1
 Light colour/type White
 Required components:

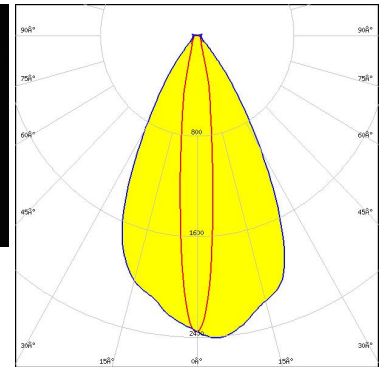
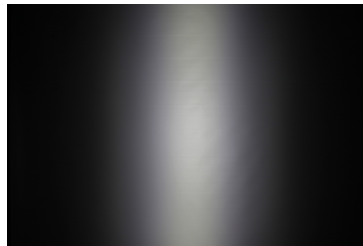

Light distribution files



LED XP-G2
 FWHM / FWTM 14.0 + 55.0° / 34.0 + 82.0°
 Efficiency 89 %
 Peak intensity 2.7 cd/lm
 LEDs/each optic 1
 Light colour/type White
 Required components:

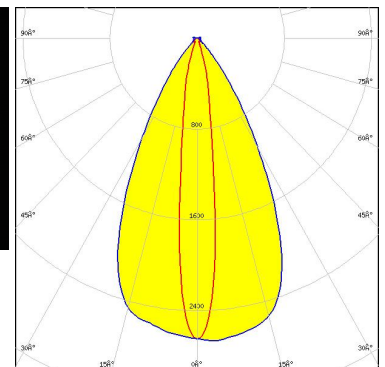
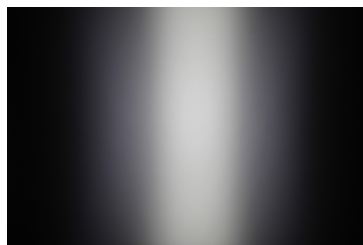

Light distribution files

OPTICAL RESULTS (MEASURED):



LED XP-L HI
 FWHM / FWTM 14.0 + 55.0° / 36.0 + 82.0°
 Efficiency 91 %
 Peak intensity 2.6 cd/lm
 LEDs/each optic 1
 Light colour/type White
 Required components:

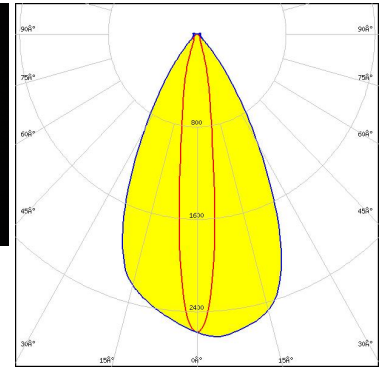
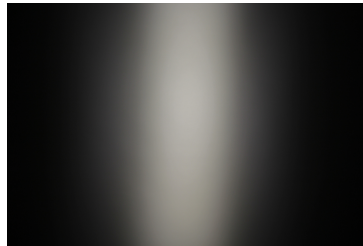

Light distribution files



LED PL-BRICK HP 3800 2x8 SSG
 FWHM / FWTM 17.0 + 54.0° / 41.0 + 84.0°
 Efficiency 92 %
 Peak intensity 2.3 cd/lm
 LEDs/each optic 1
 Light colour/type White
 Required components:

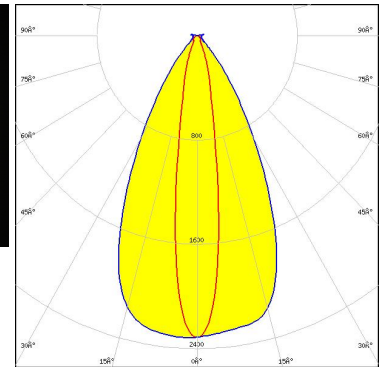
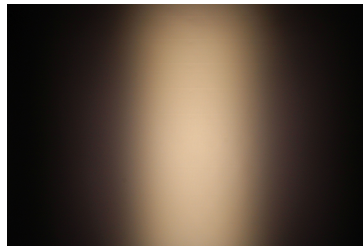

Light distribution files



LED PrevaLED Brick HP 2x8
 FWHM / FWTM 15.0 + 54.0° / 36.0 + 82.0°
 Efficiency 91 %
 Peak intensity 2.6 cd/lm
 LEDs/each optic 1
 Light colour/type White
 Required components:

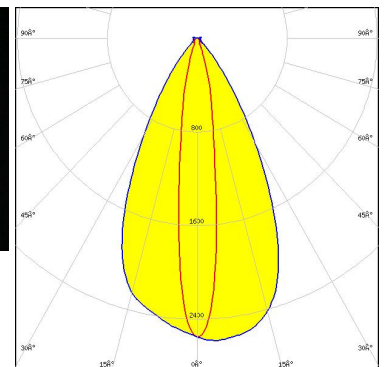
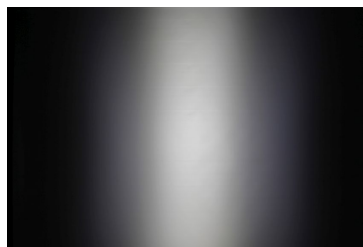

Light distribution files

OPTICAL RESULTS (MEASURED):



LED LUXEON V
FWHM / FWTM 22.0 + 51.0° / 52.0 + 86.0°
Efficiency 92 %
Peak intensity 1.8 cd/lm
LEDs/each optic 1
Light colour/type White
Required components:

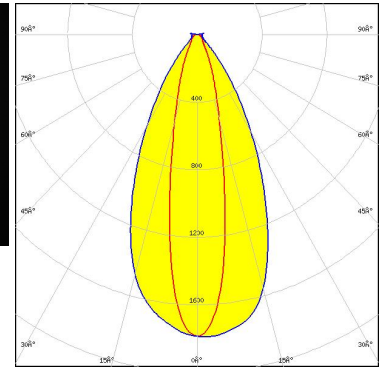
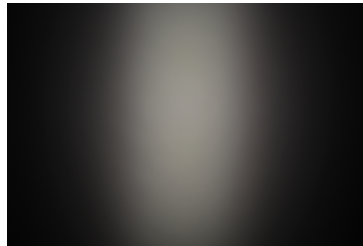

Light distribution files



LED RecLED 122x50mm 1900lm 730 2x4 Opt G1
FWHM / FWTM 15.0 + 54.0° / 38.5 + 82.5°
Efficiency 94 %
Peak intensity 2.4 cd/lm
LEDs/each optic 1
Light colour/type White
Required components:

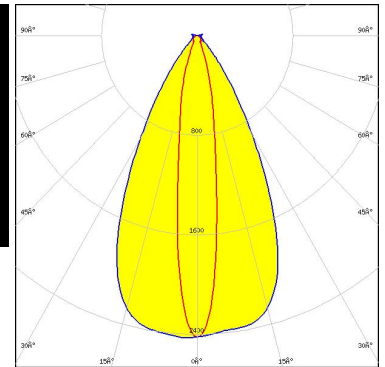
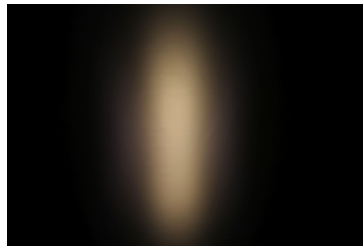

Light distribution files



LED NVSW219F
FWHM / FWTM 17.0 + 53.0° / 40.0 + 83.0°
Efficiency 93 %
Peak intensity 2.4 cd/lm
LEDs/each optic 1
Light colour/type White
Required components:

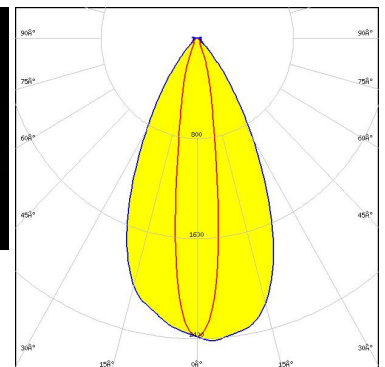
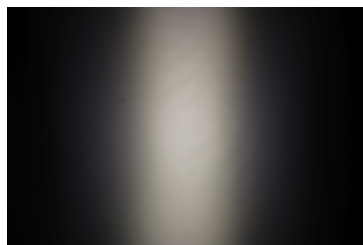

Light distribution files

OPTICAL RESULTS (MEASURED):



LED NVSW319B
 FWHM / FWTM 18.0 + 52.0° / 41.0 + 84.0°
 Efficiency 93 %
 Peak intensity 2.3 cd/lm
 LEDs/each optic 1
 Light colour/type White
 Required components:

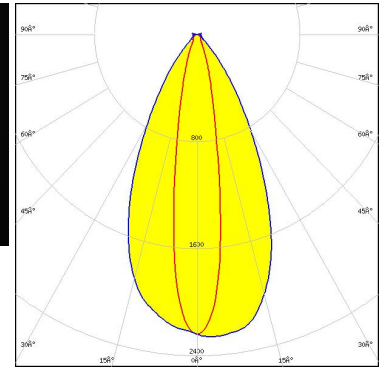
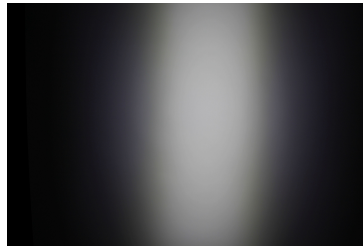

Light distribution files



LED Duris S8
 FWHM / FWTM 31.0 + 49.0° / 78.0 + 91.0°
 Efficiency 92 %
 Peak intensity 1.3 cd/lm
 LEDs/each optic 1
 Light colour/type White
 Required components:

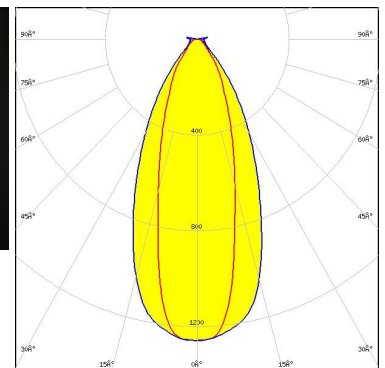
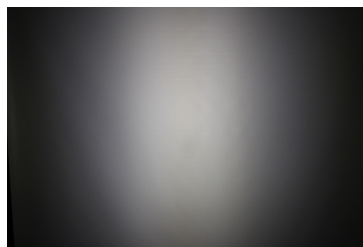

Light distribution files



LED OSLOM Square CSSRM2/CSSRM3
 FWHM / FWTM 15.0 + 54.0° / 36.0 + 82.0°
 Efficiency 91 %
 Peak intensity 2.6 cd/lm
 LEDs/each optic 1
 Light colour/type White
 Required components:

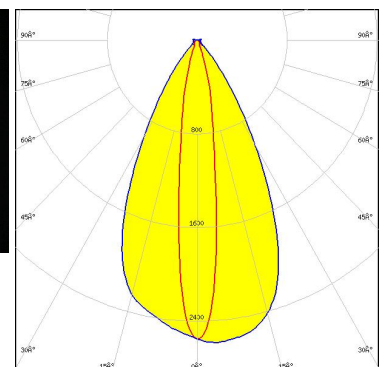
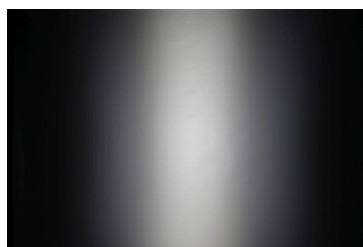

Light distribution files

OPTICAL RESULTS (MEASURED):

PHILIPS

LED Fortimo FastFlex LED 2x8 DA G4+
 FWHM / FWTM 18.0 + 53.0° / 41.0 + 84.0°
 Efficiency 94 %
 Peak intensity 2.2 cd/lm
 LEDs/each optic 1
 Light colour/type White
 Required components:

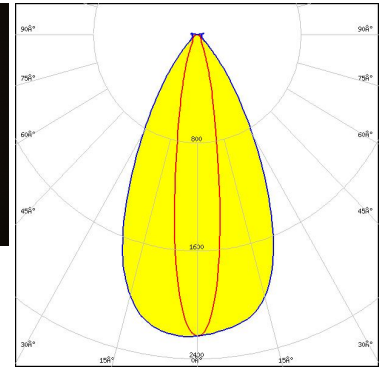

Light distribution files

SAMSUNG

LED HiLOM RH16 (LH351C)
 FWHM / FWTM 17.0 + 54.0° / 42.0 + 84.0°
 Efficiency 94 %
 Peak intensity 2.3 cd/lm
 LEDs/each optic 1
 Light colour/type White
 Required components:

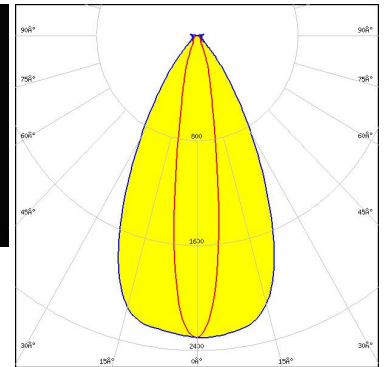
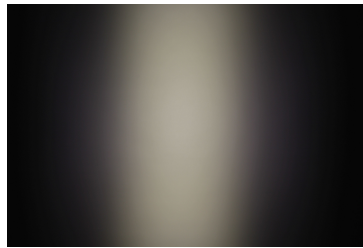

Light distribution files



LED Z5M3
 FWHM / FWTM 18.0 + 53.0° / 44.0 + 84.0°
 Efficiency 93 %
 Peak intensity 2.1 cd/lm
 LEDs/each optic 1
 Light colour/type White
 Required components:

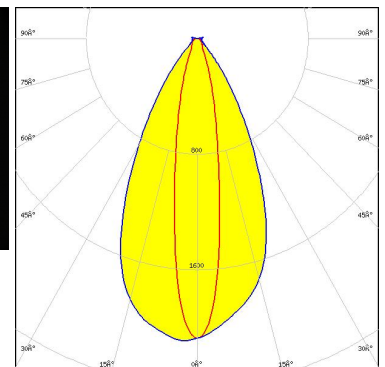
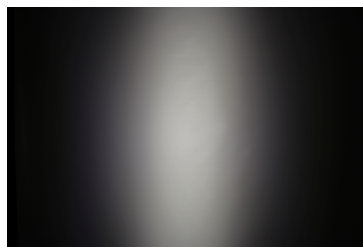

Light distribution files

OPTICAL RESULTS (MEASURED):

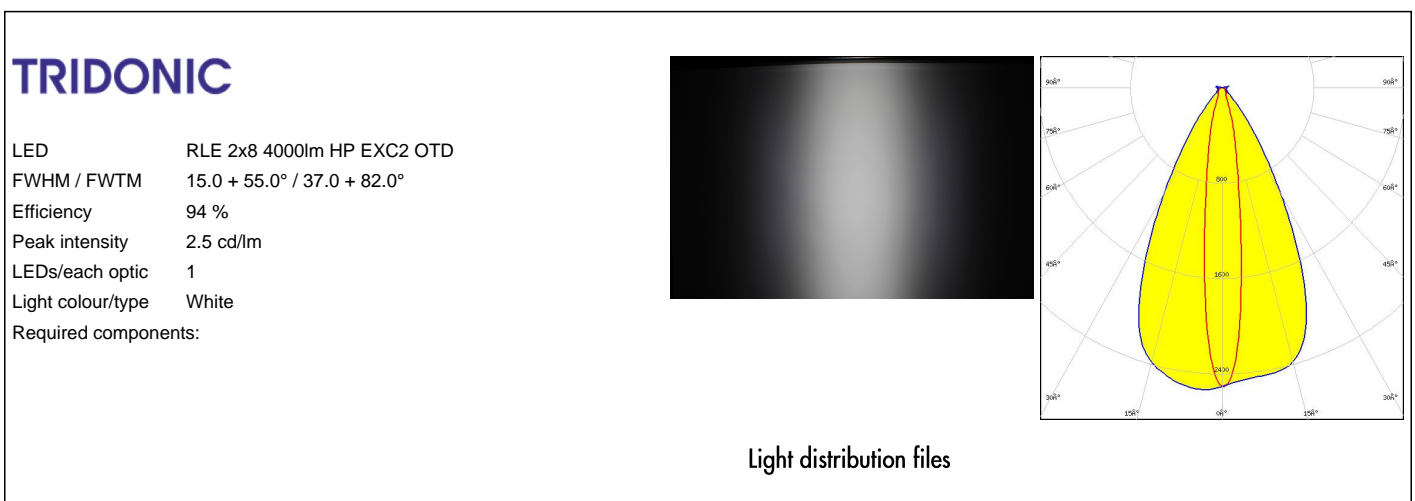
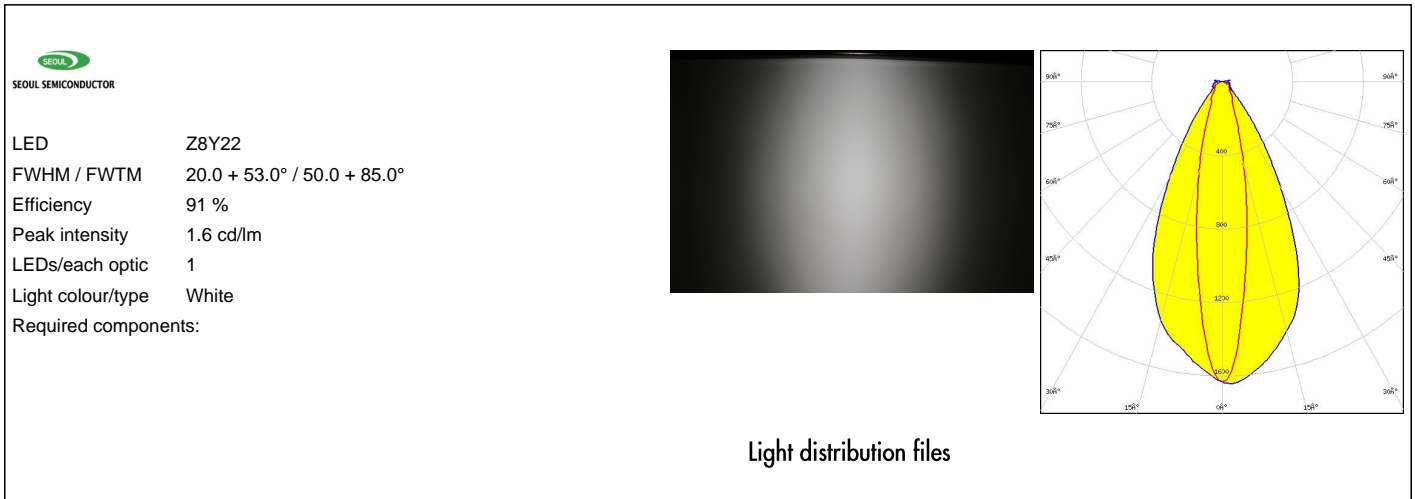

OPTICAL RESULTS (SIMULATED):



LED XHP35 HI
FWHM / FWTM 16.0 + 50.0°
Efficiency 90 %
LEDs/each optic 1
Light colour/type White
Required components:

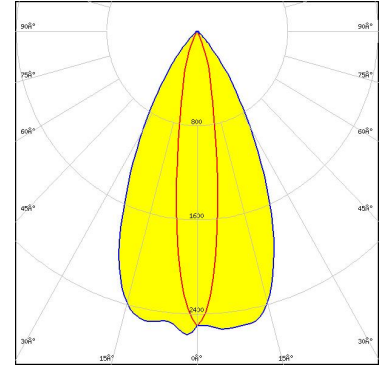

Light distribution files



LED XP-E2
FWHM / FWTM 10.0 + 50.0°
Efficiency 90 %
LEDs/each optic 1
Light colour/type White
Required components:

Light distribution files



LED XP-E2
FWHM / FWTM 54.0 + 10.0° / 78.0 + 27.0°
Efficiency 93 %
Peak intensity 3.8 cd/lm
LEDs/each optic 1
Light colour/type White
Required components:

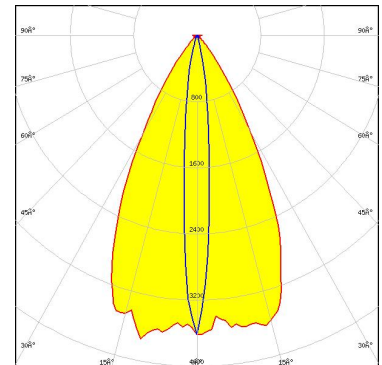

Light distribution files

OPTICAL RESULTS (SIMULATED):



LED XP-G2 HE
FWHM / FWTM 18.0 + 51.0° / 42.0 + 82.0°
Efficiency 90 %
Peak intensity 2.4 cd/lm
LEDs/each optic 1
Light colour/type White
Required components:

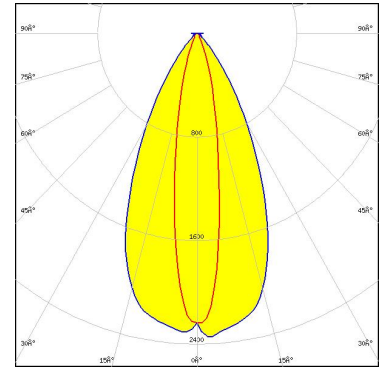

Light distribution files



LED XP-G3
FWHM / FWTM 17.0 + 48.0°
Efficiency 89 %
LEDs/each optic 1
Light colour/type White
Required components:

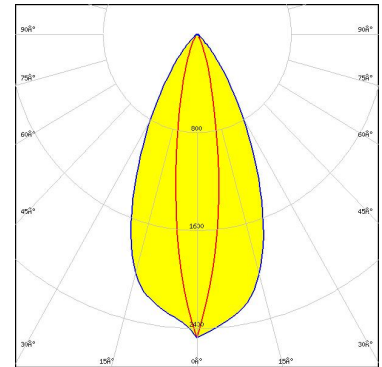

Light distribution files



LED XP-G4
FWHM / FWTM 14.0 + 54.0° / 36.0 + 80.0°
Efficiency 91 %
Peak intensity 2.8 cd/lm
LEDs/each optic 1
Light colour/type White
Required components:

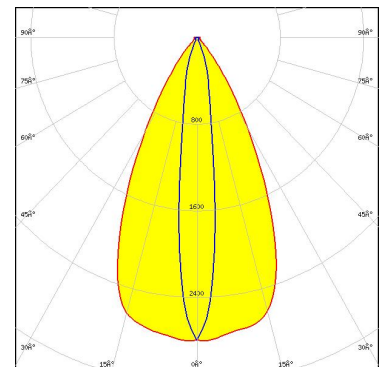

Light distribution files

OPTICAL RESULTS (SIMULATED):



LED XP-L HD
FWHM / FWTM 18.0 + 50.0°
Efficiency 88 %
LEDs/each optic 1
Light colour/type White
Required components:

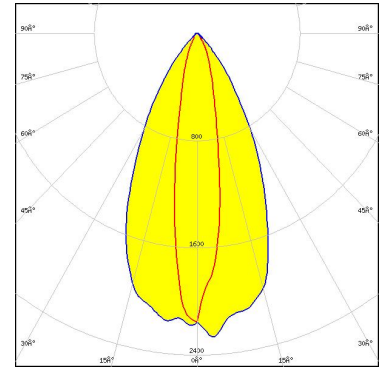

Light distribution files



LED XT-E
FWHM / FWTM 14.0 + 55.0° / 34.0 + 80.0°
Efficiency 91 %
Peak intensity 2.9 cd/lm
LEDs/each optic 1
Light colour/type White
Required components:

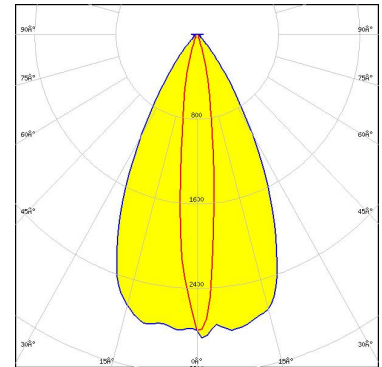

Light distribution files



LED LUXEON 5050 Round LES
FWHM / FWTM 23.0 + 51.0° / 56.0 + 86.0°
Efficiency 89 %
Peak intensity 1.7 cd/lm
LEDs/each optic 1
Light colour/type White
Required components:

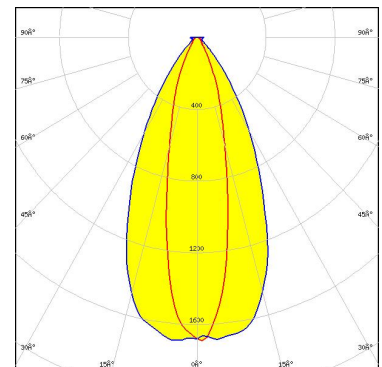

Light distribution files

OPTICAL RESULTS (SIMULATED):



LED LUXEON C
FWHM / FWTM 12.0 + 54.0° / 27.0 + 79.0°
Efficiency 91 %
Peak intensity 3.4 cd/lm
LEDs/each optic 1
Light colour/type White
Required components:

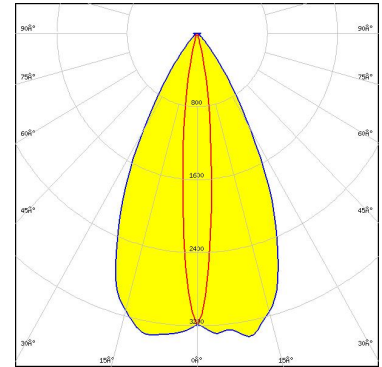

Light distribution files



LED LUXEON HL2X
FWHM / FWTM 18.0 + 52.0° / 42.0 + 82.0°
Efficiency 90 %
Peak intensity 2.3 cd/lm
LEDs/each optic 1
Light colour/type White
Required components:

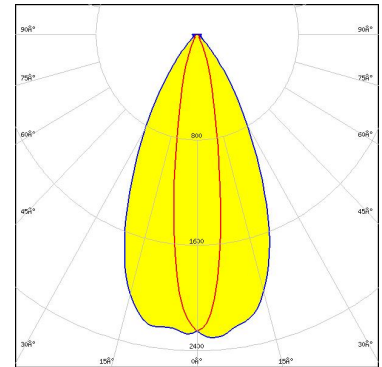

Light distribution files



LED LUXEON HL4X
FWHM / FWTM 20.0 + 50.0° / 46.0 + 84.0°
Efficiency 91 %
Peak intensity 2.1 cd/lm
LEDs/each optic 1
Light colour/type White
Required components:

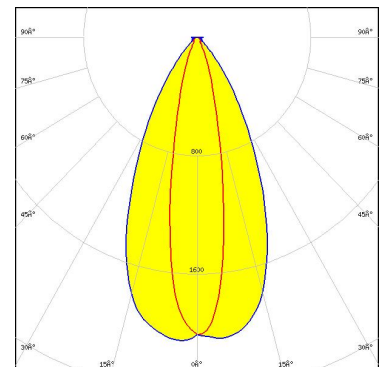

Light distribution files

OPTICAL RESULTS (SIMULATED):



LED LUXEON TX
 FWHM / FWTM 14.0 + 50.0°
 Efficiency 90 %
 LEDs/each optic 1
 Light colour/type White
 Required components:

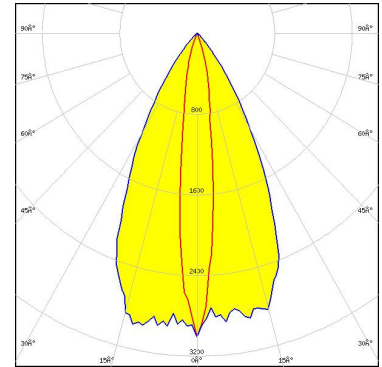

Light distribution files



LED LUXEON XR-HL2X (L2H2-xxxxxxxMLU010)
 FWHM / FWTM 18.0 + 50.0° / 42.0 + 80.0°
 Efficiency 82 %
 Peak intensity 2.1 cd/lm
 LEDs/each optic 1
 Light colour/type White
 Required components:

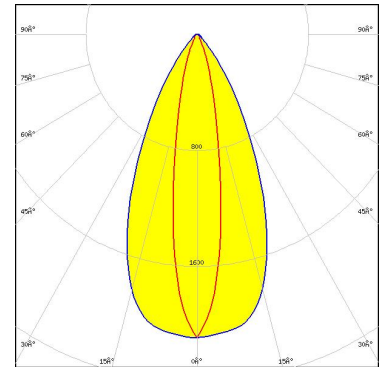

Protective plate, glass

Light distribution files



LED LUXEON XR-HL2X (L2H2-xxxxxxxMLU010)
 FWHM / FWTM 18.0 + 52.0° / 42.0 + 82.0°
 Efficiency 91 %
 Peak intensity 2.3 cd/lm
 LEDs/each optic 1
 Light colour/type White
 Required components:

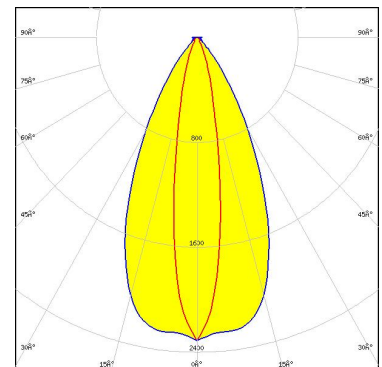

Light distribution files

OPTICAL RESULTS (SIMULATED):

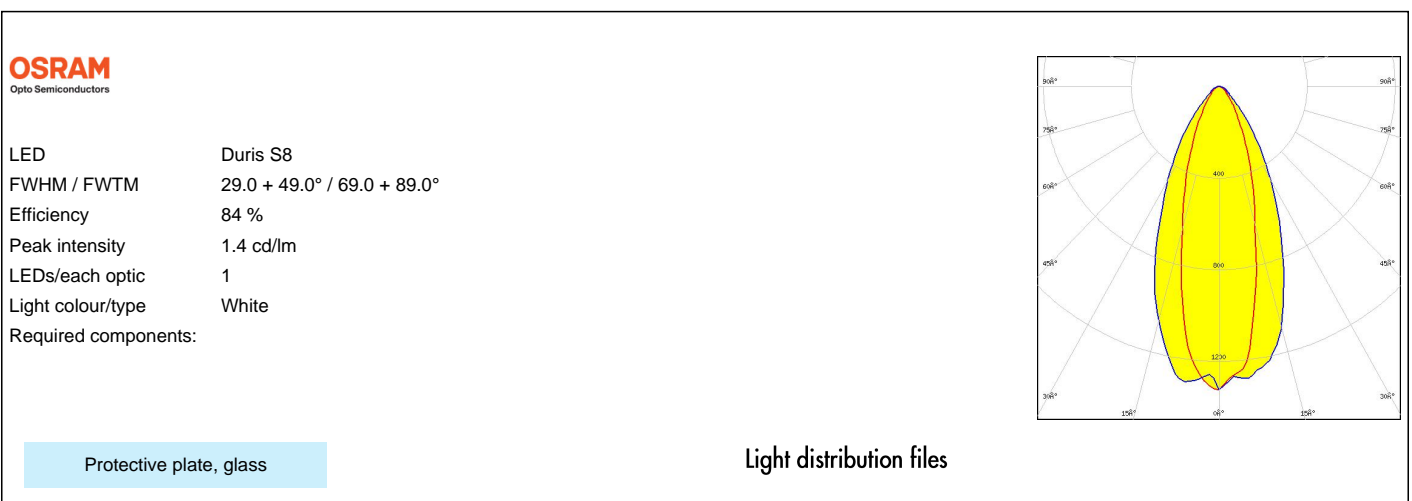
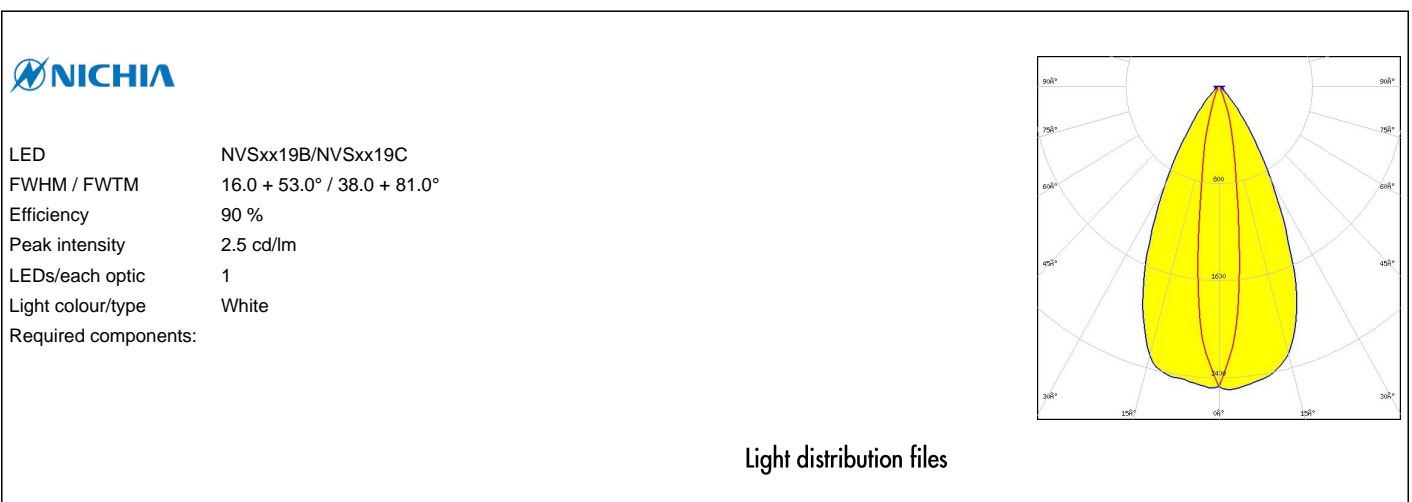

OPTICAL RESULTS (SIMULATED):

OSRAM
Opto Semiconductors

LED Duris S8
FWHM / FWTM 26.0 + 49.0° / 59.0 + 86.0°
Efficiency 88 %
Peak intensity 1.6 cd/lm
LEDs/each optic 1
Light colour/type White
Required components:

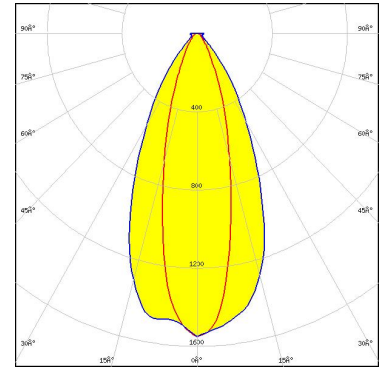

Light distribution files

OSRAM
Opto Semiconductors

LED OSCONIQ C 2424
FWHM / FWTM 12.0 + 54.0° / 30.0 + 78.0°
Efficiency 92 %
Peak intensity 3.3 cd/lm
LEDs/each optic 1
Light colour/type White
Required components:

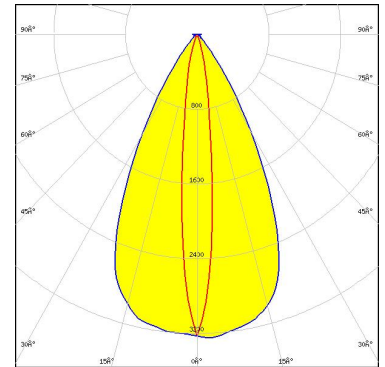

Light distribution files

OSRAM
Opto Semiconductors

LED OSCONIQ P 3030
FWHM / FWTM 10.0 + 56.0° / 28.0 + 78.0°
Efficiency 94 %
Peak intensity 3.5 cd/lm
LEDs/each optic 1
Light colour/type White
Required components:

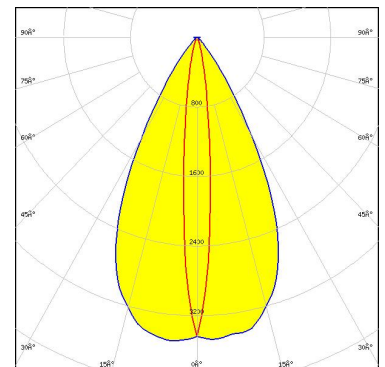

Light distribution files

OPTICAL RESULTS (SIMULATED):

OSRAM
Opto Semiconductors

LED OSCONIQ P 3737 (2W version)
FWHM / FWTM 13.0 + 56.0° / 34.0 + 81.0°
Efficiency 93 %
Peak intensity 2.9 cd/lm
LEDs/each optic 1
Light colour/type White
Required components:

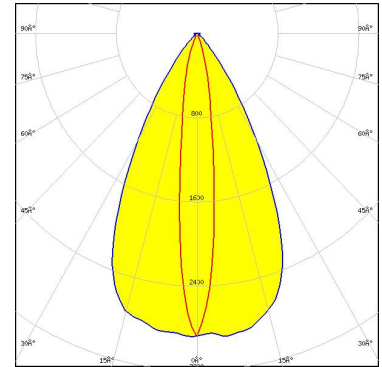

Light distribution files

OSRAM
Opto Semiconductors

LED OSCONIQ P 3737 Flat
FWHM / FWTM 16.0 + 54.0° / 38.0 + 80.0°
Efficiency 92 %
Peak intensity 2.6 cd/lm
LEDs/each optic 1
Light colour/type White
Required components:

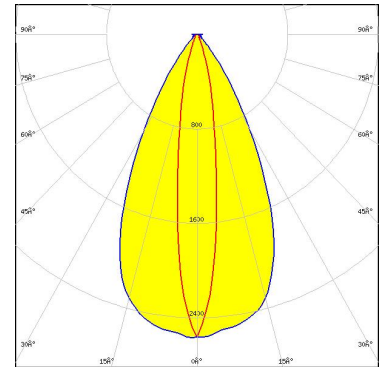

Light distribution files

OSRAM
Opto Semiconductors

LED OSOLON Square Flat
FWHM / FWTM 12.0 + 52.0° / 29.0 + 76.0°
Efficiency 93 %
Peak intensity 3.5 cd/lm
LEDs/each optic 1
Light colour/type White
Required components:

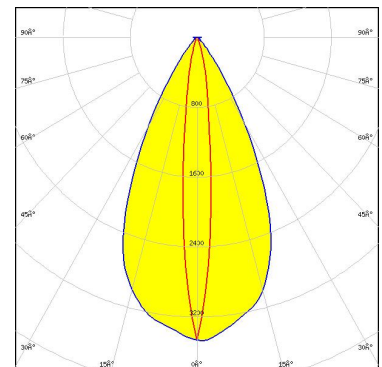

Light distribution files

OPTICAL RESULTS (SIMULATED):

OSRAM
Opto Semiconductors

LED OSTAR Projection Compact (KW.CSLNM1.TG)
FWHM / FWTM 10.0 + 52.0° / 26.0 + 76.0°
Efficiency 93 %
Peak intensity 3.7 cd/lm
LEDs/each optic 1
Light colour/type White
Required components:

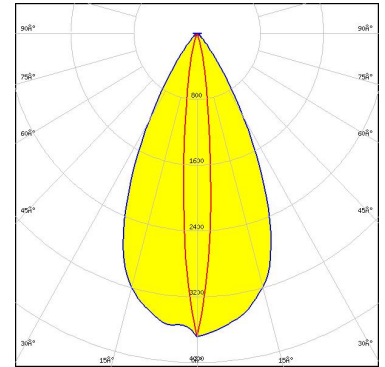

Light distribution files

SAMSUNG

LED LH502C
FWHM / FWTM 28.0 + 50.0° / 64.0 + 86.0°
Efficiency 79 %
Peak intensity 1.4 cd/lm
LEDs/each optic 1
Light colour/type White
Required components:

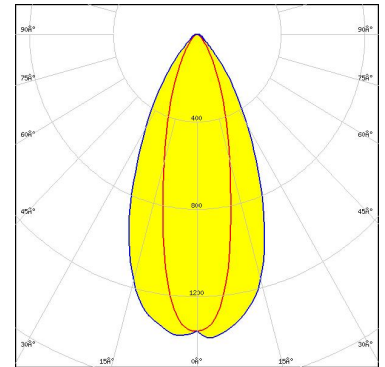

Protective plate, glass

Light distribution files

SAMSUNG

LED LH502C
FWHM / FWTM 26.0 + 50.0° / 64.0 + 86.0°
Efficiency 87 %
Peak intensity 1.5 cd/lm
LEDs/each optic 1
Light colour/type White
Required components:

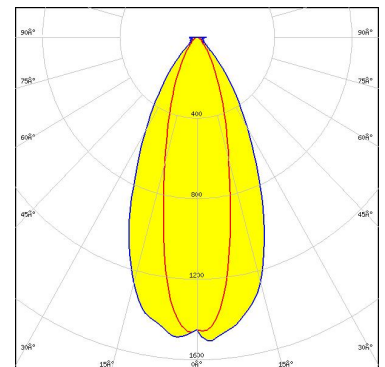

Light distribution files

OPTICAL RESULTS (SIMULATED):

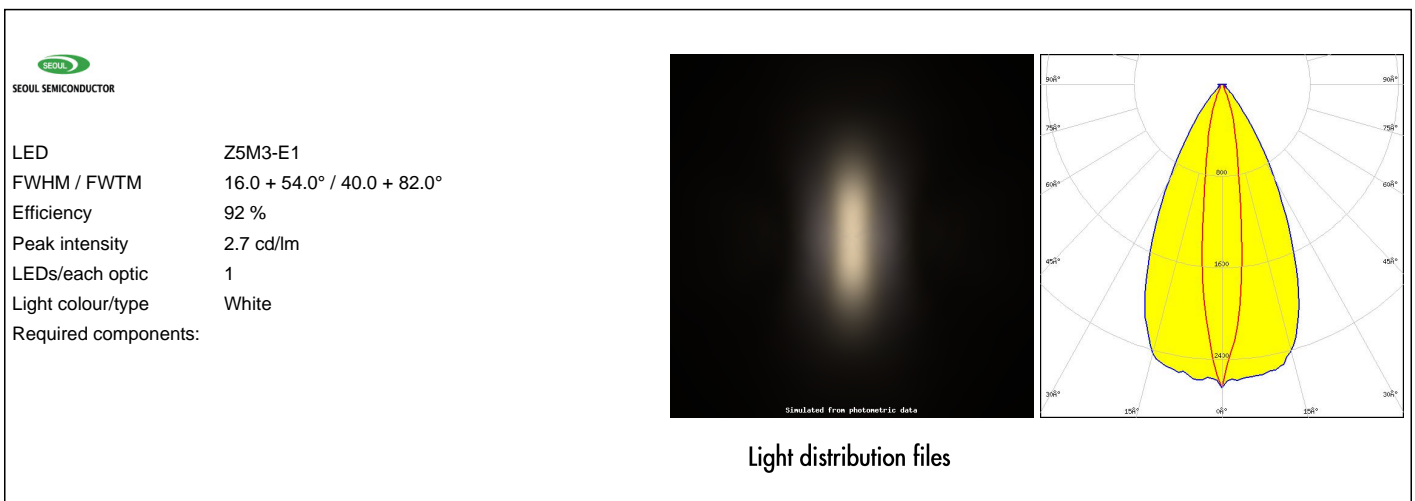
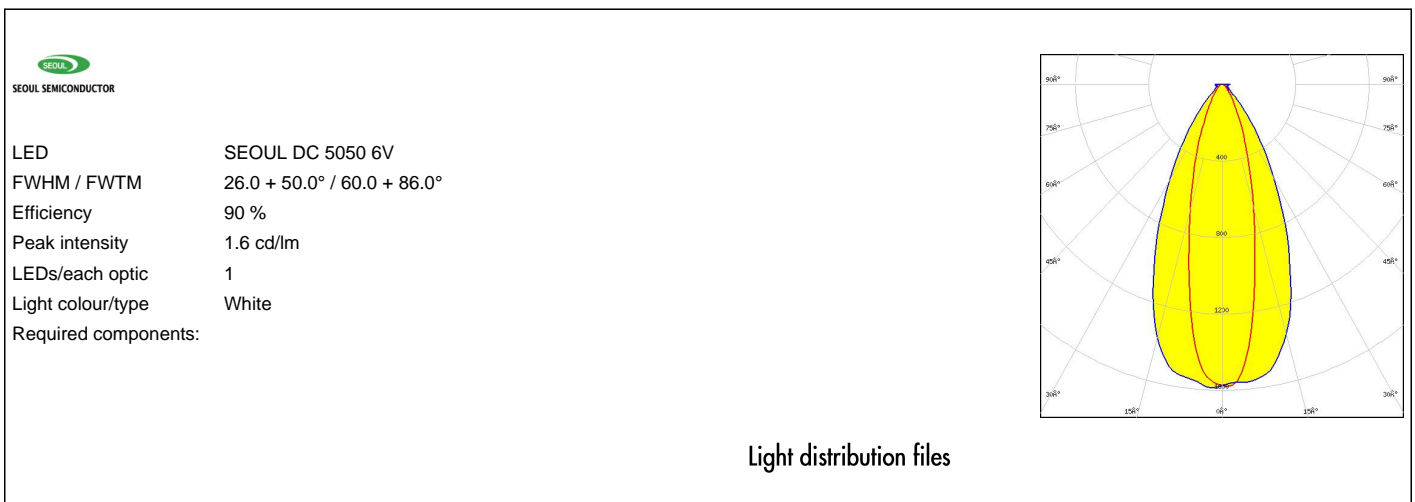
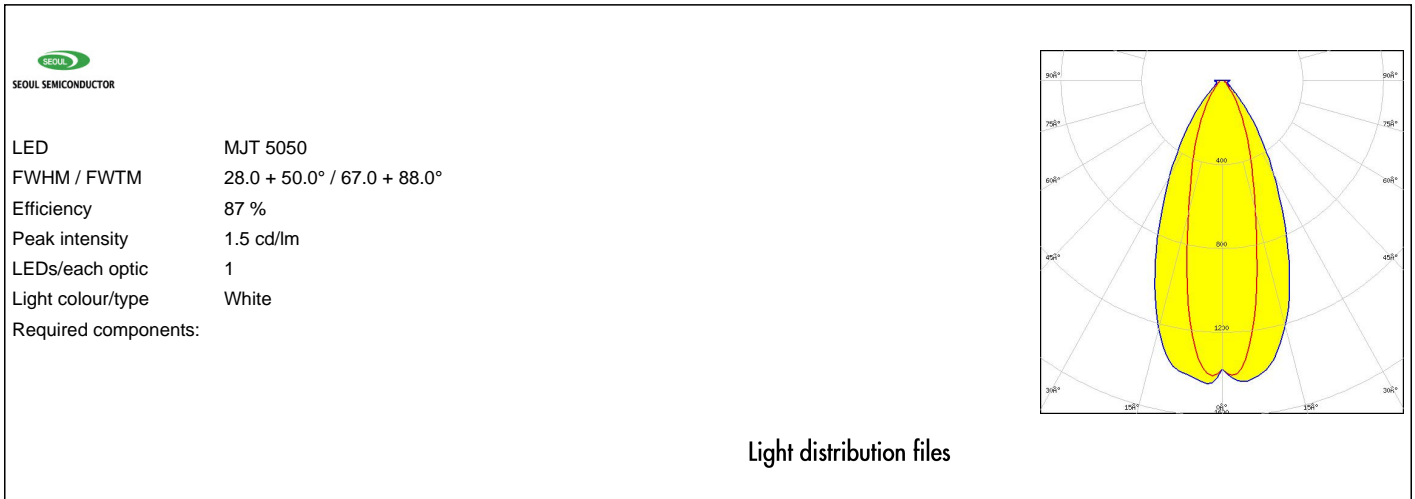

OPTICAL RESULTS (SIMULATED):

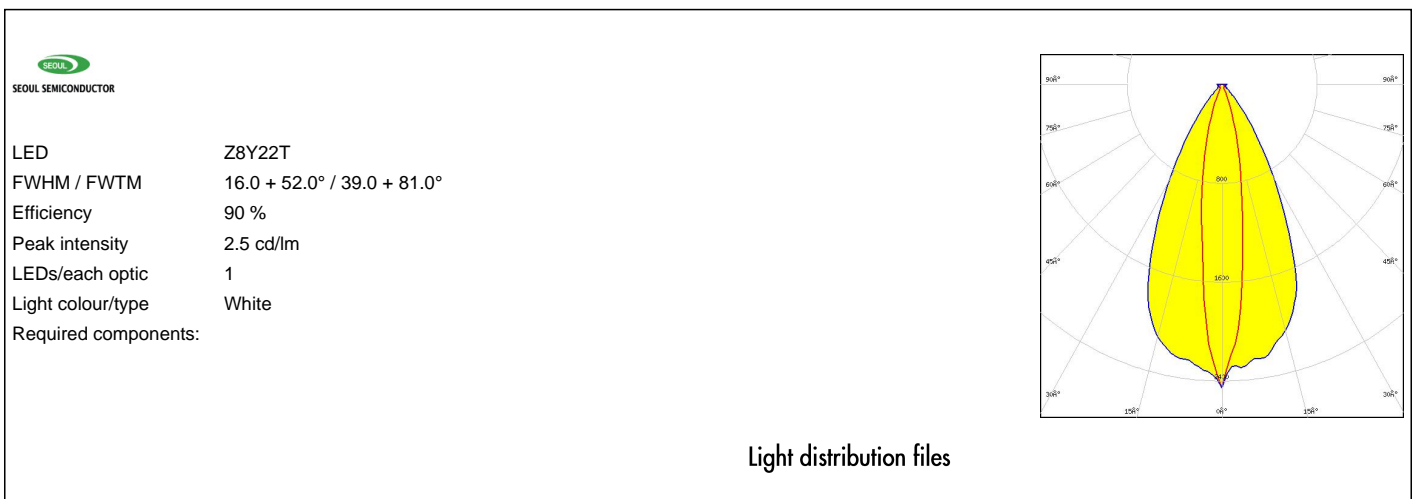
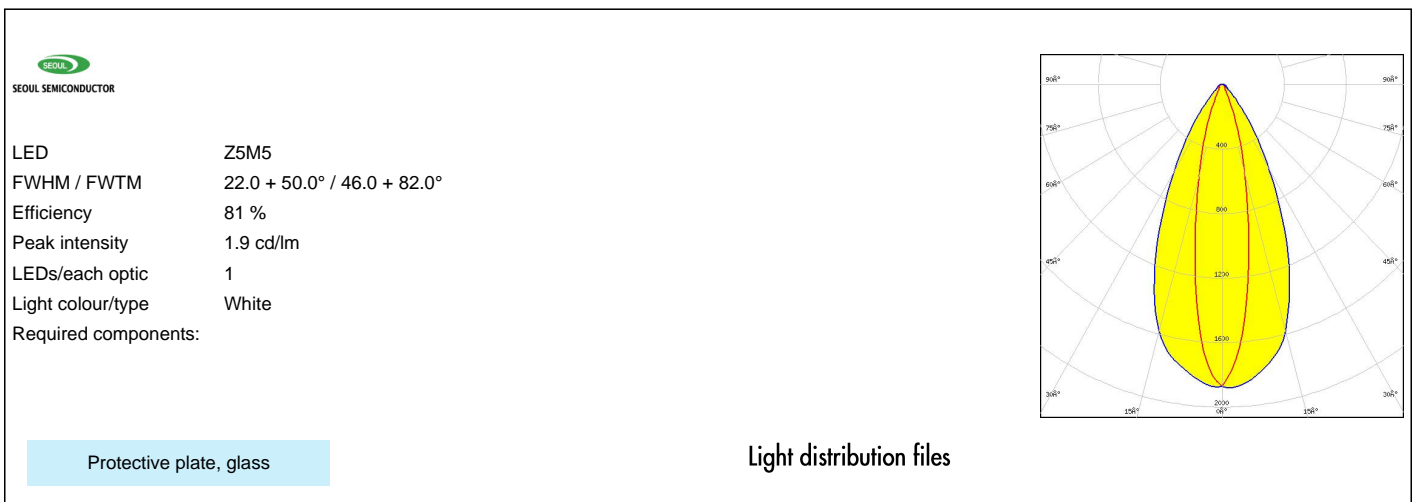
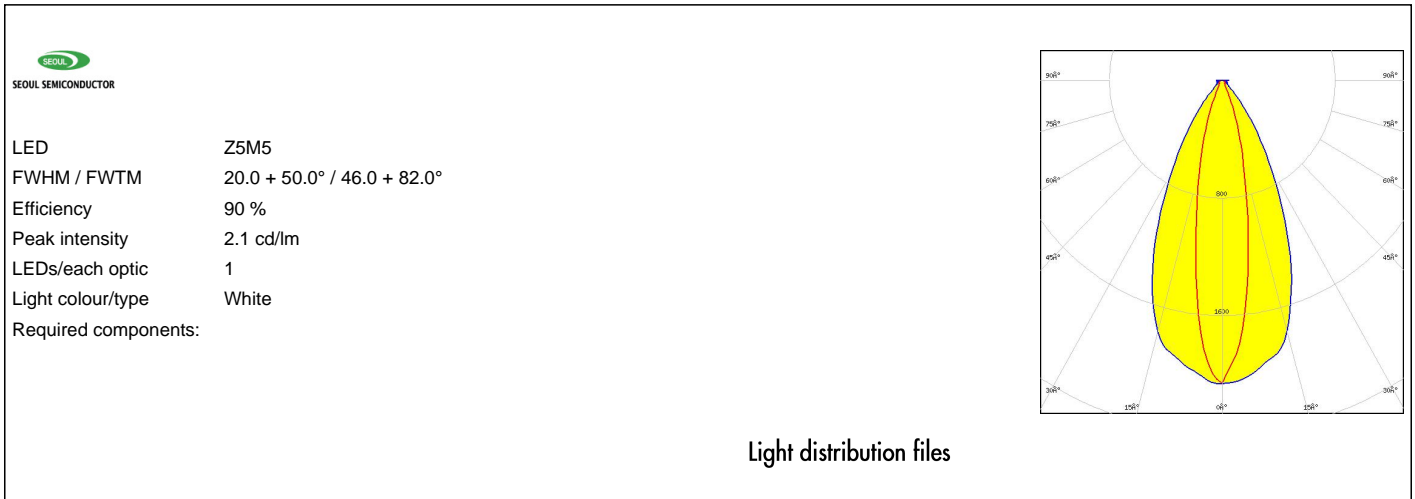

GENERAL INFORMATION:

NOTE: The typical beam angle will be changed by different color, chip size and chip position tolerance. The typical total beam angle is the full angle measured where the luminous intensity is half of the peak value.

MATERIALS:

As part of our continuous research and improvement processes, and to ensure the best possible quality and availability of our products, LEDiL reserves the right to change material grades without notice.

PRODUCT DATA USER AGREEMENT AND DISCLAIMER:

The measured data in the provided downloadable LEDiL Product Datasheets and Mechanical 2D-Drawings is rounded and provided as reference for planning. LEDiL Oy's optical specifications have been verified by conducting performance testing of the products in accordance with the company's quality system. The reported data are averaged results of multiple measurements with typical variation. LEDiL Oy reserves the right to without prior notification make changes and improvements to its products.

LEDiL Oy assumes neither warranty, nor guarantee nor any other liability of any kind for the contents and correctness of the provided data. The provided data has been generated with highest diligence but the provided data may in reality not represent the complete possible variation range of all intrinsic parameters. Therefore, in certain cases a deviation from the provided data could occur.

LEDiL Oy reserves the right to undertake technical changes of its products without further notification which could lead to changes in the provided data. LEDiL Oy assumes no liability of any kind for the possible deviation from any provided data or any other damage resulting from the usage of the provided data.

The user agrees to this disclaimer and user agreement with the download or usage of the provided files.

LEDiL Oy

Joensuunkatu 7
FI-24240 SALO
Finland

LEDiL Inc.

228 West Page Street
Suite D
Sycamore IL 60178
USA

Ledil Optics Technology (Shenzhen) Co., Ltd.

405 , Block B
Casic Motor Building
Shenzhen 518057
P.R.CHINA

Local sales and technical support

[www.ledil.com/
where_to_buy](http://www.ledil.com/where_to_buy)

Shipping locations

Poznan, Poland
Hong Kong, China

Distribution Partners

[www.ledil.com/
where_to_buy](http://www.ledil.com/where_to_buy)