

HB-SQ-WWW

~90° beam. Assembly with installation tape.

SPECIFICATION:

Dimensions	25.0 x 25.0 mm
Height	10 mm
Fastening	tape, pin
ROHS compliant	yes ⓘ

MATERIALS:

Component	Type	Material	Colour	Finish	Length
HB-SQ-WWW	Single lens	PMMA	clear		25.0
ROSE-TAPE	Tape	Acrylic foam	black		21.6

ORDERING INFORMATION:

Component	Qty in box	MOQ	MPQ	Box weight (kg)
CA16372_HB-SQ-WWW » Box size: 480 x 280 x 300 mm	2058	294	98	8.9



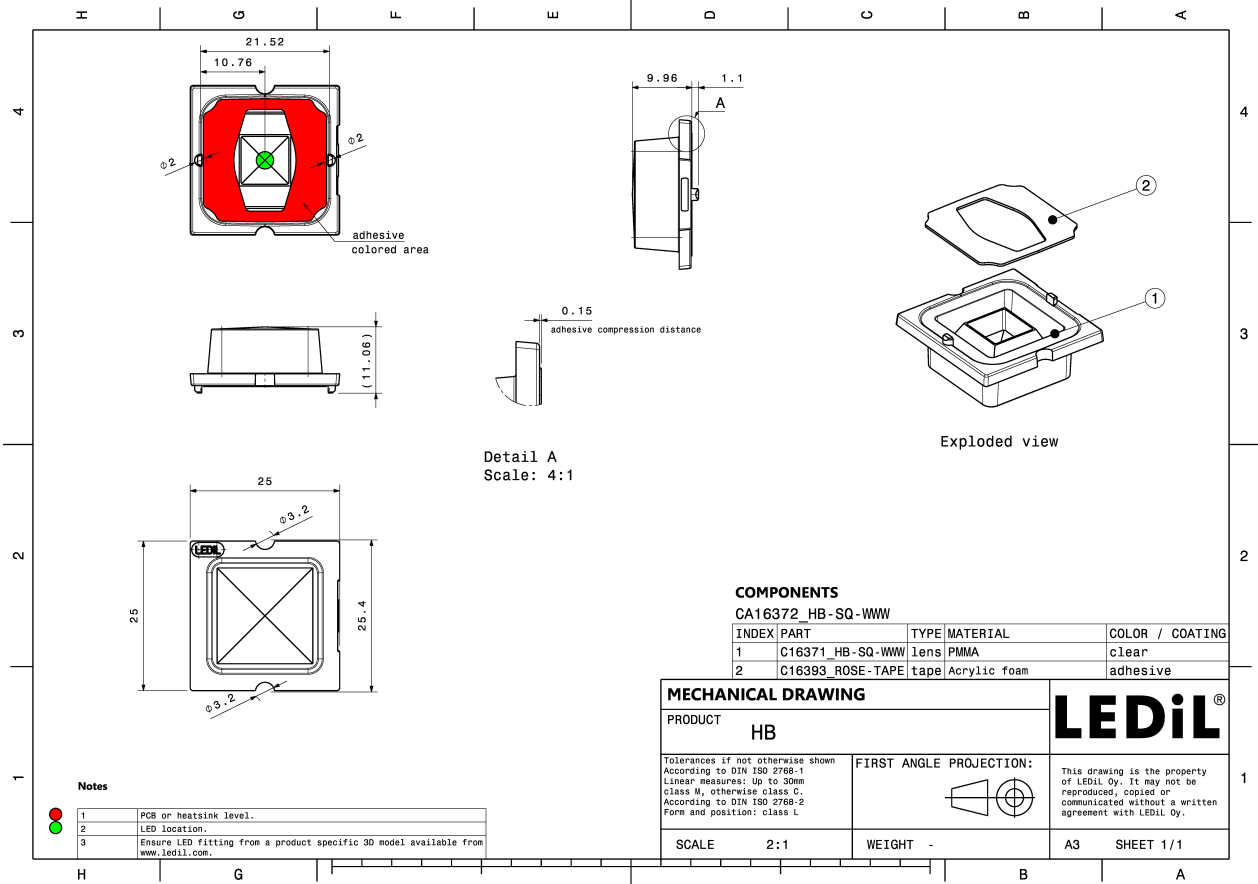

See also our general installation guide: www.ledil.com/installation_guide

OPTICAL RESULTS (MEASURED):



LED XHP70
FWHM / FWTM 88.0° / 122.0°
Efficiency 91 %
Peak intensity 0.4 cd/lm
LEDs/each optic 1
Light colour/type White
Required components:

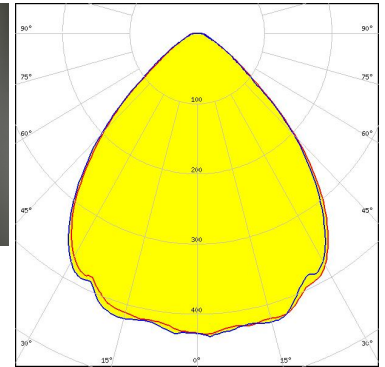
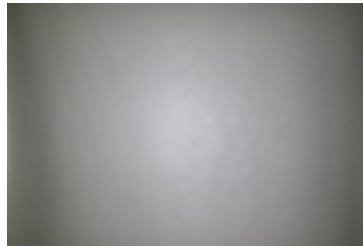

Light distribution files



LED LUXEON 5050 Round LES
FWHM / FWTM 80.0° / 110.0°
Efficiency 93 %
Peak intensity 0.5 cd/lm
LEDs/each optic 1
Light colour/type White
Required components:

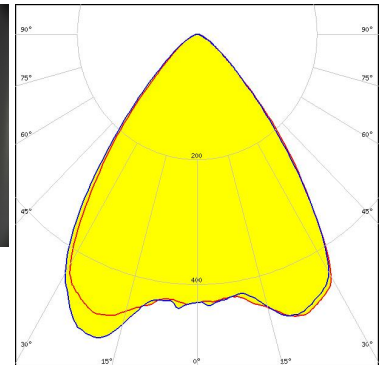

Light distribution files

OPTICAL RESULTS (SIMULATED):

bridgelux

LED	Bridgelux SMD 5050
FWHM / FWTM	77.0° / 108.0°
Efficiency	93 %
Peak intensity	0.5 cd/lm
LEDs/each optic	1
Light colour/type	White
Required components:	

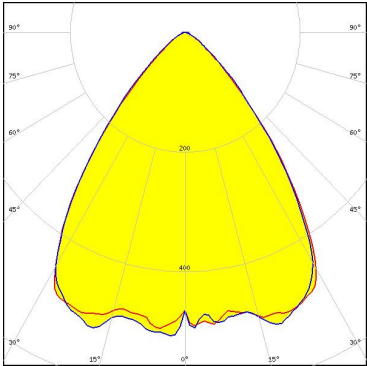

Light distribution files

CREE LEDs

LED	MHD-E/G
FWHM / FWTM	85.5° / 120.0°
Efficiency	91 %
Peak intensity	0.5 cd/lm
LEDs/each optic	1
Light colour/type	White
Required components:	

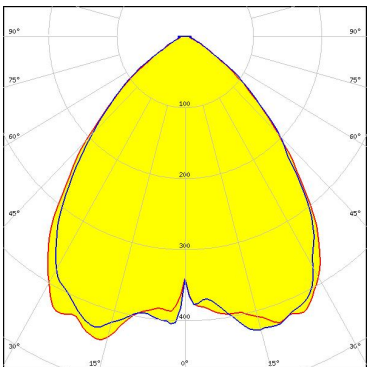

Light distribution files

CREE LEDs

LED	XHP50.2
FWHM / FWTM	86.0° / 120.0°
Efficiency	93 %
Peak intensity	0.4 cd/lm
LEDs/each optic	1
Light colour/type	White
Required components:	

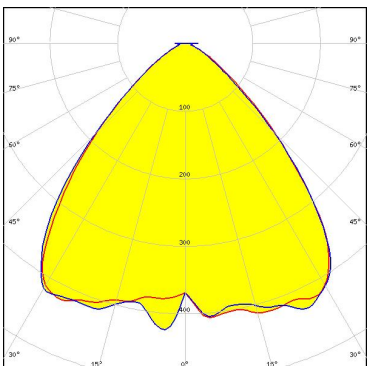

Light distribution files

OPTICAL RESULTS (SIMULATED):



LED XHP70
 FWHM / FWTM 83.0° / 115.0 + 114.0°
 Efficiency 89 %
 Peak intensity 0.5 cd/lm
 LEDs/each optic 1
 Light colour/type White
 Required components:

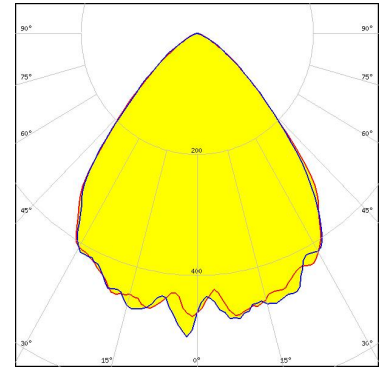

Light distribution files



LED XHP70.2
 FWHM / FWTM 85.0° / 119.0 + 120.0°
 Efficiency 86 %
 Peak intensity 0.4 cd/lm
 LEDs/each optic 1
 Light colour/type White
 Required components:

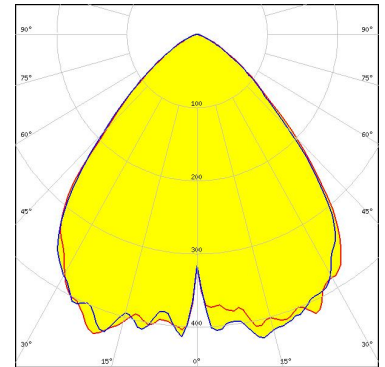

Light distribution files



LED LUXEON 7070
 FWHM / FWTM 74.0° / 108.0°
 Efficiency 92 %
 Peak intensity 0.6 cd/lm
 LEDs/each optic 1
 Light colour/type White
 Required components:

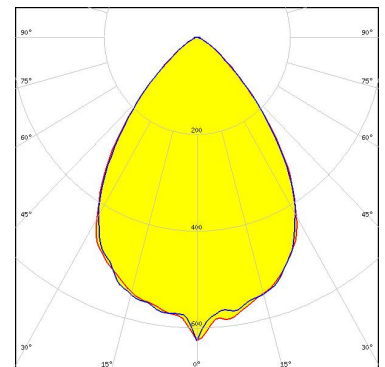

Light distribution files

OPTICAL RESULTS (SIMULATED):



LED LUXEON 7070
FWHM / FWTM 75.0° / 108.0°
Efficiency 83 %
Peak intensity 0.6 cd/lm
LEDs/each optic 1
Light colour/type White
Required components:

Protective plate, glass

Light distribution files

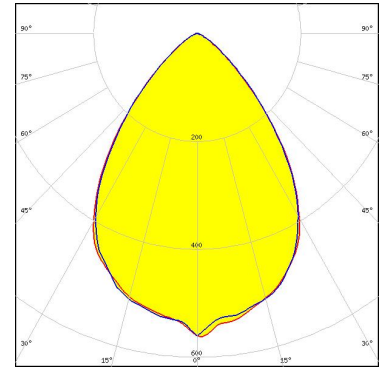

LED LUXEON M/MX
FWHM / FWTM 88.0° / 121.0°
Efficiency 86 %
Peak intensity 0.4 cd/lm
LEDs/each optic 1
Light colour/type White
Required components:

Protective plate, glass

Light distribution files

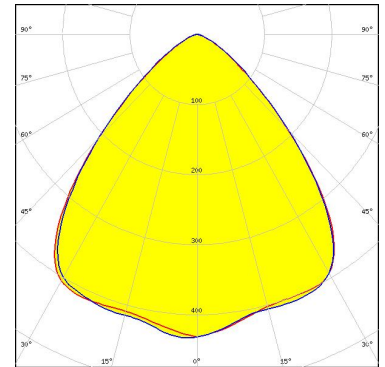

LED LUXEON M/MX
FWHM / FWTM 80.0° / 109.0°
Efficiency 90 %
Peak intensity 0.6 cd/lm
LEDs/each optic 1
Light colour/type White
Required components:

Light distribution files

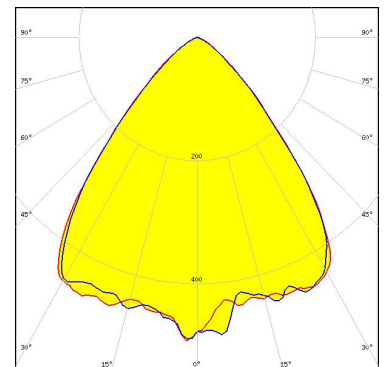

OPTICAL RESULTS (SIMULATED):



LED LUXEON MZ
FWHM / FWTM 77.0° / 107.0°
Efficiency 94 %
Peak intensity 0.6 cd/lm
LEDs/each optic 1
Light colour/type White
Required components:

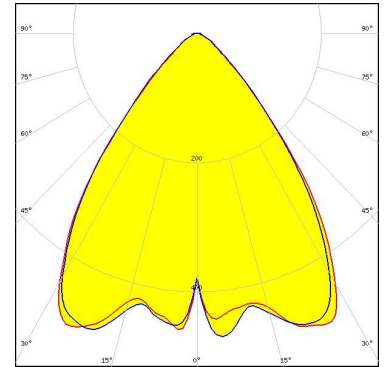

Light distribution files



LED LUXEON V
FWHM / FWTM 81.0° / 111.0°
Efficiency 92 %
Peak intensity 0.5 cd/lm
LEDs/each optic 1
Light colour/type White
Required components:

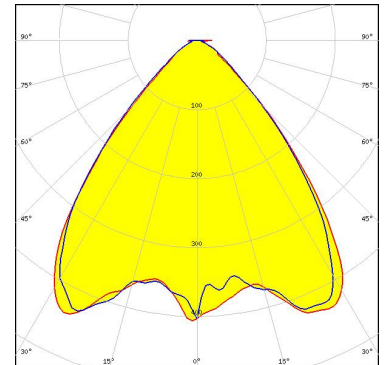

Light distribution files



LED NV4x144A
FWHM / FWTM 86.0° / 121.0°
Efficiency 90 %
Peak intensity 0.4 cd/lm
LEDs/each optic 1
Light colour/type White
Required components:

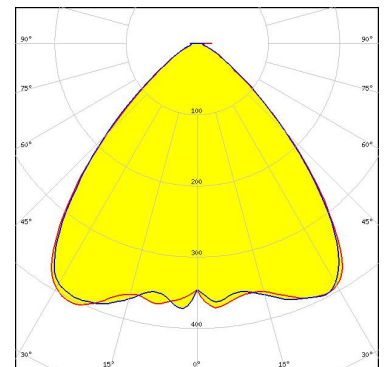

Light distribution files

OPTICAL RESULTS (SIMULATED):

OSRAM
Opto Semiconductors

LED Duris S10
 FWHM / FWTM 74.0° / 107.0°
 Efficiency 95 %
 Peak intensity 0.6 cd/lm
 LEDs/each optic 1
 Light colour/type White
 Required components:

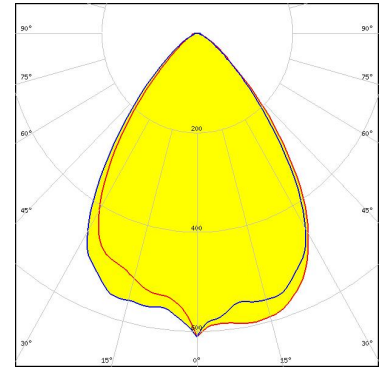

Light distribution files

OSRAM
Opto Semiconductors

LED OSCONIQ C 2424
 FWHM / FWTM 74.0 + 73.0° / 104.0 + 105.0°
 Efficiency 94 %
 Peak intensity 0.7 cd/lm
 LEDs/each optic 4
 Light colour/type White
 Required components:

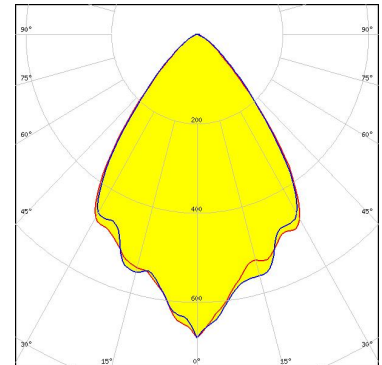

Light distribution files

OSRAM
Opto Semiconductors

LED OSCONIQ P 7070
 FWHM / FWTM 75.0° / 105.0 + 103.0°
 Efficiency 91 %
 Peak intensity 0.6 cd/lm
 LEDs/each optic 1
 Light colour/type White
 Required components:

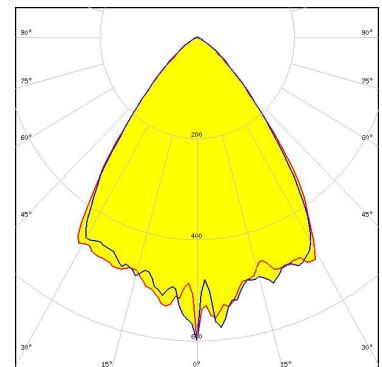

Light distribution files

OPTICAL RESULTS (SIMULATED):

OSRAM
Opto Semiconductors

LED SFH 4715AS
FWHM / FWTM 65.0° / 93.0°
Efficiency 94 %
LEDs/each optic 1
Light colour/type IR
Required components:

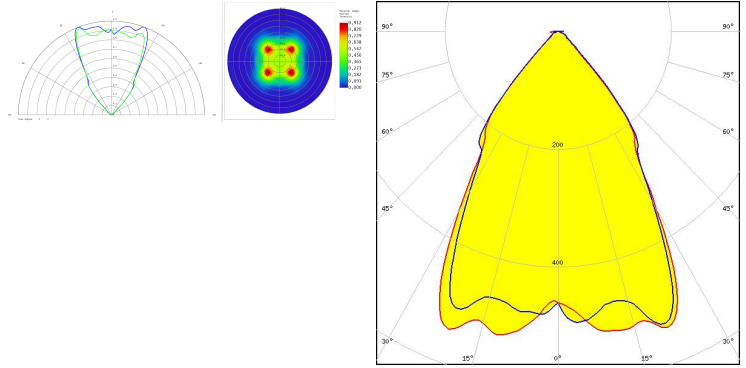

Light distribution files

OSRAM
Opto Semiconductors

LED SFH 4716AS
FWHM / FWTM 76.0° / 100.0°
Efficiency 93 %
LEDs/each optic 1
Light colour/type IR
Required components:

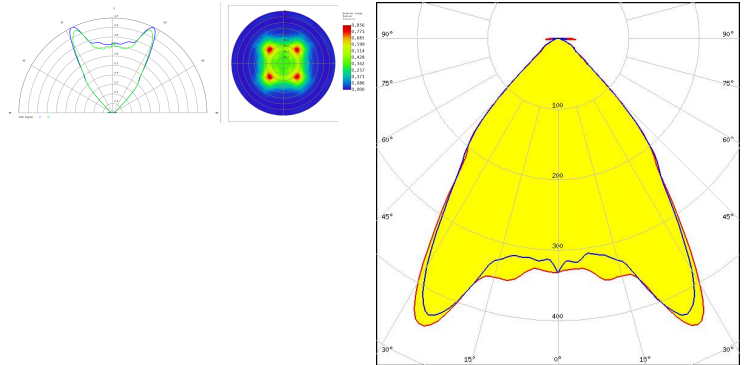

Light distribution files

OSRAM
Opto Semiconductors

LED SFH 4716S
FWHM / FWTM 75.0° / 101.0°
Efficiency 93 %
LEDs/each optic 1
Light colour/type IR
Required components:

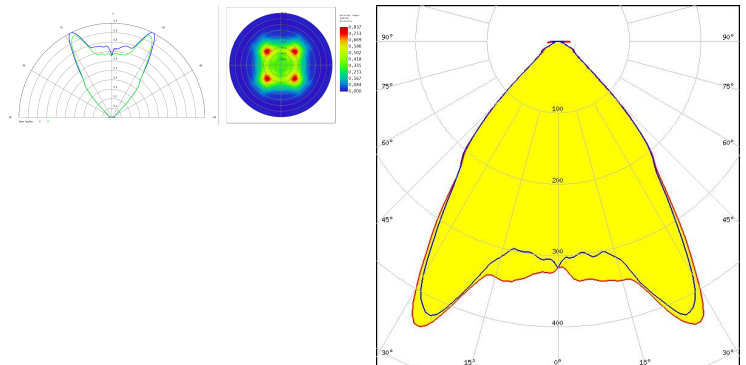

Light distribution files

GENERAL INFORMATION:

NOTE: The typical beam angle will be changed by different color, chip size and chip position tolerance. The typical total beam angle is the full angle measured where the luminous intensity is half of the peak value.

MATERIALS:

As part of our continuous research and improvement processes, and to ensure the best possible quality and availability of our products, LEDiL reserves the right to change material grades without notice.

PRODUCT DATA USER AGREEMENT AND DISCLAIMER:

The measured data in the provided downloadable LEDiL Product Datasheets and Mechanical 2D-Drawings is rounded and provided as reference for planning. LEDiL Oy's optical specifications have been verified by conducting performance testing of the products in accordance with the company's quality system. The reported data are averaged results of multiple measurements with typical variation. LEDiL Oy reserves the right to without prior notification make changes and improvements to its products.

LEDiL Oy assumes neither warranty, nor guarantee nor any other liability of any kind for the contents and correctness of the provided data. The provided data has been generated with highest diligence but the provided data may in reality not represent the complete possible variation range of all intrinsic parameters. Therefore, in certain cases a deviation from the provided data could occur.

LEDiL Oy reserves the right to undertake technical changes of its products without further notification which could lead to changes in the provided data. LEDiL Oy assumes no liability of any kind for the possible deviation from any provided data or any other damage resulting from the usage of the provided data.

The user agrees to this disclaimer and user agreement with the download or usage of the provided files.

LEDiL Oy

Joensuunkatu 13
FI-24240 SALO
Finland

LEDiL Inc.

228 West Page Street
Suite D
Sycamore IL 60178
USA

Ledil Optics Technology (Shenzhen) Co., Ltd.

405 , Block B
Casic Motor Building
Shenzhen 518057
P.R.CHINA

Local sales and technical support

[www.ledil.com/
where_to_buy](http://www.ledil.com/where_to_buy)

Shipping locations

Poznan, Poland
Hong Kong, China

Distribution Partners

[www.ledil.com/
where_to_buy](http://www.ledil.com/where_to_buy)