

## EVA-D

~16° diffused spot beam

### SPECIFICATION:

Dimensions	Ø 35.0 mm
Height	16.4 mm
Fastening	glue
ROHS compliant	yes ⓘ

### MATERIALS:

Component	Type	Material	Colour	Finish	Length (mm)
EVA-D	Single lens	PMMA	clear		



### ORDERING INFORMATION:

Component	Qty in box	MOQ	MPQ	Box weight (kg)
C10684_EVA-D » Box size:	540	90	45	4.0

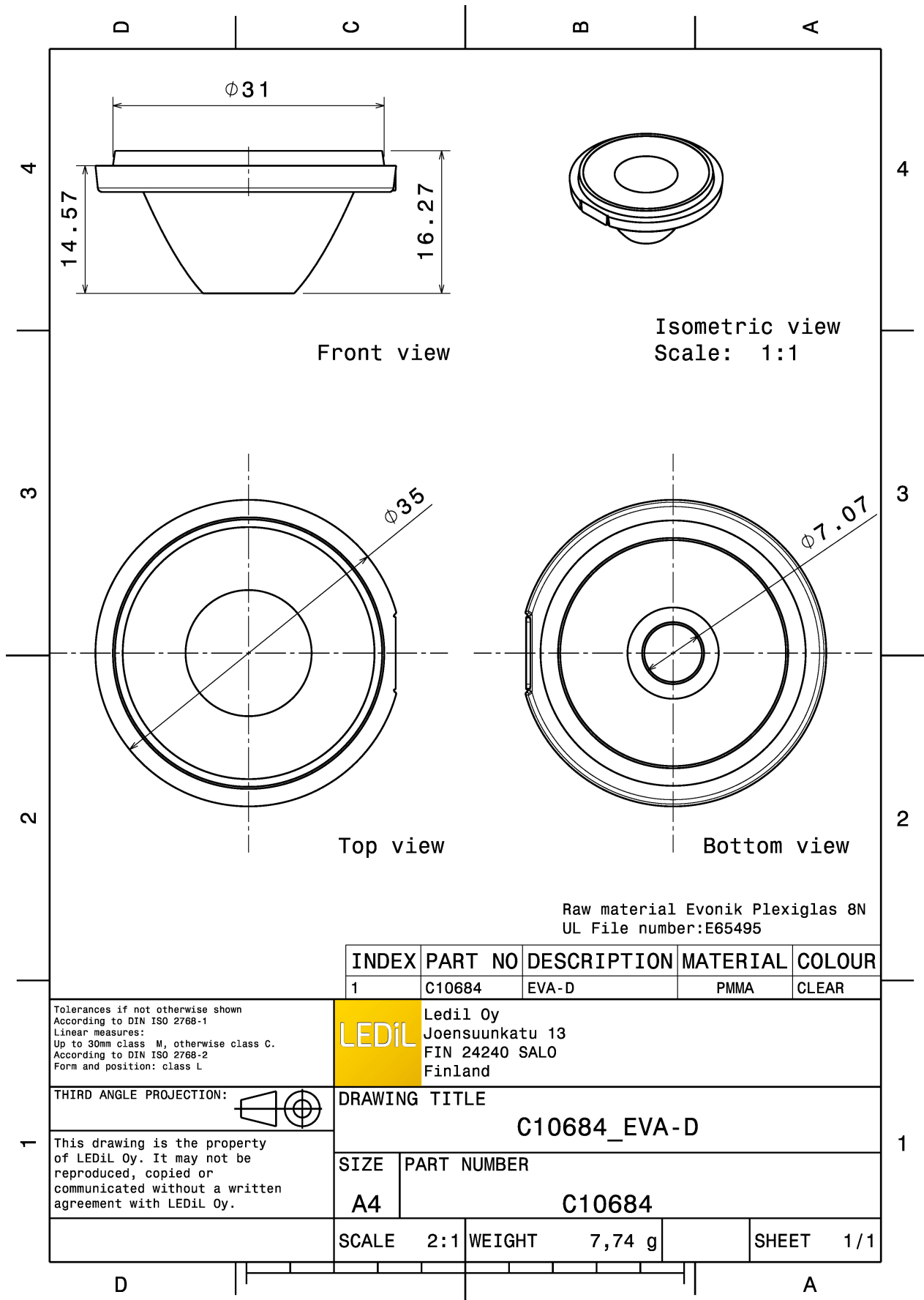

See also our general installation guide: [www.ledil.com/installation\\_guide](http://www.ledil.com/installation_guide)

### OPTICAL RESULTS (MEASURED):

#### CITIZEN

LED CLU7A2/7A3  
 FWHM / FWTM 16.0° / 33.0°  
 Efficiency 92 %  
 Peak intensity 7.5 cd/lm  
 LEDs/each optic 1  
 Light colour/type White  
 Required components:

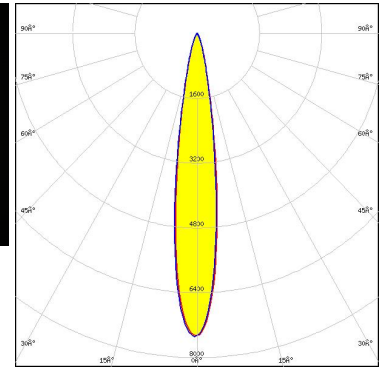

Light distribution files



LED MC-E  
 FWHM / FWTM 16.0°  
 Efficiency 92 %  
 Peak intensity 6 cd/lm  
 LEDs/each optic 1  
 Light colour/type White  
 Required components:

Light distribution files



LED MHB-A/B  
 FWHM / FWTM 19.0° / 40.0°  
 Efficiency 83 %  
 Peak intensity 5.4 cd/lm  
 LEDs/each optic 1  
 Light colour/type White  
 Required components:

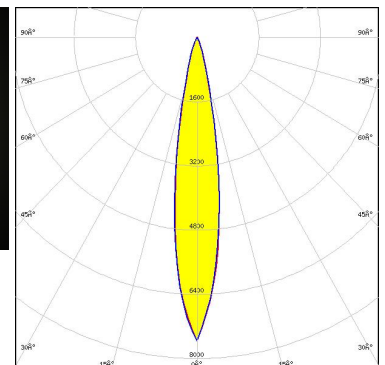
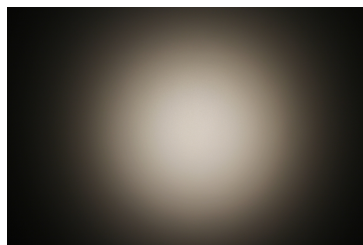

Light distribution files

### OPTICAL RESULTS (MEASURED):



LED XHP35 HI  
FWHM / FWMTM 22.0° / 46.0°  
Efficiency 79 %  
Peak intensity 3.9 cd/lm  
LEDs/each optic 1  
Light colour/type White  
Required components:



[Light distribution files](#)



LED XM-L  
FWHM / FWMTM 16.0°  
Efficiency 91 %  
LEDs/each optic 1  
Light colour/type White  
Required components:

[Light distribution files](#)



LED XP-G2  
FWHM / FWMTM 16.0° / 30.0°  
Efficiency 87 %  
LEDs/each optic 1  
Light colour/type White  
Required components:

[Light distribution files](#)



### OPTICAL RESULTS (MEASURED):



LED XT-E  
 FWHM / FWTM 14.0°  
 Efficiency %  
 Peak intensity 7.5 cd/lm  
 LEDs/each optic 1  
 Light colour/type White  
 Required components:

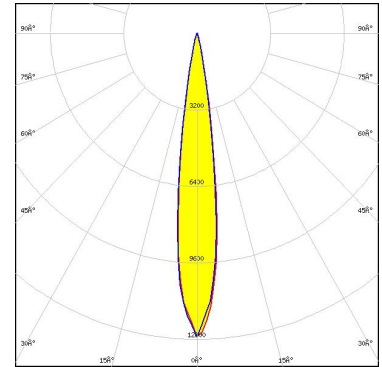

Light distribution files



LED LUXEON 5050 Round LES  
 FWHM / FWTM 18.0° / 35.0°  
 Efficiency 91 %  
 Peak intensity 6.4 cd/lm  
 LEDs/each optic 1  
 Light colour/type White  
 Required components:

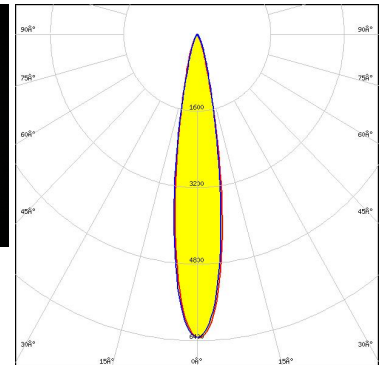

Light distribution files



LED LUXEON M/MX  
 FWHM / FWTM 21.0°  
 Efficiency 90 %  
 Peak intensity 4.2 cd/lm  
 LEDs/each optic 1  
 Light colour/type White  
 Required components:

### OPTICAL RESULTS (MEASURED):



LED LUXEON MZ  
 FWHM / FWTM 16.0° / 33.0°  
 Efficiency 88 %  
 Peak intensity 7.8 cd/lm  
 LEDs/each optic 1  
 Light colour/type White  
 Required components:

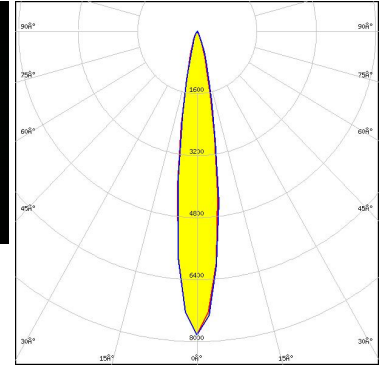

Light distribution files



LED NS9x383  
 FWHM / FWTM 16.0° / 34.0°  
 Efficiency 89 %  
 Peak intensity 6.8 cd/lm  
 LEDs/each optic 1  
 Light colour/type White  
 Required components:

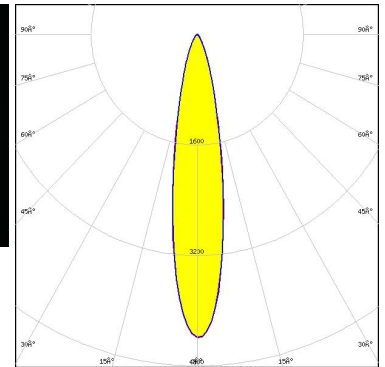

Light distribution files



LED NSMx286M  
 FWHM / FWTM 20.0° / 44.0°  
 Efficiency 91 %  
 Peak intensity 4.4 cd/lm  
 LEDs/each optic 1  
 Light colour/type White  
 Required components:

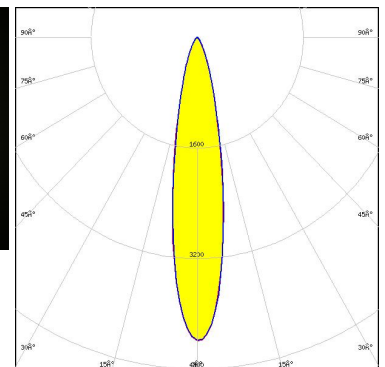
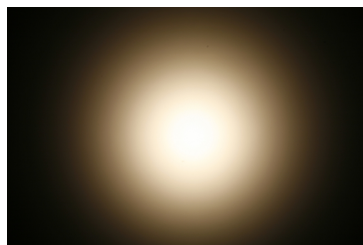

Light distribution files

### OPTICAL RESULTS (MEASURED):

**OSRAM**  
Opto Semiconductors

LED Duris S8  
 FWHM / FWTM 18.0° / 36.0°  
 Efficiency 84 %  
 Peak intensity 6.2 cd/lm  
 LEDs/each optic 1  
 Light colour/type White  
 Required components:

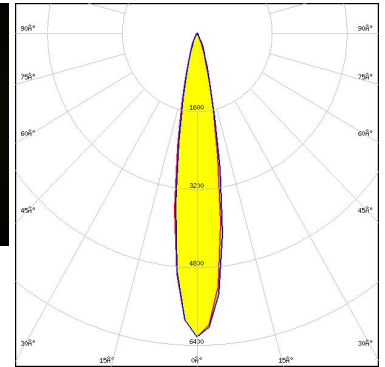

Light distribution files

**SEOL**  
SEOUL SEMICONDUCTOR

LED Z8Y15  
 FWHM / FWTM 13.0° / 28.0°  
 Efficiency 86 %  
 Peak intensity 11.5 cd/lm  
 LEDs/each optic 1  
 Light colour/type White  
 Required components:



Light distribution files

**SEOL**  
SEOUL SEMICONDUCTOR

LED Z8Y19  
 FWHM / FWTM 13.0° / 28.0°  
 Efficiency 87 %  
 Peak intensity 11 cd/lm  
 LEDs/each optic 1  
 Light colour/type White  
 Required components:

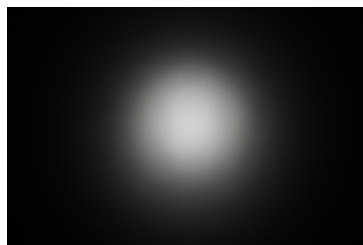

Light distribution files

### OPTICAL RESULTS (SIMULATED):



LED LUXEON 5258  
FWHM / FWTM 17.0° / 30.0°  
Efficiency 92 %  
Peak intensity 8.6 cd/lm  
LEDs/each optic 1  
Light colour/type White  
Required components:

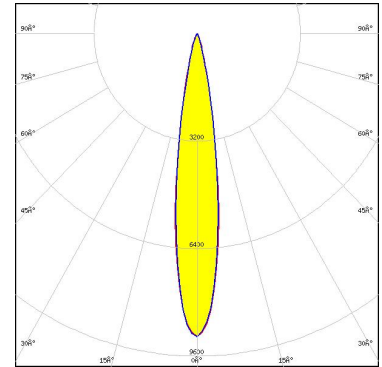

Light distribution files



LED CXM-3  
FWHM / FWTM 14.0° / 26.0°  
Efficiency 95 %  
Peak intensity 11.7 cd/lm  
LEDs/each optic 1  
Light colour/type White  
Required components:



Light distribution files



LED CXM-4  
FWHM / FWTM 18.0° / 34.0°  
Efficiency 95 %  
Peak intensity 7.5 cd/lm  
LEDs/each optic 1  
Light colour/type White  
Required components:

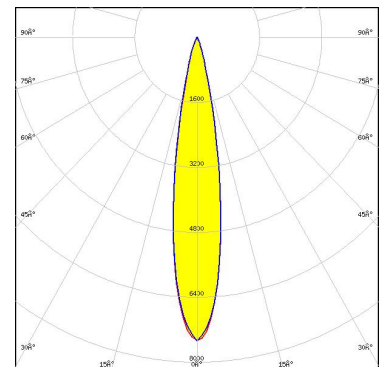

Light distribution files

### OPTICAL RESULTS (SIMULATED):

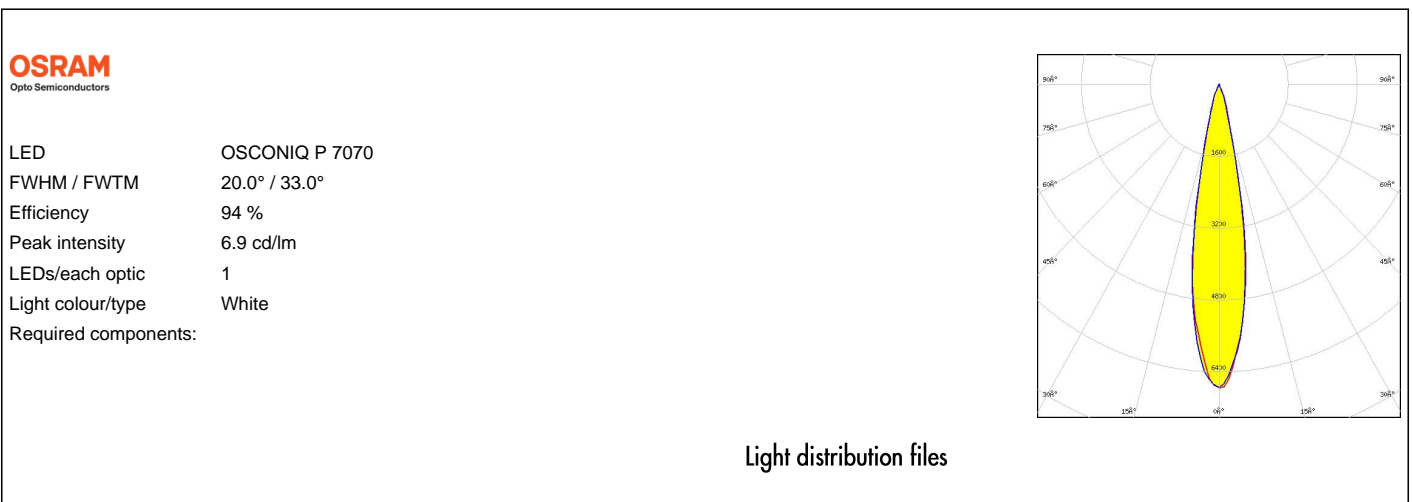
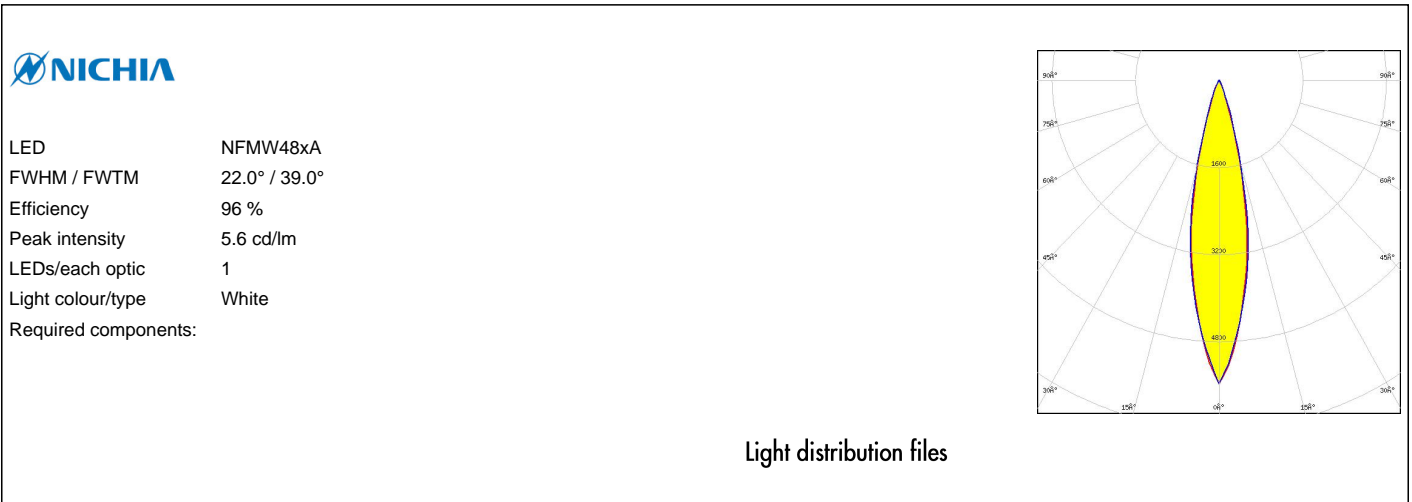

### GENERAL INFORMATION:

NOTE: The typical beam angle will be changed by different color, chip size and chip position tolerance. The typical total beam angle is the full angle measured where the luminous intensity is half of the peak value.

Due to use of high power COB's with this product, special attention to proper thermal design is highly recommended. LEDiL has no liability for direct, indirect or consecutive damages arising from the LEDiL products being used outside of the recommended temperature range.

### MATERIALS:

As part of our continuous research and improvement processes, and to ensure the best possible quality and availability of our products, LEDiL reserves the right to change material grades without notice.

### PRODUCT DATA USER AGREEMENT AND DISCLAIMER:

The measured data in the provided downloadable LEDiL Product Datasheets and Mechanical 2D-Drawings is rounded and provided as reference for planning. LEDiL Oy's optical specifications have been verified by conducting performance testing of the products in accordance with the company's quality system. The reported data are averaged results of multiple measurements with typical variation. LEDiL Oy reserves the right to without prior notification make changes and improvements to its products.

LEDiL Oy assumes neither warranty, nor guarantee nor any other liability of any kind for the contents and correctness of the provided data. The provided data has been generated with highest diligence but the provided data may in reality not represent the complete possible variation range of all intrinsic parameters. Therefore, in certain cases a deviation from the provided data could occur.

LEDiL Oy reserves the right to undertake technical changes of its products without further notification which could lead to changes in the provided data. LEDiL Oy assumes no liability of any kind for the possible deviation from any provided data or any other damage resulting from the usage of the provided data.

The user agrees to this disclaimer and user agreement with the download or usage of the provided files.

#### LEDiL Oy

Joensuunkatu 13  
FI-24240 SALO  
Finland

#### LEDiL Inc.

228 West Page Street  
Suite D  
Sycamore IL 60178  
USA

#### Ledil Optics Technology (Shenzhen) Co., Ltd.

# 405 , Block B  
Casic Motor Building  
Shenzhen 518057  
P.R.CHINA

#### Local sales and technical support

[www.ledil.com/  
where\\_to\\_buy](http://www.ledil.com/where_to_buy)

#### Shipping locations

Poznan, Poland  
Hong Kong, China

#### Distribution Partners

[www.ledil.com/  
where\\_to\\_buy](http://www.ledil.com/where_to_buy)