

## STELLA-VSM

IESNA Type V (square) for wide areas lighting such as car parks. Compatible with up to 30 mm LES size COBs. Variant with black frame.

### SPECIFICATION:

Dimensions	Ø 90.0 mm
Height	20.7 mm
Fastening	screw
Ingress protection classes	IP67
ROHS compliant	yes ⓘ



### MATERIALS:

Component	Type	Material	Colour	Finish	Length
STELLA-VSM	Single lens	Silicone	clear		85.0
STELLA-FRAME	Holder	PA66	black		90.0

### ORDERING INFORMATION:

Component		Qty in box	MOQ	MPQ	Box weight (kg)
FN15379_STELLA-VSM	Single lens	135	135	15	9.2
» Box size: 480 x 280 x 300 mm					

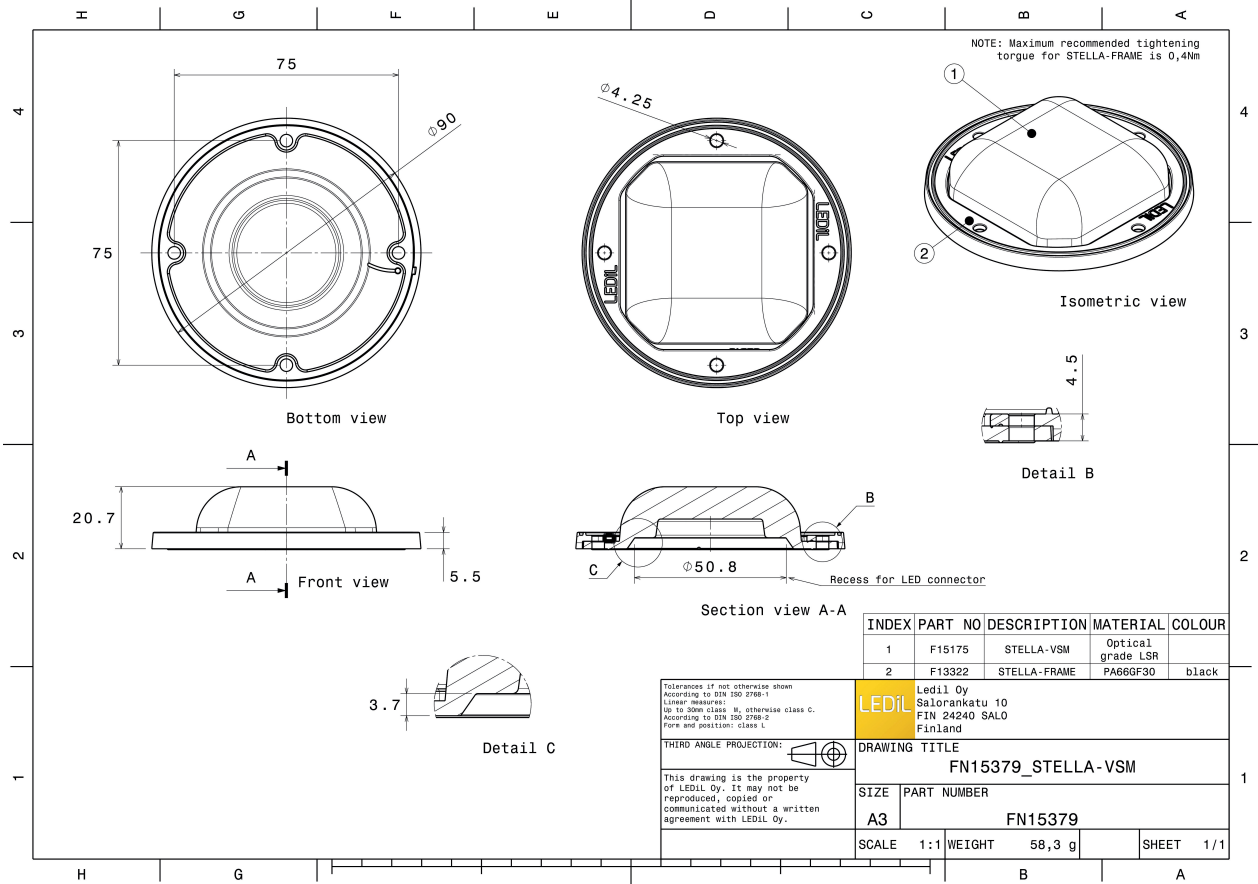

See also our general installation guide: [www.ledil.com/installation\\_guide](http://www.ledil.com/installation_guide)

### OPTICAL RESULTS (MEASURED):

bridgelux

LED V18 Gen7  
 FWHM / FWTM Asymmetric  
 Efficiency 94 %  
 Peak intensity 0.4 cd/lm  
 LEDs/each optic 1  
 Light colour/type White  
 Required components:  
 Bender Wirth: 439 Typ L3

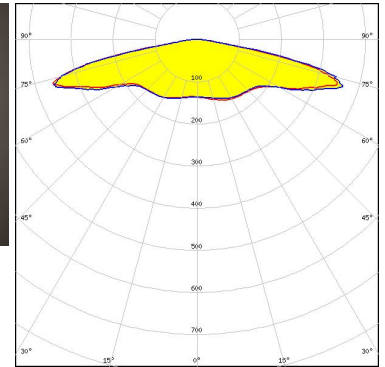
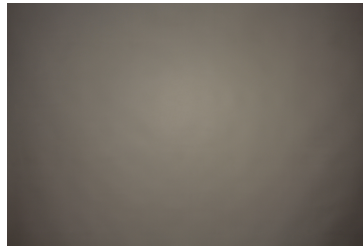

Light distribution files

bridgelux

LED V22 Gen7  
 FWHM / FWTM Asymmetric  
 Efficiency 93 %  
 Peak intensity 0.3 cd/lm  
 LEDs/each optic 1  
 Light colour/type White  
 Required components:

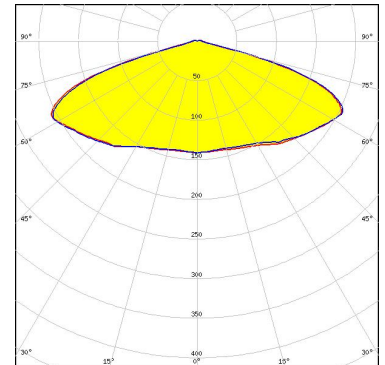

Light distribution files

bridgelux

LED V22 Gen7  
 FWHM / FWTM Asymmetric  
 Efficiency 94 %  
 Peak intensity 0.3 cd/lm  
 LEDs/each optic 1  
 Light colour/type White  
 Required components:  
 Bender Wirth: 431 Typ Z1

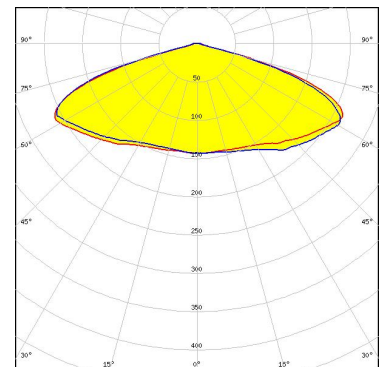

Light distribution files

#### OPTICAL RESULTS (MEASURED):



**LED** V22 Gen7  
**FWHM / FWTM** Asymmetric  
**Efficiency** 94 %  
**Peak intensity** 0.3 cd/lm  
**LEDs/each optic** 1  
**Light colour/type** White  
**Required components:**  
 TE Connectivity: 2213480-1

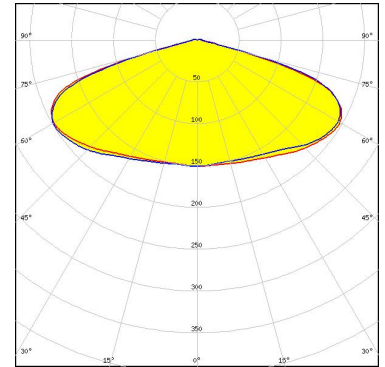

Light distribution files



**LED** Vero SE 18  
**FWHM / FWTM** Asymmetric  
**Efficiency** 94 %  
**Peak intensity** 0.4 cd/lm  
**LEDs/each optic** 1  
**Light colour/type** White  
**Required components:**

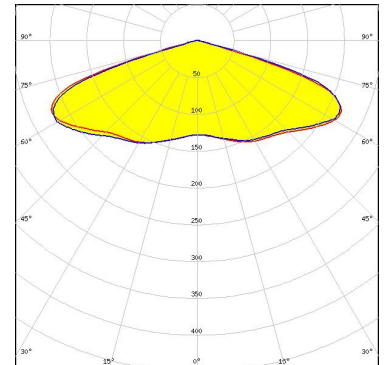

Light distribution files



**LED** Vero SE 29  
**FWHM / FWTM** Asymmetric  
**Efficiency** 94 %  
**Peak intensity** 0.3 cd/lm  
**LEDs/each optic** 1  
**Light colour/type** White  
**Required components:**

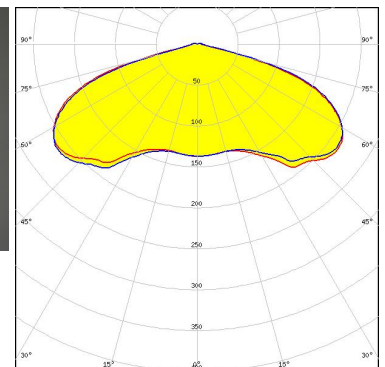
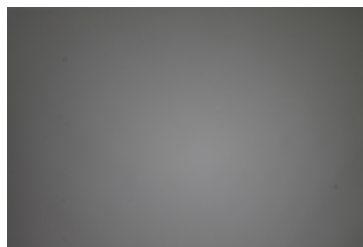

Light distribution files



### OPTICAL RESULTS (MEASURED):



LED VERO13  
FWHM / FWTM Asymmetric  
Efficiency 93 %  
Peak intensity 0.6 cd/lm  
LEDs/each optic 1  
Light colour/type White  
Required components:

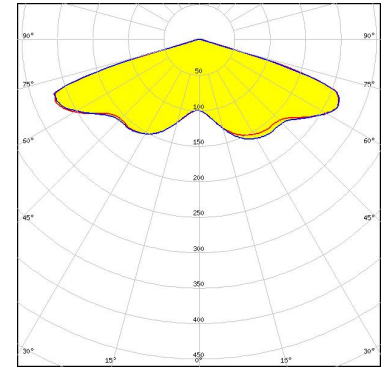

Light distribution files



LED VERO18  
FWHM / FWTM Asymmetric  
Efficiency 94 %  
Peak intensity 0.4 cd/lm  
LEDs/each optic 1  
Light colour/type White  
Required components:

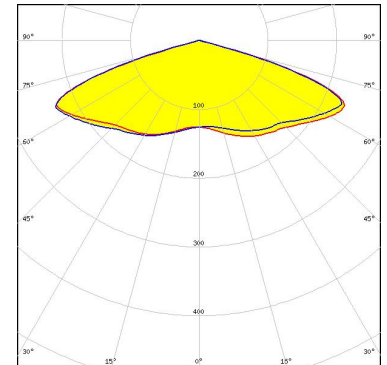

Light distribution files

## CITIZEN

LED CLL05x/CLU05x  
FWHM / FWTM Asymmetric  
Efficiency 94 %  
Peak intensity 0.3 cd/lm  
LEDs/each optic 1  
Light colour/type White  
Required components:

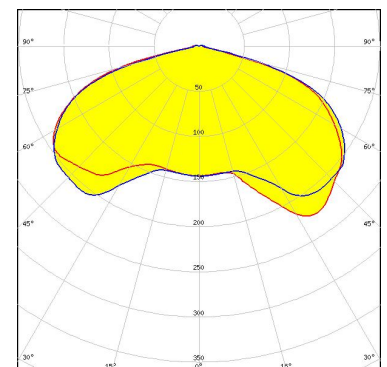

Light distribution files

### OPTICAL RESULTS (MEASURED):



LED CMA2550  
FWHM / FWTM Asymmetric  
Efficiency 94 %  
Peak intensity 0.4 cd/lm  
LEDs/each optic 1  
Light colour/type White  
Required components:

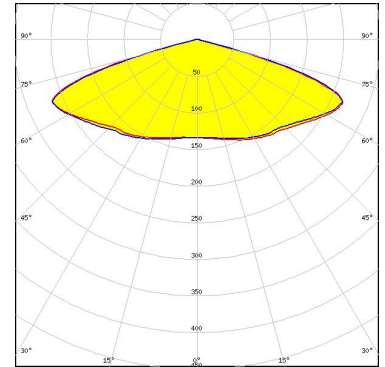

Light distribution files



LED CMT19xx  
FWHM / FWTM Asymmetric  
Efficiency 94 %  
Peak intensity 0.5 cd/lm  
LEDs/each optic 1  
Light colour/type White  
Required components:  
Bender Wirth: 477 Typ Z1

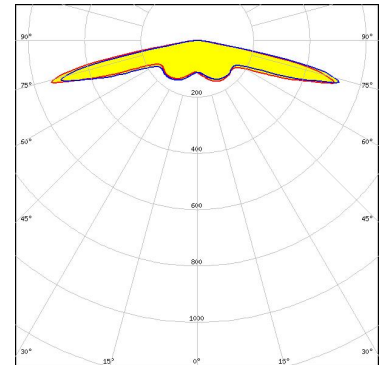

Light distribution files



LED CXA/B 1816 & CXA/B 1820 & CXA 1850  
FWHM / FWTM Asymmetric  
Efficiency 93 %  
Peak intensity 0.6 cd/lm  
LEDs/each optic 1  
Light colour/type White  
Required components:

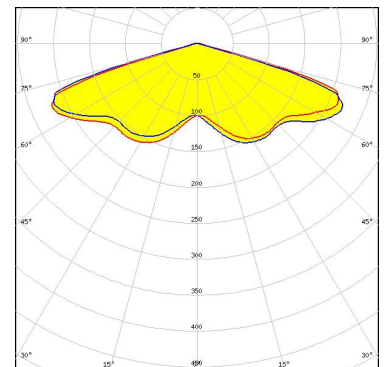

Light distribution files

### OPTICAL RESULTS (MEASURED):



LED CXA/B 25xx  
FWHM / FWTM Asymmetric  
Efficiency 94 %  
Peak intensity 0.3 cd/lm  
LEDs/each optic 1  
Light colour/type White  
Required components:  
Bender Wirth: 439 Typ L3

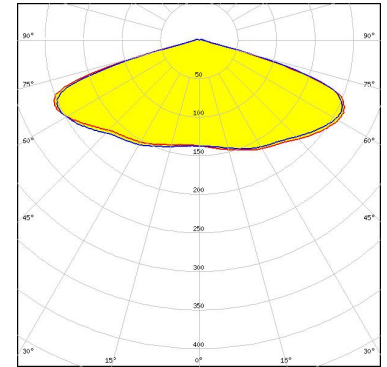

Light distribution files



LED CXA/B 3590  
FWHM / FWTM Asymmetric  
Efficiency 94 %  
Peak intensity 0.3 cd/lm  
LEDs/each optic 1  
Light colour/type White  
Required components:

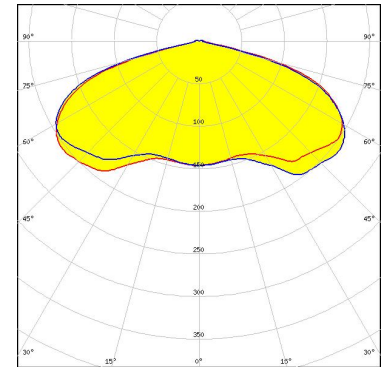

Light distribution files



LED LUXEON CoB 1208  
FWHM / FWTM Asymmetric  
Efficiency 94 %  
Peak intensity 0.5 cd/lm  
LEDs/each optic 1  
Light colour/type White  
Required components:

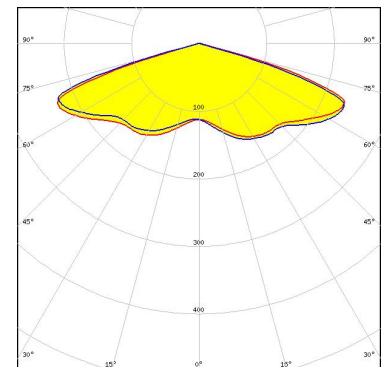

Light distribution files

### OPTICAL RESULTS (MEASURED):



LED LUXEON CoB 1211  
FWHM / FWTM Asymmetric  
Efficiency 93 %  
Peak intensity 0.4 cd/lm  
LEDs/each optic 1  
Light colour/type White  
Required components:  
Bender Wirth: 431 Typ L3

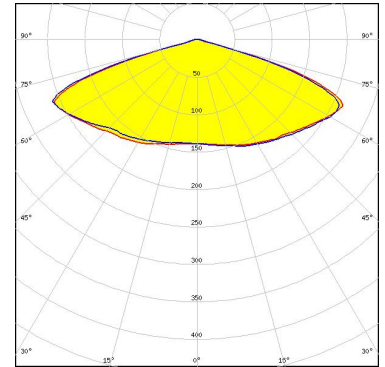

Light distribution files



LED LUXEON CoB 1321  
FWHM / FWTM Asymmetric  
Efficiency 93 %  
Peak intensity 0.3 cd/lm  
LEDs/each optic 1  
Light colour/type White  
Required components:

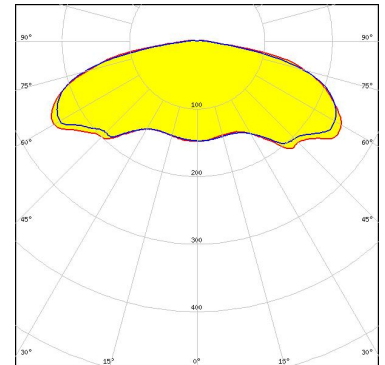

Light distribution files



LED LUXEON CoB 1825  
FWHM / FWTM Asymmetric  
Efficiency 93 %  
Peak intensity 0.3 cd/lm  
LEDs/each optic 1  
Light colour/type White  
Required components:

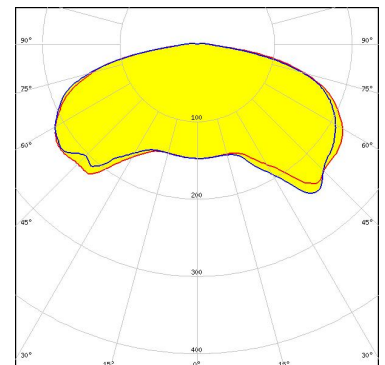

Light distribution files

### OPTICAL RESULTS (MEASURED):

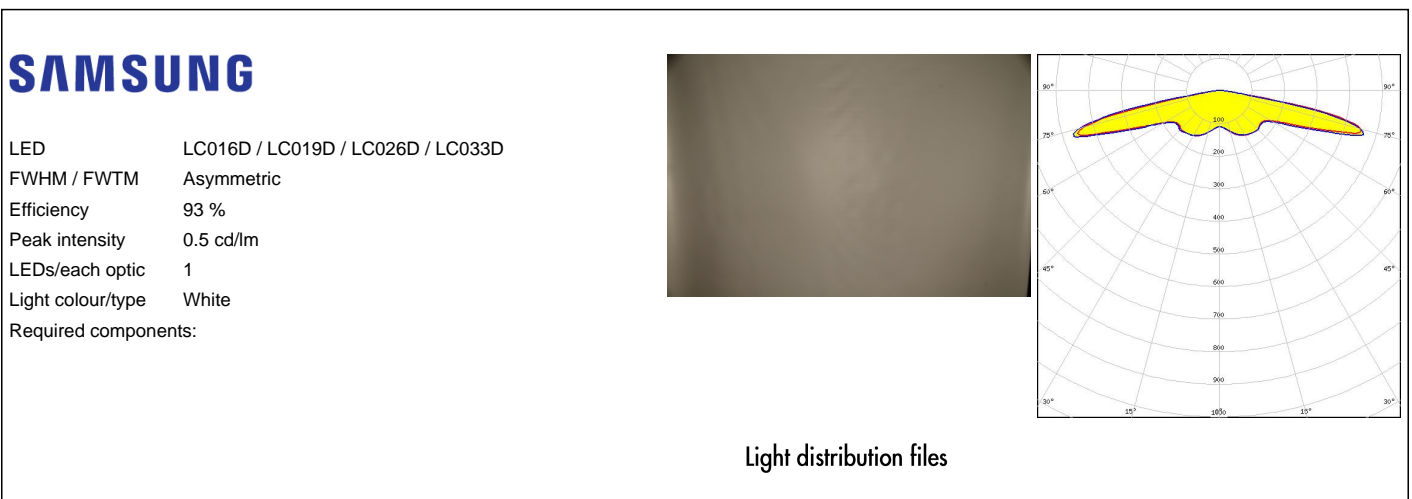
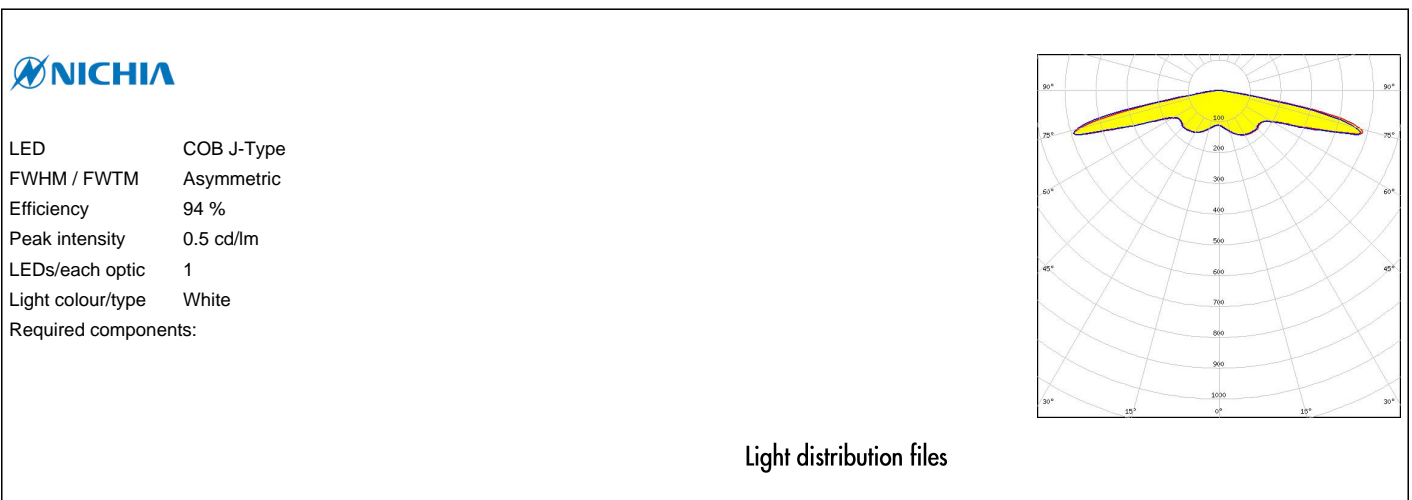
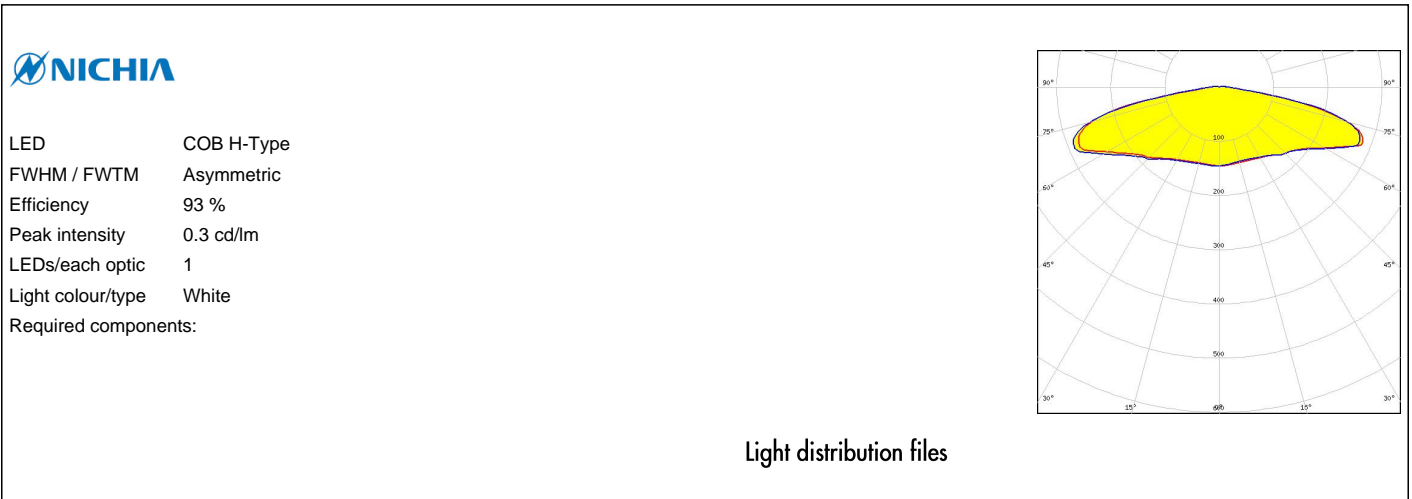

### OPTICAL RESULTS (MEASURED):

#### SAMSUNG

LED LC040D / LC060D / LC080D  
FWHM / FWTM Asymmetric  
Efficiency 93 %  
Peak intensity 0.3 cd/lm  
LEDs/each optic 1  
Light colour/type White  
Required components:

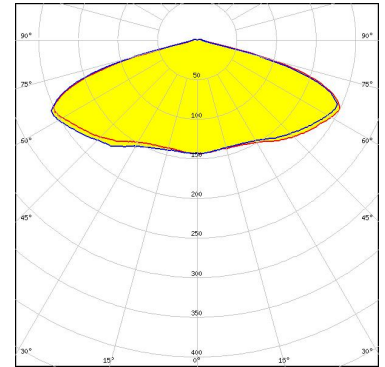

Light distribution files



LED MJT COB LES 14.5  
FWHM / FWTM Asymmetric  
Efficiency 94 %  
Peak intensity 0.5 cd/lm  
LEDs/each optic 1  
Light colour/type White  
Required components:  
Bender Wirth: 433 Typ Z1

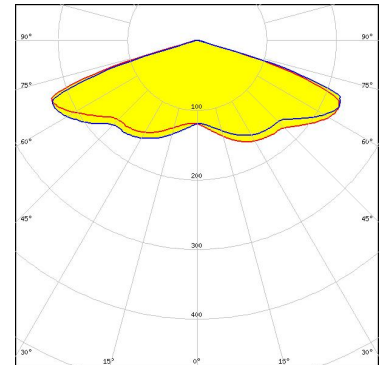

Light distribution files



LED MJT COB LES 22  
FWHM / FWTM Asymmetric  
Efficiency 94 %  
Peak intensity 0.3 cd/lm  
LEDs/each optic 1  
Light colour/type White  
Required components:  
Bender Wirth: 431 Typ Z1

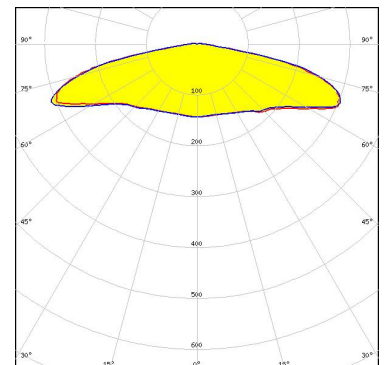

Light distribution files



### OPTICAL RESULTS (MEASURED):

 SEUL SEMICONDUCTOR	
LED	MJT COB LES 33
FWHM / FWTM	Asymmetric
Efficiency	94 %
Peak intensity	0.2 cd/lm
LEDs/each optic	1
Light colour/type	White
Required components:	

Light distribution files

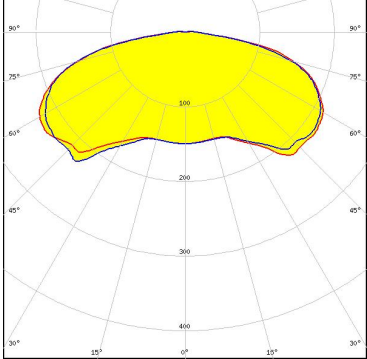

#### OPTICAL RESULTS (SIMULATED):

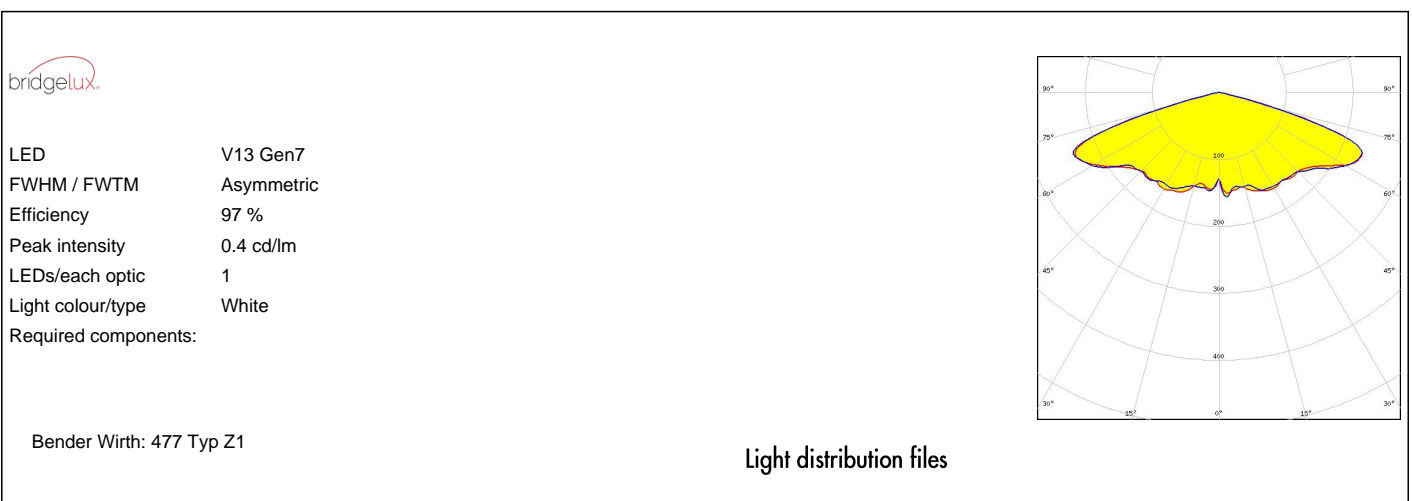
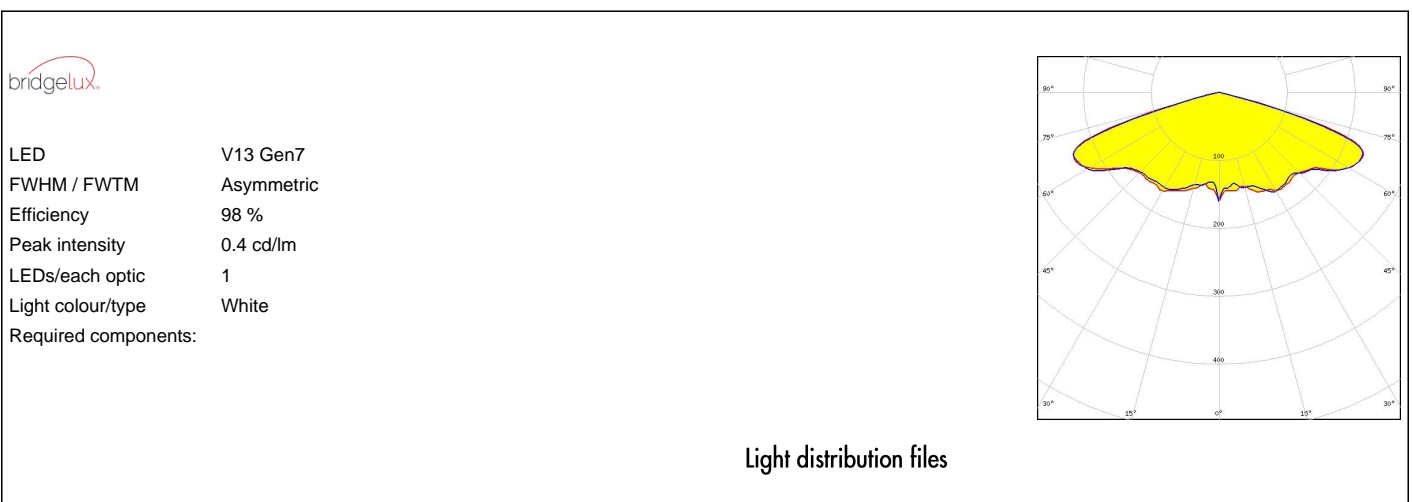
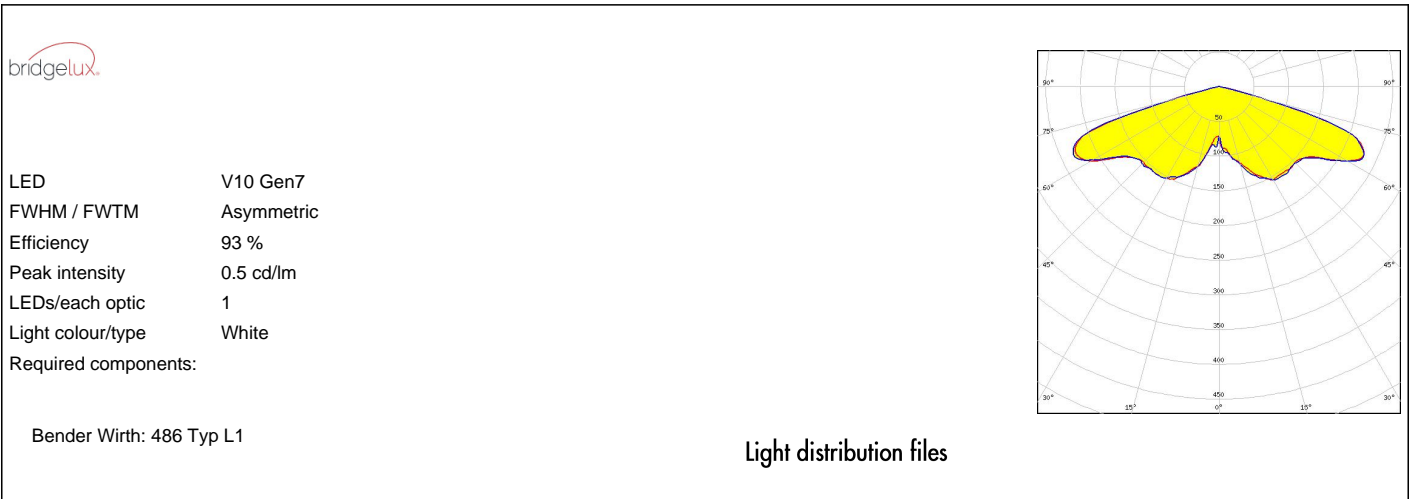

### OPTICAL RESULTS (SIMULATED):

#### CITIZEN

LED CLL04x/CLU04x  
 FWHM / FWTM Asymmetric  
 Efficiency 93 %  
 Peak intensity 0.3 cd/lm  
 LEDs/each optic 1  
 Light colour/type White  
 Required components:

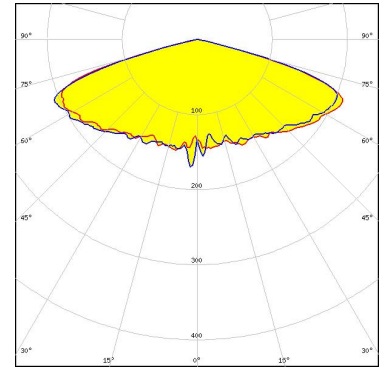

Light distribution files

#### CITIZEN

LED CLL04x/CLU04x  
 FWHM / FWTM Asymmetric  
 Efficiency 94 %  
 Peak intensity 0.3 cd/lm  
 LEDs/each optic 1  
 Light colour/type White  
 Required components:

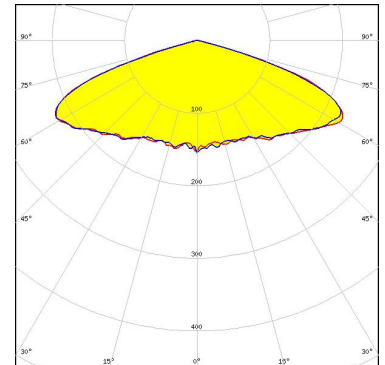

Bender Wirth: 431 Typ Z1

Light distribution files



LED CMU15xx  
 FWHM / FWTM Asymmetric  
 Efficiency 93 %  
 Peak intensity 0.4 cd/lm  
 LEDs/each optic 1  
 Light colour/type White  
 Required components:

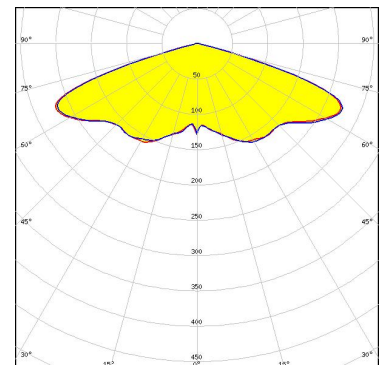

Light distribution files

### OPTICAL RESULTS (SIMULATED):



LED CXA/B 25xx  
 FWHM / FWTM Asymmetric  
 Efficiency 94 %  
 Peak intensity 0.4 cd/lm  
 LEDs/each optic 1  
 Light colour/type White  
 Required components:

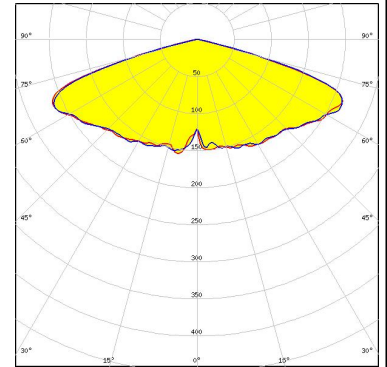

Light distribution files



LED CXA/B 30xx  
 FWHM / FWTM Asymmetric  
 Efficiency 94 %  
 Peak intensity 0.3 cd/lm  
 LEDs/each optic 1  
 Light colour/type White  
 Required components:

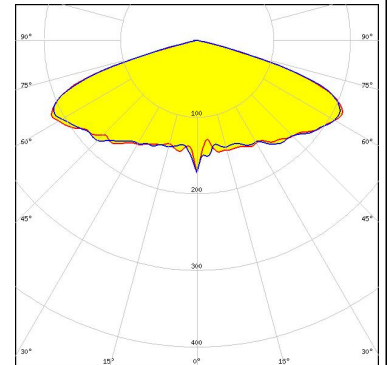

Bender Wirth: 447 Typ Z1

Light distribution files



LED LUXEON CoB 1213/1216/1812  
 FWHM / FWTM Asymmetric  
 Efficiency 92 %  
 Peak intensity 0.3 cd/lm  
 LEDs/each optic 1  
 Light colour/type White  
 Required components:

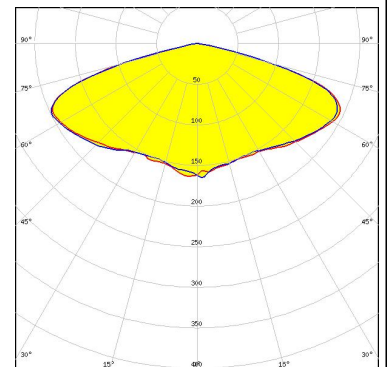

Light distribution files

### OPTICAL RESULTS (SIMULATED):

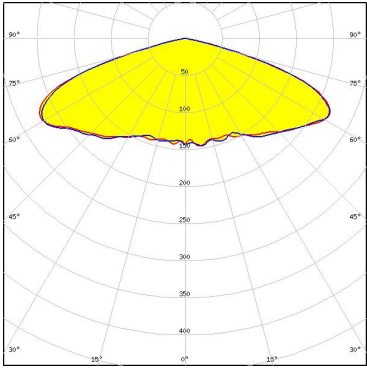
	
LED	CxM-22 (28x28)
FWHM / FWTM	Asymmetric
Efficiency	94 %
Peak intensity	0.3 cd/lm
LEDs/each optic	1
Light colour/type	White
Required components:	
Bender Wirth: 431 Typ Z1	
<a href="#">Light distribution files</a>	
	

### GENERAL INFORMATION:

NOTE: The typical beam angle will be changed by different color, chip size and chip position tolerance. The typical total beam angle is the full angle measured where the luminous intensity is half of the peak value.

Due to use of high power COB's with this product, special attention to proper thermal design is highly recommended. LEDiL has no liability for direct, indirect or consecutive damages arising from the LEDiL products being used outside of the recommended temperature range.

### MATERIALS:

As part of our continuous research and improvement processes, and to ensure the best possible quality and availability of our products, LEDiL reserves the right to change material grades without notice.

### PRODUCT DATA USER AGREEMENT AND DISCLAIMER:

The measured data in the provided downloadable LEDiL Product Datasheets and Mechanical 2D-Drawings is rounded and provided as reference for planning. LEDiL Oy's optical specifications have been verified by conducting performance testing of the products in accordance with the company's quality system. The reported data are averaged results of multiple measurements with typical variation. LEDiL Oy reserves the right to without prior notification make changes and improvements to its products.

LEDiL Oy assumes neither warranty, nor guarantee nor any other liability of any kind for the contents and correctness of the provided data. The provided data has been generated with highest diligence but the provided data may in reality not represent the complete possible variation range of all intrinsic parameters. Therefore, in certain cases a deviation from the provided data could occur.

LEDiL Oy reserves the right to undertake technical changes of its products without further notification which could lead to changes in the provided data. LEDiL Oy assumes no liability of any kind for the possible deviation from any provided data or any other damage resulting from the usage of the provided data.

The user agrees to this disclaimer and user agreement with the download or usage of the provided files.

#### LEDiL Oy

Joensuunkatu 13  
FI-24240 SALO  
Finland

#### LEDiL Inc.

228 West Page Street  
Suite D  
Sycamore IL 60178  
USA

#### Ledil Optics Technology (Shenzhen) Co., Ltd.

# 405 , Block B  
Casic Motor Building  
Shenzhen 518057  
P.R.CHINA

#### Local sales and technical support

[www.ledil.com/  
where\\_to\\_buy](http://www.ledil.com/where_to_buy)

#### Shipping locations

Poznan, Poland  
Hong Kong, China

#### Distribution Partners

[www.ledil.com/  
where\\_to\\_buy](http://www.ledil.com/where_to_buy)