

Peak Emission Wavelength: 560nm, 585nm, 635nm, 660nm

The MT101NP-XXX is a high reliability multi-chip emitter designed for applications requiring various wavelengths or more than one die in a single package. These devices can be custom sorted for specific power output.

FEATURES

- > High Luminance / High Reliability
- > Wide Radiation Pattern / White Ceramic Base
- > Low Power Consumption
- > Alternate Electrical Configurations

APPLICATIONS

- > Currency Validation
- > Medical / Biofluorescence
- > General Indication
- > Push Button Backlight

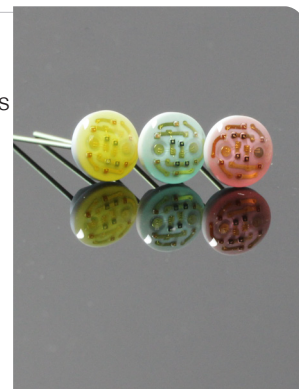

Absolute Maximum Ratings (Ta=25°C)



ITEMS	SYMBOL	RATINGS	UNIT
Forward Current	IF	15	mA
Power Dissipation	PD	240	mW
Operating Temperature Range	Topr	-20 ~ +60	°C
Storage Temperature Range	Tstg	-30 ~ +100	°C
Lead Soldering Temperature*1	Tls	260	°C

*1: Time 5 Sec max, Position: Up to 3mm from the body.

Electrical & Optical Characteristics (Ta = 25°C)

PART NO.	Material	IV(typ)	VF(typ)	VF(max)	λp(typ)	Δλ(typ)	Circuit
		@IF=10MA	@IF=10MA	@IF=10MA	@IF=10MA	@IF=10MA	
MT101NP-UG	GaP	50mcd	13.3V	16.4V	565nm	30nm	Bipolar
MT101NP-YL	GaAsP	20mcd	12.8V	15.8V	585nm	30nm	Bipolar
MT101NP-HR	GaAsP	25mcd	12.3V	15.2V	635nm	35nm	Bipolar
MT101NP-URD	GaAIAs	100mcd	11.8V	14.6V	660nm	20nm	Bipolar

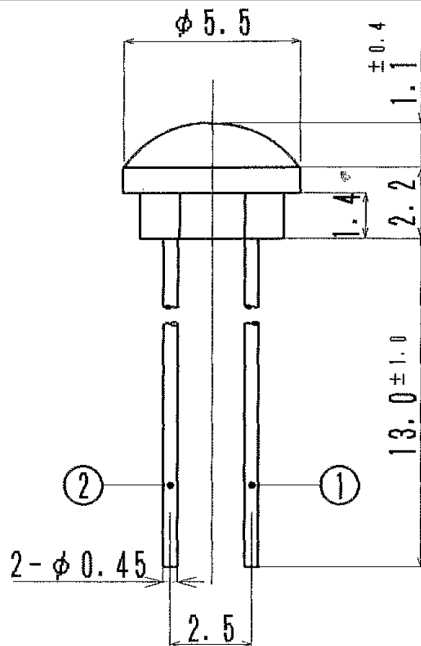
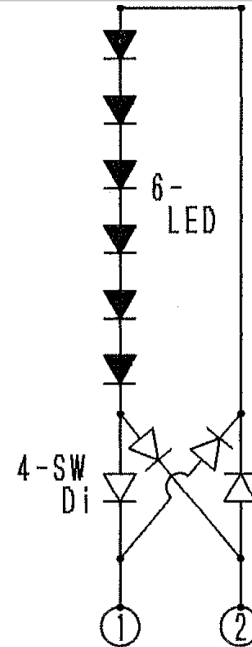
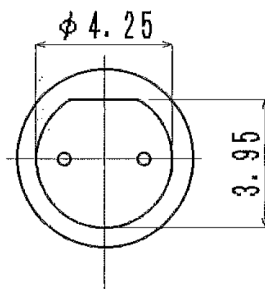

Unit: mm, Tolerance: ±0.2

The information contained herein is subject to change without notice.

2013-06-05