



## AA3528VRVCS/A

### 3.5 x 2.8 mm Surface Mount LED Lamp

#### DESCRIPTIONS

- The source color devices are made with InGaN Light Emitting Diode
- Electrostatic discharge and power surge could damage the LEDs
- It is recommended to use a wrist band or anti-electrostatic glove when handling the LEDs
- All devices, equipments and machineries must be electrically grounded

#### FEATURES

- Single color
- Suitable for all SMD assembly and solder process
- Available on tape and reel
- Ideal for backlighting
- Package: 2000 pcs / reel
- Moisture sensitivity level: 3
- Halogen-free
- RoHS compliant

#### APPLICATIONS

- Backlight
- Status indicator
- Home and smart appliances
- Wearable and portable devices
- Healthcare applications

#### ATTENTION

Observe precautions for handling electrostatic discharge sensitive devices



#### PACKAGE DIMENSIONS

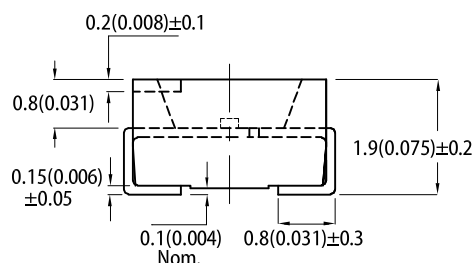
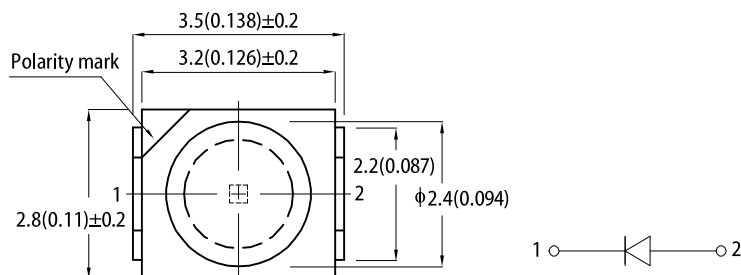

#### RECOMMENDED SOLDERING PATTERN

(units : mm; tolerance : ± 0.1)

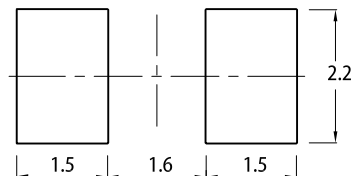

#### Notes:

1. All dimensions are in millimeters (inches).
2. Tolerance is ±0.25(0.01") unless otherwise noted.
3. The specifications, characteristics and technical data described in the datasheet are subject to change without prior notice.
4. The device has a single mounting surface. The device must be mounted according to the specifications.

#### SELECTION GUIDE

| Part Number   | Emitting Color (Material)                           | Iv (mcd) @ 20mA <sup>[2]</sup> |      | Viewing Angle <sup>[1]</sup> |
|---------------|---|--------------------------------|------|------------------------------|
|               |   | Min.                           | Typ. | 2θ1/2                        |
| AA3528VRVCS/A | <span style="color: magenta;">■</span> Pink (InGaN) | 200                            | 300  | 120°                         |

Notes:  
 1. θ1/2 is the angle from optical centerline where the luminous intensity is 1/2 of the optical peak value.  
 2. Luminous intensity / luminous flux: +/-15%.  
 3. Luminous intensity value is traceable to CIE127-2007 standards.

ELECTRICAL / OPTICAL CHARACTERISTICS at  $T_A=25^{\circ}\text{C}$ 

| Parameter  | Symbol        | Emitting Color | Value |      | Unit                         |
|--|---------------|----------------|-------|------|------------------------------|
|  |               |                | Typ.  | Max. |                              |
| Chromaticity Coordinates x<br>$I_F = 20\text{mA}$  | $x^{[1]}$     | Pink           | 0.35  | -    | -                            |
| Chromaticity Coordinates y<br>$I_F = 20\text{mA}$  | $y^{[1]}$     | Pink           | 0.15  | -    | -                            |
| Capacitance  | C             | Pink           | 100   | -    | pF                           |
| Forward Voltage $I_F = 20\text{mA}$  | $V_F^{[2]}$   | Pink           | 3.3   | 4.0  | V                            |
| Reverse Current ( $V_R = 5\text{V}$ )  | $I_R$         | Pink           | -     | 50   | $\mu\text{A}$                |
| Temperature Coefficient of x<br>$I_F = 20\text{mA}$ , $-10^{\circ}\text{C} \leq T \leq 85^{\circ}\text{C}$     | $\text{TC}_x$ | Pink           | -0.15 | -    | $10^{-3}/^{\circ}\text{C}$   |
| Temperature Coefficient of y<br>$I_F = 20\text{mA}$ , $-10^{\circ}\text{C} \leq T \leq 85^{\circ}\text{C}$     | $\text{TC}_y$ | Pink           | -0.18 | -    | $10^{-3}/^{\circ}\text{C}$   |
| Temperature Coefficient of $V_F$<br>$I_F = 20\text{mA}$ , $-10^{\circ}\text{C} \leq T \leq 85^{\circ}\text{C}$ | $\text{TC}_V$ | Pink           | -3.0  | -    | $\text{mV}/^{\circ}\text{C}$ |

## Notes:

1. Measurement tolerance of the chromaticity coordinates is  $\pm 0.01$ .
2. Forward voltage:  $\pm 0.1\text{V}$ .
3. Excess driving current and / or operating temperature higher than recommended conditions may result in severe light degradation or premature failure.

ABSOLUTE MAXIMUM RATINGS at  $T_A=25^{\circ}\text{C}$ 

| Parameter                                    | Symbol             | Value      | Unit                        |
|--|--------------------|------------|-----------------------------|
| Power Dissipation                            | $P_D$              | 120        | mW                          |
| Reverse Voltage                              | $V_R$              | 5          | V                           |
| Junction Temperature                         | $T_j$              | 100        | $^{\circ}\text{C}$          |
| Operating Temperature                        | $T_{op}$           | -40 to +85 | $^{\circ}\text{C}$          |
| Storage Temperature                          | $T_{stg}$          | -40 to +85 | $^{\circ}\text{C}$          |
| DC Forward Current                           | $I_F$              | 30         | mA                          |
| Peak Forward Current                         | $I_{FP}^{[1]}$     | 100        | mA                          |
| Electrostatic Discharge Threshold (HBM)      | -                  | 250        | V                           |
| Thermal Resistance (Junction / Ambient)      | $R_{th\ JA}^{[2]}$ | 250        | $^{\circ}\text{C}/\text{W}$ |
| Thermal Resistance (Junction / Solder point) | $R_{th\ JS}^{[2]}$ | 140        | $^{\circ}\text{C}/\text{W}$ |

## Notes:

1. 1/10 Duty Cycle, 0.1ms Pulse Width.
2.  $R_{th\ JA}$ ,  $R_{th\ JS}$  Results from mounting on PC board FR4 (pad size  $\geq 16\text{mm}^2$  per pad).
3. Relative humidity levels maintained between 40% and 60% in production area are recommended to avoid the build-up of static electricity – Ref JEDEC/JESD625-A and JEDEC/J-STD-033.

### TECHNICAL DATA

#### SPATIAL DISTRIBUTION

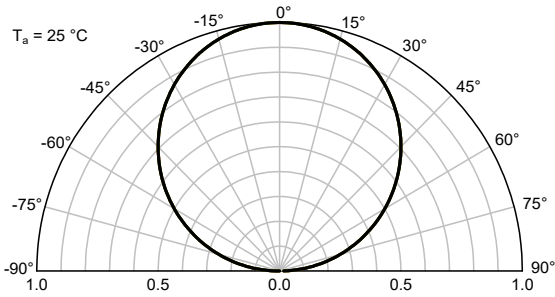

### PINK

Forward Current vs. Forward Voltage

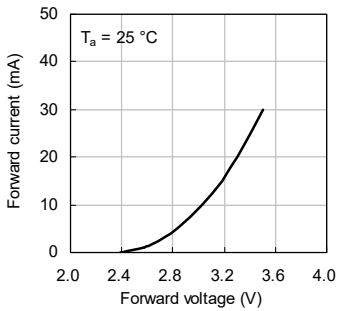

Luminous Intensity vs. Forward Current

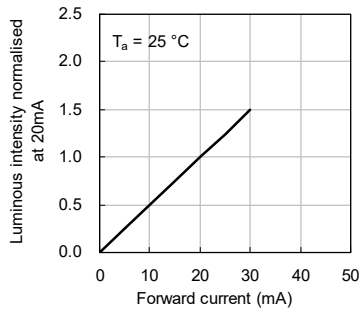

Forward Current Derating Curve

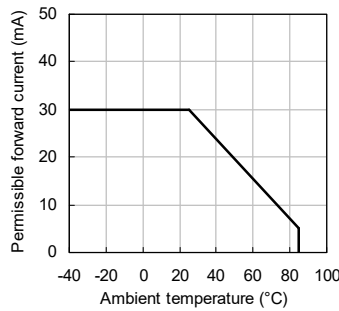

Luminous Intensity vs. Ambient Temperature

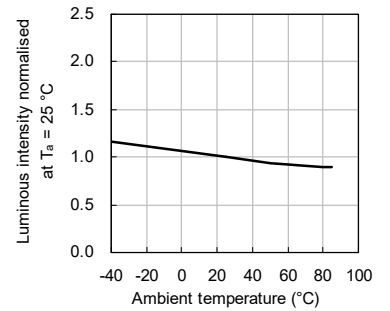

#### REFLOW SOLDERING PROFILE for LEAD-FREE SMD PROCESS

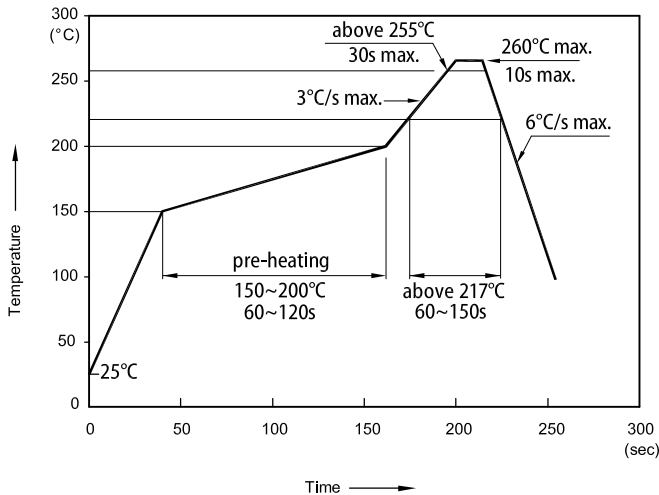

- Notes:
1. Don't cause stress to the LEDs while it is exposed to high temperature.
  2. The maximum number of reflow soldering passes is 2 times.
  3. Reflow soldering is recommended. Other soldering methods are not recommended as they might cause damage to the product.

#### TAPE SPECIFICATIONS (units : mm)

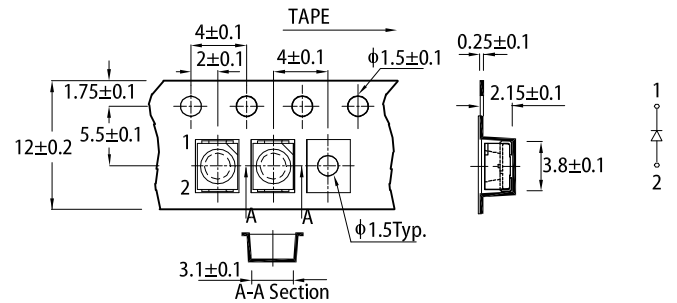

#### REEL DIMENSION (units : mm)

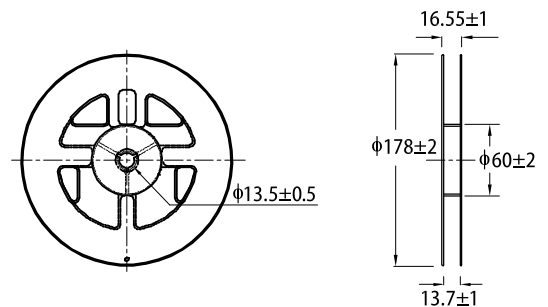

### CIE CHROMATICITY DIAGRAM

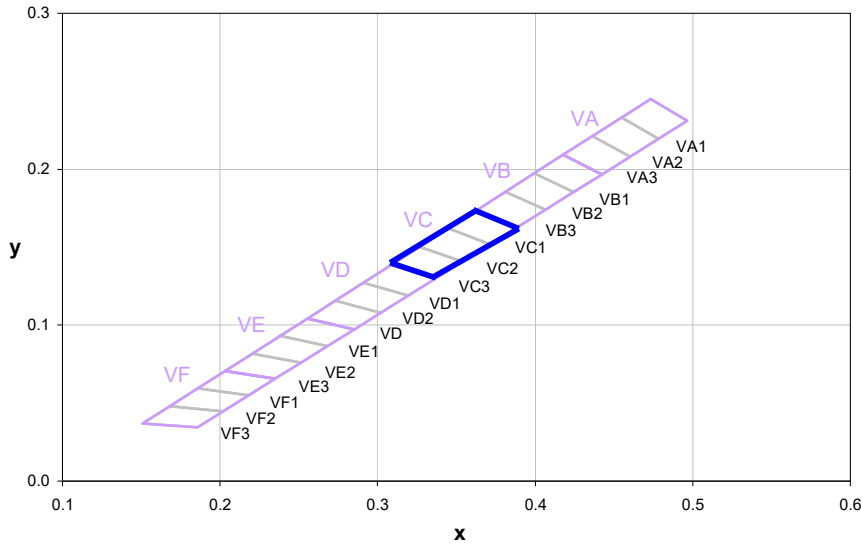

Notes:  
 1. Shipment may contain more than one chromaticity regions.  
 2. Orders for single chromaticity region are generally not accepted.  
 3. Measurement tolerance of the chromaticity coordinates is  $\pm 0.01$ .  
 4. This device utilizes S/CASN phosphor technology licensed by NIMS. For more information please refer to <https://www.kingbright.com/content/detail/news/30/12>

|     | x      | y      |     | x      | y      |     | x      | y      |
|-----|--------|--------|-----|--------|--------|-----|--------|--------|
| VA1 | 0.4735 | 0.2451 | VC1 | 0.3629 | 0.1737 | VE1 | 0.2556 | 0.1044 |
|     | 0.4548 | 0.2330 |     | 0.3448 | 0.1620 |     | 0.2380 | 0.0931 |
|     | 0.4783 | 0.2194 |     | 0.3713 | 0.1518 |     | 0.2682 | 0.0867 |
|     | 0.4964 | 0.2309 |     | 0.3888 | 0.1629 |     | 0.2850 | 0.0973 |
| VA2 | 0.4548 | 0.2330 | VC2 | 0.3448 | 0.1620 | VE2 | 0.2380 | 0.0931 |
|     | 0.4363 | 0.2211 |     | 0.3267 | 0.1504 |     | 0.2205 | 0.0818 |
|     | 0.4602 | 0.2080 |     | 0.3538 | 0.1408 |     | 0.2514 | 0.0761 |
|     | 0.4783 | 0.2194 |     | 0.3713 | 0.1518 |     | 0.2682 | 0.0867 |
| VA3 | 0.4363 | 0.2211 | VC3 | 0.3267 | 0.1504 | VE3 | 0.2205 | 0.0818 |
|     | 0.4178 | 0.2091 |     | 0.3088 | 0.1388 |     | 0.2030 | 0.0705 |
|     | 0.4422 | 0.1966 |     | 0.3364 | 0.1298 |     | 0.2347 | 0.0656 |
|     | 0.4602 | 0.2080 |     | 0.3538 | 0.1408 |     | 0.2514 | 0.0761 |
| VB1 | 0.4178 | 0.2091 | VD1 | 0.3088 | 0.1388 | VF1 | 0.2030 | 0.0705 |
|     | 0.3994 | 0.1973 |     | 0.2910 | 0.1273 |     | 0.1857 | 0.0593 |
|     | 0.4243 | 0.1853 |     | 0.3192 | 0.1189 |     | 0.2182 | 0.0551 |
|     | 0.4422 | 0.1966 |     | 0.3364 | 0.1298 |     | 0.2347 | 0.0656 |
| VB2 | 0.3994 | 0.1973 | VD2 | 0.2910 | 0.1273 | VF2 | 0.1857 | 0.0593 |
|     | 0.3811 | 0.1855 |     | 0.2732 | 0.1158 |     | 0.1683 | 0.0481 |
|     | 0.4065 | 0.1741 |     | 0.3021 | 0.1081 |     | 0.2018 | 0.0448 |
|     | 0.4243 | 0.1853 |     | 0.3192 | 0.1189 |     | 0.2182 | 0.0551 |
| VB3 | 0.3811 | 0.1855 | VD3 | 0.2732 | 0.1158 | VF3 | 0.1683 | 0.0481 |
|     | 0.3629 | 0.1737 |     | 0.2556 | 0.1044 |     | 0.1510 | 0.0369 |
|     | 0.3888 | 0.1629 |     | 0.2850 | 0.0973 |     | 0.1856 | 0.0345 |
|     | 0.4065 | 0.1741 |     | 0.3021 | 0.1081 |     | 0.2018 | 0.0448 |

### PACKING & LABEL SPECIFICATIONS

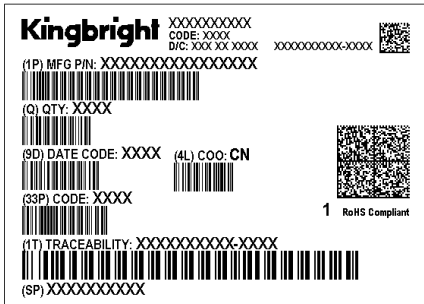
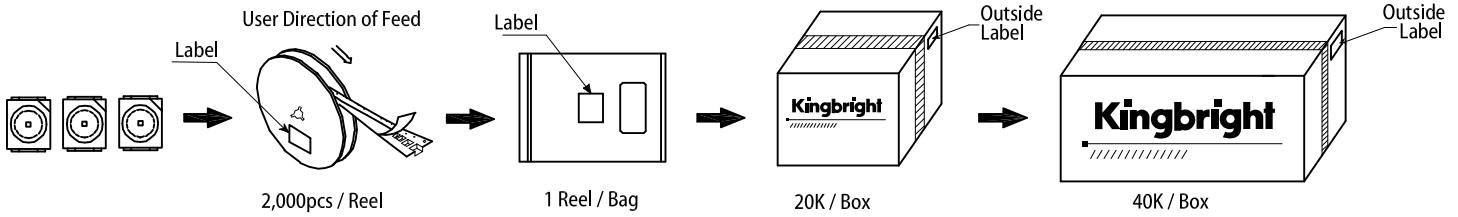

### HANDLING PRECAUTIONS

Compare to epoxy encapsulant that is hard and brittle, silicone is softer and flexible. Although its characteristic significantly reduces thermal stress, it is more susceptible to damage by external mechanical force. As a result, special handling precautions need to be observed during assembly using silicone encapsulated LED products. Failure to comply might lead to damage and premature failure of the LED.

1. Handle the component along the side surfaces by using forceps or appropriate tools.
2. Do not directly touch or handle the silicone lens surface. It may damage the internal circuitry.
3. Do not stack together assembled PCBs containing exposed LEDs. Impact may scratch the silicone lens or damage the internal circuitry.

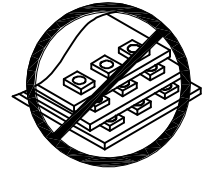
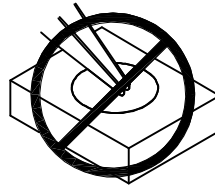
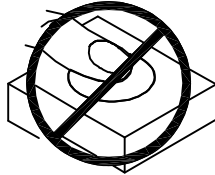
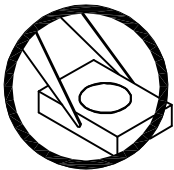

- 4-1. The inner diameter of the SMD pickup nozzle should not exceed the size of the LED to prevent air leaks.
- 4-2. A pliable material is suggested for the nozzle tip to avoid scratching or damaging the LED surface during pickup.
- 4-3. The dimensions of the component must be accurately programmed in the pick-and-place machine to insure precise pickup and avoid damage during production.
5. As silicone encapsulation is permeable to gases, some corrosive substances such as H<sub>2</sub>S might corrode silver plating of lead frame. Special care should be taken if an LED with silicone encapsulation is to be used near such substances.

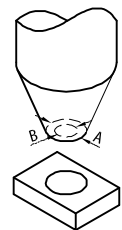

### PRECAUTIONARY NOTES

1. The information included in this document reflects representative usage scenarios and is intended for technical reference only.
2. The part number, type, and specifications mentioned in this document are subject to future change and improvement without notice. Before production usage customer should refer to the latest datasheet for the updated specifications.
3. When using the products referenced in this document, please make sure the product is being operated within the environmental and electrical limits specified in the datasheet. If customer usage exceeds the specified limits, Kingbright will not be responsible for any subsequent issues.
4. The information in this document applies to typical usage in consumer electronics applications. If customer's application has special reliability requirements or have life-threatening liabilities, such as automotive or medical usage, please consult with Kingbright representative for further assistance.
5. The contents and information of this document may not be reproduced or re-transmitted without permission by Kingbright.
6. All design applications should refer to Kingbright application notes available at <https://www.KingbrightUSA.com/ApplicationNotes>