



Multi SMD LED RGB



DESCRIPTION

The VLMRGB6112.. is a high brightness tricolor LED designed primarily for interior automotive lighting, RGB displays and backlights. It is using the popular 3528 SMD package with white reflector and lambertian emission characteristic. The PLCC-6 package allows independent individual driving of each chip also in serial circuits and thus a gapless coverage of a wide color space by additive color mixing. It provides high reliability in a large temperature range from -40 °C to +110°C, using highly suitable UV stable package materials and corrosion resistant metal surfaces.

PRODUCT GROUP AND PACKAGE DATA

- Product group: LED
- Package: SMD PLCC-6
- Product series: RGB
- Angle of half intensity: $\pm 60^\circ$

FEATURES

- Utilizing high brightness AlInGaP and InGaN chip technologies
- 6 pin RGB SMD LED package allows independent control of each chip
- Compact package outline dimensions (L x W x H in mm): 3.5 x 2.8 x 1.45
- AEC-Q101 qualified, according to version D
- Qualified according to JEDEC® moisture sensitivity level 2
- Compatible to IR reflow soldering
- Operation temperature range: -40 °C to 110 °C
- Excellent corrosion robustness (H₂S)
- ESD-withstand voltage: up to 2 kV according to JESD22-A114-B
- Luminous intensities and colors categorized per reel
- Material categorization: for definitions of compliance please see www.vishay.com/doc?99912



APPLICATIONS

- Automotive, interior lighting
- Wide range of accent and decorative lighting
- Displays: full color message and displays video boards
- Consumer appliances: backlight LCDs, PDAs, TVs
- Industry: white goods such as ovens, microwaves, etc.

PARTS TABLE														
PART	COLOR	LUMINOUS INTENSITY (mcd)			at I _F (mA)	WAVELENGTH (nm)			at I _F (mA)	FORWARD VOLTAGE (V)			at I _F (mA)	TECHNOLOGY
		MIN.	TYP.	MAX.		MIN.	TYP.	MAX.		MIN.	TYP.	MAX.		
VLMRGB6112-00-GS08	Red	560	730	920	20	618	624	629	20	1.8	2.0	2.4	20	AlInGaP
	True green	900	1030	1800	20	519	526	534	20	2.7	3.1	3.6	20	InGaN
	Blue	180	230	450	20	463	469	476	20	2.7	3.0	3.6	20	InGaN

Note

- Measurement accuracy: $\pm 11\%$ for luminous intensity, ± 1 nm for dominant wavelength, ± 0.1 V for forward voltage



ABSOLUTE MAXIMUM RATINGS ($T_{amb} = 25\text{ }^{\circ}\text{C}$, unless otherwise specified)				
VLMRGB6112.., RED				
PARAMETER	TEST CONDITION	SYMBOL	VALUE	UNIT
Forward current		I_F	30	mA
Power dissipation		P_{tot}	72	mW
Junction temperature		T_j	115	$^{\circ}\text{C}$
Peak forward current	$t_p < 100\text{ }\mu\text{s}$, duty cycle = 0.1	I_{FM}	100	mA
Thermal resistance junction-to-solder point, 1 chip		R_{thJP}	170	K/W
Thermal resistance junction-to-ambient, 1 chip	Mounted on FR4 PC board ($t = 1.6\text{ mm}$) with Cu pad size $> 16\text{ mm}^2$	R_{thJA}	210	K/W
Operating temperature		T_{amb}	-40 to +110	$^{\circ}\text{C}$
Storage temperature		T_{stg}	-40 to +110	$^{\circ}\text{C}$
ESD voltage	HBM	V_{ESD}	2000	V

ABSOLUTE MAXIMUM RATINGS ($T_{amb} = 25\text{ }^{\circ}\text{C}$, unless otherwise specified)				
VLMRGB6112.., TRUE GREEN, BLUE				
PARAMETER	TEST CONDITION	SYMBOL	VALUE	UNIT
Forward current		I_F	30	mA
Power dissipation		P_{tot}	114	mW
Junction temperature		T_j	125	$^{\circ}\text{C}$
Peak forward current	$t_p < 100\text{ }\mu\text{s}$, duty cycle = 0.1	I_{FM}	100	mA
Thermal resistance junction-to-solder point, 1 chip		R_{thJP}	170	K/W
Thermal resistance junction-to-ambient, 1 chip	Mounted on FR4 PC board ($t = 1.6\text{ mm}$) with Cu pad size $> 16\text{ mm}^2$	R_{thJA}	210	K/W
Operating temperature		T_{amb}	-40 to +110	$^{\circ}\text{C}$
Storage temperature		T_{stg}	-40 to +110	$^{\circ}\text{C}$
ESD voltage	HBM	V_{ESD}	2000	V

OPTICAL AND ELECTRICAL CHARACTERISTICS ($T_{amb} = 25\text{ }^{\circ}\text{C}$, unless otherwise specified)											
VLMRGB6112.., RED, TRUE GREEN, BLUE											
PARAMETER	TEST CONDITION	PART	COLOR	SYMBOL	MIN.	TYP.	MAX.	UNIT			
Luminous intensity	$I_F = 20\text{ mA}$	VLMRGB6112-00	red	I_V	560	730	920	mcd			
			true green		900	1030	1800				
			blue		180	230	450				
Dominant wavelength		$I_F = 20\text{ mA}$	VLMRGB6112-00	red	λ_d	618	624	629	nm		
				true green		519	526	534			
				blue		463	469	476			
Peak wavelength			$I_F = 20\text{ mA}$	VLMRGB6112-00	red	λ_p	-	630	-	nm	
					true green		-	518	-		
					blue		-	468	-		
Spectral half width at 50 % I_{rel} max.				$I_F = 20\text{ mA}$	VLMRGB6112-00	red	$\Delta\lambda_{0.5}$	-	20	-	nm
						true green		-	35	-	
						blue		-	25	-	
Angle of half intensity	$I_F = 20\text{ mA}$				VLMRGB6112-00	red	φ	-	± 60	-	$^{\circ}$
						true green		-	± 60	-	
						blue		-	± 60	-	
Forward voltage		$I_F = 20\text{ mA}$			VLMRGB6112-00	red	V_F	1.8	2.0	2.4	V
						true green		2.7	3.1	3.6	
						blue		2.7	3.0	3.6	
Reverse current ⁽¹⁾			$V_R = 12\text{ V}$		VLMRGB6112-00	red	I_R	-	-	10	μA
Reverse voltage ⁽¹⁾			$I_{FZ} = 20\text{ mA}$		VLMRGB6112-00	true green	V_R	-	-	1.2	V
						blue		-	-	1.2	

Notes

- Not designed for operating in reverse direction.
Measurement accuracy: $\pm 11\%$ for luminous intensity, $\pm 1\text{ nm}$ for dominant wavelength, $\pm 0.1\text{ V}$ for forward voltage
- (1) Only applied for testing purpose



LUMINOUS INTENSITY CLASSIFICATION			
COLOR	GROUP	LUMINOUS INTENSITY I_V (mcd)	
		MIN.	MAX.
Blue	S1	180	224
	S2	224	280
	T1	280	355
	T2	355	450
Red	U2	560	710
	V1	710	920
True green	V2	900	1120
	AA	1120	1400
	AB	1400	1800

Note

- Luminous intensity is tested at a current pulse duration of 25 ms and an accuracy of $\pm 11\%$. The above classification represents the brightness range which includes only a few brightness groups. Only one group per color will be shipped on each reel (there will be no mixing of two groups on each reel). In order to ensure availability, single brightness groups will not be orderable. In a similar manner for colors where wavelength groups are measured and binned, single wavelength groups will be shipped on any one reel. In order to ensure availability, single wavelength groups will not be orderable

COLOR CLASSIFICATION						
GROUP	DOM. WAVELENGTH (nm)					
	BLUE		RED		TRUE GREEN	
	MIN.	MAX.	MIN.	MAX.	MIN.	MAX.
1	463	467	-	-	-	-
2	467	471	-	-	-	-
3	471	476	-	-	-	-
4	-	-	618	629	-	-
5	-	-	-	-	519	524
6	-	-	-	-	524	529
7	-	-	-	-	529	534

Note

- Wavelengths are tested at a current pulse duration of 25 ms and an accuracy of ± 1 nm. Only one wavelength group is allowed for each chip within one reel

MARKING EXAMPLE FOR SELECTION CODE ON LABEL

Selection code: V1V2S2-462 (sequence: RGB for both, I_V and color groups)

- V1V2S2:
 - I_V group red: V1 (710 mcd to 920 mcd)
 - I_V group green: V2 (900 mcd to 1120 mcd)
 - I_V group blue: S2 (224 mcd to 280 mcd)
- 462:
 - color group red: 4 (618 nm to 629 nm)
 - color group green: 6 (524 nm to 529 nm)
 - color group blue: 2 (467 nm to 471 nm)



TYPICAL CHARACTERISTICS ($T_{amb} = 25\text{ }^{\circ}\text{C}$, unless otherwise specified)

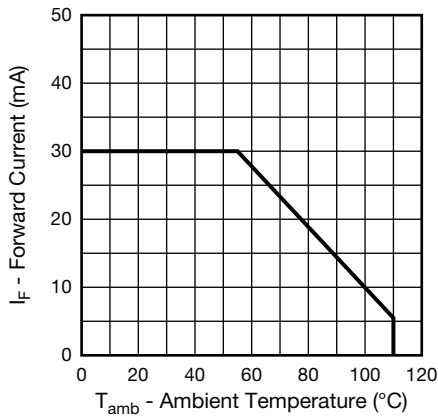

Fig. 1 - Forward Current vs. Ambient Temperature

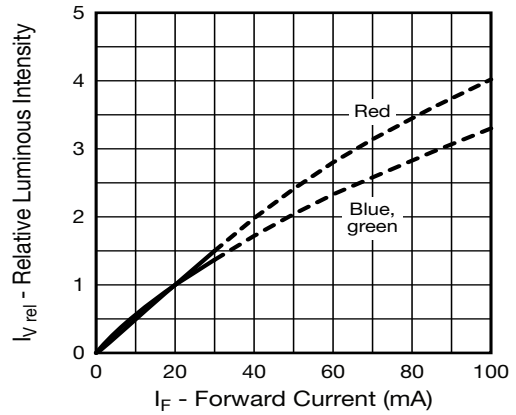

Fig. 4 - Relative Luminous Intensity vs. Forward Current

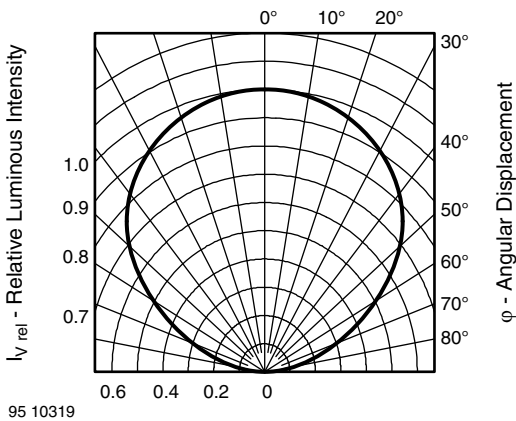

Fig. 2 - Relative Luminous Intensity vs. Angular Displacement

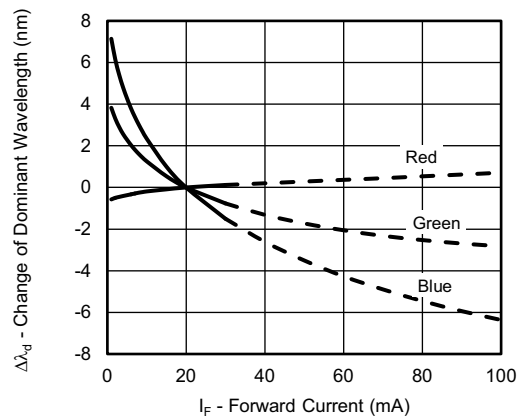

Fig. 5 - Change of Dominant Wavelength vs. Forward Current

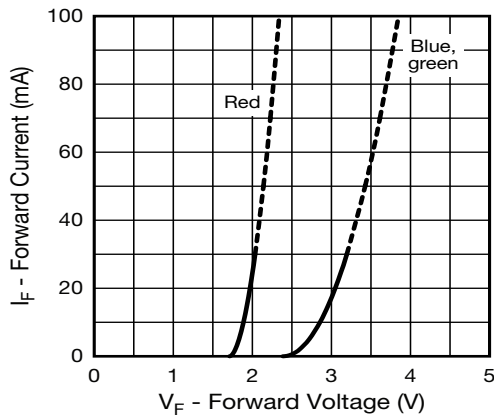

Fig. 3 - Forward Current vs. Forward Voltage

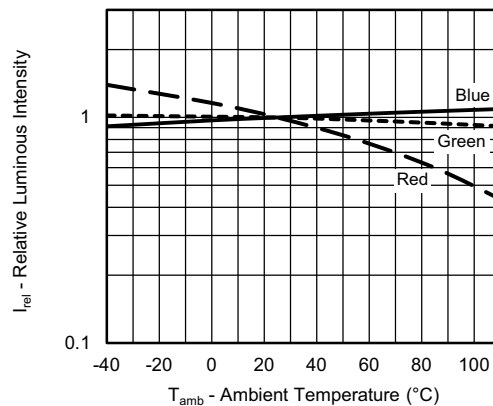

Fig. 6 - Relative Luminous Intensity vs. Ambient Temperature

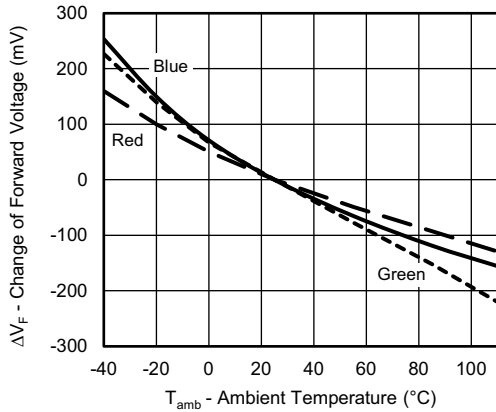

Fig. 7 - Change of Forward Voltage vs. Ambient Temperature

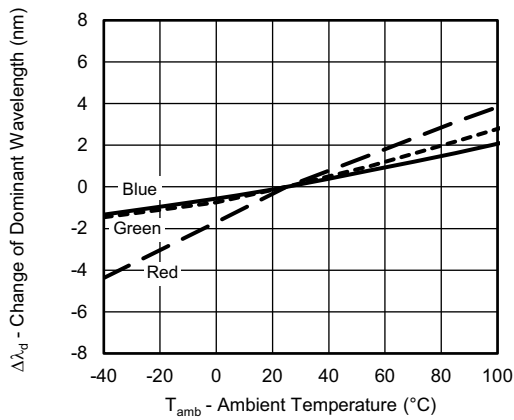

Fig. 8 - Change of Dominant Wavelength vs. Ambient Temperature

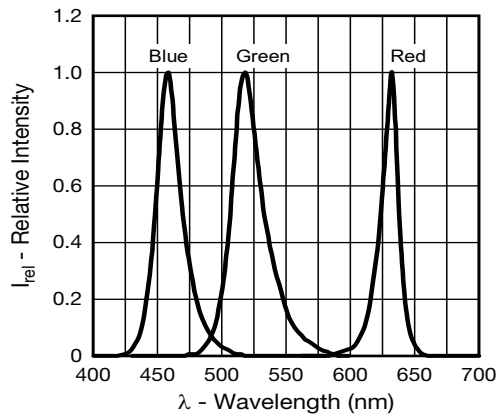
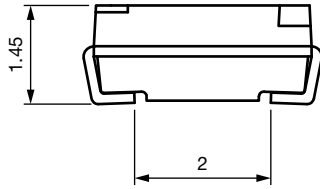

Fig. 9 - Relative Intensity vs. Wavelength



PACKAGE DIMENSIONS / SOLDERING PADS DIMENSIONS in millimeters



Source Color	Pin Assignment
InGaN Green	1, 6
AllnGaP Red	2, 5
InGaN Blue	3, 4

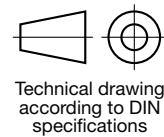
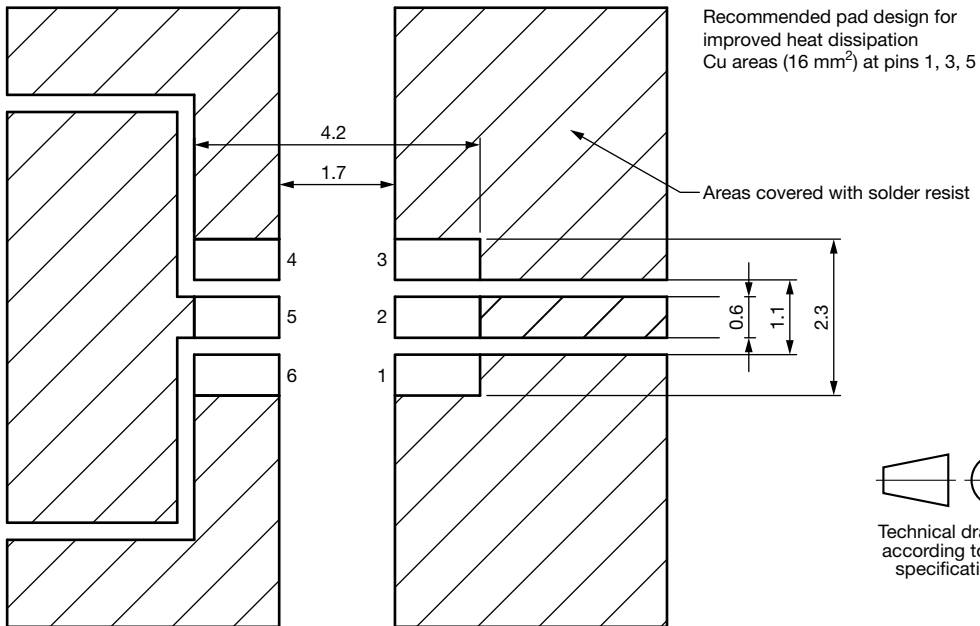
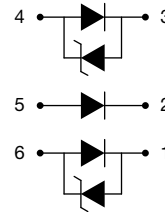
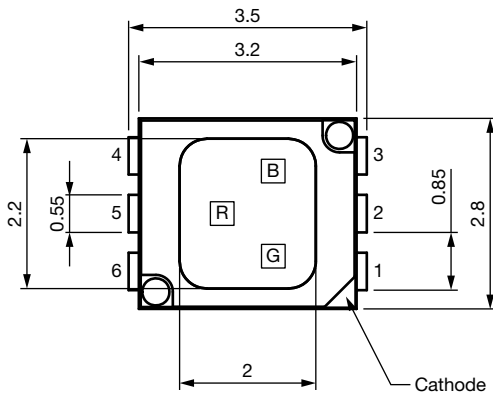

Drawing-No.: 6.541-5111.01-4
Issue: 2; 11.04.17

Not indicated tolerances ± 0.1



TAPING DIMENSIONS in millimeters

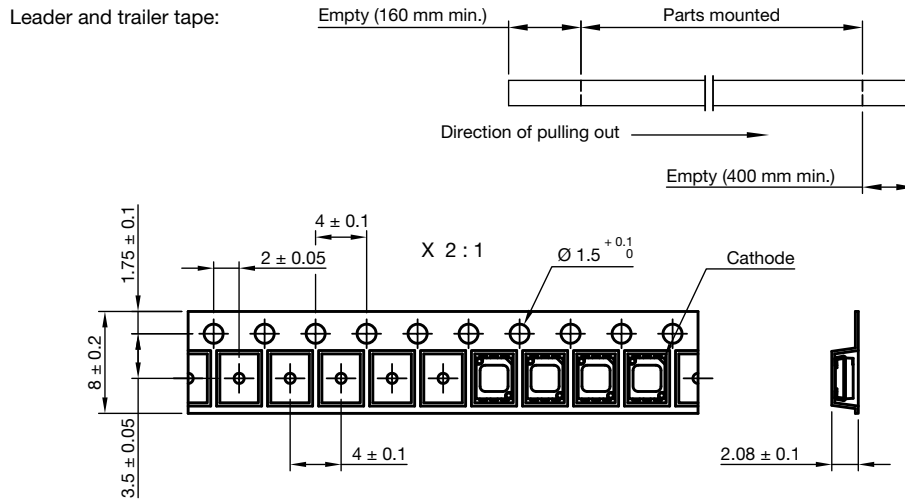
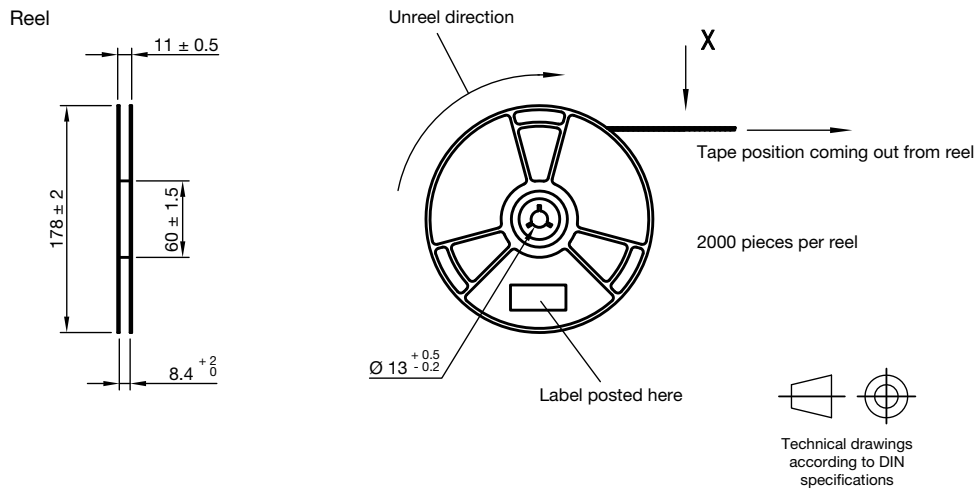

Drawing-No.: 9.800-5136.01-4
Issue: 1; 16.09.15

SOLDERING PROFILE

Fig. 10 - Vishay Lead (Pb)-free Reflow Soldering Profile According to J-STD-020

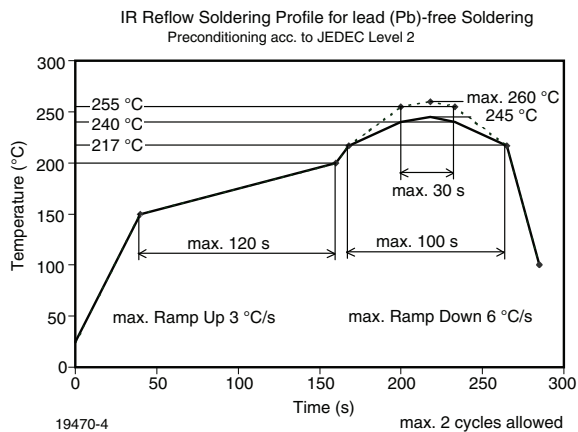



BAR CODE PRODUCT LABEL (example)

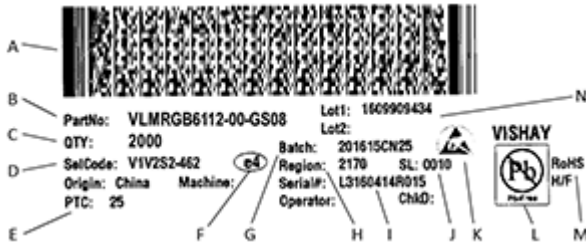

- A. 2D bar code
- B. Vishay part number
- C. Quantity
- D. Selection code (bin): brightness and color groups
- E. Code of manufacturing plant
- F. Termination plating finish
- G. Batch = date code: year / week / plant code
- H. Region code
- I. Internal serial number
- J. Sales location
- K. ESD symbol
- L. Lead (Pb)-free symbol
- M. RoHS symbol, halogen-free symbol
- N. Internal lot numbers

DRY PACKING

The reel is packed in an anti-humidity bag to protect the devices from absorbing moisture during transportation and storage.

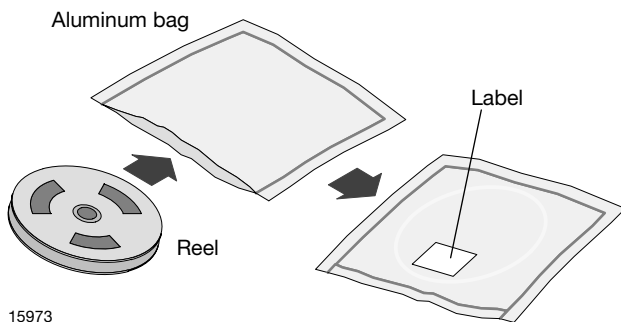

FINAL PACKING

The sealed reel is packed into a cardboard box. A secondary cardboard box is used for shipping purposes.

RECOMMENDED METHOD OF STORAGE

Dry box storage is recommended as soon as the aluminum bag has been opened to prevent moisture absorption. The following conditions should be observed, if dry boxes are not available:

- Storage temperature 10 °C to 30 °C
- Storage humidity ≤ 60 % RH max.

After more than 1 year under these conditions moisture content will be too high for reflow soldering.

In case of moisture absorption, the devices will recover to the former condition by drying under the following condition:
 192 h at 40 °C + 5 °C / - 0 °C and < 5 % RH (dry air / nitrogen) or
 96 h at 60 °C + 5 °C and < 5 % RH for all device containers or
 24 h at 100 °C + 5 °C not suitable for reel or tubes.

An EIA JEDEC standard JESD22-A112 level 2 label is included on all aluminum dry bags.

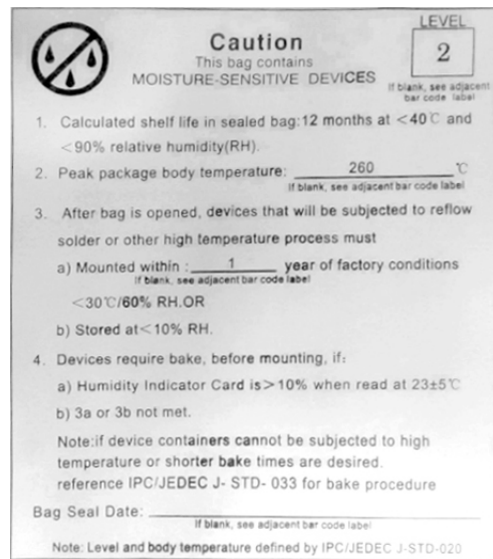

Example of JESD22-A112 level 2 label

ESD PRECAUTION

Proper storage and handling procedures should be followed to prevent ESD damage to the devices especially when they are removed from the antistatic shielding bag. Electrostatic sensitive devices warning labels are on the packaging.

VISHAY SEMICONDUCTORS STANDARD BAR CODE LABELS

The Vishay Semiconductors standard bar code labels are printed at final packing areas. The labels are on each packing unit and contain Vishay Semiconductors specific data.



Disclaimer

ALL PRODUCT, PRODUCT SPECIFICATIONS AND DATA ARE SUBJECT TO CHANGE WITHOUT NOTICE TO IMPROVE RELIABILITY, FUNCTION OR DESIGN OR OTHERWISE.

Vishay Intertechnology, Inc., its affiliates, agents, and employees, and all persons acting on its or their behalf (collectively, "Vishay"), disclaim any and all liability for any errors, inaccuracies or incompleteness contained in any datasheet or in any other disclosure relating to any product.

Vishay makes no warranty, representation or guarantee regarding the suitability of the products for any particular purpose or the continuing production of any product. To the maximum extent permitted by applicable law, Vishay disclaims (i) any and all liability arising out of the application or use of any product, (ii) any and all liability, including without limitation special, consequential or incidental damages, and (iii) any and all implied warranties, including warranties of fitness for particular purpose, non-infringement and merchantability.

Statements regarding the suitability of products for certain types of applications are based on Vishay's knowledge of typical requirements that are often placed on Vishay products in generic applications. Such statements are not binding statements about the suitability of products for a particular application. It is the customer's responsibility to validate that a particular product with the properties described in the product specification is suitable for use in a particular application. Parameters provided in datasheets and / or specifications may vary in different applications and performance may vary over time. All operating parameters, including typical parameters, must be validated for each customer application by the customer's technical experts. Product specifications do not expand or otherwise modify Vishay's terms and conditions of purchase, including but not limited to the warranty expressed therein.

Hyperlinks included in this datasheet may direct users to third-party websites. These links are provided as a convenience and for informational purposes only. Inclusion of these hyperlinks does not constitute an endorsement or an approval by Vishay of any of the products, services or opinions of the corporation, organization or individual associated with the third-party website. Vishay disclaims any and all liability and bears no responsibility for the accuracy, legality or content of the third-party website or for that of subsequent links.

Vishay products are not designed for use in life-saving or life-sustaining applications or any application in which the failure of the Vishay product could result in personal injury or death unless specifically qualified in writing by Vishay. Customers using or selling Vishay products not expressly indicated for use in such applications do so at their own risk. Please contact authorized Vishay personnel to obtain written terms and conditions regarding products designed for such applications.

No license, express or implied, by estoppel or otherwise, to any intellectual property rights is granted by this document or by any conduct of Vishay. Product names and markings noted herein may be trademarks of their respective owners.