

Product Specification

NHD-C12832A1Z-FSR-FBW-3V3

COG (Chip-On-Glass) Liquid Crystal Display Module

NHD-	Newhaven Display
C12832-	128 x 32 Pixels
A1Z-	Model
F-	Transflective
SR-	Red LED Edge Backlight
F-	FSTN (+)
B-	6:00 Optimal View
W-	Wide Temperature
3V3-	3Vdd, 3V Backlight

Table of Contents

Document Revision History.....	2
Mechanical Drawing	3
Recommended PCB Footprint	4
Pin Description	5
Wiring Diagram	5
Electrical Characteristics	6
Optical Characteristics	6
Controller Information.....	6
Timing Characteristics.....	7
Table of Commands	8
Example Initialization Program	9
Quality Information	10

Additional Resources

- **Support Forum:** <https://support.newhavendisplay.com/hc/en-us/community/topics>
- **GitHub:** <https://github.com/newhavendisplay>
- **Example Code:** <https://support.newhavendisplay.com/hc/en-us/categories/4409527834135-Example-Code/>
- **Knowledge Center:** https://www.newhavendisplay.com/knowledge_center.html
- **Quality Center:** https://www.newhavendisplay.com/quality_center.html
- **Precautions for using LCDs/LCMs:** <https://www.newhavendisplay.com/specs/precautions.pdf>
- **Warranty / Terms & Conditions:** <https://www.newhavendisplay.com/terms.html>



Document Revision History

Revision	Date	Description	Changed By
0	11/12/2008	Initial Release	-
1	09/27/2010	User Guide Reformat	BE
2	05/06/2013	Electrical and Optical characteristics updated. Pin Description, Wiring Diagram, Mechanical Drawing Page and Example Initialization Program Updated.	JN
3	01/24/2017	Mechanical Drawing, Electrical & Optical Char. Updated	SB
4	07/05/2019	Added PCB Footprint Drawing	AS
5	01/30/2020	Glass Panel Updated	SB
6	06/17/2020	Updated 2D Mechanical Drawing & Quality Information	AS
7	04/14/2024	PCB Footprint Drawing Updated	KL
8	06/11/2024	Date Code Format Updated on Mechanical Drawing	KL

Mechanical Drawing

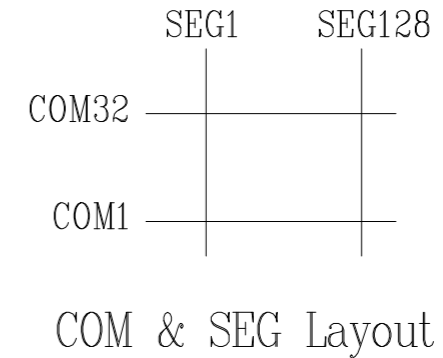
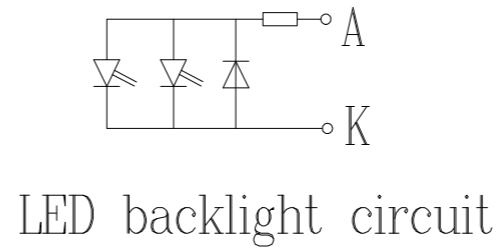
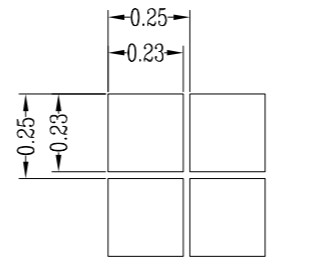
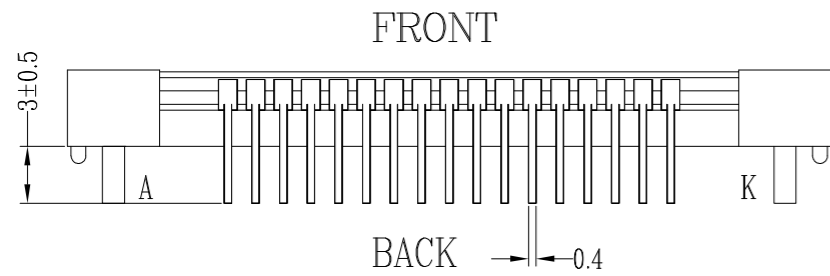
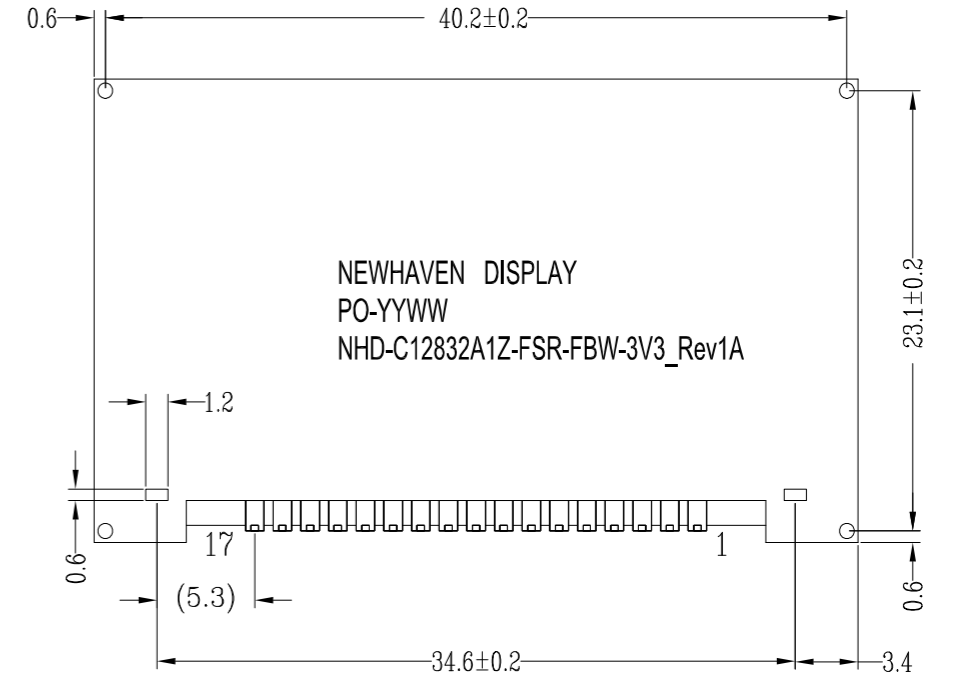
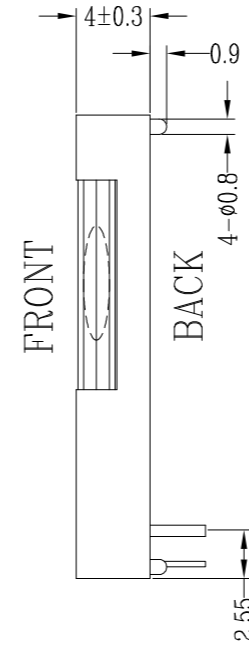
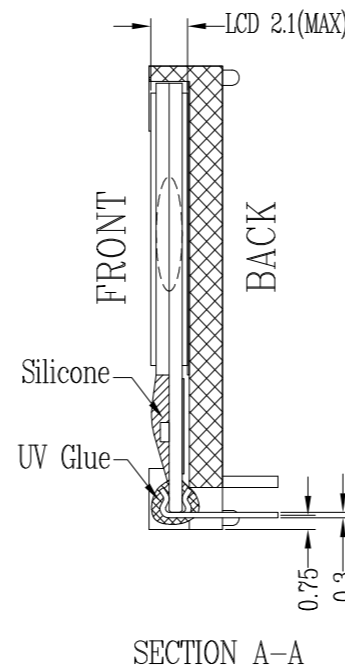
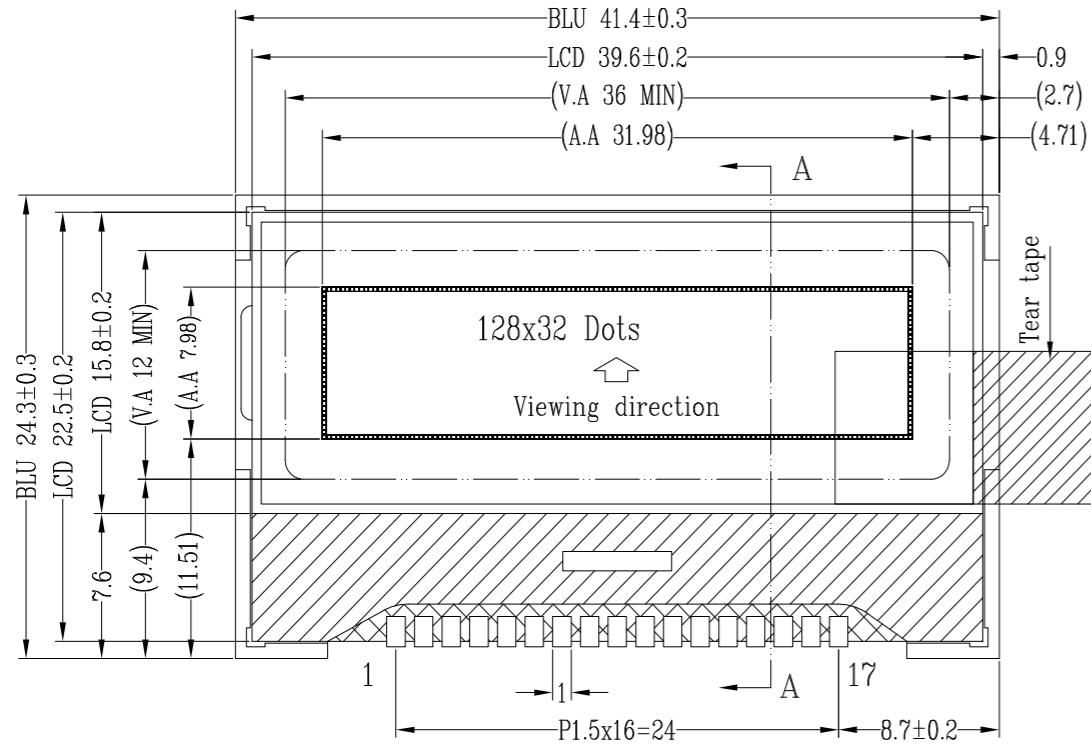

Pin Assignment	
NO.	Symbol
1	V0
2	V1
3	V2
4	V3
5	V4
6	C2-
7	C2+
8	C1+
9	C1-
10	VOUT
11	VSS
12	VDD
13	SI
14	SCL
15	A0
16	/RES
17	CS1B

Product Description: 128x32 Graphic COG LCD

1. Driver IC: ST7565R
2. Driving Mode: 1/33 Duty, 1/6 Bias
3. Interface: 4-Wire SPI
4. Power Requirement: 3.0V LCD
5. Optical Features: FSTN (+), Transflective, 6:00 View, Red Backlight



Standard Tolerance: (Unless otherwise specified) Linear: ±0.3mm		
	Drawing/Part Number: NHD-C12832A1Z-FSR-FBW-3V3	Revision: 1A
Unless otherwise specified: • Dimensions are in Millimeters • Third Angle Projection	Drawn By: K. Lewis	Approved By: K. Lewis
	Drawn Date: 06/11/2024	Approved Date: 06/11/2024
This drawing is solely the property of Newhaven Display International, Inc. The information it contains is not to be disclosed, reproduced or copied in whole or part without written approval from Newhaven Display.		

Mechanical Drawing

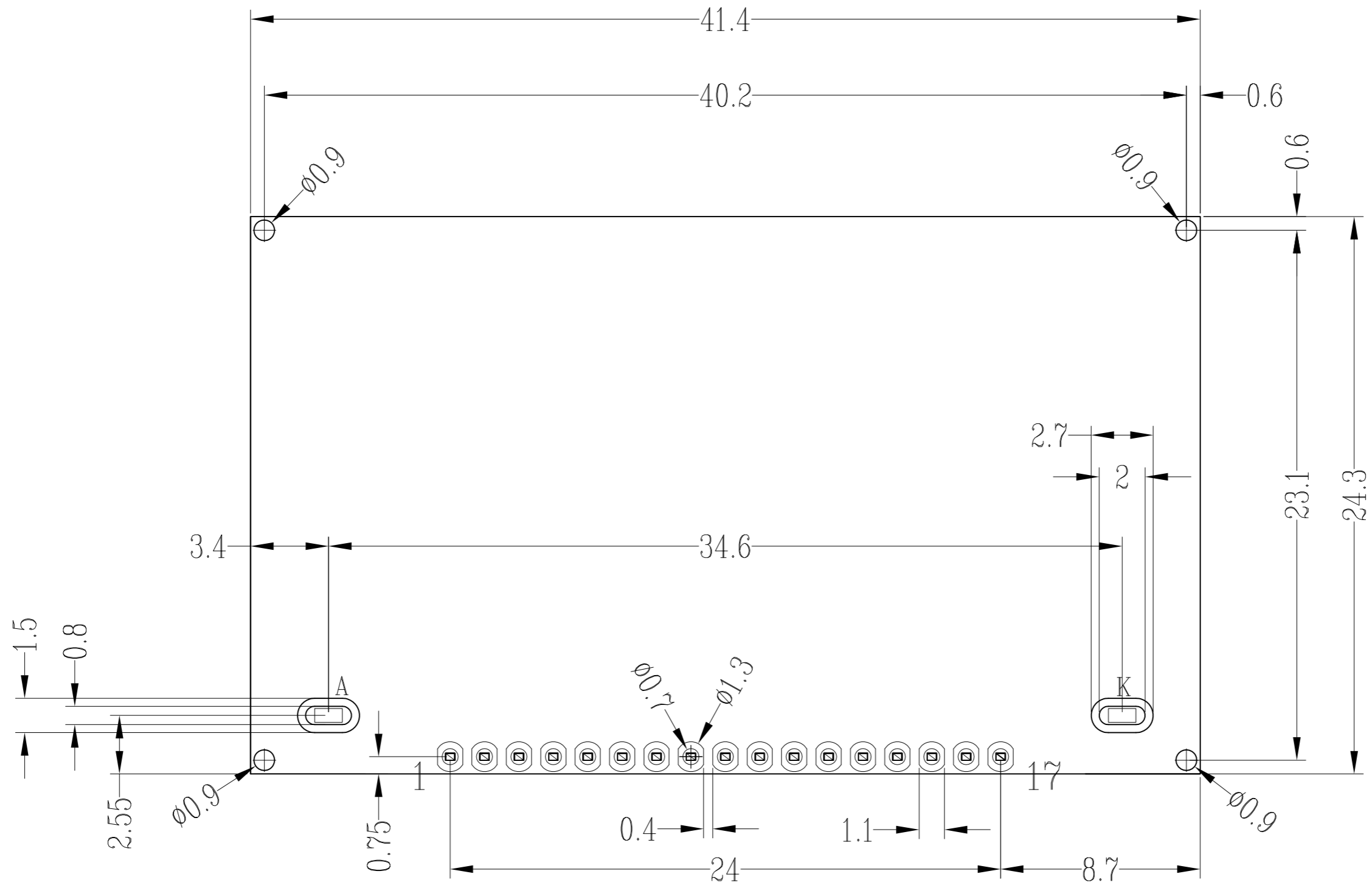
Recommended PCB Footprint



- Applicable Displays:**
- 1) NHD-C12832A1Z-FSW-FBW-3V3
 - 2) NHD-C12832A1Z-NSW-BBW-3V3
 - 3) NHD-C12832A1Z-FSR-FBW-3V3
 - 4) NHD-C12832A1Z-FSB-FBW-3V3

Standard Tolerance: (Unless otherwise specified) Linear: $\pm 0.3\text{mm}$		
	Drawing/Part Number: NHD-C12832A1Z-Monochrome-Footprint	Revision: -
Unless otherwise specified: • Dimensions are in Millimeters • Third Angle Projection 	Drawn By: K. Lewis	Approved By: K. Lewis
	Drawn Date: 04/09/2024	Approved Date: 04/09/2024
This drawing is solely the property of Newhaven Display International, Inc. The information it contains is not to be disclosed, reproduced or copied in whole or part without written approval from Newhaven Display.		

Pin Description

Pin No.	Symbol	External Connection	Function Description
1	V ₀	Power Supply	0.1μF – 1μF Capacitor to V _{SS}
2	V ₁	Power Supply	0.1μF – 1μF Capacitor to V _{SS}
3	V ₂	Power Supply	0.1μF – 1μF Capacitor to V _{SS}
4	V ₃	Power Supply	0.1μF – 1μF Capacitor to V _{SS}
5	V ₄	Power Supply	0.1μF – 1μF Capacitor to V _{SS}
6	C2-	Power Supply	Connect 1μF – 2.2μF Capacitor to C2+ (pin 7)
7	C2+	Power Supply	Connect 1μF – 2.2μF Capacitor to C2- (pin 6)
8	C1+	Power Supply	Connect 1μF – 2.2μF Capacitor to C1- (pin 9)
9	C1-	Power Supply	Connect 1μF – 2.2μF Capacitor to C1+ (pin 8)
10	V _{OUT}	Power Supply	Connect 1μF – 2.2μF Capacitor to V _{SS} (pin 11)
11	V _{SS}	Power Supply	Ground
12	V _{DD}	Power Supply	Supply Voltage for LCD and Logic (+3V)
13	SI	MPU	Serial Data
14	SCL	MPU	Serial Clock
15	A0	MPU	Register Select. A0=0: Instruction; A0=1: Data
16	/RST	MPU	Active LOW Reset signal
17	/CS1	MPU	Active LOW Chip Select signal
A	LED+	Power Supply	Backlight Anode (+3V)
K	LED-	Power Supply	Backlight Cathode (Ground)

Recommended LCD connector: 1.5mm pitch pins, solder directly into PCB

Backlight connector: 1.2mm Wide pins, solder directly into PCB **Mates with:** ---

Recommended Breakout Board: [NHD-PCB12832A1Z](#)

Wiring Diagram

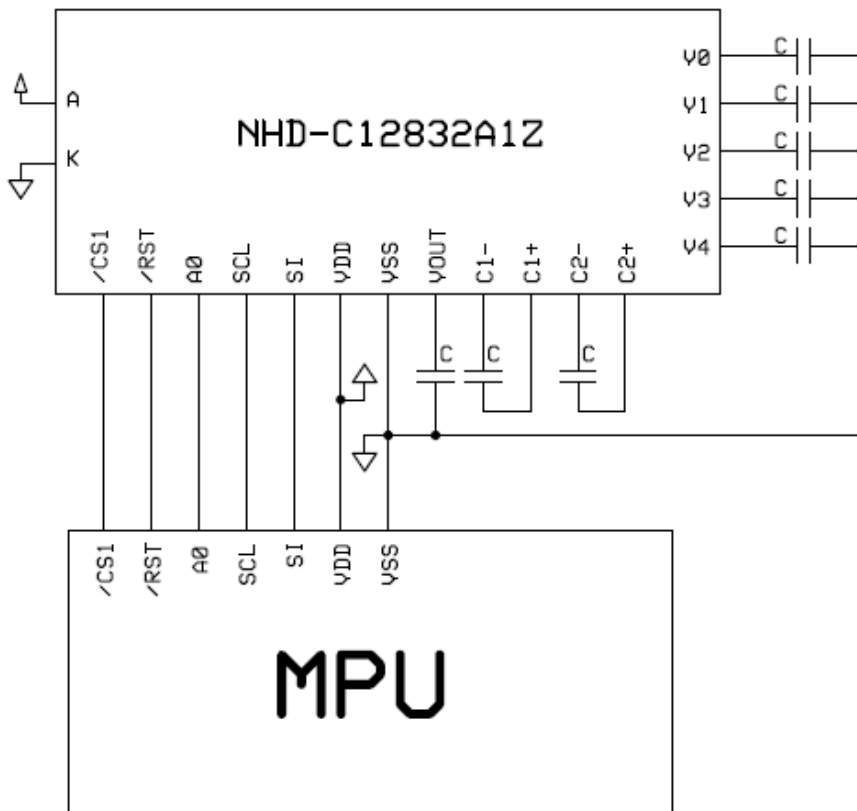

Electrical Characteristics

Item	Symbol	Condition	Min.	Typ.	Max.	Unit
Operating Temperature Range	T _{OP}	Absolute Max	-20	-	+70	°C
Storage Temperature Range	T _{ST}	Absolute Max	-30	-	+80	°C
Supply Voltage		-	2.7	3.0	3.3	V
Supply Current	I _{DD}	V _{DD} =3.0V	0.1	0.4	1.0	mA
Supply for LCD (contrast)	V _{LCD}	T _{OP} = 25°C	5.8	6.0	6.2	V
"H" Level input	V _{IH}	-	0.8 * V _{DD}	-	V _{DD}	V
"L" Level input	V _{IL}	-	V _{SS}	-	0.2 * V _{DD}	V
"H" Level output	V _{OH}	-	0.8 * V _{DD}	-	V _{DD}	V
"L" Level output	V _{OL}	-	V _{SS}	-	0.2 * V _{DD}	V
Backlight supply voltage	V _{LED}	-	2.9	3.0	3.1	V
Backlight supply current	I _{LED}	V _{LED} =3.0V	10	20	26	mA

Optical Characteristics

Item	Symbol	Condition	Min.	Typ.	Max.	Unit
Optimal Viewing Angles	Top	CR ≥ 2	-	20	-	°
	Bottom		-	40	-	°
	Left		-	40	-	°
	Right		-	40	-	°
Contrast Ratio	CR	-	2	8	-	-
Response Time	Rise	T _{OP} = 25°C	-	200	250	ms
	Fall		-	250	320	ms

Controller Information

Built-in ST7565R Controller: <https://support.newhavendisplay.com/hc/en-us/articles/4414899357591-ST7565R>



Timing Characteristics

The 4-line SPI Interface

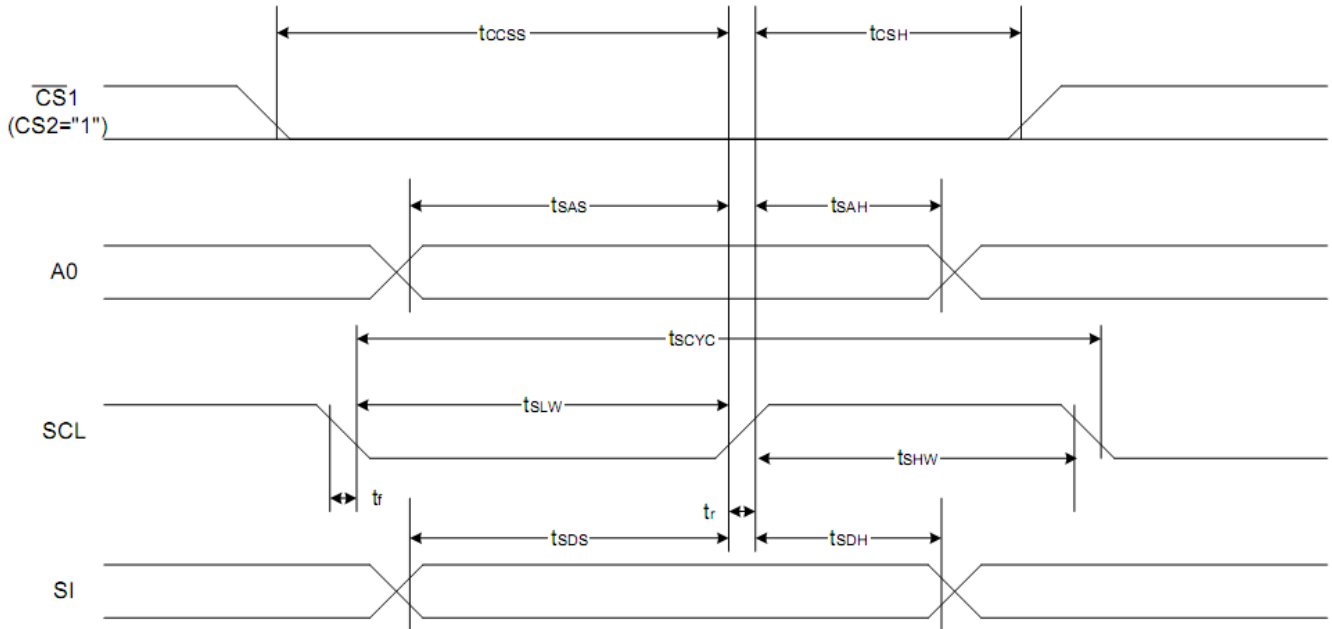

Item	Signal	Symbol	Condition	Rating		Units
				Min.	Max.	
4-line SPI Clock Period	SCL	T_{scyc}		50	—	ns
SCL "H" pulse width		T_{shw}		25	—	
SCL "L" pulse width		T_{SLW}		25	—	
Address setup time	A0	T_{sAS}		20	—	
Address hold time		T_{sah}		10	—	
Data setup time	SI	T_{sds}		20	—	
Data hold time		T_{sdH}		10	—	
CS-SCL time	CS	T_{css}		20	—	
CS-SCL time		T_{csh}		40	—	

*1 The input signal rise and fall time (t_r , t_f) are specified at 15 ns or less.

*2 All timing is specified using 20% and 80% of V_{DD} as the standard.

Reset Timing

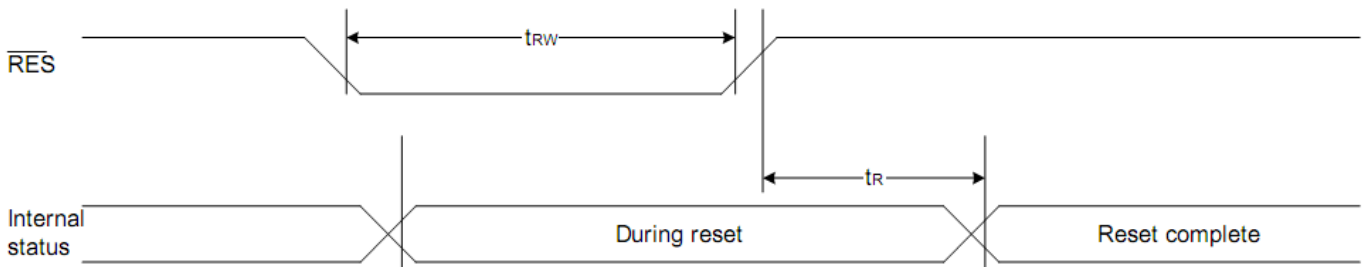

Table of Commands

Command	Command Code										Function	
	A0	/RD	/WR	D7	D6	D5	D4	D3	D2	D1		D0
(1) Display ON/OFF	0	1	0	1	0	1	0	1	1	1	0	LCD display ON/OFF 0: OFF, 1: ON
(2) Display start line set	0	1	0	0	1	Display start address					Sets the display RAM display start line address	
(3) Page address set	0	1	0	1	0	1	Page address				Sets the display RAM page address	
(4) Column address set upper bit	0	1	0	0	0	0	1	Most significant column address				Sets the most significant 4 bits of the display RAM column address.
Column address set lower bit				0	0	0	0	Least significant column address				Sets the least significant 4 bits of the display RAM column address.
(5) Status read	0	0	1	Status			0	0	0	0	Reads the status data	
(6) Display data write	1	1	0	Write data							Writes to the display RAM	
(7) Display data read	1	0	1	Read data							Reads from the display RAM	
(8) ADC select	0	1	0	1	0	1	0	0	0	0	0	Sets the display RAM address SEG output correspondence 0: normal, 1: reverse
(9) Display normal/reverse	0	1	0	1	0	1	0	0	1	1	0	Sets the LCD display normal/ reverse 0: normal, 1: reverse
(10) Display all points ON/OFF	0	1	0	1	0	1	0	0	1	0	0	Display all points 0: normal display 1: all points ON
(11) LCD bias set	0	1	0	1	0	1	0	0	0	1	0	Sets the LCD drive voltage bias ratio 0: 1/9 bias, 1: 1/7 bias (ST7565R)
(12) Read-modify-write	0	1	0	1	1	1	0	0	0	0	0	Column address increment At write: +1 At read: 0
(13) End	0	1	0	1	1	1	0	1	1	1	0	Clear read/modify/write
(14) Reset	0	1	0	1	1	1	0	0	0	1	0	Internal reset
(15) Common output mode select	0	1	0	1	1	0	0	0	*	*	*	Select COM output scan direction 0: normal direction 1: reverse direction
(16) Power control set	0	1	0	0	0	1	0	1	Operating mode		Select internal power supply operating mode	
(17) V ₀ voltage regulator internal resistor ratio set	0	1	0	0	0	1	0	0	Resistor ratio		Select internal resistor ratio(Rb/Ra) mode	
(18) Electronic volume mode set	0	1	0	1	0	0	0	0	0	0	1	Set the V ₀ output voltage electronic volume register
Electronic volume register set				0	0	Electronic volume value						
(19) Sleep mode set	0	1	0	1	0	1	0	1	1	0	0	0: Sleep mode, 1: Normal mode
(20) Booster ratio set	0	1	0	1	1	1	1	1	0	0	0	select booster ratio 00: 2x,3x,4x 01: 5x 11: 6x
(21) NOP	0	1	0	1	1	1	0	0	0	1	1	Command for non-operation
(22) Test	0	1	0	1	1	1	1	*	*	*	*	Command for IC test. Do not use this command

Example Initialization Program

```

void data_out(unsigned char i) //Data Output Serial Interface
{
    unsigned int n;
    CS = 0;
    A0 = 1;
    for(n=0; n<8; n++){
        i <<=1;
        SCL = 0;
        P1 = i;
        delay(2);
        SCL = 1;
    }
    CS = 1;
}

void comm_out(unsigned char j) //Command Output Serial Interface
{
    unsigned int n;
    CS = 0;
    A0 = 0;
    for(n=0; n<8; n++){
        j <<=1;
        SCL = 0;
        P1 = j;
        delay(2);
        SCL = 1;
    }
    CS = 1;
}

/*****
*      Initialization For controller      *
*****/
void init_LCD()
{
    comm_out(0xA0);
    comm_out(0xAE);
    comm_out(0xC0);
    comm_out(0xA2);
    comm_out(0x2F);
    comm_out(0x21);
    comm_out(0x81);
    comm_out(0x3F);
}
/*****/

```

Quality Information

Test Item	Content of Test	Test Condition	Note
High Temperature storage	Endurance test applying the high storage temperature for a long time.	+80°C, 96hrs	2
Low Temperature storage	Endurance test applying the low storage temperature for a long time.	-30°C, 96hrs	1,2
High Temperature Operation	Endurance test applying the electric stress (voltage & current) and the high thermal stress for a long time.	+70°C, 96hrs	2
Low Temperature Operation	Endurance test applying the electric stress (voltage & current) and the low thermal stress for a long time.	-20°C, 96hrs	1,2
High Temperature / Humidity Operation	Endurance test applying the electric stress (voltage & current) and the high thermal with high humidity stress for a long time.	+40°C, 90% RH, 96hrs	1,2
Thermal Shock resistance	Endurance test applying the electric stress (voltage & current) during a cycle of low and high thermal stress.	-20°C, 30min -> 70°C, 60min = 1 cycle For 20 cycles	
Vibration test	Endurance test applying vibration to simulate transportation and use.	10-50Hz, 5G amplitude. 30min in each of 3 directions X, Y, Z	3
Static electricity test	Endurance test applying electric static discharge.	Air: ±8kV 150pF/330Ω, 5 Times	
		Contact: ±4kV 150pF/330Ω, 5 Times	

Note 1: No condensation to be observed.

Note 2: Conducted after 4 hours of storage at 25°C, 0%RH.

Note 3: Test performed on product itself, not inside a container.