

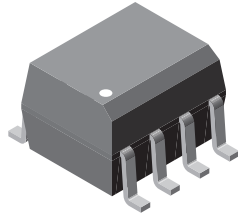

## Optocoupler, Phototransistor Output, Dual Channel, SOIC-8 Package

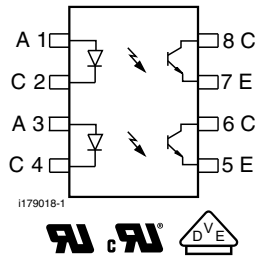

i179074



### FEATURES

- Dual channel coupler
- SOIC-8 surface mountable package
- Standard lead spacing of 0s.05"
- Available only on tape and reel option (conforms to EIA standard 481-2)
- Isolation test voltage, 4000 V<sub>RMS</sub>
- Compatible with dual wave, vapor phase and IR reflow soldering
- Material categorization: for definitions of compliance please see [www.vishay.com/doc?99912](http://www.vishay.com/doc?99912)



**RoHS**  
COMPLIANT

### LINKS TO ADDITIONAL RESOURCES



### DESCRIPTION

The VOD205T, VOD206T, VOD207T, VOD211T, VOD213T, VOD217T are optically coupled pairs with a GaAs infrared LED and a silicon NPN phototransistor. Signal information, including a DC level, can be transmitted by the device while maintaining a high degree of electrical isolation between input and output.

### AGENCY APPROVALS

- [UL](#)
- [cUL](#)
- [DIN EN 60747-5-5 \(VDE 0884-5\)](#), approved, contact customer service if this option is required

ORDERING INFORMATION						
V	O	D	2	#	#	T
PART NUMBER						
AGENCY CERTIFIED / PACKAGE	CTR (%)					
UL, cUL, VDE, CQC	40 to 80	63 to 125	100 to 200	> 20	> 100 <sup>(1)</sup>	> 100 <sup>(2)</sup>
SOIC-8	VOD205T	VOD206T	VOD207T	VOD211T	VOD213T	VOD217T

### Notes

- Additional options may be possible, please contact sales office.
- <sup>(1)</sup> I<sub>F</sub> = 10 mA
- <sup>(2)</sup> I<sub>F</sub> = 1 mA



ABSOLUTE MAXIMUM RATINGS (T <sub>amb</sub> = 25 °C, unless otherwise specified)				
PARAMETER	TEST CONDITION	SYMBOL	VALUE	UNIT
<b>INPUT</b>				
Peak reverse voltage		V <sub>R</sub>	6	V
Peak pulsed current	1 μs, 300 pps	I <sub>FM</sub>	1	A
Continuous forward current per channel		I <sub>F</sub>	30	mA
Power dissipation		P <sub>diss</sub>	50	mW
Derate linearly from 25 °C			0.66	mW/°C
<b>OUTPUT</b>				
Collector emitter breakdown voltage		BV <sub>CEO</sub>	70	V
Emitter collector breakdown voltage		BV <sub>ECO</sub>	7	V
Continuous output current		I <sub>Cmax.</sub>	50	mA
Power dissipation per channel		P <sub>diss</sub>	125	mW
Derate linearly from 25 °C			1.67	mW/°C
<b>COUPLER</b>				
Isolation test voltage	t = 1 s	V <sub>ISO</sub>	4000	V <sub>RMS</sub>
Total package dissipation ambient (2 LEDs and 2 detectors, 2 channels)		P <sub>tot</sub>	300	mW
Derate linearly from 25 °C			4	mW/°C
Storage temperature		T <sub>stg</sub>	-40 to +150	°C
Operating temperature		T <sub>amb</sub>	-40 to +100	°C
Soldering time from 260 °C <sup>(1)</sup>		T <sub>sld</sub>	10	s

Notes

- Stresses in excess of the absolute maximum ratings can cause permanent damage to the device. Functional operation of the device is not implied at these or any other conditions in excess of those given in the operational sections of this document. Exposure to absolute maximum ratings for extended periods of the time can adversely affect reliability.
- Refer to reflow profile for soldering conditions for surface mounted devices

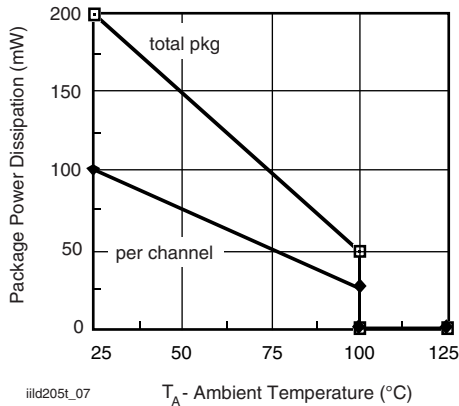

Fig. 1 - Power Dissipation vs. Ambient Temperature



ELECTRICAL CHARACTERISTICS (T <sub>amb</sub> = 25 °C, unless otherwise specified)							
PARAMETER	TEST CONDITION	PART	SYMBOL	MIN.	TYP.	MAX.	UNIT
<b>INPUT</b>							
Forward voltage	I <sub>F</sub> = 10 mA		V <sub>F</sub>	-	1.2	1.55	V
Reverse current	V <sub>R</sub> = 6 V		I <sub>R</sub>	-	0.1	100	μA
Capacitance	V <sub>R</sub> = 0 V		C <sub>O</sub>	-	25	-	pF
<b>OUTPUT</b>							
Collector emitter breakdown voltage	I <sub>C</sub> = 100 μA		BV <sub>CEO</sub>	70	-	-	V
Emitter collector breakdown voltage	I <sub>E</sub> = 100 μA		BV <sub>ECO</sub>	7	-	-	V
Collector emitter leakage current	V <sub>CE</sub> = 10 V, I <sub>F</sub> = 0 A		I <sub>CCEO</sub>	-	5	50	nA
Collector emitter capacitance	V <sub>CE</sub> = 0 V		C <sub>CCE</sub>	-	10	-	pF
Collector emitter saturation voltage	I <sub>F</sub> = 10 mA, I <sub>C</sub> = 2.5 mA		V <sub>CEsat</sub>	-	-	0.4	V
<b>COUPLER</b>							
Capacitance (input to output)			C <sub>IO</sub>	-	0.5	-	pF

**Note**

- Minimum and maximum values were tested requirements. Typical values are characteristics of the device and are the result of engineering evaluations. Typical values are for information only and are not part of the testing requirements.

CURRENT TRANSFER RATIO							
PARAMETER	TEST CONDITION	PART	SYMBOL	MIN.	TYP.	MAX.	UNIT
I <sub>C</sub> /I <sub>F</sub>	V <sub>CE</sub> = 5 V, I <sub>F</sub> = 10 mA	VOD205T	CTR <sub>DC</sub>	40	-	80	%
		VOD206T	CTR <sub>DC</sub>	63	-	125	%
		VOD207T	CTR <sub>DC</sub>	100	-	200	%
		VOD211T	CTR <sub>DC</sub>	20	-	-	%
		VOD213T	CTR <sub>DC</sub>	100	-	-	%
	V <sub>CE</sub> = 5 V, I <sub>F</sub> = 1 mA	VOD205T	CTR <sub>DC</sub>	13	30	-	%
		VOD206T	CTR <sub>DC</sub>	22	45	-	%
		VOD207T	CTR <sub>DC</sub>	34	70	-	%
		VOD217T	CTR <sub>DC</sub>	100	120	-	%

SWITCHING CHARACTERISTICS							
PARAMETER	TEST CONDITION	SYMBOL	MIN.	TYP.	MAX.	UNIT	
Turn-on time	I <sub>C</sub> = 2 mA, R <sub>L</sub> = 100 Ω, V <sub>CC</sub> = 5 V	t <sub>on</sub>	-	5	-	μs	
Turn-off time	I <sub>C</sub> = 2 mA, R <sub>L</sub> = 100 Ω, V <sub>CC</sub> = 5 V	t <sub>off</sub>	-	4	-	μs	
Rise time	I <sub>C</sub> = 2 mA, R <sub>L</sub> = 100 Ω, V <sub>CC</sub> = 5 V	t <sub>r</sub>	-	5	-	μs	
Fall time	I <sub>C</sub> = 2 mA, R <sub>L</sub> = 100 Ω, V <sub>CC</sub> = 5 V	t <sub>f</sub>	-	4	-	μs	

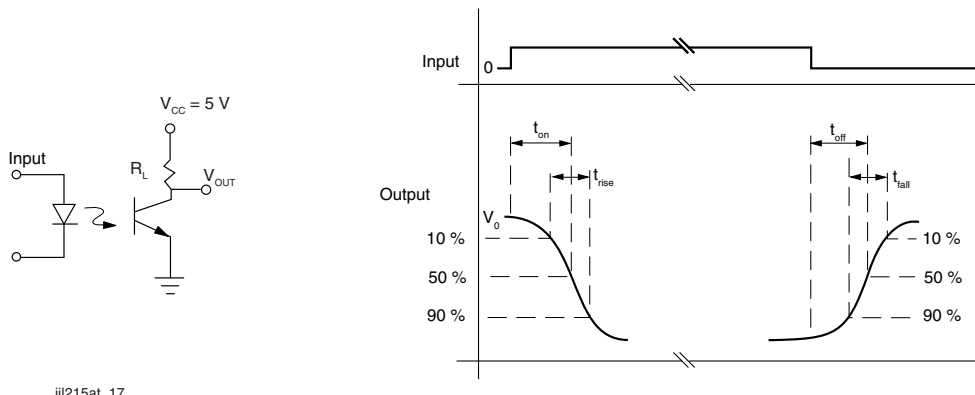

Fig. 2 - Switching Test Circuit

COMMON MODE TRANSIENT IMMUNITY						
PARAMETER	TEST CONDITION	SYMBOL	MIN.	TYP.	MAX.	UNIT
Common mode transient immunity at logic high	$V_{CM} = 1000 V_{P-P}$ , $R_L = 1 k\Omega$ , $I_F = 0 mA$	$ C_{MH} $	-	10 000	-	$V/\mu s$
Common mode transient immunity at logic low	$V_{CM} = 1000 V_{P-P}$ , $R_L = 1 k\Omega$ , $I_F = 10 mA$	$ C_{ML} $	-	10 000	-	$V/\mu s$

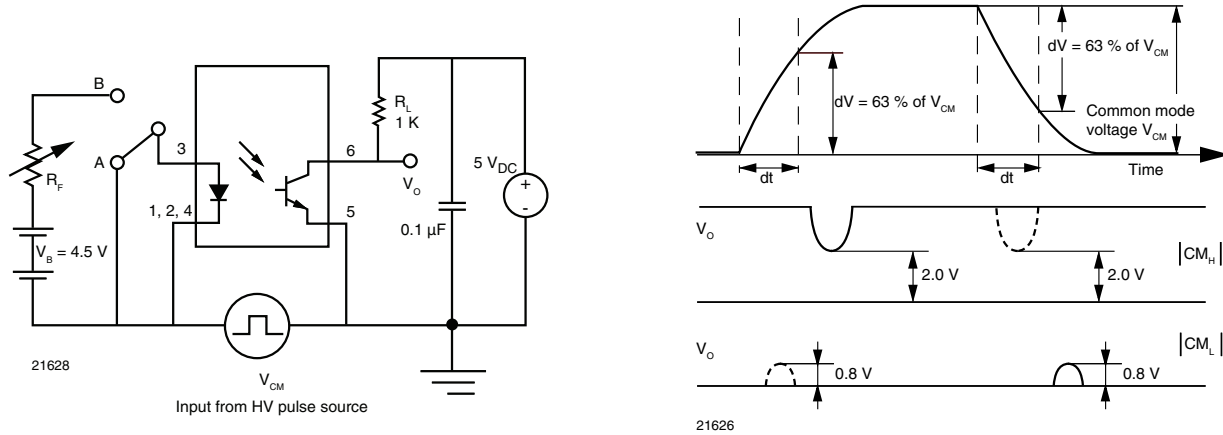

Fig. 3 - Test Circuit for Common Mode Transient Immunity

SAFETY AND INSULATION RATINGS ( $T_{amb} = 25\text{ }^{\circ}\text{C}$ , unless otherwise specified)				
PARAMETER	TEST CONDITION	SYMBOL	VALUE	UNIT
Climatic classification	According to IEC 68 part 1		40 / 100 / 21	
Pollution degree	According to DIN VDE 0109		2	
Comparative tracking index	Insulation group IIIa	CTI	175	
Maximum rated withstanding isolation voltage	According to UL1577, $t = 1 \text{ min}$	$V_{ISO}$	3333	$V_{RMS}$
Tested withstanding isolation voltage	According to UL1577, $t = 1 \text{ s}$	$V_{ISO}$	4000	$V_{RMS}$
Maximum transient isolation voltage	According to DIN EN 60747-5-5	$V_{IOTM}$	6000	$V_{peak}$
Maximum repetitive peak isolation voltage	According to DIN EN 60747-5-5	$V_{IORM}$	560	$V_{peak}$
Isolation resistance	$T_{amb} = 25\text{ }^{\circ}\text{C}$ , $V_{IO} = 500 \text{ V}$	$R_{IO}$	$\geq 10^{12}$	$\Omega$
	$T_{amb} = 100\text{ }^{\circ}\text{C}$ , $V_{IO} = 500 \text{ V}$	$R_{IO}$	$\geq 10^{11}$	$\Omega$
Output safety power		$P_{SO}$	350	mW
Input safety current		$I_{SI}$	150	mA
Input safety temperature		$T_S$	165	$^{\circ}\text{C}$
Creepage distance			$\geq 4$	mm
Clearance distance			$\geq 4$	mm
Insulation thickness		DTI	$\geq 0.2$	mm

**Note**

- As per IEC 60747-5-5, §7.4.3.8.2, this optocoupler is suitable for “safe electrical insulation” only within the safety ratings. Compliance with the safety ratings shall be ensured by means of protective circuits.

**TYPICAL CHARACTERISTICS** ( $T_{amb} = 25\text{ }^{\circ}\text{C}$ , unless otherwise specified)

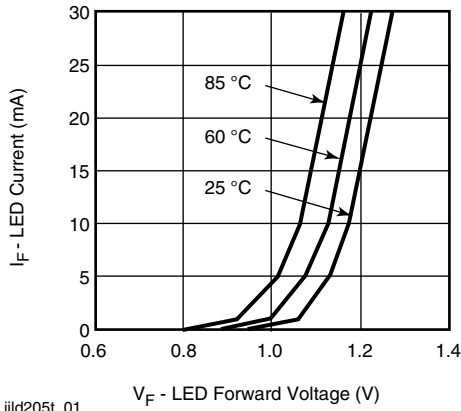

iiid205t\_01

Fig. 4 - Forward Current vs. Forward Voltage

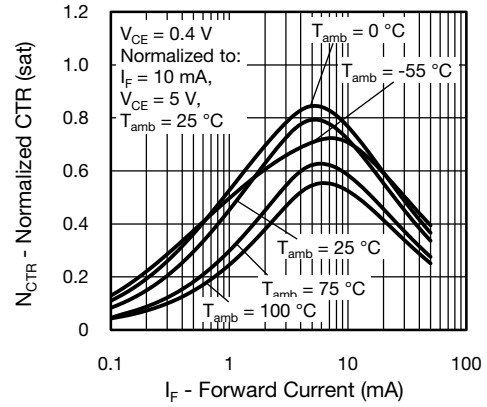
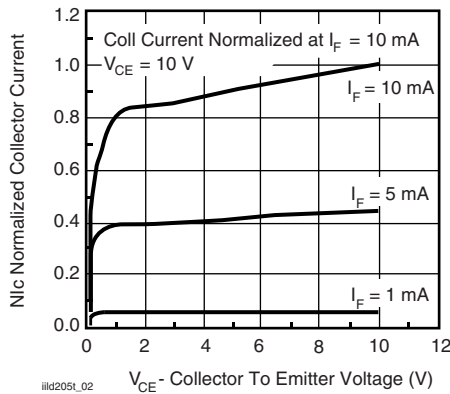
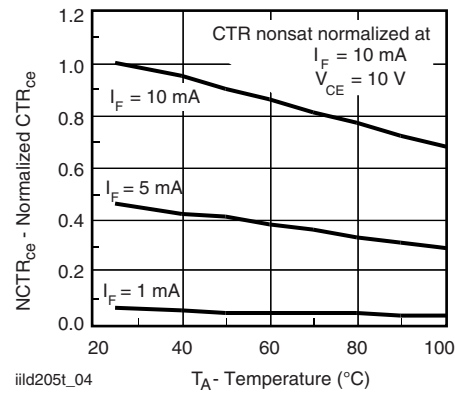

Fig. 7 - Normalized CTR (saturated) vs. Forward Current



iiid205t\_02

Fig. 5 - Collector Emitter Current vs.  $V_{CE}$



iiid205t\_04

Fig. 8 - Current Transfer Ratio (normalized) vs. Ambient Temperature

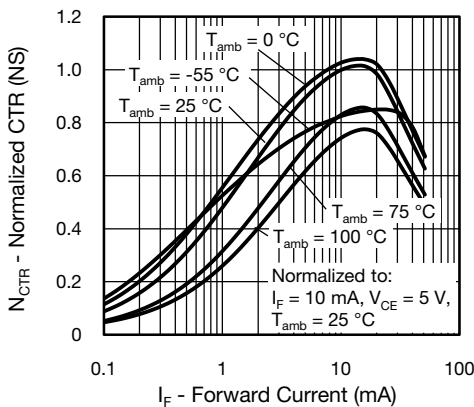
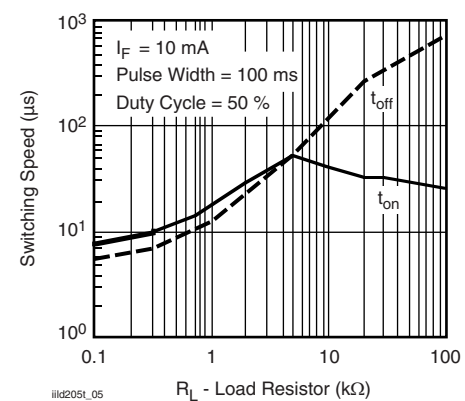

Fig. 6 - Normalized CTR (non-saturated) vs. Forward Current



iiid205t\_05

Fig. 9 - Switching Speed vs. Load Resistor

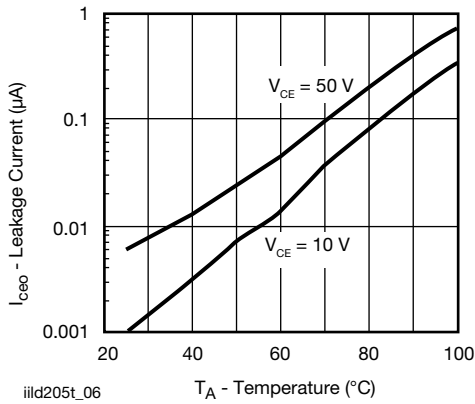
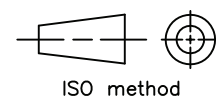
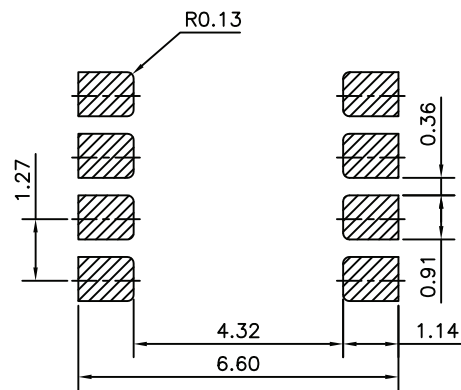
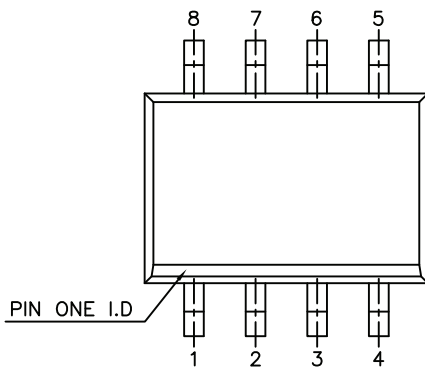
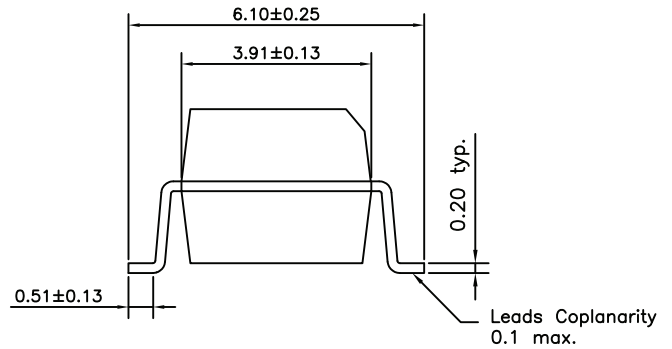
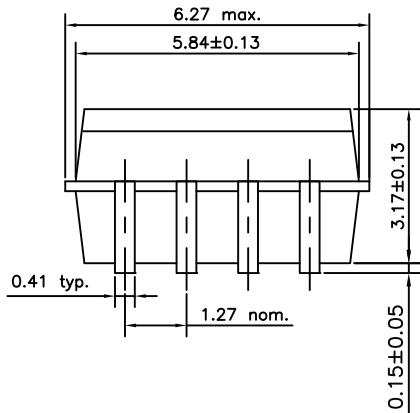
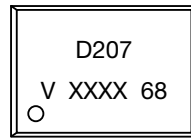

Fig. 10 - Collector Current vs. Ambient Temperature

### PACKAGE DIMENSIONS (in millimeters)



## PACKAGE MARKING (example of VOD207T)



### Notes

- XXXX = LMC (lot marking code)
- Tape and reel suffix (T) is not part of the package marking

## TAPE AND REEL PACKAGING

Dimensions in millimeters

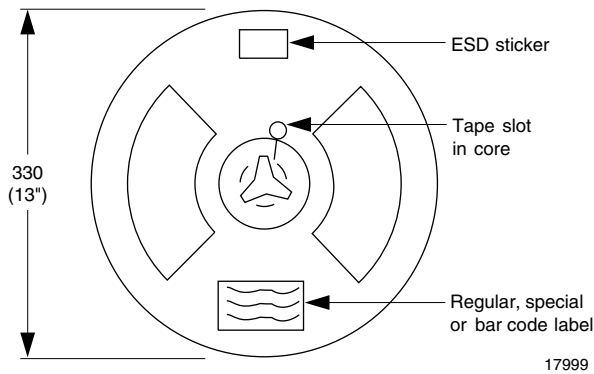

17999

Fig. 11 - Tape and Reel Shipping Medium (EIA-481, revision A, and IEC 60286), 2000 Units per Reel

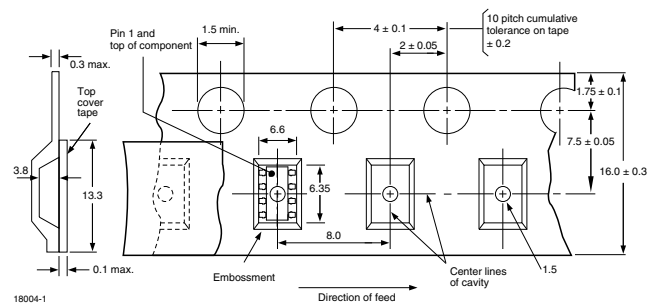
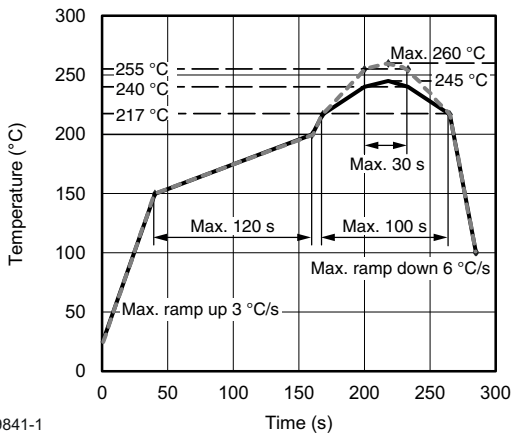

Fig. 12 - Tape Dimensions, 2000 Parts per Reel

## SOLDER PROFILE



19841-1

Fig. 13 - Lead (Pb)-free Reflow Solder Profile according to J-STD-020

## HANDLING AND STORAGE CONDITIONS

ESD level: HBM class 2

Floor life: unlimited

Conditions:  $T_{amb} < 30\text{ }^{\circ}\text{C}$ , RH < 85 %

Moisture sensitivity level 1, according to J-STD-020



## Disclaimer

ALL PRODUCT, PRODUCT SPECIFICATIONS AND DATA ARE SUBJECT TO CHANGE WITHOUT NOTICE TO IMPROVE RELIABILITY, FUNCTION OR DESIGN OR OTHERWISE.

Vishay Intertechnology, Inc., its affiliates, agents, and employees, and all persons acting on its or their behalf (collectively, "Vishay"), disclaim any and all liability for any errors, inaccuracies or incompleteness contained in any datasheet or in any other disclosure relating to any product.

Vishay makes no warranty, representation or guarantee regarding the suitability of the products for any particular purpose or the continuing production of any product. To the maximum extent permitted by applicable law, Vishay disclaims (i) any and all liability arising out of the application or use of any product, (ii) any and all liability, including without limitation special, consequential or incidental damages, and (iii) any and all implied warranties, including warranties of fitness for particular purpose, non-infringement and merchantability.

Statements regarding the suitability of products for certain types of applications are based on Vishay's knowledge of typical requirements that are often placed on Vishay products in generic applications. Such statements are not binding statements about the suitability of products for a particular application. It is the customer's responsibility to validate that a particular product with the properties described in the product specification is suitable for use in a particular application. Parameters provided in datasheets and / or specifications may vary in different applications and performance may vary over time. All operating parameters, including typical parameters, must be validated for each customer application by the customer's technical experts. Product specifications do not expand or otherwise modify Vishay's terms and conditions of purchase, including but not limited to the warranty expressed therein.

Hyperlinks included in this datasheet may direct users to third-party websites. These links are provided as a convenience and for informational purposes only. Inclusion of these hyperlinks does not constitute an endorsement or an approval by Vishay of any of the products, services or opinions of the corporation, organization or individual associated with the third-party website. Vishay disclaims any and all liability and bears no responsibility for the accuracy, legality or content of the third-party website or for that of subsequent links.

Vishay products are not designed for use in life-saving or life-sustaining applications or any application in which the failure of the Vishay product could result in personal injury or death unless specifically qualified in writing by Vishay. Customers using or selling Vishay products not expressly indicated for use in such applications do so at their own risk. Please contact authorized Vishay personnel to obtain written terms and conditions regarding products designed for such applications.

No license, express or implied, by estoppel or otherwise, to any intellectual property rights is granted by this document or by any conduct of Vishay. Product names and markings noted herein may be trademarks of their respective owners.