

## Optocoupler, Phototransistor Output, no Base Connection, 110 °C Rated



i179004-14



### FEATURES

- Operating temperature from -55 °C to +110 °C
- No base terminal connection for improved common mode interface immunity
- Long term stability
- Industry standard dual-in-line package
- Material categorization: For definitions of compliance please see [www.vishay.com/doc?99912](http://www.vishay.com/doc?99912)



**RoHS**  
COMPLIANT

### APPLICATIONS

- AC adapter
- SMPS
- PLC
- Factory automation
- Game consoles

### AGENCY APPROVALS

- UL file no. E52744
- cUL tested to CSA 22.2 bulletin 5A
- DIN EN 60747-5-5 (VDE 0884-5), available with option 1
- BSI: EN 60065, EN 60950-1
- FIMKO EN60950
- CQC GB8898-2011

### DESCRIPTION

The CNY117F is a 110 °C rated optocoupler consisting of a gallium arsenide infrared emitting diode optically coupled to a silicon planar phototransistor detector in a plastic plug-in DIP-6 package.

The coupling device is suitable for signal transmission between two electrically separated circuits. The potential difference between the circuits to be coupled is not allowed to exceed the maximum permissible reference voltages.

In contrast to the CNY117 series, the base terminal of the F type is not connected, resulting in a substantially improved common-mode interference immunity.

ORDERING INFORMATION				
<div style="display: flex; justify-content: space-around;"> <div style="border: 1px solid black; padding: 2px;">C</div> <div style="border: 1px solid black; padding: 2px;">N</div> <div style="border: 1px solid black; padding: 2px;">Y</div> <div style="border: 1px solid black; padding: 2px;">1</div> <div style="border: 1px solid black; padding: 2px;">1</div> <div style="border: 1px solid black; padding: 2px;">7</div> <div style="border: 1px solid black; padding: 2px;">F</div> </div> <p style="text-align: center;">PART NUMBER</p>	<div style="border: 1px solid black; padding: 2px;">-</div> <div style="border: 1px solid black; padding: 2px;">#</div> <p style="text-align: center;">CTR BIN</p>	<div style="display: flex; justify-content: space-around;"> <div style="border: 1px solid black; padding: 2px;">X</div> <div style="border: 1px solid black; padding: 2px;">0</div> <div style="border: 1px solid black; padding: 2px;">#</div> <div style="border: 1px solid black; padding: 2px;">#</div> </div> <p style="text-align: center;">PACKAGE OPTION</p>	<div style="border: 1px solid black; padding: 2px;">T</div> <p style="text-align: center;">TAPE AND REEL</p>	<div style="display: flex; justify-content: space-around;"> <div style="text-align: center;"> <p>DIP-6</p> <p>7.62 mm</p> </div> <div style="text-align: center;"> <p>Option 6</p> <p>10.16 mm</p> </div> </div> <div style="text-align: center; margin-top: 10px;"> <p>Option 7</p> <p>&gt; 8 mm</p> </div>
AGENCY CERTIFIED/PACKAGE	CTR (%)			
UL, cUL, BSI	40 to 80	63 to 125	100 to 200	160 to 320
DIP-6	CNY117F-1	CNY117F-2	CNY117F-3	CNY117F-4
DIP-6, 400 mil, option 6	CNY117F-1X006	CNY117F-2X006	CNY117F-3X006	CNY117F-4X006
SMD-6, option 7	CNY117F-1X007T	CNY117F-2X007T	CNY117F-3X007T	CNY117F-4X007T
VDE, UL, cUL, BSI	40 to 80	63 to 125	100 to 200	160 to 320
DIP-6	CNY117F-1X001	CNY117F-2X001	CNY117F-3X001	CNY117F-4X001
DIP-6, 400 mil, option 6	CNY117F-1X016	CNY117F-2X016	CNY117F-3X016	CNY117F-4X016
SMD-6, option 7	CNY117F-1X017T	CNY117F-2X017T	CNY117F-3X017T	CNY117F-4X017T

### Note

- Additional options may be possible, please contact sales office.

<b>ABSOLUTE MAXIMUM RATINGS</b> ( $T_{amb} = 25\text{ }^{\circ}\text{C}$ , unless otherwise specified)				
PARAMETER	TEST CONDITION	SYMBOL	VALUE	UNIT
<b>INPUT</b>				
Reverse voltage		$V_R$	6.0	V
DC forward current		$I_F$	60	mA
Surge forward current	$t \leq 10\text{ }\mu\text{s}$	$I_{FSM}$	2.5	A
Power dissipation		$P_{diss}$	100	mW
<b>OUTPUT</b>				
Collector emitter breakdown voltage		$BV_{CEO}$	70	V
Collector current		$I_C$	50	mA
Collector peak current	$t_p/T = 0.5, t_p \leq 10\text{ ms}$	$I_{CM}$	100	mA
Output power dissipation		$P_{diss}$	150	mW
<b>COUPLER</b>				
Isolation test voltage between emitter and detector	$t = 1\text{ min}$	$V_{ISO}$	5000	$V_{RMS}$
Storage temperature range		$T_{stg}$	-55 to +150	$^{\circ}\text{C}$
Ambient temperature range		$T_{amb}$	-55 to +110	$^{\circ}\text{C}$
Soldering temperature <sup>(1)</sup>	2 mm from case, $\leq 10\text{ s}$	$T_{sld}$	260	$^{\circ}\text{C}$
Total power dissipation		$P_{diss}$	250	mW

**Notes**

- Stresses in excess of the absolute maximum ratings can cause permanent damage to the device. Functional operation of the device is not implied at these or any other conditions in excess of those given in the operational sections of this document. Exposure to absolute maximum ratings for extended periods of the time can adversely affect reliability.
- <sup>(1)</sup> Refer to reflow profile for soldering conditions for surface mounted devices (SMD). Refer to wave profile for soldering conditions for through hole devices (DIP).



Fig. 1 - Total Power Dissipation vs. Ambient Temperature

<b>ELECTRICAL CHARACTERISTICS</b> ( $T_{amb} = 25\text{ }^{\circ}\text{C}$ , unless otherwise specified)							
PARAMETER	TEST CONDITION	PART	SYMBOL	MIN.	TYP.	MAX.	UNIT
<b>INPUT</b>							
Forward voltage	$I_F = 60\text{ mA}$		$V_F$		1.39	1.65	V
Breakdown voltage	$I_R = 10\text{ }\mu\text{A}$		$V_{BR}$	6.0			V
Reverse current	$V_R = 6.0\text{ V}$		$I_R$		0.01	10	$\mu\text{A}$
Capacitance	$V_R = 0\text{ V}, f = 1.0\text{ MHz}$		$C_O$		25		pF
<b>OUTPUT</b>							
Collector emitter capacitance	$V_{CE} = 5.0\text{ V}, f = 1.0\text{ MHz}$		$C_{CE}$		5.2		pF
Base collector capacitance	$V_{CE} = 5.0\text{ V}, f = 1.0\text{ MHz}$		$C_{BC}$		6.5		pF
Emitter base capacitance	$V_{CE} = 5.0\text{ V}, f = 1.0\text{ MHz}$		$C_{EB}$		7.5		pF



<b>ELECTRICAL CHARACTERISTICS</b> ( $T_{amb} = 25\text{ }^{\circ}\text{C}$ , unless otherwise specified)							
PARAMETER	TEST CONDITION	PART	SYMBOL	MIN.	TYP.	MAX.	UNIT
<b>COUPLER</b>							
Collector emitter, saturation voltage	$I_F = 10\text{ mA}$ , $I_C = 2.5\text{ mA}$		$V_{CEsat}$		0.25	0.4	V
Coupling capacitance			$C_C$		0.6		pF
Collector emitter, leakage current	$V_{CE} = 10\text{ V}$	CNY117F-1	$I_{CEO}$		2.0	50	nA
		CNY117F-2	$I_{CEO}$		2.0	50	nA
		CNY117F-3	$I_{CEO}$		5.0	100	nA
		CNY117F-4	$I_{CEO}$		5.0	100	nA

**Note**

- Minimum and maximum values were tested requirements. Typical values are characteristics of the device and are the result of engineering evaluations. Typical values are for information only and are not part of the testing requirements.

<b>CURRENT TRANSFER RATIO</b> ( $T_{amb} = 25\text{ }^{\circ}\text{C}$ , unless otherwise specified)							
PARAMETER	TEST CONDITION	PART	SYMBOL	MIN.	TYP.	MAX.	UNIT
Current transfer ratio	$I_F = 10\text{ mA}$	CNY117F-1	CTR	40		80	%
		CNY117F-2	CTR	63		125	%
		CNY117F-3	CTR	100		200	%
		CNY117F-4	CTR	160		320	%
	$I_F = 1.0\text{ mA}$	CNY117F-1	CTR	13	30		%
		CNY117F-2	CTR	22	45		%
		CNY117F-3	CTR	34	70		%
		CNY117F-4	CTR	56	90		%

**Note**

- Current transfer ratio  $I_C/I_F$  at  $V_{CE} = 5.0\text{ V}$ ,  $25\text{ }^{\circ}\text{C}$  and collector emitter leakage current by dash number.

<b>SWITCHING CHARACTERISTICS</b> ( $T_{amb} = 25\text{ }^{\circ}\text{C}$ , unless otherwise specified)							
PARAMETER	TEST CONDITION	PART	SYMBOL	MIN.	TYP.	MAX.	UNIT
<b>LINEAR OPERATION</b> (without saturation)							
Turn-on time	$I_F = 10\text{ mA}$ , $V_{CC} = 5.0\text{ V}$ , $R_L = 75\text{ }\Omega$		$t_{on}$		3.0		$\mu\text{s}$
Rise time	$I_F = 10\text{ mA}$ , $V_{CC} = 5.0\text{ V}$ , $R_L = 75\text{ }\Omega$		$t_r$		2.0		$\mu\text{s}$
Turn-off time	$I_F = 10\text{ mA}$ , $V_{CC} = 5.0\text{ V}$ , $R_L = 75\text{ }\Omega$		$t_{off}$		2.3		$\mu\text{s}$
Fall time	$I_F = 10\text{ mA}$ , $V_{CC} = 5.0\text{ V}$ , $R_L = 75\text{ }\Omega$		$t_f$		2.0		$\mu\text{s}$
Cut-off frequency	$I_F = 10\text{ mA}$ , $V_{CC} = 5.0\text{ V}$ , $R_L = 75\text{ }\Omega$		$f_{CO}$		110		kHz
<b>SWITCHING OPERATION</b> (with saturation)							
Turn-on time	$I_F = 20\text{ mA}$	CNY117F-1	$t_{on}$		3.0		$\mu\text{s}$
	$I_F = 10\text{ mA}$	CNY117F-2	$t_{on}$		4.2		$\mu\text{s}$
		CNY117F-3	$t_{on}$		4.2		$\mu\text{s}$
	$I_F = 5.0\text{ mA}$	CNY117F-4	$t_{on}$		6.0		$\mu\text{s}$
Rise time	$I_F = 20\text{ mA}$	CNY117F-1	$t_r$		2.0		$\mu\text{s}$
	$I_F = 10\text{ mA}$	CNY117F-2	$t_r$		3.0		$\mu\text{s}$
		CNY117F-3	$t_r$		3.0		$\mu\text{s}$
	$I_F = 5.0\text{ mA}$	CNY117F-4	$t_r$		4.6		$\mu\text{s}$
Turn-off time	$I_F = 20\text{ mA}$	CNY117F-1	$t_{off}$		18		$\mu\text{s}$
	$I_F = 10\text{ mA}$	CNY117F-2	$t_{off}$		23		$\mu\text{s}$
		CNY117F-3	$t_{off}$		23		$\mu\text{s}$
	$I_F = 5.0\text{ mA}$	CNY117F-4	$t_{off}$		25		$\mu\text{s}$
Fall time	$I_F = 20\text{ mA}$	CNY117F-1	$t_f$		11		$\mu\text{s}$
	$I_F = 10\text{ mA}$	CNY117F-2	$t_f$		14		$\mu\text{s}$
		CNY117F-3	$t_f$		14		$\mu\text{s}$
	$I_F = 5.0\text{ mA}$	CNY117F-4	$t_f$		15		$\mu\text{s}$

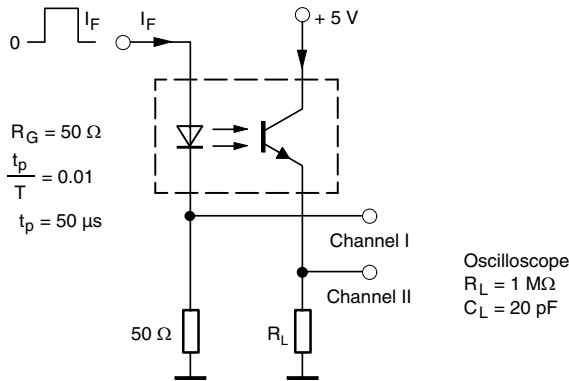

95 10804-3

Fig. 2 - Test Circuit, Non-Saturated Operation



95 10843

Fig. 3 - Test Circuit, Saturated Operation



Fig. 4 - Switching Times

SAFETY AND INSULATION RATINGS				
PARAMETER		SYMBOL	VALUE	UNIT
<b>MAXIMUM SAFETY RATINGS</b>				
Output safety power		P <sub>SO</sub>	700	mW
Input safety current		I <sub>SI</sub>	400	mA
Safety temperature		T <sub>SI</sub>	175	°C
Comparative tracking index		CTI	175	
<b>INSULATION RATED PARAMETERS</b>				
Maximum withstanding isolation voltage		V <sub>ISO</sub>	5000	V <sub>RMS</sub>
Maximum transient isolation voltage		V <sub>IOTM</sub>	8000	V <sub>peak</sub>
Maximum repetitive peak isolation voltage		V <sub>IORM</sub>	890	V <sub>peak</sub>
Insulation resistance	T <sub>amb</sub> = 25 °C, V <sub>DC</sub> = 500 V	R <sub>IO</sub>	≥ 10 <sup>12</sup>	Ω
Insulation resistance	T <sub>amb</sub> = 100 °C, V <sub>DC</sub> = 500 V	R <sub>IO</sub>	≥ 10 <sup>11</sup>	Ω
Climatic classification (according to IEC 68 part 1)			55/115/21	
Environment (pollution degree in accordance to DIN VDE 0109)			2	
Creepage distance	Standard DIP-4		≥ 7	mm
	SMD		≥ 7	mm
Clearance distance	Standard DIP-4		≥ 8	mm
	SMD		≥ 8	mm
Insulation thickness		DTI	≥ 0.4	mm

**Note**

- As per DIN EN 60747-5-5, § 7.4.3.8.2, this optocoupler is suitable for “safe electrical insulation” only within the safety ratings. Compliance with the safety ratings shall be ensured by means of protective circuits.

**TYPICAL CHARACTERISTICS** ( $T_{amb} = 25\text{ }^{\circ}\text{C}$ , unless otherwise specified)

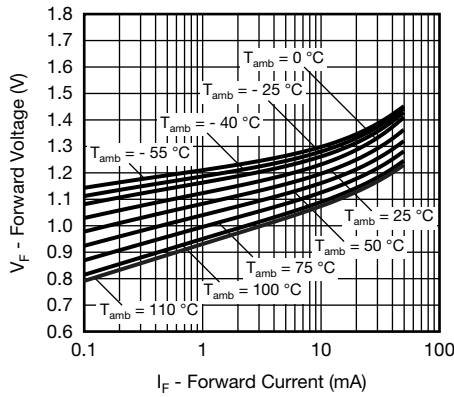

Fig. 5 - Forward Voltage vs. Forward Current



Fig. 8 - Leakage Current vs. Ambient Temperature

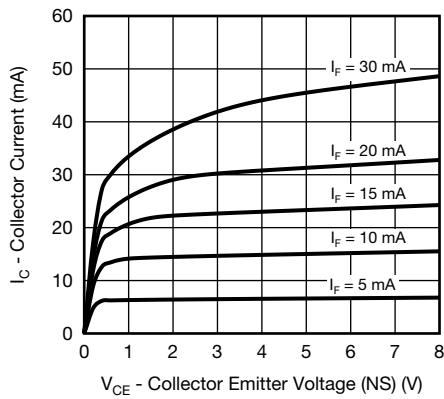

Fig. 6 - Collector Current vs. Collector Emitter Voltage (NS)

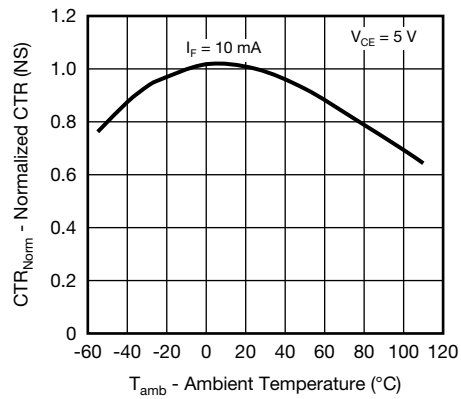

Fig. 9 - Normalized CTR (NS) vs. Ambient Temperature

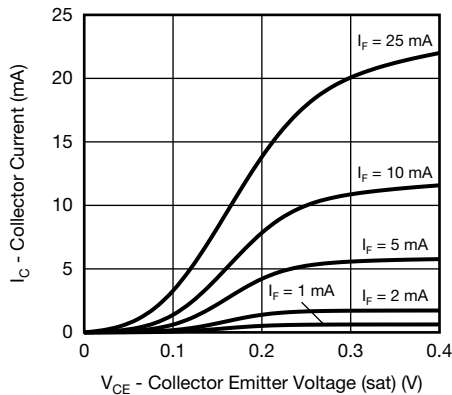

Fig. 7 - Collector Current vs. Collector Emitter Voltage (sat)

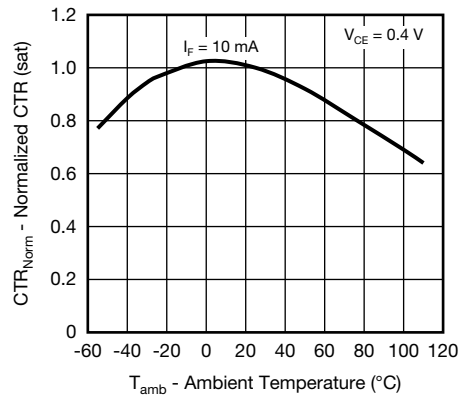

Fig. 10 - Normalized CTR (sat) vs. Ambient Temperature



Fig. 11 - Normalized CTR (NS) vs. Forward Current

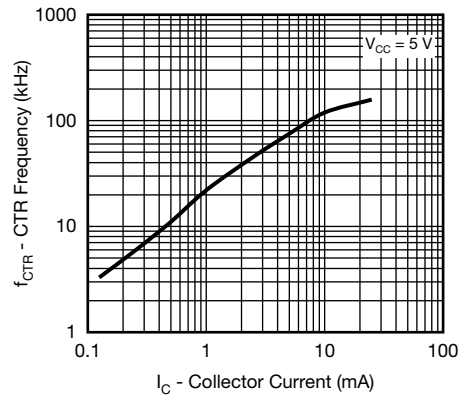

Fig. 14 - CTR -3 dB Frequency vs. Collector Current



Fig. 12 - Normalized CTR (sat) vs. Forward Current



Fig. 15 - Switching Time vs. Load Resistance

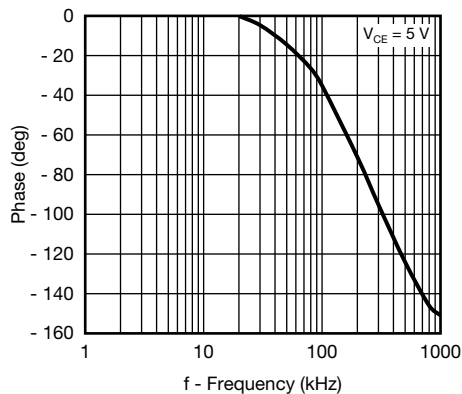

Fig. 13 - CTR Frequency vs. Phase Angle

**PACKAGE DIMENSIONS** in millimeters



22530

**Option 6**



**Option 7**

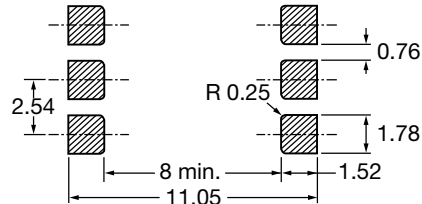

20802-35

**PACKAGE MARKING** (Example of CNY117F-2X017T)



**Notes**

- VDE logo is only marked on option 1 parts. Option information is not marked on the part.
- Tape and reel suffix (T) is not part of the package marking.



TUBE AND TAPE INFORMATION

DEVICES PER TUBE			
TYPE	UNITS/TUBE	TUBES/BOX	UNITS/BOX
DIP-6	50	40	2000



Fig. 16 - Tape and Reel Drawing, 1000 Units per Reel





## **Disclaimer**

ALL PRODUCT, PRODUCT SPECIFICATIONS AND DATA ARE SUBJECT TO CHANGE WITHOUT NOTICE TO IMPROVE RELIABILITY, FUNCTION OR DESIGN OR OTHERWISE.

Vishay Intertechnology, Inc., its affiliates, agents, and employees, and all persons acting on its or their behalf (collectively, "Vishay"), disclaim any and all liability for any errors, inaccuracies or incompleteness contained in any datasheet or in any other disclosure relating to any product.

Vishay makes no warranty, representation or guarantee regarding the suitability of the products for any particular purpose or the continuing production of any product. To the maximum extent permitted by applicable law, Vishay disclaims (i) any and all liability arising out of the application or use of any product, (ii) any and all liability, including without limitation special, consequential or incidental damages, and (iii) any and all implied warranties, including warranties of fitness for particular purpose, non-infringement and merchantability.

Statements regarding the suitability of products for certain types of applications are based on Vishay's knowledge of typical requirements that are often placed on Vishay products in generic applications. Such statements are not binding statements about the suitability of products for a particular application. It is the customer's responsibility to validate that a particular product with the properties described in the product specification is suitable for use in a particular application. Parameters provided in datasheets and / or specifications may vary in different applications and performance may vary over time. All operating parameters, including typical parameters, must be validated for each customer application by the customer's technical experts. Product specifications do not expand or otherwise modify Vishay's terms and conditions of purchase, including but not limited to the warranty expressed therein.

Hyperlinks included in this datasheet may direct users to third-party websites. These links are provided as a convenience and for informational purposes only. Inclusion of these hyperlinks does not constitute an endorsement or an approval by Vishay of any of the products, services or opinions of the corporation, organization or individual associated with the third-party website. Vishay disclaims any and all liability and bears no responsibility for the accuracy, legality or content of the third-party website or for that of subsequent links.

Vishay products are not designed for use in life-saving or life-sustaining applications or any application in which the failure of the Vishay product could result in personal injury or death unless specifically qualified in writing by Vishay. Customers using or selling Vishay products not expressly indicated for use in such applications do so at their own risk. Please contact authorized Vishay personnel to obtain written terms and conditions regarding products designed for such applications.

No license, express or implied, by estoppel or otherwise, to any intellectual property rights is granted by this document or by any conduct of Vishay. Product names and markings noted herein may be trademarks of their respective owners.