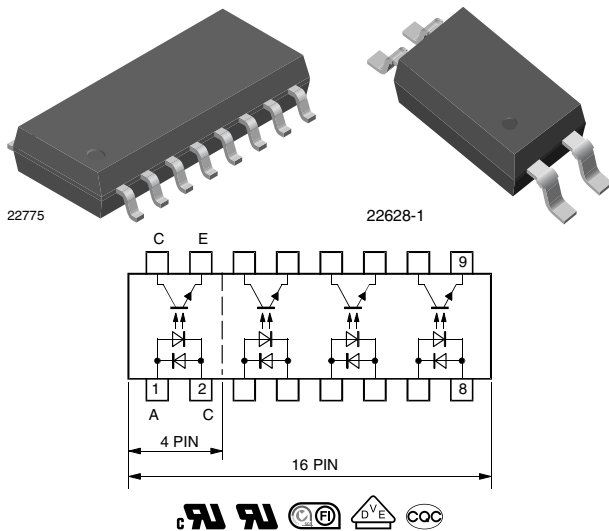


Optocoupler, Phototransistor Output, AC Input, Single / Quad Channel, Half Pitch Mini-Flat Package



FEATURES

- Low profile package (half pitch)
- AC isolation test voltage 3750 V_{RMS}
- Low coupling capacitance of typical 0.3 pF
- Low temperature coefficient of CTR
- Wide ambient temperature range
- Material categorization: for definitions of compliance please see www.vishay.com/doc?99912


RoHS
COMPLIANT

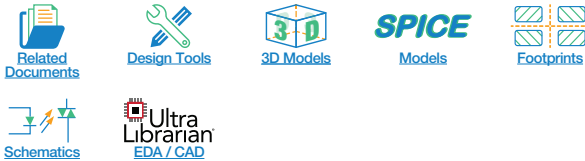
APPLICATIONS

- Programmable logic controllers

AGENCY APPROVALS

- [UL 1577](#)
- [cUL](#)
- [DIN EN 60747-5-5 \(VDA 0884-5\)](#)
- [BSI](#)
- [CQC](#)
- [FIMKO](#)

LINKS TO ADDITIONAL RESOURCES



DESCRIPTION

The low profile miniflat package includes an optocoupler with AC Input and transistor output. It is available in single channel (4 pin) TCMT1600 or quad channel (16 pin) TCMT4600.

ORDERING INFORMATION			
T	C	M	T
#	6	0	#
PART NUMBER			
		SOP-#	
		7 mm	
AGENCY CERTIFIED / PACKAGE	CTR (%)		
	SINGLE CHANNEL	QUAD CHANNEL	
UL, cUL, FIMKO, BSI, CQC, VDE	80 to 300	80 to 300	100 to 300
SOP-4	TCMT1600	-	-
SOP-4	TCMT1600T3 ⁽¹⁾	-	-
SOP-16	-	TCMT4600	TCMT4606
SOP-16	-	TCMT4600T0 ⁽¹⁾	-

Notes

- Available only on tape and reel
- ⁽¹⁾ Product is rotated 180° in tape and reel cavity



ABSOLUTE MAXIMUM RATINGS (T _{amb} = 25 °C, unless otherwise specified)				
PARAMETER	TEST CONDITION	SYMBOL	VALUE	UNIT
INPUT				
Forward current		I _F	± 60	mA
Forward surge current	t _p ≤ 10 μs	I _{FSM}	± 1.5	A
Power dissipation		P _{diss}	100	mW
Junction temperature		T _j	125	°C
OUTPUT				
Collector emitter voltage		V _{CEO}	70	V
Emitter collector voltage		V _{ECO}	7	V
Collector current		I _C	50	mA
Collector peak current	t _p /T = 0.5, t _p ≤ 10 ms	I _{CM}	100	mA
Power dissipation		P _{diss}	150	mW
Junction temperature		T _j	125	°C
COUPLER				
AC isolation test voltage (RMS)		V _{ISO}	3750	V _{RMS}
Total power dissipation		P _{tot}	250	mW
Operating ambient temperature range		T _{amb}	-40 to +100	°C
Storage temperature range		T _{stg}	-40 to +125	°C
Soldering temperature ⁽¹⁾		T _{slid}	260	°C

Notes

- Stresses in excess of the absolute maximum ratings can cause permanent damage to the device. Functional operation of the device is not implied at these or any other conditions in excess of those given in the operational sections of this document. Exposure to absolute maximum ratings for extended periods of the time can adversely affect reliability

⁽¹⁾ Wave soldering three cycles are allowed. Also refer to "Assembly Instructions" (www.vishay.com/doc?80054)

ELECTRICAL CHARACTERISTICS (T _{amb} = 25 °C, unless otherwise specified)						
PARAMETER	TEST CONDITION	SYMBOL	MIN.	TYP.	MAX.	UNIT
INPUT						
Forward voltage	I _F = ± 50 mA	V _F	-	1.35	1.6	V
Junction capacitance	V _R = 0 V, f = 1 MHz	C _j	-	8	-	pF
OUTPUT						
Collector emitter voltage	I _C = 100 μA	V _{CEO}	70	-	-	V
Emitter collector voltage	I _E = 100 μA	V _{ECO}	7	-	-	V
Collector dark current	V _{CE} = 20 V, I _F = 0	I _{CEO}	-	-	100	nA
COUPLER						
Collector emitter saturation voltage	I _F = ± 10 mA, I _C = 1 mA	V _{CEsat}	-	-	0.3	V
Cut-off frequency	V _{CE} = 5 V, I _F = ± 10 mA, R _L = 100 Ω	f _c	-	100	-	kHz
Capacitance (input to output)	f = 1 MHz	C _{IO}	-	0.3	-	pF

Note

- Minimum and maximum values are testing requirements. Typical values are characteristics of the device and are the result of engineering evaluation. Typical values are for information only and are not part of the testing requirements

CURRENT TRANSFER RATIO (T _{amb} = 25 °C, unless otherwise specified)							
PARAMETER	TEST CONDITION	PART	SYMBOL	MIN.	TYP.	MAX.	UNIT
I _C /I _F	V _{CE} = 5 V, I _F = ± 5 mA	TCMT1600	CTR	80	-	300	%
		TCMT4600	CTR	80	-	300	%
		TCMT4606	CTR	100	-	300	%

SWITCHING CHARACTERISTICS ($T_{amb} = 25\text{ }^{\circ}\text{C}$, unless otherwise specified)						
PARAMETER	TEST CONDITION	SYMBOL	MIN.	TYP.	MAX.	UNIT
Delay time	$V_S = 5\text{ V}$, $I_C = 2\text{ mA}$, $R_L = 100\ \Omega$ (see figure 1)	t_d	-	3	-	μs
Rise time	$V_S = 5\text{ V}$, $I_C = 2\text{ mA}$, $R_L = 100\ \Omega$ (see figure 1)	t_r	-	3	-	μs
Fall time	$V_S = 5\text{ V}$, $I_C = 2\text{ mA}$, $R_L = 100\ \Omega$ (see figure 1)	t_f	-	4.7	-	μs
Storage time	$V_S = 5\text{ V}$, $I_C = 2\text{ mA}$, $R_L = 100\ \Omega$ (see figure 1)	t_s	-	0.3	-	μs
Turn-on time	$V_S = 5\text{ V}$, $I_C = 2\text{ mA}$, $R_L = 100\ \Omega$ (see figure 1)	t_{on}	-	6	-	μs
Turn-off time	$V_S = 5\text{ V}$, $I_C = 2\text{ mA}$, $R_L = 100\ \Omega$ (see figure 1)	t_{off}	-	5	-	μs
Turn-on time	$V_S = 5\text{ V}$, $I_F = \pm 10\text{ mA}$, $R_L = 1\text{ k}\Omega$ (see figure 2)	t_{on}	-	9	-	μs
Turn-off time	$V_S = 5\text{ V}$, $I_F = \pm 10\text{ mA}$, $R_L = 1\text{ k}\Omega$ (see figure 2)	t_{off}	-	18	-	μs

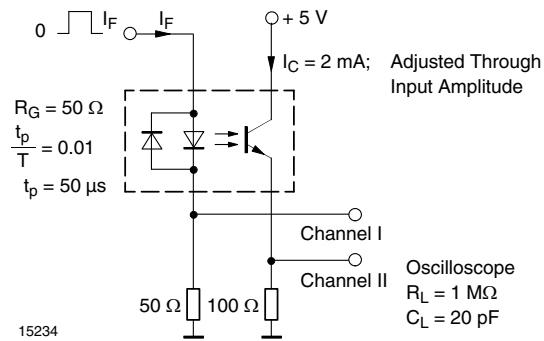


Fig. 1 - Test Circuit, Non-Saturated Operation

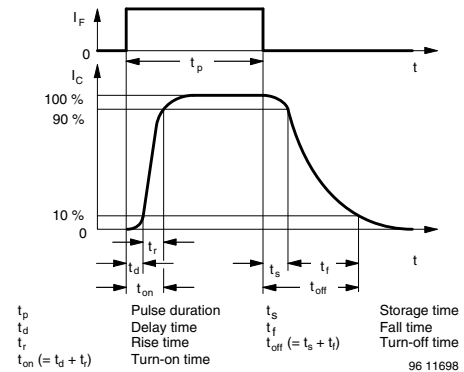


Fig. 3 - Switching Times

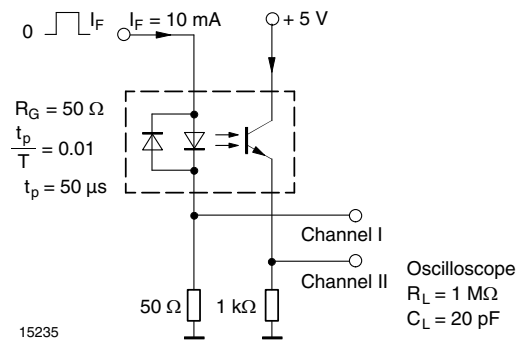


Fig. 2 - Test Circuit, Saturated Operation

SAFETY AND INSULATION RATINGS				
PARAMETER	TEST CONDITION	SYMBOL	VALUE	UNIT
Climatic classification (according to IEC 68 part 1)			55 / 110 / 21	
Comparative tracking index		CTI	175	
Maximum rated withstanding isolation voltage	40 % to 60 % RH, AC test of 1 min	V_{ISO}	3750	V_{RMS}
Maximum transient isolation voltage		V_{IOTM}	6000	V
Maximum repetitive peak isolation voltage		V_{IORM}	707	V
Insulation resistance	$V_{IO} = 500\text{ V}$, $T_{amb} = 100\text{ }^{\circ}\text{C}$	R_{IO}	10^{11}	Ω
Isolation resistance (under fault conditions)	$V_{IO} = 500\text{ V}$, $T_{amb} = T_{SI}$	R_{IO}	10^9	Ω
Output safety power		P_{SO}	350	mW
Input safety current		I_{SI}	200	mA
Input safety temperature		T_{SI}	175	$^{\circ}\text{C}$
Apparent charge test voltage (method A)	$V_{IORM} \times 1.6 = V_{PR}$, type and sample test $t_m = 60\text{ s}$, partial discharge < 5 pC	V_{PR}	1132	V_{peak}
Apparent charge test voltage (method B)	$V_{IORM} \times 1.875 = V_{PR}$, 100 % production test with $t_m = 1\text{ s}$, partial discharge < 5 pC	V_{PR}	1326	V_{peak}
Creepage distance			≥ 5	mm
Clearance distance			≥ 5	mm
Insulation thickness		DTI	≥ 0.4	mm
Environment (pollution degree in accordance to DIN VDE 0109)			2	

Note

- As per IEC 60747-5-5, § 7.4.3.8.2, this optocoupler is suitable for “safe electrical insulation” only within the safety ratings. Compliance with the safety ratings shall be ensured by means of protective circuits

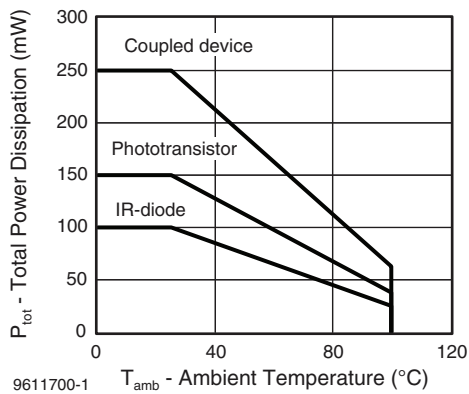
TYPICAL CHARACTERISTICS ($T_{amb} = 25\text{ }^{\circ}\text{C}$, unless otherwise specified)


Fig. 4 - Total Power Dissipation vs. Ambient Temperature

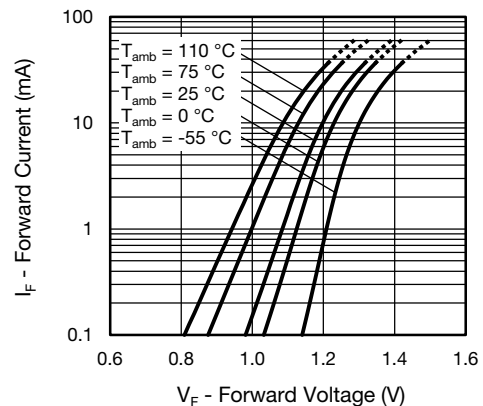


Fig. 5 - Forward Voltage vs. Forward Current

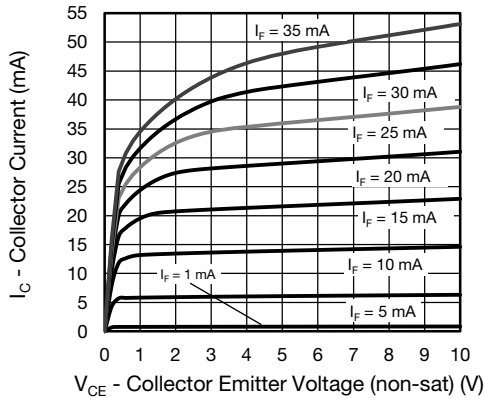


Fig. 6 - Collector Current vs. Collector Emitter Voltage

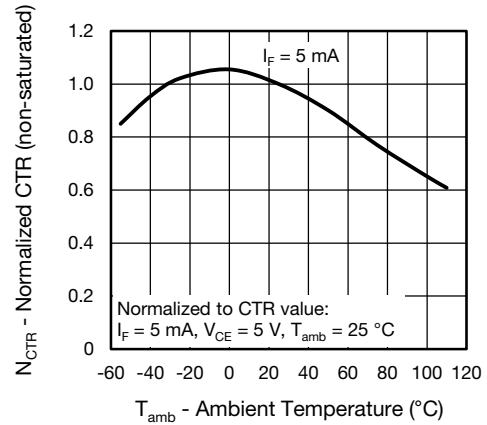


Fig. 9 - Normalized Current Transfer Ratio (non-saturated) vs. Ambient Temperature

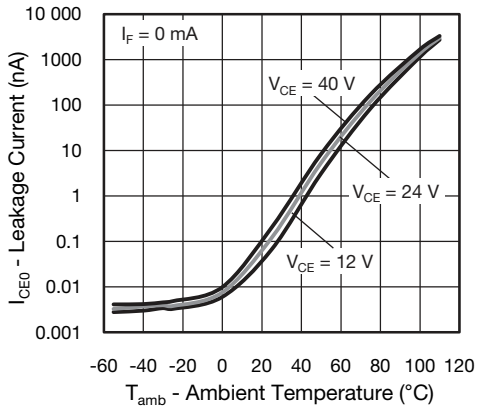


Fig. 7 - Leakage Current vs. Ambient Temperature

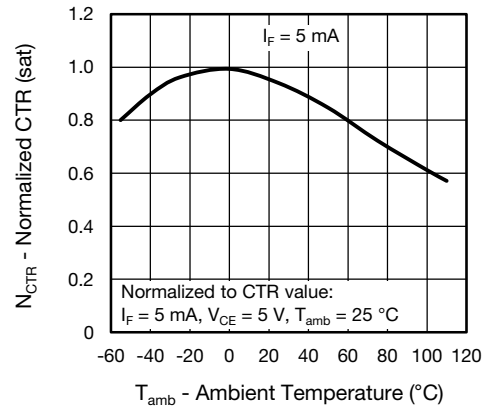


Fig. 10 - Normalized Current Transfer Ratio (saturated) vs. Ambient Temperature

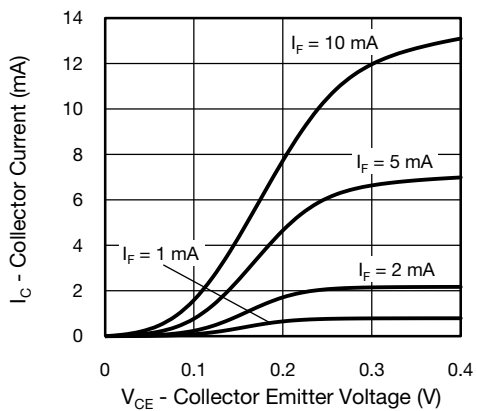


Fig. 8 - Collector Current vs. Collector Emitter Voltage

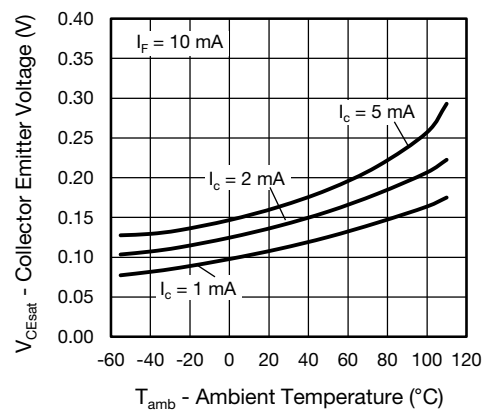


Fig. 11 - Collector Emitter Voltage vs. Ambient Temperature

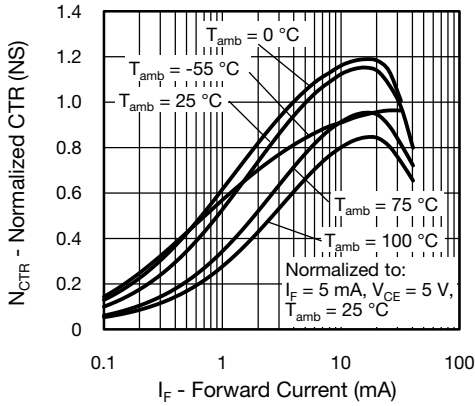


Fig. 12 - Normalized CTR (non-saturated) vs. Forward Current

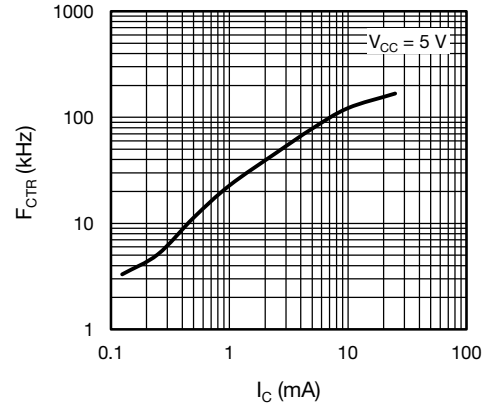


Fig. 15 - F_{CTR} vs. Collector Current

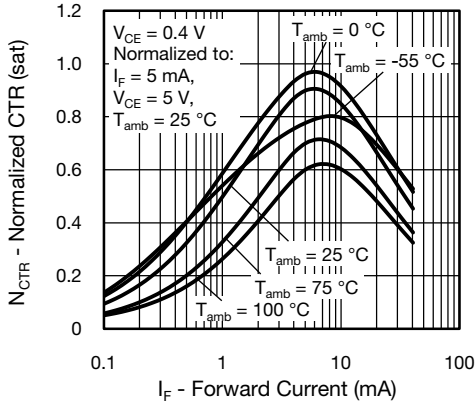


Fig. 13 - Normalized CTR (saturated) vs. Forward Current

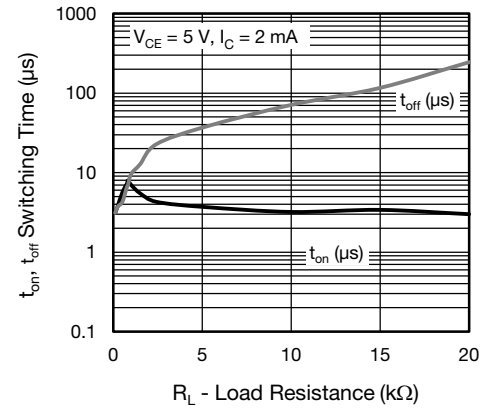


Fig. 16 - Switching Time vs. Load Resistance

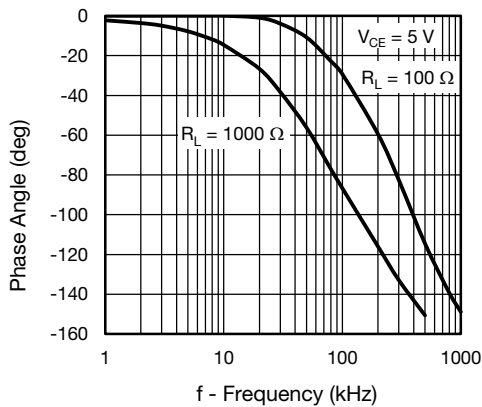
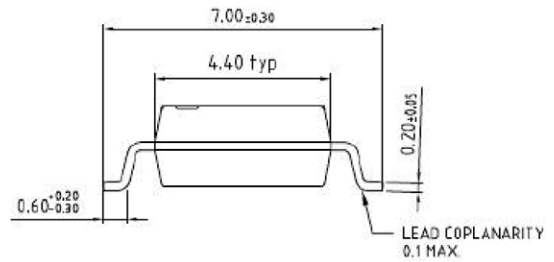
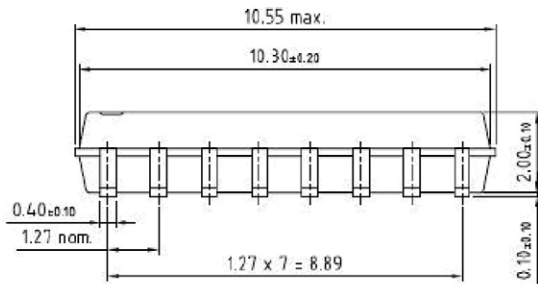
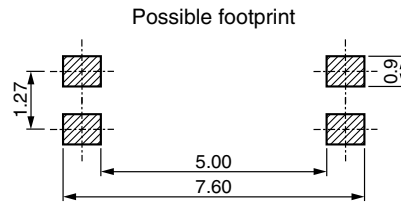
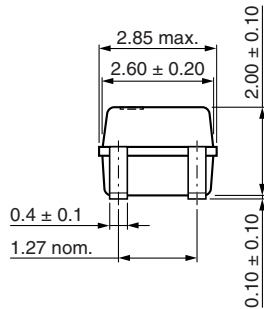
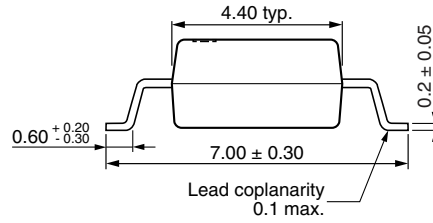
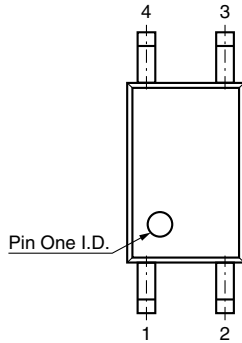


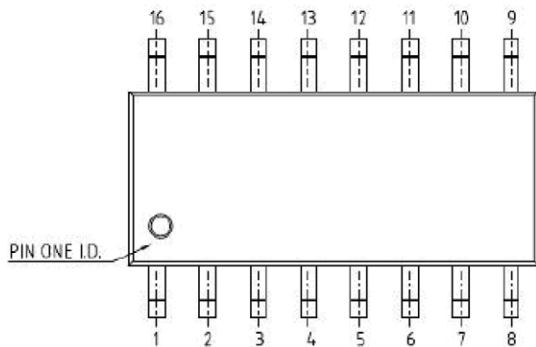
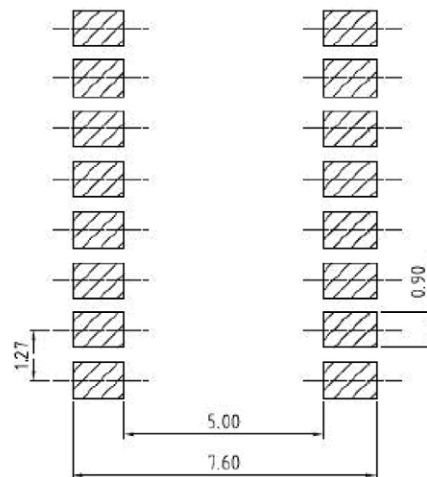
Fig. 14 - F_{CTR} vs. Phase Angle



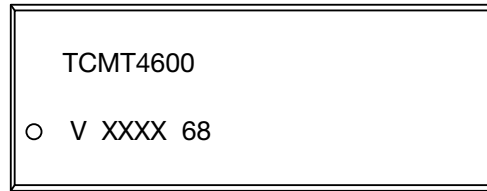
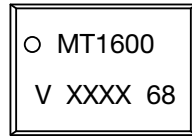
PACKAGE DIMENSIONS in millimeters



Possible footprint



PACKAGE MARKING



Note

- XXXX = LMC (lot marking code)

PACKAGING INFORMATION (TAPE AND REEL) in millimeters

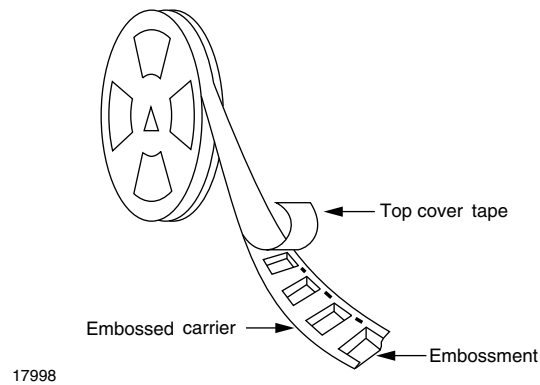


Fig. 17 - Tape and Reel Shipping Medium

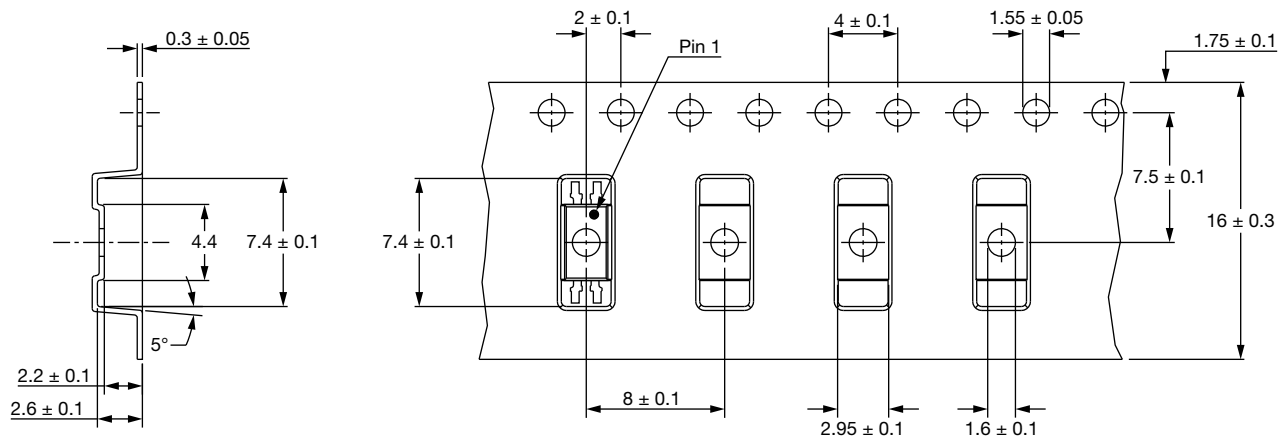


Fig. 18 - Tape and Reel Packing (3000 parts per reel)

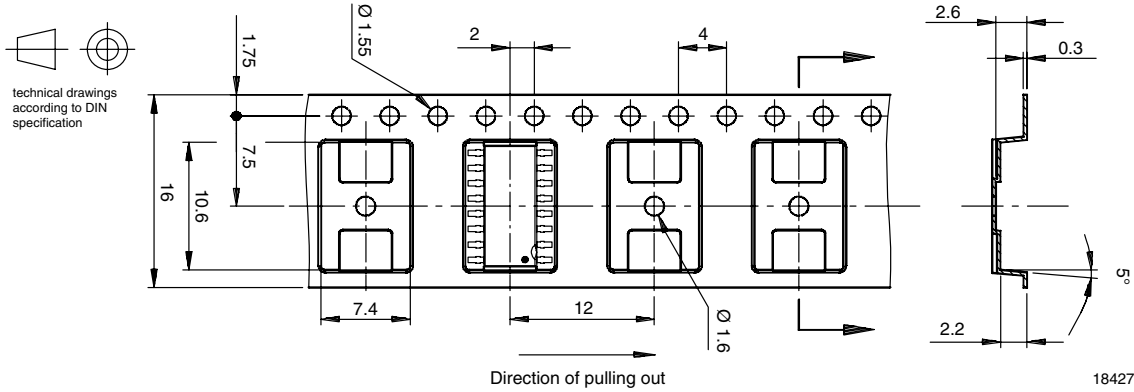


Fig. 19 - TTape and Reel Packing for TCMT460X (2000 parts per reel)

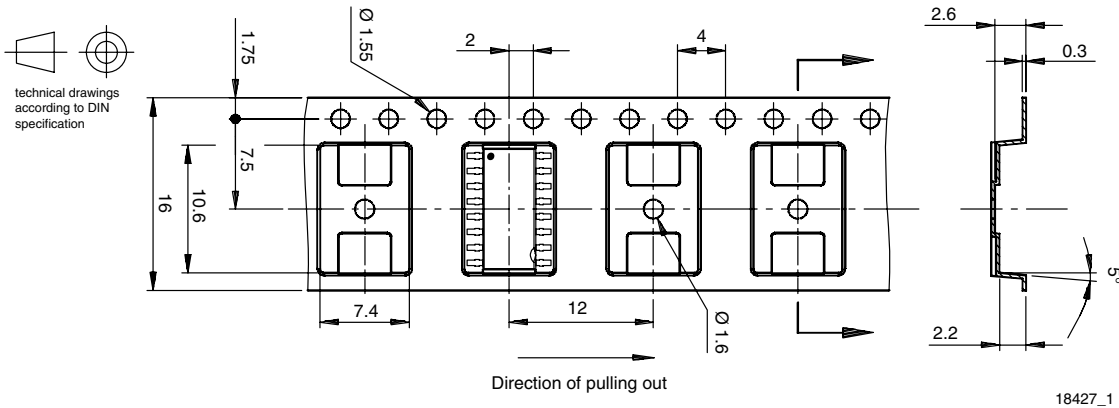
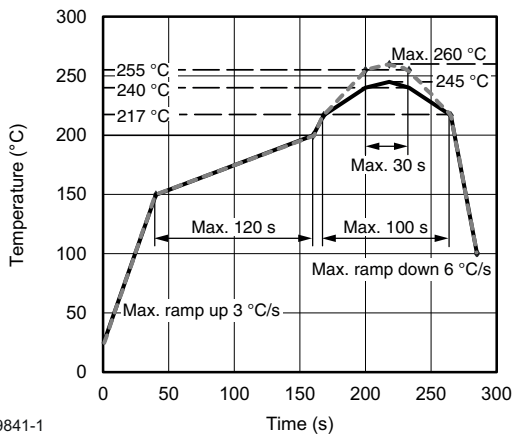


Fig. 20 - TTape and Reel Packing for TCMT460XT0 (2000 parts per reel)

SOLDER PROFILES



19841-1

Fig. 21 - Lead (Pb)-free Reflow Solder Profile According to J-STD-020 for SMD Devices

HANDLING AND STORAGE CONDITIONS

ESD level: HBM class 2

Floor life: unlimited

Conditions: $T_{amb} < 30\text{ °C}$, $RH < 85\%$

Moisture sensitivity level 1, according to J-STD-020



Disclaimer

ALL PRODUCT, PRODUCT SPECIFICATIONS AND DATA ARE SUBJECT TO CHANGE WITHOUT NOTICE TO IMPROVE RELIABILITY, FUNCTION OR DESIGN OR OTHERWISE.

Vishay Intertechnology, Inc., its affiliates, agents, and employees, and all persons acting on its or their behalf (collectively, "Vishay"), disclaim any and all liability for any errors, inaccuracies or incompleteness contained in any datasheet or in any other disclosure relating to any product.

Vishay makes no warranty, representation or guarantee regarding the suitability of the products for any particular purpose or the continuing production of any product. To the maximum extent permitted by applicable law, Vishay disclaims (i) any and all liability arising out of the application or use of any product, (ii) any and all liability, including without limitation special, consequential or incidental damages, and (iii) any and all implied warranties, including warranties of fitness for particular purpose, non-infringement and merchantability.

Statements regarding the suitability of products for certain types of applications are based on Vishay's knowledge of typical requirements that are often placed on Vishay products in generic applications. Such statements are not binding statements about the suitability of products for a particular application. It is the customer's responsibility to validate that a particular product with the properties described in the product specification is suitable for use in a particular application. Parameters provided in datasheets and / or specifications may vary in different applications and performance may vary over time. All operating parameters, including typical parameters, must be validated for each customer application by the customer's technical experts. Product specifications do not expand or otherwise modify Vishay's terms and conditions of purchase, including but not limited to the warranty expressed therein.

Hyperlinks included in this datasheet may direct users to third-party websites. These links are provided as a convenience and for informational purposes only. Inclusion of these hyperlinks does not constitute an endorsement or an approval by Vishay of any of the products, services or opinions of the corporation, organization or individual associated with the third-party website. Vishay disclaims any and all liability and bears no responsibility for the accuracy, legality or content of the third-party website or for that of subsequent links.

Vishay products are not designed for use in life-saving or life-sustaining applications or any application in which the failure of the Vishay product could result in personal injury or death unless specifically qualified in writing by Vishay. Customers using or selling Vishay products not expressly indicated for use in such applications do so at their own risk. Please contact authorized Vishay personnel to obtain written terms and conditions regarding products designed for such applications.

No license, express or implied, by estoppel or otherwise, to any intellectual property rights is granted by this document or by any conduct of Vishay. Product names and markings noted herein may be trademarks of their respective owners.