

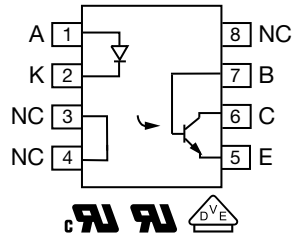

## Optocoupler, Phototransistor Output, With Base Connection in SOIC-8 Package

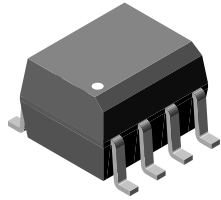

### FEATURES

- High current transfer ratio
- Isolation test voltage, 4000 V<sub>RMS</sub>
- Industry standard SOIC-8 surface mountable package
- Compatible with dual wave, vapor phase and IR reflow soldering
- Material categorization: for definitions of compliance please see [www.vishay.com/doc?99912](http://www.vishay.com/doc?99912)



**RoHS**  
COMPLIANT

### LINKS TO ADDITIONAL RESOURCES



### DESCRIPTION

The IL215AT, IL216AT, IL217AT are optically coupled pairs with a gallium arsenide infrared LED and a silicon NPN phototransistor. Signal information, including a DC level, can be transmitted by the device while maintaining a high degree of electrical isolation between input and output. The IL215AT, IL216AT, IL217AT comes in a standard SOIC-8 small outline package for surface mounting which makes it ideally suited for high density applications with limited space. In addition to eliminating through hole requirements, this package conforms to standards for surface mounted devices.

The high CTR at low input current is designed for low power consumption requirements such as CMOS microprocessor interfaces.

### AGENCY APPROVALS

- [UL](#)
- [cUL](#)
- [DIN EN 60747-5-5 \(VDE 0884-5\)](#), available with option 1

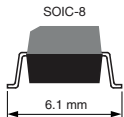
ORDERING INFORMATION			
I	L	2	1
#	A	T	
PART NUMBER			
			
AGENCY CERTIFIED / PACKAGE	CTR (%)		
	1 mA		
UL, cUL	> 20	> 50	> 100
SOIC-8	IL215AT	IL216AT	IL217AT



<b>ABSOLUTE MAXIMUM RATINGS</b> ( $T_{amb} = 25\text{ }^{\circ}\text{C}$ , unless otherwise specified)				
PARAMETER	TEST CONDITION	SYMBOL	VALUE	UNIT
<b>INPUT</b>				
Peak reverse voltage		$V_R$	6	V
Forward continuous current		$I_F$	60	mA
Power dissipation		$P_{diss}$	90	mW
Derate linearly from 25 °C			1.2	mW/°C
<b>OUTPUT</b>				
Collector emitter breakdown voltage		$BV_{CEO}$	30	V
Emitter collector breakdown voltage		$BV_{ECO}$	7	V
Collector base breakdown voltage		$V_{CBO}$	70	V
$I_{C_{MAX, DC}}$		$I_{C_{MAX, DC}}$	50	mA
$I_{C_{MAX}}$	$t < 1\text{ ms}$	$I_{C_{MAX}}$	100	mA
Power dissipation		$P_{diss}$	150	mW
Derate linearly from 25 °C			2	mW/°C
<b>COUPLER</b>				
Isolation test voltage	1 s	$V_{ISO}$	4000	$V_{RMS}$
Total package dissipation	LED and detector	$P_{tot}$	240	mW
Derate linearly from 25 °C			3.2	mW/°C
Storage temperature		$T_{stg}$	-55 to +150	°C
Operating temperature		$T_{amb}$	-55 to +100	°C
Soldering time	At 260 °C		10	s

**Note**

- Stresses in excess of the absolute maximum ratings can cause permanent damage to the device. Functional operation of the device is not implied at these or any other conditions in excess of those given in the operational sections of this document. Exposure to absolute maximum ratings for extended periods of the time can adversely affect reliability.

<b>ELECTRICAL CHARACTERISTICS</b> ( $T_{amb} = 25\text{ }^{\circ}\text{C}$ , unless otherwise specified)						
PARAMETER	TEST CONDITION	SYMBOL	MIN.	TYP.	MAX.	UNIT
<b>INPUT</b>						
Forward voltage	$I_F = 1\text{ mA}$	$V_F$	-	1.0	1.5	V
Reverse current	$V_R = 6\text{ V}$	$I_R$	-	0.1	100	$\mu\text{A}$
Capacitance	$V_R = 0\text{ V}$	$C_O$	-	13	-	pF
<b>OUTPUT</b>						
Collector emitter breakdown voltage	$I_C = 10\text{ }\mu\text{A}$	$BV_{CEO}$	30	-	-	V
Emitter collector breakdown voltage	$I_E = 10\text{ }\mu\text{A}$	$BV_{ECO}$	7	-	-	V
Collector dark current	$V_{CE} = 10\text{ V}, I_F = 0\text{ A}$	$I_{CEO}$	-	5	50	nA
Collector emitter capacitance	$V_{CE} = 0\text{ V}$	$C_{CE}$	-	10	-	pF
<b>COUPLER</b>						
Saturation voltage, collector emitter	$I_F = 1.0\text{ mA}, I_C = 0.1\text{ mA}$	$V_{CEsat}$	-	-	0.4	V
Isolation test voltage	1 s	$V_{ISO}$	4000	-	-	$V_{RMS}$
Capacitance (input to output)		$C_{IO}$	-	0.5	-	pF
Resistance (input to output)		$R_{IO}$	-	100	-	$\text{G}\Omega$

**Note**

- Minimum and maximum values were tested requirements. Typical values are characteristics of the device and are the result of engineering evaluations. Typical values are for information only and are not part of the testing requirements.



CURRENT TRANSFER RATIO							
PARAMETER	TEST CONDITION	PART	SYMBOL	MIN.	TYP.	MAX.	UNIT
DC current transfer ratio	$I_F = 1.0 \text{ mA}$ , $V_{CE} = 5.0 \text{ V}$	IL215AT	$CTR_{DC}$	20	50	-	%
		IL216AT	$CTR_{DC}$	50	80	-	%
		IL217AT	$CTR_{DC}$	100	130	-	%

SWITCHING CHARACTERISTICS							
PARAMETER	TEST CONDITION	SYMBOL	MIN.	TYP.	MAX.	UNIT	
Switching time	$I_F = 2.0 \text{ mA}$ , $R_L = 100 \Omega$ , $V_{CC} = 10 \text{ V}$	$t_{on}$ , $t_{off}$	-	3.0	-	$\mu\text{s}$	

SAFETY AND INSULATION RATINGS							
PARAMETER	TEST CONDITION	SYMBOL	MIN.	TYP.	MAX.	UNIT	
Climatic classification (according to IEC 68 part 1)			-	55 / 100 / 21	-		
Comparative tracking index		CTI	175	-	399		
$V_{IOTM}$			6000	-	-	V	
$V_{IORM}$			560	-	-	V	
$P_{SO}$			-	-	350	mW	
$I_{SI}$			-	-	150	mA	
$T_{SI}$			-	-	165	$^{\circ}\text{C}$	
Creepage distance			4	-	-	mm	
Clearance distance			4	-	-	mm	
Insulation thickness			0.2	-	-	mm	

**Note**

- As per IEC 60747-5-5, §7.4.3.8.1, this optocoupler is suitable for “safe electrical insulation” only within the safety ratings. Compliance with the safety ratings shall be ensured by means of protective circuits.

**TYPICAL CHARACTERISTICS** ( $T_{amb} = 25 \text{ }^{\circ}\text{C}$ , unless otherwise specified)

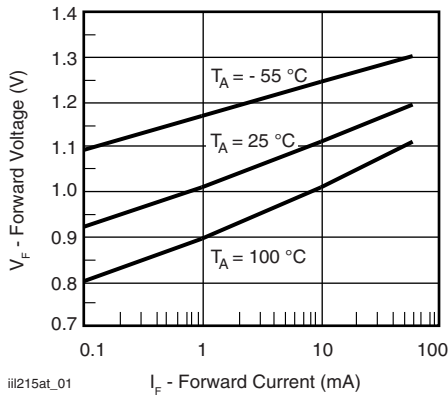

Fig. 1 Forward Voltage vs. Forward Current

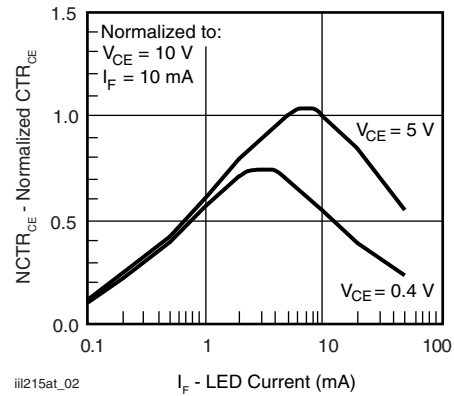

Fig. 2 - Normalized Non-Saturated and Saturated  $CTR_{CE}$  vs. LED Current

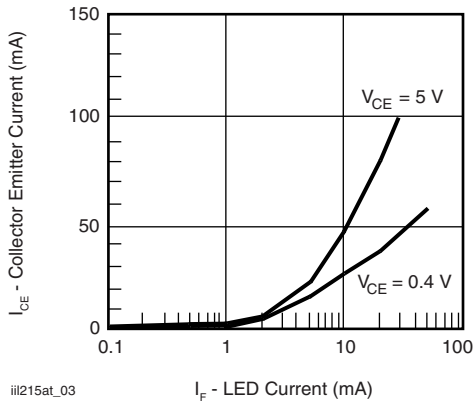

Fig. 3 - Collector Emitter Current vs. LED Current

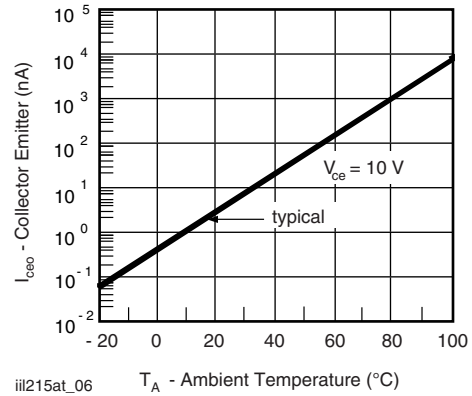

Fig. 6 - Collector Emitter Leakage Current vs. Temperature

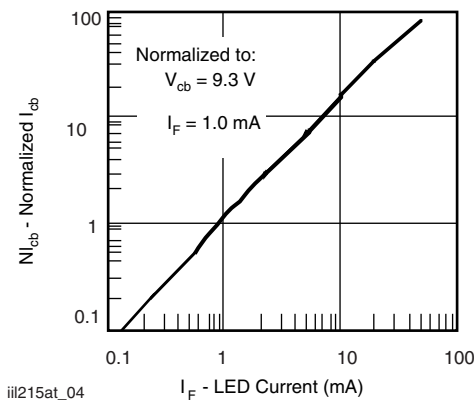

Fig. 4 - Normalized Collector Base Photocurrent vs. LED Current

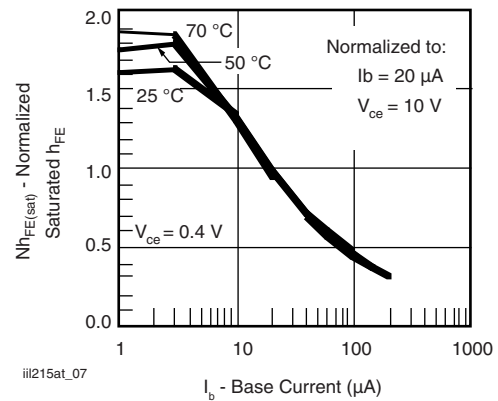

Fig. 7 - Normalized Saturated  $h_{FE}$  vs. Base Current and Temperature

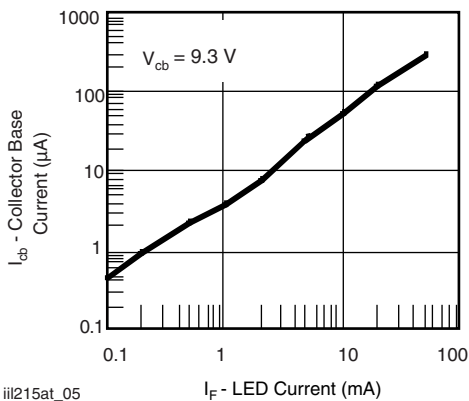

Fig. 5 - Collector Base Photocurrent vs. LED Current

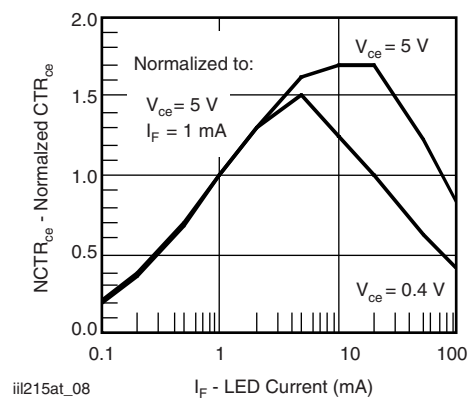
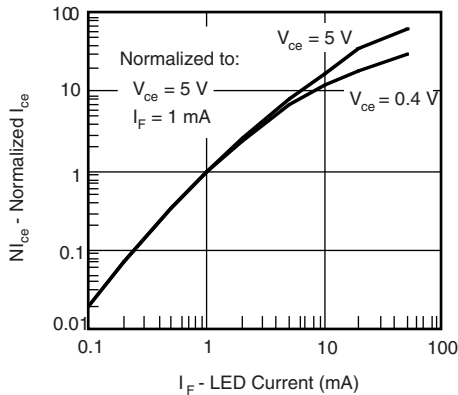
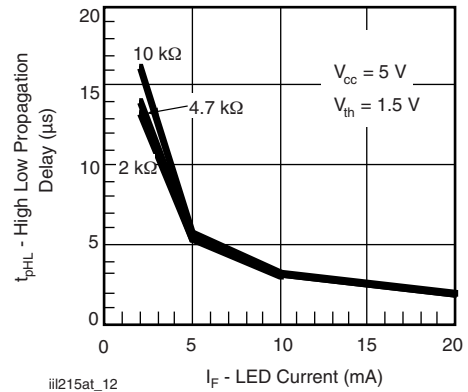

Fig. 8 - Normalized Non-Saturated and Saturated  $CTR_{CE}$  vs. LED Current



ii215at\_09

Fig. 9 - Normalized Non-Saturated and Saturated Collector Emitter Current vs. LED Current



ii215at\_12

Fig. 12 - High to Low Propagation Delay vs. LED Current and Load Resistor

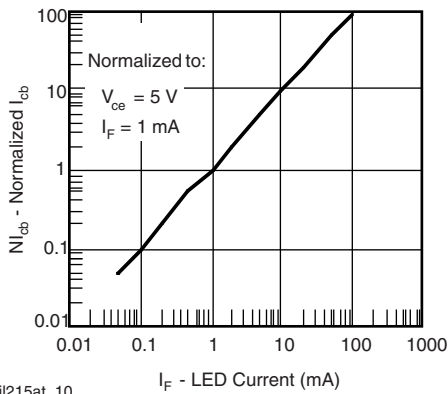

ii215at\_10

Fig. 10 - Normalized Collector Base Photocurrent vs. LED Current

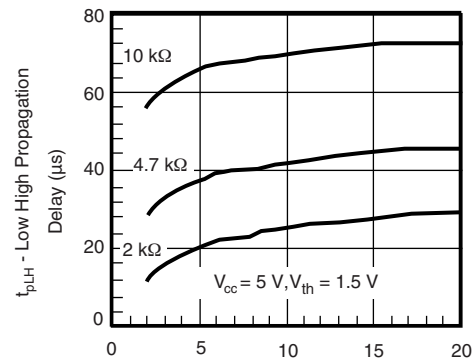

ii215at\_13

Fig. 13 - Low to High Propagation Delay vs. LED Current and Load Resistor

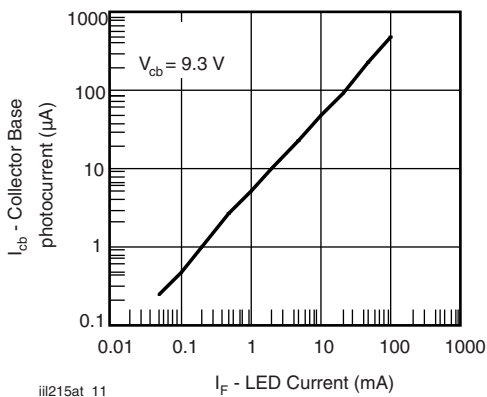

ii215at\_11

Fig. 11 - Collector Base Photocurrent vs. LED Current

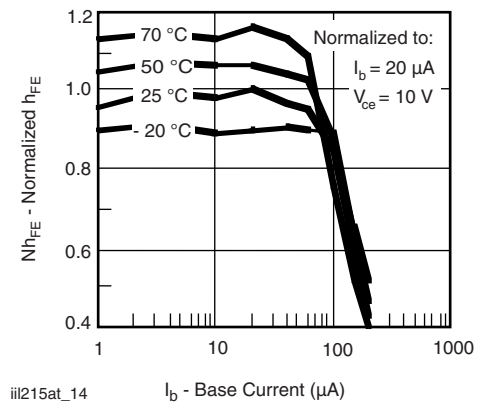

ii215at\_14

Fig. 14 - Normalized Non-Saturated  $h_{FE}$  vs. Base Current and Temperature

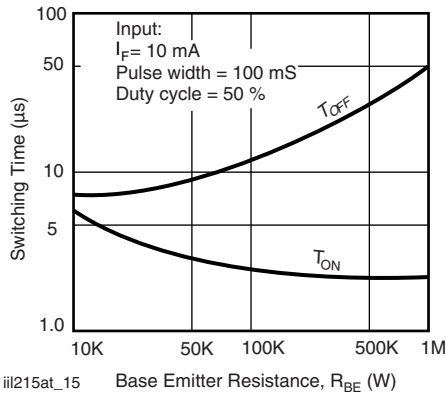

Fig. 15 - Typical Switching Characteristics vs. Base Resistance (Saturated Operation)

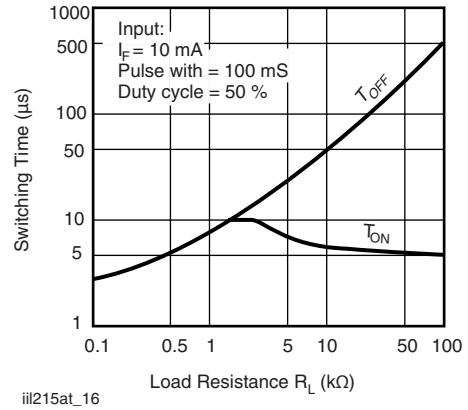
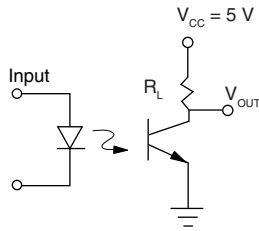

Fig. 16 - Typical Switching Times vs. Load Resistance



ii1215at\_17

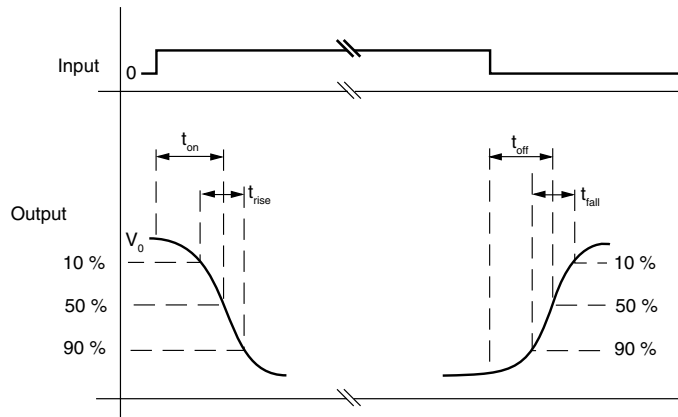
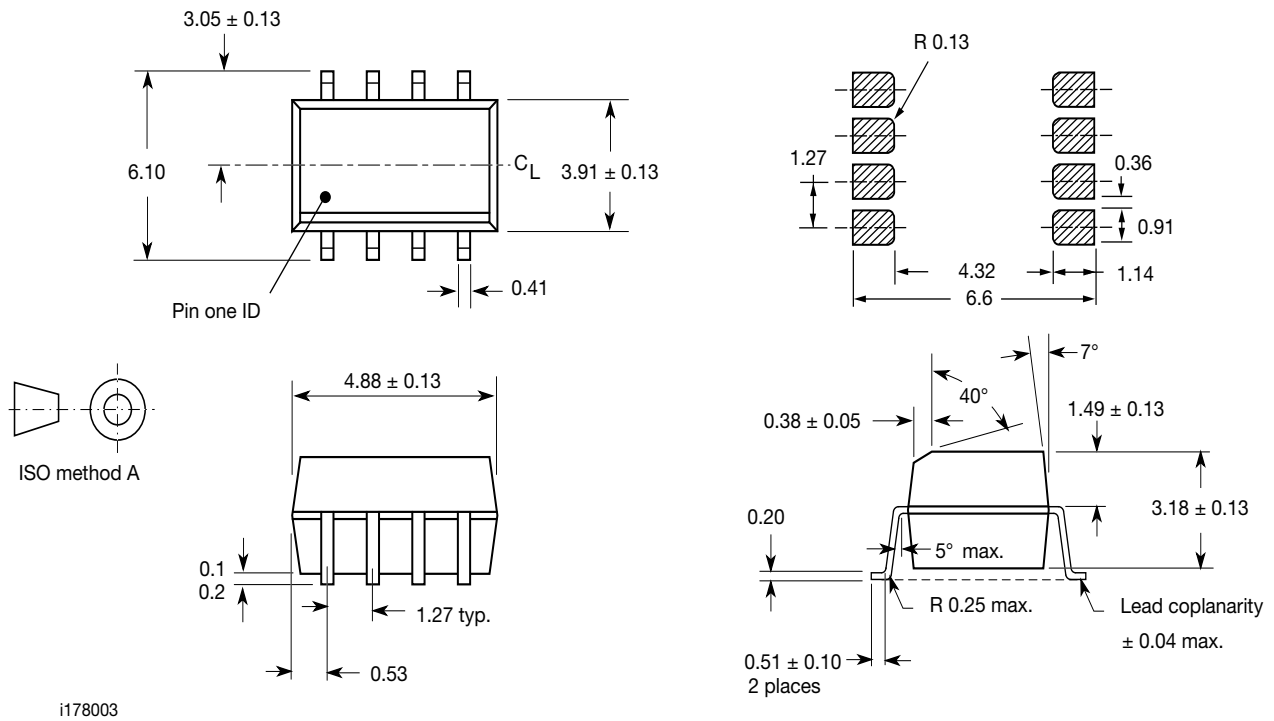

Fig. 17 - Switching Test Circuit

**PACKAGE DIMENSIONS** in millimeters



**PACKAGE MARKING** (example)

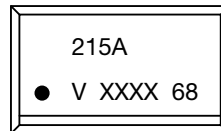

Fig. 18 - Example of IL215AT

**Notes**

- XXXX = LMC (lot marking code)
- Tape and reel suffix (T) is not part of the package marking



## Disclaimer

ALL PRODUCT, PRODUCT SPECIFICATIONS AND DATA ARE SUBJECT TO CHANGE WITHOUT NOTICE TO IMPROVE RELIABILITY, FUNCTION OR DESIGN OR OTHERWISE.

Vishay Intertechnology, Inc., its affiliates, agents, and employees, and all persons acting on its or their behalf (collectively, "Vishay"), disclaim any and all liability for any errors, inaccuracies or incompleteness contained in any datasheet or in any other disclosure relating to any product.

Vishay makes no warranty, representation or guarantee regarding the suitability of the products for any particular purpose or the continuing production of any product. To the maximum extent permitted by applicable law, Vishay disclaims (i) any and all liability arising out of the application or use of any product, (ii) any and all liability, including without limitation special, consequential or incidental damages, and (iii) any and all implied warranties, including warranties of fitness for particular purpose, non-infringement and merchantability.

Statements regarding the suitability of products for certain types of applications are based on Vishay's knowledge of typical requirements that are often placed on Vishay products in generic applications. Such statements are not binding statements about the suitability of products for a particular application. It is the customer's responsibility to validate that a particular product with the properties described in the product specification is suitable for use in a particular application. Parameters provided in datasheets and / or specifications may vary in different applications and performance may vary over time. All operating parameters, including typical parameters, must be validated for each customer application by the customer's technical experts. Product specifications do not expand or otherwise modify Vishay's terms and conditions of purchase, including but not limited to the warranty expressed therein.

Hyperlinks included in this datasheet may direct users to third-party websites. These links are provided as a convenience and for informational purposes only. Inclusion of these hyperlinks does not constitute an endorsement or an approval by Vishay of any of the products, services or opinions of the corporation, organization or individual associated with the third-party website. Vishay disclaims any and all liability and bears no responsibility for the accuracy, legality or content of the third-party website or for that of subsequent links.

Except as expressly indicated in writing, Vishay products are not designed for use in medical, life-saving, or life-sustaining applications or for any other application in which the failure of the Vishay product could result in personal injury or death. Customers using or selling Vishay products not expressly indicated for use in such applications do so at their own risk. Please contact authorized Vishay personnel to obtain written terms and conditions regarding products designed for such applications.

No license, express or implied, by estoppel or otherwise, to any intellectual property rights is granted by this document or by any conduct of Vishay. Product names and markings noted herein may be trademarks of their respective owners.