

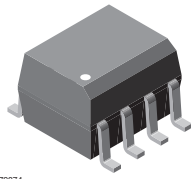

Optocoupler, Phototransistor Output, with Base Connection in SOIC-8 Package

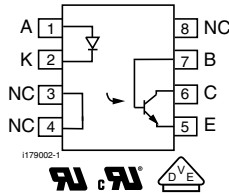

1179074



DESCRIPTION

The VO205AT, VO206AT, VO207AT, VO208AT are optically coupled pairs with a GaAs infrared LED and a silicon NPN phototransistor. Signal information, including a DC level, can be transmitted by the device while maintaining a high degree of electrical isolation between input and output. This family comes in a standard SOIC-8A small outline package for surface mounting which makes them ideally suited for high density application with limited space.

FEATURES

- High BV_{CEO} , 70 V
- Isolation test voltage, 4000 V_{RMS}
- Material categorization: for definitions of compliance please see www.vishay.com/doc?99912



RoHS COMPLIANT

AGENCY APPROVALS

- [UL](#)
- [cUL](#)
- [DIN EN 60747-5-5 \(VDE 0884-5\)](#), available with option 1

ORDERING INFORMATION							
V	O	2	0	#	A	T	
PART NUMBER							
AGENCY CERTIFIED / PACKAGE		CTR (%)					
UL, cUL		40 to 80	63 to 125	100 to 200	160 to 320		
SOIC-8		VO205AT	VO206AT	VO207AT	VO208AT		

ABSOLUTE MAXIMUM RATINGS ($T_{amb} = 25\text{ }^{\circ}\text{C}$, unless otherwise specified)				
PARAMETER	TEST CONDITION	SYMBOL	VALUE	UNIT
INPUT				
Peak reverse voltage		V_R	6	V
Forward continuous current		I_F	60	mA
Peak forward current	1 μs , 300 pps	I_{FM}	1	A
Power dissipation		P_{diss}	90	mW
Derate linearly from 25 $^{\circ}\text{C}$			1.2	mW/ $^{\circ}\text{C}$
OUTPUT				
Collector emitter breakdown voltage		BV_{CEO}	70	V
Emitter collector breakdown voltage		BV_{ECO}	7	V
Collector-base breakdown voltage		BV_{CBO}	70	V
$I_{Cmax, DC}$		$I_{Cmax, DC}$	50	mA
I_{Cmax}	$t < 1\text{ ms}$	I_{Cmax}	100	mA
Power dissipation		P_{diss}	150	mW
Derate linearly from 25 $^{\circ}\text{C}$			2	mW/ $^{\circ}\text{C}$
COUPLER				
Isolation test voltage		V_{ISO}	4000	V_{RMS}
Total package dissipation (LED and detector)		P_{tot}	240	mW
Derate linearly from 25 $^{\circ}\text{C}$			3.3	mW/ $^{\circ}\text{C}$
Operating temperature		T_{amb}	-40 to +100	$^{\circ}\text{C}$
Storage temperature		T_{stg}	-40 to +150	$^{\circ}\text{C}$
Soldering time	at 260 $^{\circ}\text{C}$	T_{sld}	10	s

Note

- Stresses in excess of the absolute maximum ratings can cause permanent damage to the device. Functional operation of the device is not implied at these or any other conditions in excess of those given in the operational sections of this document. Exposure to absolute maximum ratings for extended periods of the time can adversely affect reliability.

ELECTRICAL CHARACTERISTICS ($T_{amb} = 25\text{ }^{\circ}\text{C}$, unless otherwise specified)						
PARAMETER	TEST CONDITION	SYMBOL	MIN.	TYP.	MAX.	UNIT
INPUT						
Forward voltage	$I_F = 10\text{ mA}$	V_F	-	1.3	1.5	V
Reverse current	$V_R = 6\text{ V}$	I_R	-	0.1	100	μA
Capacitance	$V_R = 0\text{ V}$	C_O	-	13	-	pF
OUTPUT						
Collector emitter breakdown voltage	$I_C = 100\text{ }\mu\text{A}$	BV_{CEO}	70	-	-	V
Emitter collector breakdown voltage	$I_E = 10\text{ }\mu\text{A}$	BV_{ECO}	7	10	-	V
Collector base breakdown voltage	$I_C = 100\text{ }\mu\text{A}$	BV_{CBO}	100	-	-	V
Collector base current		I_{CBO}	-	-	1	nA
Emitter base current		I_{EBO}	-	-	1	nA
Collector emitter leakage current	$V_{CE} = 10\text{ V}$	I_{CEO}	-	5	50	nA
Saturation voltage, collector emitter	$I_C = 2\text{ mA}, I_F = 10\text{ mA}$	V_{CEsat}	-	-	0.4	V
COUPLER						
Capacitance, input to output		C_{IO}	-	0.5	-	pF

Note

- Minimum and maximum values were tested requirements. Typical values are characteristics of the device and are the result of engineering evaluations. Typical values are for information only and are not part of the testing requirements.

CURRENT TRANSFER RATIO							
PARAMETER	TEST CONDITION	PART	SYMBOL	MIN.	TYP.	MAX.	UNIT
I_C/I_F	$I_F = 10\text{ mA}, V_{CE} = 5\text{ V}$	VO205AT	CTR	40	-	80	%
		VO206AT	CTR	63	-	125	%
		VO207AT	CTR	100	-	200	%
		VO208AT	CTR	160	-	320	%

SWITCHING CHARACTERISTICS						
PARAMETER	TEST CONDITION	SYMBOL	MIN.	TYP.	MAX.	UNIT
Turn-on time	$I_C = 2\text{ mA}, R_L = 100\text{ }\Omega, V_{CC} = 10\text{ V}$	t_{on}	-	3	-	μs
Turn-off time	$I_C = 2\text{ mA}, R_L = 100\text{ }\Omega, V_{CC} = 10\text{ V}$	t_{off}	-	3	-	μs
Rise time	$I_C = 2\text{ mA}, R_L = 100\text{ }\Omega, V_{CC} = 10\text{ V}$	t_r	-	3	-	μs
Fall time	$I_C = 2\text{ mA}, R_L = 100\text{ }\Omega, V_{CC} = 10\text{ V}$	t_f	-	2	-	μs

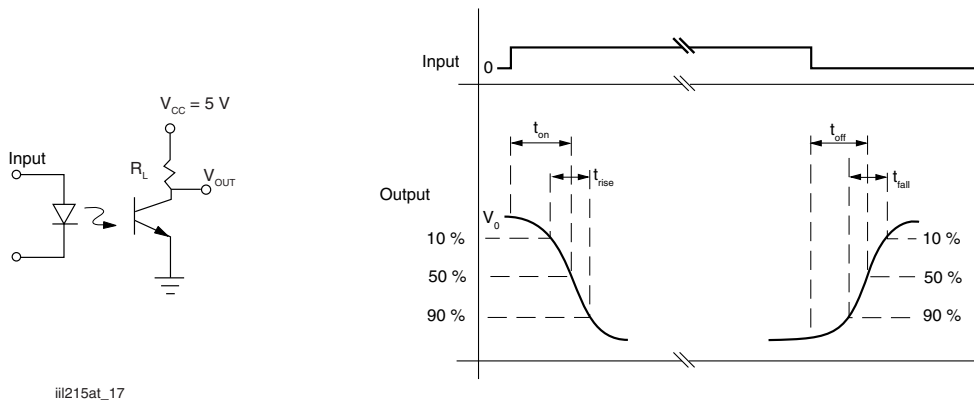

Fig. 1 - Switching Test Circuit

COMMON MODE TRANSIENT IMMUNITY						
PARAMETER	TEST CONDITION	SYMBOL	MIN.	TYP.	MAX.	UNIT
Common mode transient immunity at logic high	$V_{CM} = 1000 V_{P-P}$, $R_L = 1 k\Omega$, $I_F = 0 mA$	$ C_{MH} $	-	5000	-	$V/\mu s$
Common mode transient immunity at logic low	$V_{CM} = 1000 V_{P-P}$, $R_L = 1 k\Omega$, $I_F = 10 mA$	$ C_{ML} $	-	5000	-	$V/\mu s$

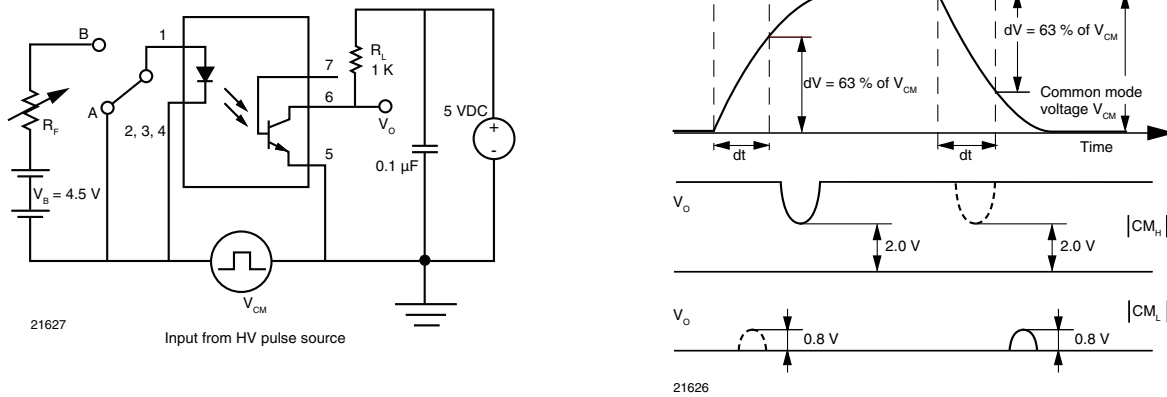

Fig. 2 - Test Circuit for Common Mode Transient Immunity

SAFETY AND INSULATION RATINGS						
PARAMETER	TEST CONDITION	SYMBOL	MIN.	TYP.	MAX.	UNIT
Climatic classification (according to IEC 68 part 1)			-	40 / 100 / 21	-	
Polution degree			-	2	-	
Comparative tracking index		CTI	175	-	399	
Isolation test voltage	1 s	V_{ISO}	4000	-	-	V_{RMS}
Peak transient overvoltage		V_{IOTM}	6000	-	-	V
Peak insulation voltage		V_{IORM}	560	-	-	V
Resistance (input to output)		R_{IO}	-	100	-	$G\Omega$
Safety rating - power output		P_{SO}	-	-	350	mW
Safety rating - input current		I_{SI}	-	-	150	mA
Safety rating - temperature		T_{SI}	-	-	165	$^{\circ}C$
External creepage distance			4	-	-	mm
External clearance distance			4	-	-	mm
Internal creepage distance			3.3	-	-	mm
Insulation thickness			0.2	-	-	mm

Note

- As per IEC 60747-5-2, §7.4.3.8.1, this optocoupler is suitable for “safe electrical insulation” only within the safety ratings. Compliance with the safety ratings shall be ensured by means of protective circuits.

TYPICAL CHARACTERISTICS ($T_{amb} = 25\text{ }^{\circ}\text{C}$, unless otherwise specified)

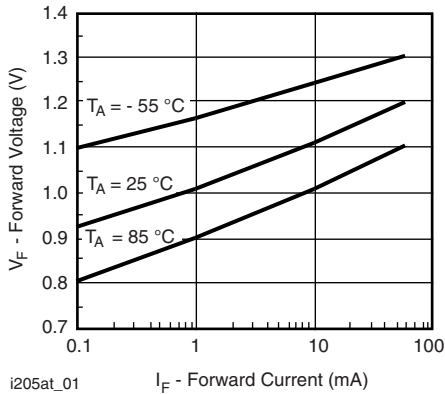

Fig. 3 - Forward Voltage vs. Forward Current

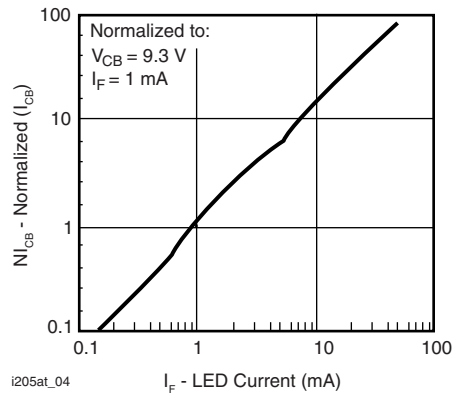

Fig. 6 - Normalized Collector-Base Photocurrent vs. LED Current

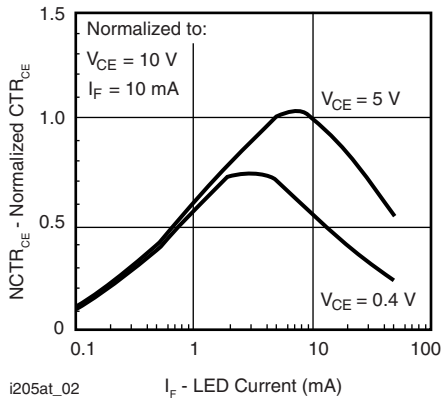

Fig. 4 - Normalized Non-Saturated and Saturated CTR_{CE} vs. LED Current

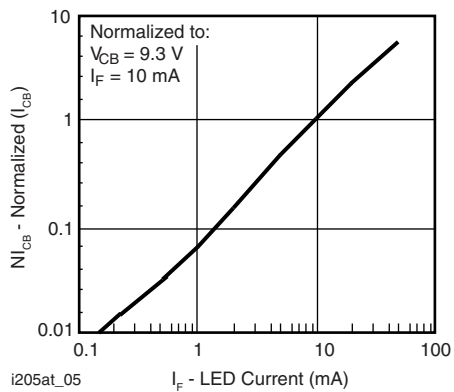

Fig. 7 - Normalized Collector-Base Photocurrent vs. LED Current

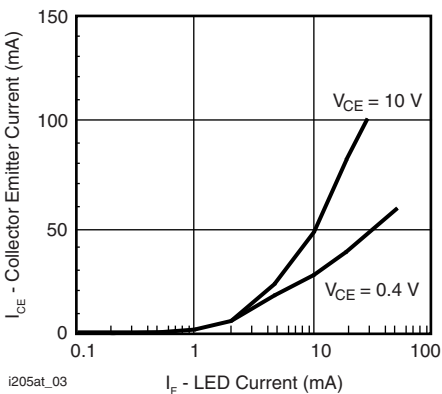

Fig. 5 - Collector Emitter Current vs. LED Current

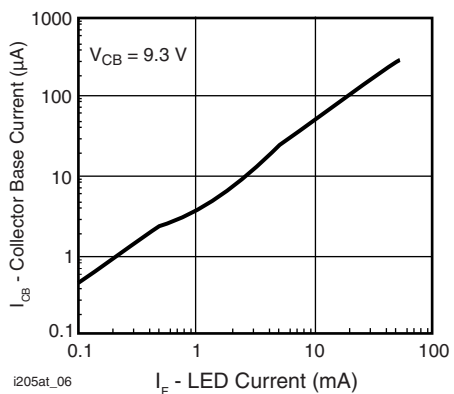
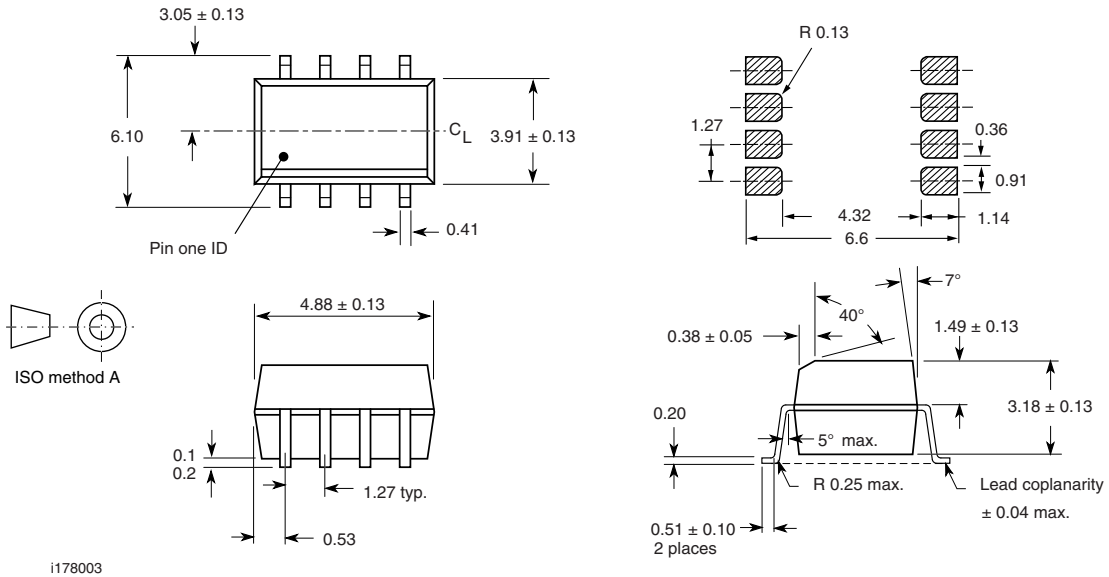
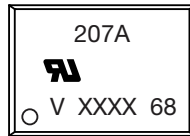

Fig. 8 - Collector Base Photocurrent vs. LED Current

PACKAGE DIMENSIONS in millimeters



PACKAGE MARKING (example of VO207AT)



Note

- XXXX = LMC (lot marking code)

TAPE AND REEL PACKAGING

Dimensions in millimeters

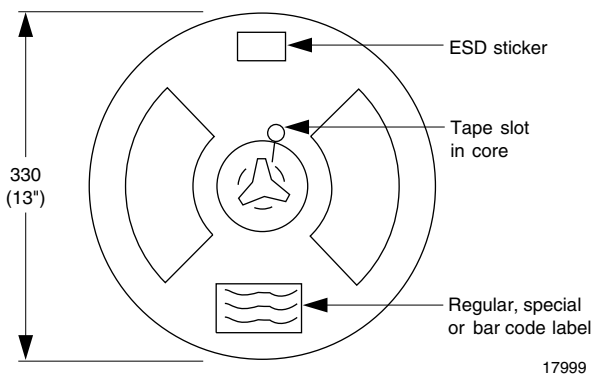

Fig. 9 - Tape and Reel Shipping Medium (EIA-481, revision A, and IEC 60286), 2000 units per reel

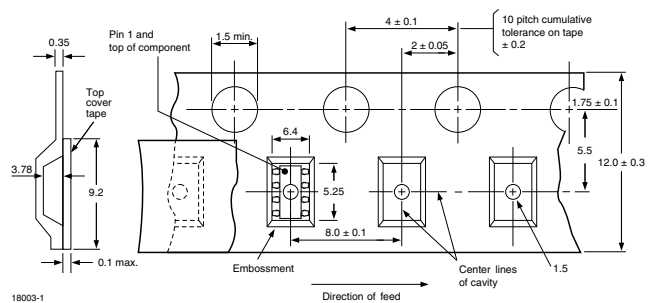

Fig. 10 - Tape Dimensions, 2000 Parts per Reel



Disclaimer

ALL PRODUCT, PRODUCT SPECIFICATIONS AND DATA ARE SUBJECT TO CHANGE WITHOUT NOTICE TO IMPROVE RELIABILITY, FUNCTION OR DESIGN OR OTHERWISE.

Vishay Intertechnology, Inc., its affiliates, agents, and employees, and all persons acting on its or their behalf (collectively, "Vishay"), disclaim any and all liability for any errors, inaccuracies or incompleteness contained in any datasheet or in any other disclosure relating to any product.

Vishay makes no warranty, representation or guarantee regarding the suitability of the products for any particular purpose or the continuing production of any product. To the maximum extent permitted by applicable law, Vishay disclaims (i) any and all liability arising out of the application or use of any product, (ii) any and all liability, including without limitation special, consequential or incidental damages, and (iii) any and all implied warranties, including warranties of fitness for particular purpose, non-infringement and merchantability.

Statements regarding the suitability of products for certain types of applications are based on Vishay's knowledge of typical requirements that are often placed on Vishay products in generic applications. Such statements are not binding statements about the suitability of products for a particular application. It is the customer's responsibility to validate that a particular product with the properties described in the product specification is suitable for use in a particular application. Parameters provided in datasheets and / or specifications may vary in different applications and performance may vary over time. All operating parameters, including typical parameters, must be validated for each customer application by the customer's technical experts. Product specifications do not expand or otherwise modify Vishay's terms and conditions of purchase, including but not limited to the warranty expressed therein.

Hyperlinks included in this datasheet may direct users to third-party websites. These links are provided as a convenience and for informational purposes only. Inclusion of these hyperlinks does not constitute an endorsement or an approval by Vishay of any of the products, services or opinions of the corporation, organization or individual associated with the third-party website. Vishay disclaims any and all liability and bears no responsibility for the accuracy, legality or content of the third-party website or for that of subsequent links.

Vishay products are not designed for use in life-saving or life-sustaining applications or any application in which the failure of the Vishay product could result in personal injury or death unless specifically qualified in writing by Vishay. Customers using or selling Vishay products not expressly indicated for use in such applications do so at their own risk. Please contact authorized Vishay personnel to obtain written terms and conditions regarding products designed for such applications.

No license, express or implied, by estoppel or otherwise, to any intellectual property rights is granted by this document or by any conduct of Vishay. Product names and markings noted herein may be trademarks of their respective owners.