

FEATURES

- ▶ Qualified for automotive applications
- ▶ Low power operation
 - ▶ 5 V operation
 - ▶ 1.2 mA per channel maximum at 0 Mbps to 2 Mbps
 - ▶ 3.5 mA per channel maximum at 10 Mbps
 - ▶ 32 mA per channel maximum at 90 Mbps
 - ▶ 3 V operation
 - ▶ 0.8 mA per channel maximum at 0 Mbps to 2 Mbps
 - ▶ 2.2 mA per channel maximum at 10 Mbps
 - ▶ 20 mA per channel maximum at 90 Mbps
- ▶ Bidirectional communication
- ▶ 3 V/5 V level translation
- ▶ High temperature operation: 125°C
- ▶ High data rate: dc to 90 Mbps (NRZ)
- ▶ Precise timing characteristics
 - ▶ 2 ns maximum pulse width distortion
 - ▶ 2 ns maximum channel-to-channel matching
- ▶ High common-mode transient immunity: >25 kV/μs
- ▶ Output enable function
- ▶ [16-lead SOIC wide body package](#)
- ▶ RoHS-compliant models available
- ▶ [Safety and regulatory approvals](#)
 - ▶ UL 1577:
 - ▶ $V_{ISO} = 2500 V_{rms}$ for 1 minute
 - ▶ IEC/EN/CSA 62368-1
 - ▶ EN 60950-1
 - ▶ IEC/CSA 60601-1
 - ▶ IEC/CSA 61010-1
 - ▶ CQC GB4943.1
 - ▶ DIN EN IEC 60747-17 (VDE 0884-17)
 - ▶ $V_{IORM} = 560 V_{peak}$

APPLICATIONS

- ▶ General-purpose multichannel isolation
- ▶ SPI interface/data converter isolation
- ▶ RS-232/RS-422/RS-485 transceivers
- ▶ Industrial field bus isolation
- ▶ Automotive systems

GENERAL DESCRIPTION

The ADuM1300/ADuM1301¹ are triple-channel digital isolators based on the Analog Devices, Inc., *iCoupler*® technology. Combining high speed CMOS and monolithic transformer technology, these isolation components provide outstanding performance characteristics superior to alternatives, such as optocouplers.

By avoiding the use of LEDs and photodiodes, *iCoupler* devices remove the design difficulties commonly associated with optocouplers. The typical optocoupler concerns regarding uncertain current transfer ratios, nonlinear transfer functions, and temperature and lifetime effects are eliminated with the simple *iCoupler* digital interfaces and stable performance characteristics. The need for external drivers and other discrete components is eliminated with these *iCoupler* products. Furthermore, *iCoupler* devices consume one-tenth to one-sixth of the power of optocouplers at comparable signal data rates.

The ADuM1300/ADuM1301 isolators provide three independent isolation channels in a variety of channel configurations and data rates (see the [Ordering Guide](#)). Both models operate with the supply voltage on either side ranging from 2.7 V to 5.5 V, providing compatibility with lower voltage systems as well as enabling a voltage translation functionality across the isolation barrier. In addition, the ADuM1300/ADuM1301 provide low pulse width distortion (<2 ns for CRW grade) and tight channel-to-channel matching (<2 ns for CRW grade). Unlike other optocoupler alternatives, the ADuM1300/ADuM1301 isolators have a patented refresh feature that ensures dc correctness in the absence of input logic transitions and when power is not applied to one of the supplies.

¹ Protected by U.S. Patents 5,952,849; 6,873,065; 6,903,578; and 7,075,329.

TABLE OF CONTENTS

| | | | |
|--|----|---|----|
| Features..... | 1 | DIN EN IEC 60747-17 (VDE 0884-17) | |
| Applications..... | 1 | Insulation Characteristics..... | 21 |
| General Description..... | 1 | Recommended Operating Conditions..... | 22 |
| Functional Block Diagrams..... | 4 | Absolute Maximum Ratings..... | 23 |
| Specifications..... | 5 | ESD Caution..... | 23 |
| Electrical Characteristics—5 V, 105°C | | Pin Configurations and Function Descriptions..... | 24 |
| Operation..... | 5 | Typical Performance Characteristics..... | 26 |
| Electrical Characteristics—3 V, 105°C | | Truth Table..... | 28 |
| Operation..... | 7 | Applications Information..... | 29 |
| Electrical Characteristics—Mixed 5 V/3 V or | | Printed Circuit Board (PCB) Layout..... | 29 |
| 3 V/5 V, 105°C Operation..... | 9 | Propagation Delay-Related Parameters..... | 29 |
| Electrical Characteristics—5 V, 125°C | | DC Correctness and Magnetic Field | |
| Operation..... | 12 | Immunity..... | 29 |
| Electrical Characteristics—3 V, 125°C | | Power Consumption..... | 30 |
| Operation..... | 14 | Insulation Lifetime..... | 30 |
| Electrical Characteristics—Mixed 5 V/3 V, | | Outline Dimensions..... | 31 |
| 125°C Operation..... | 16 | Ordering Guide..... | 31 |
| Electrical Characteristics—Mixed 3 V/5 V, | | Number of Inputs, Maximum Data Rate, | |
| 125°C Operation..... | 18 | Maximum Propagation Delay and | |
| Package Characteristics..... | 20 | Maximum Pulse Width Distortion..... | 31 |
| Regulatory Information..... | 20 | Evaluation Boards..... | 32 |
| Insulation and Safety-Related Specifications... 20 | | Automotive Products..... | 33 |

REVISION HISTORY

9/2024—Rev. L to Rev. M

| | |
|---|----|
| Changes to Features Section..... | 1 |
| Changes to Regulatory Information Section and Table 9..... | 20 |
| Changes to Table 10..... | 20 |
| Changed DIN V VDE V 0884-10 (VDE V 0884-10):2006-12 Insulation Characteristics Section to DIN EN IEC 60747-17 (VDE 0884-17) Insulation Characteristics Section..... | 21 |
| Changes to DIN EN IEC 60747-17 (VDE 0884-17) Insulation Characteristics Section and Table 11..... | 21 |
| Changes to Figure 3 Caption..... | 21 |
| Deleted Table 14; Renumbered Sequentially..... | 23 |
| Changed Changed Maximum Continuous Working Voltage and Truth Table Section to Truth Table Section..... | 28 |
| Moved Truth Table Section and Table 16..... | 28 |
| Changes to Insulation Lifetime Section..... | 30 |
| Deleted Figure 18 to Figure 20..... | 30 |

5/2023—Rev. K to Rev. L

| | |
|--|----|
| Moved Figure 1 and Figure 2..... | 4 |
| Changes to Logic High Output Voltages Parameter and Logic Low Output Voltages Parameter, Table 1..... | 5 |
| Changes to Logic High Output Voltages Parameter and Logic Low Output Voltages Parameter, Table 2..... | 7 |
| Changes to Logic High Output Voltages Parameter and Logic Low Output Voltages Parameter, Table 3..... | 9 |
| Changes to Logic High Output Voltages Parameter and Logic Low Output Voltages Parameter, Table 4.... | 12 |
| Changes to Logic High Output Voltages Parameter and Logic Low Output Voltages Parameter, Table 5.... | 14 |
| Changes to Logic High Output Voltages Parameter, Logic Low Output Voltages Parameter, and Note 1 to Note 8, Table 6..... | 16 |

TABLE OF CONTENTS

Changes to Logic High Output Voltages Parameter and Logic Low Output Voltages Parameter, Table 7.... 18

FUNCTIONAL BLOCK DIAGRAMS

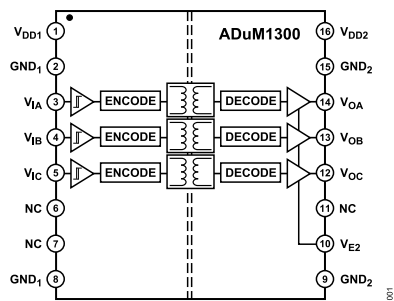

Figure 1. ADuM1300 Functional Block Diagram

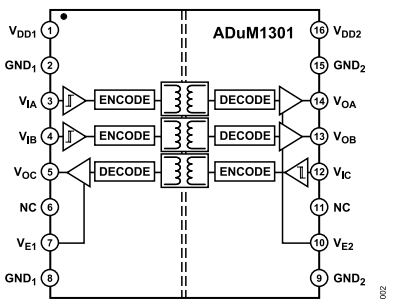

Figure 2. ADuM1301 Functional Block Diagram

SPECIFICATIONS

ELECTRICAL CHARACTERISTICS—5 V, 105°C OPERATION

All voltages are relative to their respective ground. $4.5\text{ V} \leq V_{DD1} \leq 5.5\text{ V}$, $4.5\text{ V} \leq V_{DD2} \leq 5.5\text{ V}$; all minimum/maximum specifications apply over the entire recommended operation range, unless otherwise noted; all typical specifications are at $T_A = 25^\circ\text{C}$, $V_{DD1} = V_{DD2} = 5\text{ V}$. These specifications do not apply to ADuM1300W and ADuM1301W automotive grade versions.

Table 1.

| Parameter | Symbol | Min | Typ | Max | Unit | Test Conditions/Comments |
|--|--|--------------------------------|-------|------|---------------|--|
| DC SPECIFICATIONS | | | | | | |
| Input Supply Current per Channel, Quiescent | $I_{DD1(Q)}$ | | 0.50 | 0.53 | mA | |
| Output Supply Current per Channel, Quiescent | $I_{DD0(Q)}$ | | 0.19 | 0.24 | mA | |
| ADuM1300 Total Supply Current, Three Channels ¹ | | | | | | |
| DC to 2 Mbps | | | | | | |
| V_{DD1} Supply Current | $I_{DD1(Q)}$ | | 1.6 | 2.5 | mA | DC to 1 MHz logic signal freq. |
| V_{DD2} Supply Current | $I_{DD2(Q)}$ | | 0.7 | 1.0 | mA | DC to 1 MHz logic signal freq. |
| 10 Mbps (BRW and CRW Grades Only) | | | | | | |
| V_{DD1} Supply Current | $I_{DD1(10)}$ | | 6.5 | 8.1 | mA | 5 MHz logic signal freq. |
| V_{DD2} Supply Current | $I_{DD2(10)}$ | | 1.9 | 2.5 | mA | 5 MHz logic signal freq. |
| 90 Mbps (CRW Grade Only) | | | | | | |
| V_{DD1} Supply Current | $I_{DD1(90)}$ | | 57 | 77 | mA | 45 MHz logic signal freq. |
| V_{DD2} Supply Current | $I_{DD2(90)}$ | | 16 | 18 | mA | 45 MHz logic signal freq. |
| ADuM1301 Total Supply Current, Three Channels ¹ | | | | | | |
| DC to 2 Mbps | | | | | | |
| V_{DD1} Supply Current | $I_{DD1(Q)}$ | | 1.3 | 2.1 | mA | DC to 1 MHz logic signal freq. |
| V_{DD2} Supply Current | $I_{DD2(Q)}$ | | 1.0 | 1.4 | mA | DC to 1 MHz logic signal freq. |
| 10 Mbps (BRW and CRW Grades Only) | | | | | | |
| V_{DD1} Supply Current | $I_{DD1(10)}$ | | 5.0 | 6.2 | mA | 5 MHz logic signal freq. |
| V_{DD2} Supply Current | $I_{DD2(10)}$ | | 3.4 | 4.2 | mA | 5 MHz logic signal freq. |
| 90 Mbps (CRW Grade Only) | | | | | | |
| V_{DD1} Supply Current | $I_{DD1(90)}$ | | 43 | 57 | mA | 45 MHz logic signal freq. |
| V_{DD2} Supply Current | $I_{DD2(90)}$ | | 29 | 37 | mA | 45 MHz logic signal freq. |
| For All Models | | | | | | |
| Input Currents | $I_{IA}, I_{IB}, I_{IC}, I_{E1}, I_{E2}$ | -10 | +0.01 | +10 | μA | $0\text{ V} \leq V_{IA}, V_{IB}, V_{IC} \leq V_{DD1}$ or V_{DD2} , $0\text{ V} \leq V_{E1}, V_{E2} \leq V_{DD1}$ or V_{DD2} |
| Logic High Input Threshold | V_{IH}, V_{EH} | 2.0 | | | V | |
| Logic Low Input Threshold | V_{IL}, V_{EL} | | | 0.8 | V | |
| Logic High Output Voltages | $V_{OAH}, V_{OBH}, V_{OCH}$ | $(V_{DD1}$ or $V_{DD2}) - 0.1$ | 5.0 | | V | $I_{OX} = -20\ \mu\text{A}$, $V_{IX} = V_{IXH}$ |
| | | $(V_{DD1}$ or $V_{DD2}) - 0.4$ | 4.8 | | V | $I_{OX} = -3.2\ \text{mA}$, $V_{IX} = V_{IXH}$ |
| Logic Low Output Voltages | $V_{OAL}, V_{OBL}, V_{OCL}$ | | 0.0 | 0.1 | V | $I_{OX} = 20\ \mu\text{A}$, $V_{IX} = V_{IXL}$ |
| | | | 0.04 | 0.1 | V | $I_{OX} = 400\ \mu\text{A}$, $V_{IX} = V_{IXL}$ |
| | | | 0.2 | 0.4 | V | $I_{OX} = 3.2\ \text{mA}$, $V_{IX} = V_{IXL}$ |
| SWITCHING SPECIFICATIONS | | | | | | |
| ADuM1300ARW/ADuM1301ARW | | | | | | |
| Minimum Pulse Width ² | PW | | | 1000 | ns | $C_L = 15\ \text{pF}$, CMOS signal levels |
| Maximum Data Rate ³ | | 1 | | | Mbps | $C_L = 15\ \text{pF}$, CMOS signal levels |
| Propagation Delay ⁴ | t_{PHL}, t_{PLH} | 50 | 65 | 100 | ns | $C_L = 15\ \text{pF}$, CMOS signal levels |
| Pulse Width Distortion, $ t_{PLH} - t_{PHL} $ ⁴ | PWD | | | 40 | ns | $C_L = 15\ \text{pF}$, CMOS signal levels |
| Change vs. Temperature | | | 11 | | ps/°C | $C_L = 15\ \text{pF}$, CMOS signal levels |
| Propagation Delay Skew ⁵ | t_{PSK} | | | 50 | ns | $C_L = 15\ \text{pF}$, CMOS signal levels |
| Channel-to-Channel Matching ⁶ | t_{PSKCD}/t_{PSKOD} | | | 50 | ns | $C_L = 15\ \text{pF}$, CMOS signal levels |

SPECIFICATIONS

Table 1. (Continued)

| Parameter | Symbol | Min | Typ | Max | Unit | Test Conditions/Comments |
|---|-----------------------|-----|------|------|-------------|--|
| ADuM1300BRW/ADuM1301BRW | | | | | | |
| Minimum Pulse Width ² | PW | | | 100 | ns | $C_L = 15$ pF, CMOS signal levels |
| Maximum Data Rate ³ | | 10 | | | Mbps | $C_L = 15$ pF, CMOS signal levels |
| Propagation Delay ⁴ | t_{PHL} , t_{PLH} | 20 | 32 | 50 | ns | $C_L = 15$ pF, CMOS signal levels |
| Pulse Width Distortion, $ t_{PLH} - t_{PHL} $ ⁴ | PWD | | | 3 | ns | $C_L = 15$ pF, CMOS signal levels |
| Change vs. Temperature | | | 5 | | ps/°C | $C_L = 15$ pF, CMOS signal levels |
| Propagation Delay Skew ⁵ | t_{PSK} | | | 15 | ns | $C_L = 15$ pF, CMOS signal levels |
| Channel-to-Channel Matching, Codirectional Channels ⁶ | t_{PSKCD} | | | 3 | ns | $C_L = 15$ pF, CMOS signal levels |
| Channel-to-Channel Matching, Opposing-Directional Channels ⁶ | t_{PSKOD} | | | 6 | ns | $C_L = 15$ pF, CMOS signal levels |
| ADuM1300CRW/ADuM1301CRW | | | | | | |
| Minimum Pulse Width ² | PW | | 8.3 | 11.1 | ns | $C_L = 15$ pF, CMOS signal levels |
| Maximum Data Rate ³ | | 90 | 120 | | Mbps | $C_L = 15$ pF, CMOS signal levels |
| Propagation Delay ⁴ | t_{PHL} , t_{PLH} | 18 | 27 | 32 | ns | $C_L = 15$ pF, CMOS signal levels |
| Pulse Width Distortion, $ t_{PLH} - t_{PHL} $ ⁴ | PWD | | 0.5 | 2 | ns | $C_L = 15$ pF, CMOS signal levels |
| Change vs. Temperature | | | 3 | | ps/°C | $C_L = 15$ pF, CMOS signal levels |
| Propagation Delay Skew ⁵ | t_{PSK} | | | 10 | ns | $C_L = 15$ pF, CMOS signal levels |
| Channel-to-Channel Matching, Codirectional Channels ⁶ | t_{PSKCD} | | | 2 | ns | $C_L = 15$ pF, CMOS signal levels |
| Channel-to-Channel Matching, Opposing-Directional Channels ⁶ | t_{PSKOD} | | | 5 | ns | $C_L = 15$ pF, CMOS signal levels |
| For All Models | | | | | | |
| Output Disable Propagation Delay (High/Low to High Impedance) | t_{PHZ} , t_{PLH} | | 6 | 8 | ns | $C_L = 15$ pF, CMOS signal levels |
| Output Enable Propagation Delay (High Impedance to High/Low) | t_{PZH} , t_{PZL} | | 6 | 8 | ns | $C_L = 15$ pF, CMOS signal levels |
| Output Rise/Fall Time (10% to 90%) | t_R/t_F | | 2.5 | | ns | $C_L = 15$ pF, CMOS signal levels |
| Common-Mode Transient Immunity at Logic High Output ⁷ | $ CM_H $ | 25 | 35 | | kV/ μ s | $V_{IX} = V_{DD1}$ or V_{DD2} , $V_{CM} = 1000$ V, transient magnitude = 800 V |
| Common-Mode Transient Immunity at Logic Low Output ⁷ | $ CM_L $ | 25 | 35 | | kV/ μ s | $V_{IX} = 0$ V, $V_{CM} = 1000$ V, transient magnitude = 800 V |
| Refresh Rate | f_r | | 1.2 | | Mbps | |
| Input Dynamic Supply Current per Channel ⁸ | $I_{DDI(D)}$ | | 0.19 | | mA/Mbps | |
| Output Dynamic Supply Current per Channel ⁸ | $I_{DDO(D)}$ | | 0.05 | | mA/Mbps | |

¹ The supply current values are for all three channels combined when running at identical data rates. Output supply current values are specified with no output load present. The supply current associated with an individual channel operating at a given data rate may be calculated as described in the [Power Consumption](#) section. See [Figure 6](#) through [Figure 8](#) for information on per-channel supply current as a function of data rate for unloaded and loaded conditions. See [Figure 9](#) through [Figure 12](#) for total V_{DD1} and V_{DD2} supply currents as a function of data rate for ADuM1300/ADuM1301 channel configurations.

² The minimum pulse width is the shortest pulse width at which the specified pulse width distortion is guaranteed.

³ The maximum data rate is the fastest data rate at which the specified pulse width distortion is guaranteed.

⁴ t_{PHL} propagation delay is measured from the 50% level of the falling edge of the V_{IX} signal to the 50% level of the falling edge of the V_{OX} signal. t_{PLH} propagation delay is measured from the 50% level of the rising edge of the V_{IX} signal to the 50% level of the rising edge of the V_{OX} signal.

⁵ t_{PSK} is the magnitude of the worst-case difference in t_{PHL} or t_{PLH} that is measured between units at the same operating temperature, supply voltages, and output load within the recommended operating conditions.

⁶ Codirectional channel-to-channel matching is the absolute value of the difference in propagation delays between any two channels with inputs on the same side of the isolation barrier. Opposing-directional channel-to-channel matching is the absolute value of the difference in propagation delays between any two channels with inputs on opposing sides of the isolation barrier.

SPECIFICATIONS

- ⁷ CM_H is the maximum common-mode voltage slew rate that can be sustained while maintaining $V_O > 0.8 V_{DD2}$. CM_L is the maximum common-mode voltage slew rate that can be sustained while maintaining $V_O < 0.8 V$. The common-mode voltage slew rates apply to both rising and falling common-mode voltage edges. The transient magnitude is the range over which the common mode is slewed.
- ⁸ Dynamic supply current is the incremental amount of supply current required for a 1 Mbps increase in signal data rate. See Figure 6 through Figure 8 for information on per-channel supply current for unloaded and loaded conditions. See the Power Consumption section for guidance on calculating the per-channel supply current for a given data rate.

ELECTRICAL CHARACTERISTICS—3 V, 105°C OPERATION

All voltages are relative to their respective ground. $2.7 V \leq V_{DD1} \leq 3.6 V$, $2.7 V \leq V_{DD2} \leq 3.6 V$; all minimum/maximum specifications apply over the entire recommended operation range, unless otherwise noted; all typical specifications are at $T_A = 25^\circ C$, $V_{DD1} = V_{DD2} = 3.0 V$. These specifications do not apply to ADuM1300W and ADuM1301W automotive grade versions.

Table 2.

| Parameter | Symbol | Min | Typ | Max | Unit | Test Conditions/Comments |
|--|--|--------------------------------|-------|------|---------|--|
| DC SPECIFICATIONS | | | | | | |
| Input Supply Current per Channel, Quiescent | $I_{DD1(Q)}$ | | 0.26 | 0.31 | mA | |
| Output Supply Current per Channel, Quiescent | $I_{DDO(Q)}$ | | 0.11 | 0.15 | mA | |
| ADuM1300 Total Supply Current, Three Channels ¹ | | | | | | |
| DC to 2 Mbps | | | | | | |
| V_{DD1} Supply Current | $I_{DD1(Q)}$ | | 0.9 | 1.7 | mA | DC to 1 MHz logic signal freq. |
| V_{DD2} Supply Current | $I_{DD2(Q)}$ | | 0.4 | 0.7 | mA | DC to 1 MHz logic signal freq. |
| 10 Mbps (BRW and CRW Grades Only) | | | | | | |
| V_{DD1} Supply Current | $I_{DD1(10)}$ | | 3.4 | 4.9 | mA | 5 MHz logic signal freq. |
| V_{DD2} Supply Current | $I_{DD2(10)}$ | | 1.1 | 1.6 | mA | 5 MHz logic signal freq. |
| 90 Mbps (CRW Grade Only) | | | | | | |
| V_{DD1} Supply Current | $I_{DD1(90)}$ | | 31 | 48 | mA | 45 MHz logic signal freq. |
| V_{DD2} Supply Current | $I_{DD2(90)}$ | | 8 | 13 | mA | 45 MHz logic signal freq. |
| ADuM1301 Total Supply Current, Three Channels ¹ | | | | | | |
| DC to 2 Mbps | | | | | | |
| V_{DD1} Supply Current | $I_{DD1(Q)}$ | | 0.7 | 1.4 | mA | DC to 1 MHz logic signal freq. |
| V_{DD2} Supply Current | $I_{DD2(Q)}$ | | 0.6 | 0.9 | mA | DC to 1 MHz logic signal freq. |
| 10 Mbps (BRW and CRW Grades Only) | | | | | | |
| V_{DD1} Supply Current | $I_{DD1(10)}$ | | 2.6 | 3.7 | mA | 5 MHz logic signal freq. |
| V_{DD2} Supply Current | $I_{DD2(10)}$ | | 1.8 | 2.5 | mA | 5 MHz logic signal freq. |
| 90 Mbps (CRW Grade Only) | | | | | | |
| V_{DD1} Supply Current | $I_{DD1(90)}$ | | 24 | 36 | mA | 45 MHz logic signal freq. |
| V_{DD2} Supply Current | $I_{DD2(90)}$ | | 16 | 23 | mA | 45 MHz logic signal freq. |
| For All Models | | | | | | |
| Input Currents | $I_{IA}, I_{IB}, I_{IC}, I_{E1}, I_{E2}$ | -10 | +0.01 | +10 | μA | $0 V \leq V_{IA}, V_{IB}, V_{IC} \leq V_{DD1}$ or V_{DD2} , $0 V \leq V_{E1}, V_{E2} \leq V_{DD1}$ or V_{DD2} |
| Logic High Input Threshold | V_{IH}, V_{EH} | 1.6 | | | V | |
| Logic Low Input Threshold | V_{IL}, V_{EL} | | | 0.4 | V | |
| Logic High Output Voltages | $V_{OAH}, V_{OBH}, V_{OCH}$ | $(V_{DD1}$ or $V_{DD2}) - 0.1$ | 3.0 | | V | $I_{OX} = -20 \mu A, V_{IX} = V_{IXH}$ |
| | | $(V_{DD1}$ or $V_{DD2}) - 0.4$ | 2.8 | | V | $I_{OX} = -3.2 \text{ mA}, V_{IX} = V_{IXH}$ |
| Logic Low Output Voltages | $V_{OAL}, V_{OBL}, V_{OCL}$ | | 0.0 | 0.1 | V | $I_{OX} = 20 \mu A, V_{IX} = V_{IXL}$ |
| | | | 0.04 | 0.1 | V | $I_{OX} = 400 \mu A, V_{IX} = V_{IXL}$ |
| | | | 0.2 | 0.4 | V | $I_{OX} = 3.2 \text{ mA}, V_{IX} = V_{IXL}$ |
| SWITCHING SPECIFICATIONS | | | | | | |
| ADuM1300ARW/ADuM1301ARW | | | | | | |
| Minimum Pulse Width ² | PW | | | 1000 | ns | $C_L = 15 \text{ pF}$, CMOS signal levels |

SPECIFICATIONS

Table 2. (Continued)

| Parameter | Symbol | Min | Typ | Max | Unit | Test Conditions/Comments |
|---|-----------------------|-----|------|------|---------|--|
| Maximum Data Rate ³ | | 1 | | | Mbps | $C_L = 15$ pF, CMOS signal levels |
| Propagation Delay ⁴ | t_{PHL}, t_{PLH} | 50 | 75 | 100 | ns | $C_L = 15$ pF, CMOS signal levels |
| Pulse Width Distortion, $ t_{PLH} - t_{PHL} $ ⁴ | PWD | | | 40 | ns | $C_L = 15$ pF, CMOS signal levels |
| Change vs. Temperature | | | 11 | | ps/°C | $C_L = 15$ pF, CMOS signal levels |
| Propagation Delay Skew ⁵ | t_{PSK} | | | 50 | ns | $C_L = 15$ pF, CMOS signal levels |
| Channel-to-Channel Matching ⁶ | t_{PSKCD}/t_{PSKOD} | | | 50 | ns | $C_L = 15$ pF, CMOS signal levels |
| ADuM1300BRW/ADuM1301BRW | | | | | | |
| Minimum Pulse Width ² | PW | | | 100 | ns | $C_L = 15$ pF, CMOS signal levels |
| Maximum Data Rate ³ | | 10 | | | Mbps | $C_L = 15$ pF, CMOS signal levels |
| Propagation Delay ⁴ | t_{PHL}, t_{PLH} | 20 | 38 | 50 | ns | $C_L = 15$ pF, CMOS signal levels |
| Pulse Width Distortion, $ t_{PLH} - t_{PHL} $ ⁴ | PWD | | | 3 | ns | $C_L = 15$ pF, CMOS signal levels |
| Change vs. Temperature | | | 5 | | ps/°C | $C_L = 15$ pF, CMOS signal levels |
| Propagation Delay Skew ⁵ | t_{PSK} | | | 26 | ns | $C_L = 15$ pF, CMOS signal levels |
| Channel-to-Channel Matching, Codirectional Channels ⁶ | t_{PSKCD} | | | 3 | ns | $C_L = 15$ pF, CMOS signal levels |
| Channel-to-Channel Matching, Opposing-Directional Channels ⁶ | t_{PSKOD} | | | 6 | ns | $C_L = 15$ pF, CMOS signal levels |
| ADuM1300CRW/ADuM1301CRW | | | | | | |
| Minimum Pulse Width ² | PW | | 8.3 | 11.1 | ns | $C_L = 15$ pF, CMOS signal levels |
| Maximum Data Rate ³ | | 90 | 120 | | Mbps | $C_L = 15$ pF, CMOS signal levels |
| Propagation Delay ⁴ | t_{PHL}, t_{PLH} | 20 | 34 | 45 | ns | $C_L = 15$ pF, CMOS signal levels |
| Pulse Width Distortion, $ t_{PLH} - t_{PHL} $ ⁴ | PWD | | 0.5 | 2 | ns | $C_L = 15$ pF, CMOS signal levels |
| Change vs. Temperature | | | 3 | | ps/°C | $C_L = 15$ pF, CMOS signal levels |
| Propagation Delay Skew ⁵ | t_{PSK} | | | 16 | ns | $C_L = 15$ pF, CMOS signal levels |
| Channel-to-Channel Matching, Codirectional Channels ⁶ | t_{PSKCD} | | | 2 | ns | $C_L = 15$ pF, CMOS signal levels |
| Channel-to-Channel Matching, Opposing-Directional Channels ⁶ | t_{PSKOD} | | | 5 | ns | $C_L = 15$ pF, CMOS signal levels |
| For All Models | | | | | | |
| Output Disable Propagation Delay (High/Low to High Impedance) | t_{PHZ}, t_{PLH} | | 6 | 8 | ns | $C_L = 15$ pF, CMOS signal levels |
| Output Enable Propagation Delay (High Impedance to High/Low) | t_{PZH}, t_{PZL} | | 6 | 8 | ns | $C_L = 15$ pF, CMOS signal levels |
| Output Rise/Fall Time (10% to 90%) | t_R/t_F | | 3 | | ns | $C_L = 15$ pF, CMOS signal levels |
| Common-Mode Transient Immunity at Logic High Output ⁷ | $ CM_H $ | 25 | 35 | | kV/μs | $V_{IX} = V_{DD1}$ or V_{DD2} , $V_{CM} = 1000$ V, transient magnitude = 800 V |
| Common-Mode Transient Immunity at Logic Low Output ⁷ | $ CM_L $ | 25 | 35 | | kV/μs | $V_{IX} = 0$ V, $V_{CM} = 1000$ V, transient magnitude = 800 V |
| Refresh Rate | f_r | | 1.1 | | Mbps | |
| Input Dynamic Supply Current per Channel ⁸ | $I_{DDI(D)}$ | | 0.10 | | mA/Mbps | |
| Output Dynamic Supply Current per Channel ⁸ | $I_{DDO(D)}$ | | 0.03 | | mA/Mbps | |

¹ The supply current values are for all three channels combined when running at identical data rates. Output supply current values are specified with no output load present. The supply current associated with an individual channel operating at a given data rate may be calculated as described in the [Power Consumption](#) section. See [Figure 6](#) through [Figure 8](#) for information on per-channel supply current as a function of data rate for unloaded and loaded conditions. See [Figure 9](#) through [Figure 12](#) for total V_{DD1} and V_{DD2} supply currents as a function of data rate for ADuM1300/ADuM1301 channel configurations.

² The minimum pulse width is the shortest pulse width at which the specified pulse width distortion is guaranteed.

³ The maximum data rate is the fastest data rate at which the specified pulse width distortion is guaranteed.

⁴ t_{PHL} propagation delay is measured from the 50% level of the falling edge of the V_{IX} signal to the 50% level of the falling edge of the V_{OX} signal. t_{PLH} propagation delay is measured from the 50% level of the rising edge of the V_{IX} signal to the 50% level of the rising edge of the V_{OX} signal.

SPECIFICATIONS

- ⁵ t_{PSK} is the magnitude of the worst-case difference in t_{PHL} or t_{PLH} that is measured between units at the same operating temperature, supply voltages, and output load within the recommended operating conditions.
- ⁶ Codirectional channel-to-channel matching is the absolute value of the difference in propagation delays between any two channels with inputs on the same side of the isolation barrier. Opposing-directional channel-to-channel matching is the absolute value of the difference in propagation delays between any two channels with inputs on opposing sides of the isolation barrier.
- ⁷ CM_H is the maximum common-mode voltage slew rate that can be sustained while maintaining $V_O > 0.8 V_{DD2}$. CM_L is the maximum common-mode voltage slew rate that can be sustained while maintaining $V_O < 0.8 V$. The common-mode voltage slew rates apply to both rising and falling common-mode voltage edges. The transient magnitude is the range over which the common mode is slewed.
- ⁸ Dynamic supply current is the incremental amount of supply current required for a 1 Mbps increase in signal data rate. See Figure 6 through Figure 8 for information on per-channel supply current for unloaded and loaded conditions. See the [Power Consumption](#) section for guidance on calculating the per-channel supply current for a given data rate.

ELECTRICAL CHARACTERISTICS—MIXED 5 V/3 V OR 3 V/5 V, 105°C OPERATION

All voltages are relative to their respective ground. 5 V/3 V operation: $4.5 V \leq V_{DD1} \leq 5.5 V$, $2.7 V \leq V_{DD2} \leq 3.6 V$; 3 V/5 V operation: $2.7 V \leq V_{DD1} \leq 3.6 V$, $4.5 V \leq V_{DD2} \leq 5.5 V$; all minimum/maximum specifications apply over the entire recommended operation range, unless otherwise noted; all typical specifications are at $T_A = 25^\circ C$; $V_{DD1} = 3.0 V$, $V_{DD2} = 5 V$ or $V_{DD1} = 5 V$, $V_{DD2} = 3.0 V$. These specifications do not apply to ADuM1300W and ADuM1301W automotive grade versions.

Table 3.

| Parameter | Symbol | Min | Typ | Max | Unit | Test Conditions/Comments |
|--|---------------|-----|------|------|------|--------------------------------|
| DC SPECIFICATIONS | | | | | | |
| Input Supply Current per Channel, Quiescent | $I_{DD1(Q)}$ | | | | | |
| 5 V/3 V Operation | | | 0.50 | 0.53 | mA | |
| 3 V/5 V Operation | | | 0.26 | 0.31 | mA | |
| Output Supply Current per Channel, Quiescent | $I_{DDO(Q)}$ | | | | | |
| 5 V/3 V Operation | | | 0.11 | 0.15 | mA | |
| 3 V/5 V Operation | | | 0.19 | 0.24 | mA | |
| ADuM1300 Total Supply Current, Three Channels ¹ | | | | | | |
| DC to 2 Mbps | | | | | | |
| V_{DD1} Supply Current | $I_{DD1(Q)}$ | | | | | |
| 5 V/3 V Operation | | | 1.6 | 2.5 | mA | DC to 1 MHz logic signal freq. |
| 3 V/5 V Operation | | | 0.9 | 1.7 | mA | DC to 1 MHz logic signal freq. |
| V_{DD2} Supply Current | $I_{DD2(Q)}$ | | | | | |
| 5 V/3 V Operation | | | 0.4 | 0.7 | mA | DC to 1 MHz logic signal freq. |
| 3 V/5 V Operation | | | 0.7 | 1.0 | mA | DC to 1 MHz logic signal freq. |
| 10 Mbps (BRW and CRW Grades Only) | | | | | | |
| V_{DD1} Supply Current | $I_{DD1(10)}$ | | | | | |
| 5 V/3 V Operation | | | 6.5 | 8.1 | mA | 5 MHz logic signal freq. |
| 3 V/5 V Operation | | | 3.4 | 4.9 | mA | 5 MHz logic signal freq. |
| V_{DD2} Supply Current | $I_{DD2(10)}$ | | | | | |
| 5 V/3 V Operation | | | 1.1 | 1.6 | mA | 5 MHz logic signal freq. |
| 3 V/5 V Operation | | | 1.9 | 2.5 | mA | 5 MHz logic signal freq. |
| 90 Mbps (CRW Grade Only) | | | | | | |
| V_{DD1} Supply Current | $I_{DD1(90)}$ | | | | | |
| 5 V/3 V Operation | | | 57 | 77 | mA | 45 MHz logic signal freq. |
| 3 V/5 V Operation | | | 31 | 48 | mA | 45 MHz logic signal freq. |

SPECIFICATIONS

Table 3. (Continued)

| Parameter | Symbol | Min | Typ | Max | Unit | Test Conditions/Comments |
|---|---|---|---|------|-------|--|
| V _{DD2} Supply Current | I _{DD2} (90) | | | | | |
| 5 V/3 V Operation | | | 8 | 13 | mA | 45 MHz logic signal freq. |
| 3 V/5 V Operation | | | 16 | 18 | mA | 45 MHz logic signal freq. |
| ADuM1301 Total Supply Current, Three Channels ¹ | | | | | | |
| DC to 2 Mbps | | | | | | |
| V _{DD1} Supply Current | I _{DD1} (Q) | | | | | |
| 5 V/3 V Operation | | | 1.3 | 2.1 | mA | DC to 1 MHz logic signal freq. |
| 3 V/5 V Operation | | | 0.7 | 1.4 | mA | DC to 1 MHz logic signal freq. |
| V _{DD2} Supply Current | I _{DD2} (Q) | | | | | |
| 5 V/3 V Operation | | | 0.6 | 0.9 | mA | DC to 1 MHz logic signal freq. |
| 3 V/5 V Operation | | | 1.0 | 1.4 | mA | DC to 1 MHz logic signal freq. |
| 10 Mbps (BRW and CRW Grades Only) | | | | | | |
| V _{DD1} Supply Current | I _{DD1} (10) | | | | | |
| 5 V/3 V Operation | | | 5.0 | 6.2 | mA | 5 MHz logic signal freq. |
| 3 V/5 V Operation | | | 2.6 | 3.7 | mA | 5 MHz logic signal freq. |
| V _{DD2} Supply Current | I _{DD2} (10) | | | | | |
| 5 V/3 V Operation | | | 1.8 | 2.5 | mA | 5 MHz logic signal freq. |
| 3 V/5 V Operation | | | 3.4 | 4.2 | mA | 5 MHz logic signal freq. |
| 90 Mbps (CRW Grade Only) | | | | | | |
| V _{DD1} Supply Current | I _{DD1} (90) | | | | | |
| 5 V/3 V Operation | | | 43 | 57 | mA | 45 MHz logic signal freq. |
| 3 V/5 V Operation | | | 24 | 36 | mA | 45 MHz logic signal freq. |
| V _{DD2} Supply Current | I _{DD2} (90) | | | | | |
| 5 V/3 V Operation | | | 16 | 23 | mA | 45 MHz logic signal freq. |
| 3 V/5 V Operation | | | 29 | 37 | mA | 45 MHz logic signal freq. |
| For All Models | | | | | | |
| Input Currents | I _{IA} , I _{IB} , I _{IC} , I _{E1} , I _{E2} | -10 | +0.01 | +10 | μA | 0 V ≤ V _{IA} , V _{IB} , V _{IC} ≤ V _{DD1} or V _{DD2} , 0 V ≤ V _{E1} , V _{E2} ≤ V _{DD1} or V _{DD2} |
| Logic High Input Threshold | V _{IH} , V _{EH} | | | | V | |
| 5 V/3 V Operation | | 2.0 | | | V | |
| 3 V/5 V Operation | | 1.6 | | | V | |
| Logic Low Input Threshold | V _{IL} , V _{EL} | | | | V | |
| 5 V/3 V Operation | | | | 0.8 | V | |
| 3 V/5 V Operation | | | | 0.4 | V | |
| Logic High Output Voltages | V _{OAH} , V _{OBH} , V _{OCH} | (V _{DD1} or V _{DD2}) - 0.1 | (V _{DD1} or V _{DD2}) | | V | I _{Ox} = -20 μA, V _{Ix} = V _{IxH} |
| | | (V _{DD1} or V _{DD2}) - 0.4 | (V _{DD1} or V _{DD2}) - 0.2 | | V | I _{Ox} = -3.2 mA, V _{Ix} = V _{IxH} |
| Logic Low Output Voltages | V _{OAL} , V _{OBL} , V _{OCL} | | 0.0 | 0.1 | V | I _{Ox} = 20 μA, V _{Ix} = V _{IxL} |
| | | | 0.04 | 0.1 | V | I _{Ox} = 400 μA, V _{Ix} = V _{IxL} |
| | | | 0.2 | 0.4 | V | I _{Ox} = 3.2 mA, V _{Ix} = V _{IxL} |
| SWITCHING SPECIFICATIONS | | | | | | |
| ADuM1300ARW/ADuM1301ARW | | | | | | |
| Minimum Pulse Width ² | PW | | | 1000 | ns | C _L = 15 pF, CMOS signal levels |
| Maximum Data Rate ³ | | 1 | | | Mbps | C _L = 15 pF, CMOS signal levels |
| Propagation Delay ⁴ | t _{PHL} , t _{PLH} | 50 | 70 | 100 | ns | C _L = 15 pF, CMOS signal levels |
| Pulse Width Distortion, t _{PLH} - t _{PHL} ⁴ | PWD | | | 40 | ns | C _L = 15 pF, CMOS signal levels |
| Change vs. Temperature | | | 11 | | ps/°C | C _L = 15 pF, CMOS signal levels |
| Propagation Delay Skew ⁵ | t _{PSK} | | | 50 | ns | C _L = 15 pF, CMOS signal levels |
| Channel-to-Channel Matching ⁶ | t _{PSKCD} /t _{PSKOD} | | | 50 | ns | C _L = 15 pF, CMOS signal levels |

SPECIFICATIONS

Table 3. (Continued)

| Parameter | Symbol | Min | Typ | Max | Unit | Test Conditions/Comments |
|---|--------------------|-----|------|------|-------------|--|
| ADuM1300BRW/ADuM1301BRW | | | | | | |
| Minimum Pulse Width ² | PW | | | 100 | ns | $C_L = 15$ pF, CMOS signal levels |
| Maximum Data Rate ³ | | 10 | | | Mbps | $C_L = 15$ pF, CMOS signal levels |
| Propagation Delay ⁴ | t_{PHL}, t_{PLH} | 15 | 35 | 50 | ns | $C_L = 15$ pF, CMOS signal levels |
| Pulse Width Distortion, $ t_{PLH} - t_{PHL} $ ⁴ | PWD | | | 3 | ns | $C_L = 15$ pF, CMOS signal levels |
| Change vs. Temperature | | | 5 | | ps/°C | $C_L = 15$ pF, CMOS signal levels |
| Propagation Delay Skew ⁵ | t_{PSK} | | | 6 | ns | $C_L = 15$ pF, CMOS signal levels |
| Channel-to-Channel Matching, Codirectional Channels ⁶ | t_{PSKCD} | | | 3 | ns | $C_L = 15$ pF, CMOS signal levels |
| Channel-to-Channel Matching, Opposing-Directional Channels ⁶ | t_{PSKOD} | | | 22 | ns | $C_L = 15$ pF, CMOS signal levels |
| ADuM1300CRW/ADuM1301CRW | | | | | | |
| Minimum Pulse Width ² | PW | | 8.3 | 11.1 | ns | $C_L = 15$ pF, CMOS signal levels |
| Maximum Data Rate ³ | | 90 | 120 | | Mbps | $C_L = 15$ pF, CMOS signal levels |
| Propagation Delay ⁴ | t_{PHL}, t_{PLH} | 20 | 30 | 40 | ns | $C_L = 15$ pF, CMOS signal levels |
| Pulse Width Distortion, $ t_{PLH} - t_{PHL} $ ⁴ | PWD | | 0.5 | 2 | ns | $C_L = 15$ pF, CMOS signal levels |
| Change vs. Temperature | | | 3 | | ps/°C | $C_L = 15$ pF, CMOS signal levels |
| Propagation Delay Skew ⁵ | t_{PSK} | | | 14 | ns | $C_L = 15$ pF, CMOS signal levels |
| Channel-to-Channel Matching, Codirectional Channels ⁶ | t_{PSKCD} | | | 2 | ns | $C_L = 15$ pF, CMOS signal levels |
| Channel-to-Channel Matching, Opposing-Directional Channels ⁶ | t_{PSKOD} | | | 5 | ns | $C_L = 15$ pF, CMOS signal levels |
| For All Models | | | | | | |
| Output Disable Propagation Delay (High/Low to High Impedance) | t_{PHZ}, t_{PLH} | | 6 | 8 | ns | $C_L = 15$ pF, CMOS signal levels |
| Output Enable Propagation Delay (High Impedance to High/Low) | t_{PZH}, t_{PZL} | | 6 | 8 | ns | $C_L = 15$ pF, CMOS signal levels |
| Output Rise/Fall Time (10% to 90%) | t_R/t_F | | | | | $C_L = 15$ pF, CMOS signal levels |
| 5 V/3 V Operation | | | 3.0 | | ns | |
| 3 V/5 V Operation | | | 2.5 | | ns | |
| Common-Mode Transient Immunity at Logic High Output ⁷ | $ CM_H $ | 25 | 35 | | kV/ μ s | $V_{IX} = V_{DD1}$ or V_{DD2} , $V_{CM} = 1000$ V, transient magnitude = 800 V |
| Common-Mode Transient Immunity at Logic Low Output ⁷ | $ CM_L $ | 25 | 35 | | kV/ μ s | $V_{IX} = 0$ V, $V_{CM} = 1000$ V, transient magnitude = 800 V |
| Refresh Rate | f_r | | | | | |
| 5 V/3 V Operation | | | 1.2 | | Mbps | |
| 3 V/5 V Operation | | | 1.1 | | Mbps | |
| Input Dynamic Supply Current per Channel ⁸ | $I_{DDI(D)}$ | | | | | |
| 5 V/3 V Operation | | | 0.19 | | mA/Mbps | |
| 3 V/5 V Operation | | | 0.10 | | mA/Mbps | |
| Output Dynamic Supply Current per Channel ⁸ | $I_{DDO(D)}$ | | | | | |
| 5 V/3 V Operation | | | 0.03 | | mA/Mbps | |
| 3 V/5 V Operation | | | 0.05 | | mA/Mbps | |

¹ The supply current values are for all three channels combined when running at identical data rates. Output supply current values are specified with no output load present. The supply current associated with an individual channel operating at a given data rate may be calculated as described in the [Power Consumption](#) section. See [Figure 6](#) through [Figure 8](#) for information on per-channel supply current as a function of data rate for unloaded and loaded conditions. See [Figure 9](#) through [Figure 12](#) for total V_{DD1} and V_{DD2} supply currents as a function of data rate for ADuM1300/ADuM1301 channel configurations.

SPECIFICATIONS

- ² The minimum pulse width is the shortest pulse width at which the specified pulse width distortion is guaranteed.
- ³ The maximum data rate is the fastest data rate at which the specified pulse width distortion is guaranteed.
- ⁴ t_{PHL} propagation delay is measured from the 50% level of the falling edge of the V_{IX} signal to the 50% level of the falling edge of the V_{OX} signal. t_{PLH} propagation delay is measured from the 50% level of the rising edge of the V_{IX} signal to the 50% level of the rising edge of the V_{OX} signal.
- ⁵ t_{PSK} is the magnitude of the worst-case difference in t_{PHL} or t_{PLH} that is measured between units at the same operating temperature, supply voltages, and output load within the recommended operating conditions.
- ⁶ Codirectional channel-to-channel matching is the absolute value of the difference in propagation delays between any two channels with inputs on the same side of the isolation barrier. Opposing-directional channel-to-channel matching is the absolute value of the difference in propagation delays between any two channels with inputs on opposing sides of the isolation barrier.
- ⁷ CM_H is the maximum common-mode voltage slew rate that can be sustained while maintaining $V_O > 0.8 V_{DD2}$. CM_L is the maximum common-mode voltage slew rate that can be sustained while maintaining $V_O < 0.8 V$. The common-mode voltage slew rates apply to both rising and falling common-mode voltage edges. The transient magnitude is the range over which the common mode is slewed.
- ⁸ Dynamic supply current is the incremental amount of supply current required for a 1 Mbps increase in signal data rate. See Figure 6 through Figure 8 for information on per-channel supply current for unloaded and loaded conditions. See the [Power Consumption](#) section for guidance on calculating the per-channel supply current for a given data rate.

ELECTRICAL CHARACTERISTICS—5 V, 125°C OPERATION

All voltages are relative to their respective ground. $4.5 V \leq V_{DD1} \leq 5.5 V$, $4.5 V \leq V_{DD2} \leq 5.5 V$; all minimum/maximum specifications apply over the entire recommended operation range, unless otherwise noted; all typical specifications are at $T_A = 25^\circ C$, $V_{DD1} = V_{DD2} = 5 V$. These specifications apply to ADuM1300W and ADuM1301W automotive grade versions.

Table 4.

| Parameter | Symbol | Min | Typ | Max | Unit | Test Conditions/Comments |
|--|--|--------------------------|-------|------|---------|--|
| DC SPECIFICATIONS | | | | | | |
| Input Supply Current per Channel, Quiescent | $I_{DD1(Q)}$ | | 0.50 | 0.53 | mA | |
| Output Supply Current per Channel, Quiescent | $I_{DD0(Q)}$ | | 0.19 | 0.24 | mA | |
| ADuM1300W, Total Supply Current, Three Channels ¹ | | | | | | |
| DC to 2 Mbps | | | | | | |
| V_{DD1} Supply Current | $I_{DD1(Q)}$ | | 1.6 | 2.5 | mA | DC to 1 MHz logic signal freq. |
| V_{DD2} Supply Current | $I_{DD2(Q)}$ | | 0.7 | 1.0 | mA | DC to 1 MHz logic signal freq. |
| 10 Mbps (TRWZ Grade Only) | | | | | | |
| V_{DD1} Supply Current | $I_{DD1(10)}$ | | 6.5 | 8.1 | mA | 5 MHz logic signal freq. |
| V_{DD2} Supply Current | $I_{DD2(10)}$ | | 1.9 | 2.5 | mA | 5 MHz logic signal freq. |
| ADuM1301W, Total Supply Current, Three Channels ¹ | | | | | | |
| DC to 2 Mbps | | | | | | |
| V_{DD1} Supply Current | $I_{DD1(Q)}$ | | 1.3 | 2.1 | mA | DC to 1 MHz logic signal freq. |
| V_{DD2} Supply Current | $I_{DD2(Q)}$ | | 1.0 | 1.4 | mA | DC to 1 MHz logic signal freq. |
| 10 Mbps (TRWZ Grade Only) | | | | | | |
| V_{DD1} Supply Current | $I_{DD1(10)}$ | | 5.0 | 6.2 | mA | 5 MHz logic signal freq. |
| V_{DD2} Supply Current | $I_{DD2(10)}$ | | 3.4 | 4.2 | mA | 5 MHz logic signal freq. |
| For All Models | | | | | | |
| Input Currents | $I_{IA}, I_{IB}, I_{IC}, I_{E1}, I_{E2}$ | -10 | +0.01 | +10 | μA | $0 V \leq V_{IA}, V_{IB}, V_{IC} \leq V_{DD1}$ or V_{DD2} , $0 V \leq V_{E1}, V_{E2} \leq V_{DD1}$ or V_{DD2} |
| Logic High Input Threshold | V_{IH}, V_{EH} | 2.0 | | | V | |
| Logic Low Input Threshold | V_{IL}, V_{EL} | | | 0.8 | V | |
| Logic High Output Voltages | $V_{OAH}, V_{OBH}, V_{OCH}$ | $V_{DD1}, V_{DD2} - 0.1$ | 5.0 | | V | $I_{OX} = -20 \mu A, V_{IX} = V_{IXH}$ |
| | | $V_{DD1}, V_{DD2} - 0.4$ | 4.8 | | V | $I_{OX} = -3.2 mA, V_{IX} = V_{IXH}$ |
| Logic Low Output Voltages | $V_{OAL}, V_{OBL}, V_{OCL}$ | | 0.0 | 0.1 | V | $I_{OX} = 20 \mu A, V_{IX} = V_{IXL}$ |
| | | | 0.04 | 0.1 | V | $I_{OX} = 400 \mu A, V_{IX} = V_{IXL}$ |
| | | | 0.2 | 0.4 | V | $I_{OX} = 3.2 mA, V_{IX} = V_{IXL}$ |

SPECIFICATIONS

Table 4. (Continued)

| Parameter | Symbol | Min | Typ | Max | Unit | Test Conditions/Comments |
|---|-----------------------|-----|------|------|-------------|---|
| SWITCHING SPECIFICATIONS | | | | | | |
| ADuM1300WSRWZ/ADuM1301WSRWZ | | | | | | |
| Minimum Pulse Width ² | PW | | | 1000 | ns | $C_L = 15$ pF, CMOS signal levels |
| Maximum Data Rate ³ | | 1 | | | Mbps | $C_L = 15$ pF, CMOS signal levels |
| Propagation Delay ⁴ | t_{PHL}, t_{PLH} | 50 | 65 | 100 | ns | $C_L = 15$ pF, CMOS signal levels |
| Pulse Width Distortion, $ t_{PLH} - t_{PHL} $ ⁴ | PWD | | | 40 | ns | $C_L = 15$ pF, CMOS signal levels |
| Propagation Delay Skew ⁵ | t_{PSK} | | | 50 | ns | $C_L = 15$ pF, CMOS signal levels |
| Channel-to-Channel Matching ⁶ | t_{PSKCD}/t_{PSKOD} | | | 50 | ns | $C_L = 15$ pF, CMOS signal levels |
| ADuM1300WTRWZ/ADuM1301WTRWZ | | | | | | |
| Minimum Pulse Width ² | PW | | | 100 | ns | $C_L = 15$ pF, CMOS signal levels |
| Maximum Data Rate ³ | | 10 | | | Mbps | $C_L = 15$ pF, CMOS signal levels |
| Propagation Delay ⁴ | t_{PHL}, t_{PLH} | 18 | 27 | 32 | ns | $C_L = 15$ pF, CMOS signal levels |
| Pulse Width Distortion, $ t_{PLH} - t_{PHL} $ ⁴ | PWD | | | 3 | ns | $C_L = 15$ pF, CMOS signal levels |
| Change vs. Temperature | | | 5 | | ps/°C | $C_L = 15$ pF, CMOS signal levels |
| Propagation Delay Skew ⁵ | t_{PSK} | | | 15 | ns | $C_L = 15$ pF, CMOS signal levels |
| Channel-to-Channel Matching, Codirectional Channels ⁶ | t_{PSKCD} | | | 3 | ns | $C_L = 15$ pF, CMOS signal levels |
| Channel-to-Channel Matching, Opposing-Directional Channels ⁶ | t_{PSKOD} | | | 6 | ns | $C_L = 15$ pF, CMOS signal levels |
| For All Models | | | | | | |
| Output Disable Propagation Delay(High/Low to High Impedance) | t_{PHZ}, t_{PLH} | | 6 | 8 | ns | $C_L = 15$ pF, CMOS signal levels |
| Output Enable Propagation Delay (High Impedance to High/Low) | t_{PZH}, t_{PZL} | | 6 | 8 | ns | $C_L = 15$ pF, CMOS signal levels |
| Output Rise/Fall Time (10% to 90%) | t_R/t_F | | 2.5 | | ns | $C_L = 15$ pF, CMOS signal levels |
| Common-Mode Transient Immunity at Logic High Output ⁷ | $ CM_H $ | 25 | 35 | | kV/ μ s | $V_{IX} = V_{DD1}/V_{DD2}$, $V_{CM} = 1000$ V, transient magnitude = 800 V |
| Common-Mode Transient Immunity at Logic Low Output ⁷ | $ CM_L $ | 25 | 35 | | kV/ μ s | $V_{IX} = 0$ V, $V_{CM} = 1000$ V, transient magnitude = 800 V |
| Refresh Rate | f_r | | 1.2 | | Mbps | |
| Input Dynamic Supply Current per Channel ⁸ | $I_{DDI}(D)$ | | 0.19 | | mA/Mbps | |
| Output Dynamic Supply Current per Channel ⁸ | $I_{DDO}(D)$ | | 0.05 | | mA/Mbps | |

¹ The supply current values are for all three channels combined when running at identical data rates. Output supply current values are specified with no output load present. The supply current associated with an individual channel operating at a given data rate may be calculated as described in the Power Consumption section. See Figure 6 through Figure 8 for information on per-channel supply current as a function of data rate for unloaded and loaded conditions. See Figure 9 through Figure 12 for total V_{DD1} and V_{DD2} supply currents as a function of data rate for ADuM1300W/ADuM1301W channel configurations.

² The minimum pulse width is the shortest pulse width at which the specified pulse width distortion is guaranteed.

³ The maximum data rate is the fastest data rate at which the specified pulse width distortion is guaranteed.

⁴ t_{PHL} propagation delay is measured from the 50% level of the falling edge of the V_{IX} signal to the 50% level of the falling edge of the V_{OX} signal. t_{PLH} propagation delay is measured from the 50% level of the rising edge of the V_{IX} signal to the 50% level of the rising edge of the V_{OX} signal.

⁵ t_{PSK} is the magnitude of the worst-case difference in t_{PHL} or t_{PLH} that is measured between units at the same operating temperature, supply voltages, and output load within the recommended operating conditions.

⁶ Codirectional channel-to-channel matching is the absolute value of the difference in propagation delays between any two channels with inputs on the same side of the isolation barrier. Opposing-directional channel-to-channel matching is the absolute value of the difference in propagation delays between any two channels with inputs on opposing sides of the isolation barrier.

⁷ CM_H is the maximum common-mode voltage slew rate that can be sustained while maintaining $V_O > 0.8 V_{DD2}$. CM_L is the maximum common-mode voltage slew rate that can be sustained while maintaining $V_O < 0.8$ V. The common-mode voltage slew rates apply to both rising and falling common-mode voltage edges. The transient magnitude is the range over which the common mode is slewed.

SPECIFICATIONS

⁸ Dynamic supply current is the incremental amount of supply current required for a 1 Mbps increase in signal data rate. See Figure 6 through Figure 8 for information on per-channel supply current for unloaded and loaded conditions. See the Power Consumption section for guidance on calculating the per-channel supply current for a given data rate.

ELECTRICAL CHARACTERISTICS—3 V, 125°C OPERATION

All voltages are relative to their respective ground. $3.0\text{ V} \leq V_{DD1} \leq 3.6\text{ V}$, $3.0\text{ V} \leq V_{DD2} \leq 3.6\text{ V}$; all minimum/maximum specifications apply over the entire recommended operation range, unless otherwise noted; all typical specifications are at $T_A = 25^\circ\text{C}$, $V_{DD1} = V_{DD2} = 3.0\text{ V}$. These specifications apply to ADuM1300W and ADuM1301W automotive grade versions.

Table 5.

| Parameter | Symbol | Min | Typ | Max | Unit | Test Conditions/Comments |
|--|--|--------------------------|-------|------|---------------|--|
| DC SPECIFICATIONS | | | | | | |
| Input Supply Current per Channel, Quiescent | $I_{DD1(Q)}$ | | 0.26 | 0.31 | mA | |
| Output Supply Current per Channel, Quiescent | $I_{DD0(Q)}$ | | 0.11 | 0.15 | mA | |
| ADuM1300W, Total Supply Current, Three Channels ¹ | | | | | | |
| DC to 2 Mbps | | | | | | |
| V_{DD1} Supply Current | $I_{DD1(Q)}$ | | 0.9 | 1.7 | mA | DC to 1 MHz logic signal freq. |
| V_{DD2} Supply Current | $I_{DD2(Q)}$ | | 0.4 | 0.7 | mA | DC to 1 MHz logic signal freq. |
| 10 Mbps (TRWZ Grade Only) | | | | | | |
| V_{DD1} Supply Current | $I_{DD1(10)}$ | | 3.4 | 4.9 | mA | 5 MHz logic signal freq. |
| V_{DD2} Supply Current | $I_{DD2(10)}$ | | 1.1 | 1.6 | mA | 5 MHz logic signal freq. |
| ADuM1301W, Total Supply Current, Three Channels ¹ | | | | | | |
| DC to 2 Mbps | | | | | | |
| V_{DD1} Supply Current | $I_{DD1(Q)}$ | | 0.7 | 1.4 | mA | DC to 1 MHz logic signal freq. |
| V_{DD2} Supply Current | $I_{DD2(Q)}$ | | 0.6 | 0.9 | mA | DC to 1 MHz logic signal freq. |
| 10 Mbps (TRWZ Grade Only) | | | | | | |
| V_{DD1} Supply Current | $I_{DD1(10)}$ | | 2.6 | 3.7 | mA | 5 MHz logic signal freq. |
| V_{DD2} Supply Current | $I_{DD2(10)}$ | | 1.8 | 2.5 | mA | 5 MHz logic signal freq. |
| For All Models | | | | | | |
| Input Currents | $I_{IA}, I_{IB}, I_{IC}, I_{E1}, I_{E2}$ | -10 | +0.01 | +10 | μA | $0\text{ V} \leq V_{IA}, V_{IB}, V_{IC} \leq V_{DD1}$ or V_{DD2} , $0\text{ V} \leq V_{E1}, V_{E2} \leq V_{DD1}$ or V_{DD2} |
| Logic High Input Threshold | V_{IH}, V_{EH} | 1.6 | | | V | |
| Logic Low Input Threshold | V_{IL}, V_{EL} | | | 0.4 | V | |
| Logic High Output Voltages | $V_{OAH}, V_{OBH}, V_{OCH}$ | $V_{DD1}, V_{DD2} - 0.1$ | 3.0 | | V | $I_{OX} = -20\ \mu\text{A}, V_{IX} = V_{IXH}$ |
| | | $V_{DD1}, V_{DD2} - 0.4$ | 2.8 | | V | $I_{OX} = -3.2\ \text{mA}, V_{IX} = V_{IXH}$ |
| Logic Low Output Voltages | $V_{OAL}, V_{OBL}, V_{OCL}$ | | 0.0 | 0.1 | V | $I_{OX} = 20\ \mu\text{A}, V_{IX} = V_{IXL}$ |
| | | | 0.04 | 0.1 | V | $I_{OX} = 400\ \mu\text{A}, V_{IX} = V_{IXL}$ |
| | | | 0.2 | 0.4 | V | $I_{OX} = 3.2\ \text{mA}, V_{IX} = V_{IXL}$ |
| SWITCHING SPECIFICATIONS | | | | | | |
| ADuM1300WSRWZ/ADuM1301WSRWZ | | | | | | |
| Minimum Pulse Width ² | PW | | | 1000 | ns | $C_L = 15\ \text{pF}$, CMOS signal levels |
| Maximum Data Rate ³ | | 1 | | | Mbps | $C_L = 15\ \text{pF}$, CMOS signal levels |
| Propagation Delay ⁴ | t_{PHL}, t_{PLH} | 50 | 75 | 100 | ns | $C_L = 15\ \text{pF}$, CMOS signal levels |
| Pulse Width Distortion, $ t_{PLH} - t_{PHL} $ ⁴ | PWD | | | 40 | ns | $C_L = 15\ \text{pF}$, CMOS signal levels |
| Propagation Delay Skew ⁵ | t_{PSK} | | | 50 | ns | $C_L = 15\ \text{pF}$, CMOS signal levels |
| Channel-to-Channel Matching ⁶ | t_{PSKCD}/t_{PSKOD} | | | 50 | ns | $C_L = 15\ \text{pF}$, CMOS signal levels |
| ADuM1300WTRWZ/ADuM1301WTRWZ | | | | | | |
| Minimum Pulse Width ² | PW | | | 100 | ns | $C_L = 15\ \text{pF}$, CMOS signal levels |
| Maximum Data Rate ³ | | 10 | | | Mbps | $C_L = 15\ \text{pF}$, CMOS signal levels |
| Propagation Delay ⁴ | t_{PHL}, t_{PLH} | 20 | 34 | 45 | ns | $C_L = 15\ \text{pF}$, CMOS signal levels |

SPECIFICATIONS

Table 5. (Continued)

| Parameter | Symbol | Min | Typ | Max | Unit | Test Conditions/Comments |
|---|--------------------|-----|------|-----|---------|---|
| Pulse Width Distortion, $ t_{PLH} - t_{PHL} ^4$ | PWD | | | 3 | ns | $C_L = 15$ pF, CMOS signal levels |
| Change vs. Temperature | | | 5 | | ps/°C | $C_L = 15$ pF, CMOS signal levels |
| Propagation Delay Skew ⁵ | t_{PSK} | | | 26 | ns | $C_L = 15$ pF, CMOS signal levels |
| Channel-to-Channel Matching, Codirectional Channels ⁶ | t_{PSKCD} | | | 3 | ns | $C_L = 15$ pF, CMOS signal levels |
| Channel-to-Channel Matching, Opposing-Directional Channels ⁶ | t_{PSKOD} | | | 6 | ns | $C_L = 15$ pF, CMOS signal levels |
| For All Models | | | | | | |
| Output Disable Propagation Delay (High/Low to High Impedance) | t_{PHZ}, t_{PLH} | | 6 | 8 | ns | $C_L = 15$ pF, CMOS signal levels |
| Output Enable Propagation Delay (High Impedance to High/Low) | t_{PZH}, t_{PZL} | | 6 | 8 | ns | $C_L = 15$ pF, CMOS signal levels |
| Output Rise/Fall Time (10% to 90%) | t_R/t_F | | 3 | | ns | $C_L = 15$ pF, CMOS signal levels |
| Common-Mode Transient Immunity at Logic High Output ⁷ | $ CM_H $ | 25 | 35 | | kV/μs | $V_{IX} = V_{DD1}/V_{DD2}$, $V_{CM} = 1000$ V, transient magnitude = 800 V |
| Common-Mode Transient Immunity at Logic Low Output ⁷ | $ CM_L $ | 25 | 35 | | kV/μs | $V_{IX} = 0$ V, $V_{CM} = 1000$ V, transient magnitude = 800 V |
| Refresh Rate | f_r | | 1.1 | | Mbps | |
| Input Dynamic Supply Current per Channel ⁸ | $I_{DDI(D)}$ | | 0.10 | | mA/Mbps | |
| Output Dynamic Supply Current per Channel ⁸ | $I_{DDO(D)}$ | | 0.03 | | mA/Mbps | |

¹ The supply current values are for all three channels combined when running at identical data rates. Output supply current values are specified with no output load present. The supply current associated with an individual channel operating at a given data rate may be calculated as described in the [Power Consumption](#) section. See [Figure 6](#) through [Figure 8](#) for information on per-channel supply current as a function of data rate for unloaded and loaded conditions. See [Figure 9](#) through [Figure 12](#) for total V_{DD1} and V_{DD2} supply currents as a function of data rate for ADuM1300W/ADuM1301W channel configurations.

² The minimum pulse width is the shortest pulse width at which the specified pulse width distortion is guaranteed.

³ The maximum data rate is the fastest data rate at which the specified pulse width distortion is guaranteed.

⁴ t_{PHL} propagation delay is measured from the 50% level of the falling edge of the V_{IX} signal to the 50% level of the falling edge of the V_{OX} signal. t_{PLH} propagation delay is measured from the 50% level of the rising edge of the V_{IX} signal to the 50% level of the rising edge of the V_{OX} signal.

⁵ t_{PSK} is the magnitude of the worst-case difference in t_{PHL} or t_{PLH} that is measured between units at the same operating temperature, supply voltages, and output load within the recommended operating conditions.

⁶ Codirectional channel-to-channel matching is the absolute value of the difference in propagation delays between any two channels with inputs on the same side of the isolation barrier. Opposing-directional channel-to-channel matching is the absolute value of the difference in propagation delays between any two channels with inputs on opposing sides of the isolation barrier.

⁷ CM_H is the maximum common-mode voltage slew rate that can be sustained while maintaining $V_O > 0.8 V_{DD2}$. CM_L is the maximum common-mode voltage slew rate that can be sustained while maintaining $V_O < 0.8$ V. The common-mode voltage slew rates apply to both rising and falling common-mode voltage edges. The transient magnitude is the range over which the common mode is slewed.

⁸ Dynamic supply current is the incremental amount of supply current required for a 1 Mbps increase in signal data rate. See [Figure 6](#) through [Figure 8](#) for information on per-channel supply current for unloaded and loaded conditions. See the [Power Consumption](#) section for guidance on calculating the per-channel supply current for a given data rate.

SPECIFICATIONS

ELECTRICAL CHARACTERISTICS—MIXED 5 V/3 V, 125°C OPERATION

All voltages are relative to their respective ground. $4.5\text{ V} \leq V_{DD1} \leq 5.5\text{ V}$, $3.0\text{ V} \leq V_{DD2} \leq 3.6\text{ V}$; all minimum/maximum specifications apply over the entire recommended operation range, unless otherwise noted; all typical specifications are at $T_A = 25^\circ\text{C}$; $V_{DD1} = 5\text{ V}$, $V_{DD2} = 3.0\text{ V}$. These specifications apply to ADuM1300W and ADuM1301W automotive grade versions.

Table 6.

| Parameter | Symbol | Min | Typ | Max | Unit | Test Conditions/Comments |
|--|--|--|--|-------------------|---------------|---|
| DC SPECIFICATIONS | | | | | | |
| Input Supply Current per Channel, Quiescent | $I_{DD1(Q)}$ | | 0.50 | 0.53 | mA | |
| Output Supply Current per Channel, Quiescent | $I_{DDO(Q)}$ | | 0.11 | 0.15 | mA | |
| ADuM1300W, Total Supply Current, Three Channels ¹ | | | | | | |
| DC to 2 Mbps | | | | | | |
| V_{DD1} Supply Current | $I_{DD1(Q)}$ | | 1.6 | 2.5 | mA | DC to 1 MHz logic signal freq. |
| V_{DD2} Supply Current | $I_{DD2(Q)}$ | | 0.4 | 0.7 | mA | DC to 1 MHz logic signal freq. |
| 10 Mbps (TRWZ Grade Only) | | | | | | |
| V_{DD1} Supply Current | $I_{DD1(10)}$ | | 6.5 | 8.1 | mA | 5 MHz logic signal freq. |
| V_{DD2} Supply Current | $I_{DD2(10)}$ | | 1.1 | 1.6 | mA | 5 MHz logic signal freq. |
| ADuM1301W, Total Supply Current, Three Channels ¹ | | | | | | |
| DC to 2 Mbps | | | | | | |
| V_{DD1} Supply Current | $I_{DD1(Q)}$ | | 1.3 | 2.1 | mA | DC to 1 MHz logic signal freq. |
| V_{DD2} Supply Current | $I_{DD2(Q)}$ | | 0.6 | 0.9 | mA | DC to 1 MHz logic signal freq. |
| 10 Mbps (TRWZ Grade Only) | | | | | | |
| V_{DD1} Supply Current | $I_{DD1(10)}$ | | 5.0 | 6.2 | mA | 5 MHz logic signal freq. |
| V_{DD2} Supply Current | $I_{DD2(10)}$ | | 1.8 | 2.5 | mA | 5 MHz logic signal freq. |
| For All Models | | | | | | |
| Input Currents | $I_{IA}, I_{IB}, I_{IC}, I_{E1}, I_{E2}$ | -10 | +0.01 | +10 | μA | $0\text{ V} \leq V_{IA}, V_{IB}, V_{IC} \leq V_{DD1}$ or V_{DD2} , $0\text{ V} \leq V_{E1}, V_{E2} \leq V_{DD1}$ or V_{DD2} |
| Logic High Input Threshold | V_{IH}, V_{EH} | 2.0 | | | V | |
| Logic Low Input Threshold | V_{IL}, V_{EL} | | | 0.8 | V | |
| Logic High Output Voltages | $V_{OAH}, V_{OBH}, V_{OCH}$ | $V_{DD1}, V_{DD2} - 0.1$ $V_{DD1}, V_{DD2} - 0.4$ | V_{DD1}, V_{DD2} $V_{DD1}, V_{DD2} - 0.2$ | | V | $I_{OX} = -20\text{ }\mu\text{A}, V_{IX} = V_{IXH}$ $I_{OX} = -3.2\text{ mA}, V_{IX} = V_{IXH}$ |
| Logic Low Output Voltages | $V_{OAL}, V_{OBL}, V_{OCL}$ | | 0.0 0.04 0.2 | 0.1 0.1 0.4 | V | $I_{OX} = 20\text{ }\mu\text{A}, V_{IX} = V_{IXL}$ $I_{OX} = 400\text{ }\mu\text{A}, V_{IX} = V_{IXL}$ $I_{OX} = 3.2\text{ mA}, V_{IX} = V_{IXL}$ |
| SWITCHING SPECIFICATIONS | | | | | | |
| ADuM1300WSRWZ/ADuM1301WSRWZ | | | | | | |
| Minimum Pulse Width ² | PW | | | 1000 | ns | $C_L = 15\text{ pF}$, CMOS signal levels |
| Maximum Data Rate ³ | | 1 | | | Mbps | $C_L = 15\text{ pF}$, CMOS signal levels |
| Propagation Delay ⁴ | t_{PHL}, t_{PLH} | 50 | 70 | 100 | ns | $C_L = 15\text{ pF}$, CMOS signal levels |
| Pulse Width Distortion, $ t_{PLH} - t_{PHL} $ ⁴ | PWD | | | 40 | ns | $C_L = 15\text{ pF}$, CMOS signal levels |
| Propagation Delay Skew ⁵ | t_{PSK} | | | 50 | ns | $C_L = 15\text{ pF}$, CMOS signal levels |
| Channel-to-Channel Matching ⁶ | t_{PSKCD}/t_{PSKOD} | | | 50 | ns | $C_L = 15\text{ pF}$, CMOS signal levels |
| ADuM1300WTRWZ/ADuM1301WTRWZ | | | | | | |
| Minimum Pulse Width ² | PW | | | 100 | ns | $C_L = 15\text{ pF}$, CMOS signal levels |
| Maximum Data Rate ³ | | 10 | | | Mbps | $C_L = 15\text{ pF}$, CMOS signal levels |
| Propagation Delay ⁴ | t_{PHL}, t_{PLH} | 20 | 30 | 40 | ns | $C_L = 15\text{ pF}$, CMOS signal levels |
| Pulse Width Distortion, $ t_{PLH} - t_{PHL} $ ⁴ | PWD | | | 3 | ns | $C_L = 15\text{ pF}$, CMOS signal levels |
| Change vs. Temperature | | | 5 | | ps/°C | $C_L = 15\text{ pF}$, CMOS signal levels |

SPECIFICATIONS

Table 6. (Continued)

| Parameter | Symbol | Min | Typ | Max | Unit | Test Conditions/Comments |
|---|--------------------|-----|------|-----|-------------|---|
| Propagation Delay Skew ⁵ | t_{PSK} | | | 6 | ns | $C_L = 15$ pF, CMOS signal levels |
| Channel-to-Channel Matching, Codirectional Channels ⁶ | t_{PSKCD} | | | 3 | ns | $C_L = 15$ pF, CMOS signal levels |
| Channel-to-Channel Matching, Opposing-Directional Channels ⁶ | t_{PSKOD} | | | 22 | ns | $C_L = 15$ pF, CMOS signal levels |
| For All Models | | | | | | |
| Output Disable Propagation Delay (High/Low to High Impedance) | t_{PHZ}, t_{PLH} | | 6 | 8 | ns | $C_L = 15$ pF, CMOS signal levels |
| Output Enable Propagation Delay (High Impedance to High/Low) | t_{PZH}, t_{PZL} | | 6 | 8 | ns | $C_L = 15$ pF, CMOS signal levels |
| Output Rise/Fall Time (10% to 90%) | t_R/t_F | | 3.0 | | ns | $C_L = 15$ pF, CMOS signal levels |
| Common-Mode Transient Immunity at Logic High Output ⁷ | $ CM_H $ | 25 | 35 | | kV/ μ s | $V_{IX} = V_{DD1}/V_{DD2}$, $V_{CM} = 1000$ V, transient magnitude = 800 V |
| Common-Mode Transient Immunity at Logic Low Output ⁷ | $ CM_L $ | 25 | 35 | | kV/ μ s | $V_{IX} = 0$ V, $V_{CM} = 1000$ V, transient magnitude = 800 V |
| Refresh Rate | f_r | | 1.2 | | Mbps | |
| Input Dynamic Supply Current per Channel ⁸ | $I_{DDI(D)}$ | | 0.19 | | mA/Mbps | |
| Output Dynamic Supply Current per Channel ⁸ | $I_{DDO(D)}$ | | 0.03 | | mA/Mbps | |

- ¹ The supply current values are for all three channels combined when running at identical data rates. Output supply current values are specified with no output load present. The supply current associated with an individual channel operating at a given data rate may be calculated as described in the [Power Consumption](#) section. See [Figure 6](#) through [Figure 8](#) for information on per-channel supply current as a function of data rate for unloaded and loaded conditions. See [Figure 9](#) through [Figure 12](#) for total V_{DD1} and V_{DD2} supply currents as a function of data rate for ADuM1300W/ADuM1301W channel configurations.
- ² The minimum pulse width is the shortest pulse width at which the specified pulse width distortion is guaranteed.
- ³ The maximum data rate is the fastest data rate at which the specified pulse width distortion is guaranteed.
- ⁴ t_{PHL} propagation delay is measured from the 50% level of the falling edge of the V_{IX} signal to the 50% level of the falling edge of the V_{OX} signal. t_{PLH} propagation delay is measured from the 50% level of the rising edge of the V_{IX} signal to the 50% level of the rising edge of the V_{OX} signal.
- ⁵ t_{PSK} is the magnitude of the worst-case difference in t_{PHL} or t_{PLH} that is measured between units at the same operating temperature, supply voltages, and output load within the recommended operating conditions.
- ⁶ Codirectional channel-to-channel matching is the absolute value of the difference in propagation delays between any two channels with inputs on the same side of the isolation barrier. Opposing-directional channel-to-channel matching is the absolute value of the difference in propagation delays between any two channels with inputs on opposing sides of the isolation barrier.
- ⁷ CM_H is the maximum common-mode voltage slew rate that can be sustained while maintaining $V_O > 0.8 V_{DD2}$. CM_L is the maximum common-mode voltage slew rate that can be sustained while maintaining $V_O < 0.8$ V. The common-mode voltage slew rates apply to both rising and falling common-mode voltage edges. The transient magnitude is the range over which the common mode is slewed.
- ⁸ Dynamic supply current is the incremental amount of supply current required for a 1 Mbps increase in signal data rate. See [Figure 6](#) through [Figure 8](#) for information on per-channel supply current for unloaded and loaded conditions. See the [Power Consumption](#) section for guidance on calculating the per-channel supply current for a given data rate.

SPECIFICATIONS

ELECTRICAL CHARACTERISTICS—MIXED 3 V/5 V, 125°C OPERATION

All voltages are relative to their respective ground. $3.0\text{ V} \leq V_{DD1} \leq 3.6\text{ V}$, $4.5\text{ V} \leq V_{DD2} \leq 5.5\text{ V}$; all minimum/maximum specifications apply over the entire recommended operation range, unless otherwise noted; all typical specifications are at $T_A = 25^\circ\text{C}$; $V_{DD1} = 3.0\text{ V}$, $V_{DD2} = 5\text{ V}$. These apply to ADuM1300W and ADuM1301W automotive grade versions.

Table 7.

| Parameter | Symbol | Min | Typ | Max | Unit | Test Conditions/Comments |
|--|--|--|--|-------------------|---------------|---|
| DC SPECIFICATIONS | | | | | | |
| Input Supply Current per Channel, Quiescent | $I_{DD1(Q)}$ | | 0.26 | 0.31 | mA | |
| Output Supply Current per Channel, Quiescent | $I_{DDO(Q)}$ | | 0.19 | 0.24 | mA | |
| ADuM1300W, Total Supply Current, Three Channels ¹ | | | | | | |
| DC to 2 Mbps | | | | | | |
| V_{DD1} Supply Current | $I_{DD1(Q)}$ | | 0.9 | 1.7 | mA | DC to 1 MHz logic signal freq. |
| V_{DD2} Supply Current | $I_{DD2(Q)}$ | | 0.7 | 1.0 | mA | DC to 1 MHz logic signal freq. |
| 10 Mbps (TRWZ Grade Only) | | | | | | |
| V_{DD1} Supply Current | $I_{DD1(10)}$ | | 3.4 | 4.9 | mA | 5 MHz logic signal freq. |
| V_{DD2} Supply Current | $I_{DD2(10)}$ | | 1.9 | 2.5 | mA | 5 MHz logic signal freq. |
| ADuM1301W, Total Supply Current, Three Channels ¹ | | | | | | |
| DC to 2 Mbps | | | | | | |
| V_{DD1} Supply Current | $I_{DD1(Q)}$ | | 0.7 | 1.4 | mA | DC to 1 MHz logic signal freq. |
| V_{DD2} Supply Current | $I_{DD2(Q)}$ | | 1.0 | 1.4 | mA | DC to 1 MHz logic signal freq. |
| 10 Mbps (TRWZ Grade Only) | | | | | | |
| V_{DD1} Supply Current | $I_{DD1(10)}$ | | 2.6 | 3.7 | mA | 5 MHz logic signal freq. |
| V_{DD2} Supply Current | $I_{DD2(10)}$ | | 3.4 | 4.2 | mA | 5 MHz logic signal freq. |
| For All Models | | | | | | |
| Input Currents | $I_{IA}, I_{IB}, I_{IC}, I_{E1}, I_{E2}$ | -10 | +0.01 | +10 | μA | $0\text{ V} \leq V_{IA}, V_{IB}, V_{IC} \leq V_{DD1}$ or V_{DD2} , $0\text{ V} \leq V_{E1}, V_{E2} \leq V_{DD1}$ or V_{DD2} |
| Logic High Input Threshold | V_{IH}, V_{EH} | 1.6 | | | V | |
| Logic Low Input Threshold | V_{IL}, V_{EL} | | | 0.4 | V | |
| Logic High Output Voltages | $V_{OAH}, V_{OBH}, V_{OCH}$ | $V_{DD1}, V_{DD2} - 0.1$ $V_{DD1}, V_{DD2} - 0.4$ | V_{DD1}, V_{DD2} $V_{DD1}, V_{DD2} - 0.2$ | | V | $I_{OX} = -20\text{ }\mu\text{A}, V_{IX} = V_{IXH}$ $I_{OX} = -3.2\text{ mA}, V_{IX} = V_{IXH}$ |
| Logic Low Output Voltages | $V_{OAL}, V_{OBL}, V_{OCL}$ | | 0.0 0.04 0.2 | 0.1 0.1 0.4 | V | $I_{OX} = 20\text{ }\mu\text{A}, V_{IX} = V_{IXL}$ $I_{OX} = 400\text{ }\mu\text{A}, V_{IX} = V_{IXL}$ $I_{OX} = 3.2\text{ mA}, V_{IX} = V_{IXL}$ |
| SWITCHING SPECIFICATIONS | | | | | | |
| ADuM1300WSRWZ/ADuM1301WSRWZ | | | | | | |
| Minimum Pulse Width ² | PW | | | 1000 | ns | $C_L = 15\text{ pF}$, CMOS signal levels |
| Maximum Data Rate ³ | | 1 | | | Mbps | $C_L = 15\text{ pF}$, CMOS signal levels |
| Propagation Delay ⁴ | t_{PHL}, t_{PLH} | 50 | 70 | 100 | ns | $C_L = 15\text{ pF}$, CMOS signal levels |
| Pulse Width Distortion, $ t_{PLH} - t_{PHL} $ ⁴ | PWD | | | 40 | ns | $C_L = 15\text{ pF}$, CMOS signal levels |
| Propagation Delay Skew ⁵ | t_{PSK} | | | 50 | ns | $C_L = 15\text{ pF}$, CMOS signal levels |
| Channel-to-Channel Matching ⁶ | t_{PSKCD}/t_{PSKOD} | | | 50 | ns | $C_L = 15\text{ pF}$, CMOS signal levels |
| ADuM1300WTRWZ/ADuM1301WTRWZ | | | | | | |
| Minimum Pulse Width ² | PW | | | 100 | ns | $C_L = 15\text{ pF}$, CMOS signal levels |
| Maximum Data Rate ³ | | 10 | | | Mbps | $C_L = 15\text{ pF}$, CMOS signal levels |
| Propagation Delay ⁴ | t_{PHL}, t_{PLH} | 20 | 30 | 40 | ns | $C_L = 15\text{ pF}$, CMOS signal levels |
| Pulse Width Distortion, $ t_{PLH} - t_{PHL} $ ⁴ | PWD | | | 3 | ns | $C_L = 15\text{ pF}$, CMOS signal levels |
| Change vs. Temperature | | | 5 | | ps/°C | $C_L = 15\text{ pF}$, CMOS signal levels |

SPECIFICATIONS

Table 7. (Continued)

| Parameter | Symbol | Min | Typ | Max | Unit | Test Conditions/Comments |
|---|--------------------|-----|------|-----|-------------|---|
| Propagation Delay Skew ⁵ | t_{PSK} | | | 6 | ns | $C_L = 15$ pF, CMOS signal levels |
| Channel-to-Channel Matching, Codirectional Channels ⁶ | t_{PSKCD} | | | 3 | ns | $C_L = 15$ pF, CMOS signal levels |
| Channel-to-Channel Matching, Opposing-Directional Channels ⁶ | t_{PSKOD} | | | 22 | ns | $C_L = 15$ pF, CMOS signal levels |
| For All Models | | | | | | |
| Output Disable Propagation Delay (High/Low to High Impedance) | t_{PHZ}, t_{PLH} | | 6 | 8 | ns | $C_L = 15$ pF, CMOS signal levels |
| Output Enable Propagation Delay (High Impedance to High/Low) | t_{PZH}, t_{PZL} | | 6 | 8 | ns | $C_L = 15$ pF, CMOS signal levels |
| Output Rise/Fall Time (10% to 90%) | t_R/t_F | | | | | $C_L = 15$ pF, CMOS signal levels |
| 5 V/3 V Operation | | | 3.0 | | ns | |
| 3 V/5 V Operation | | | 2.5 | | ns | |
| Common-Mode Transient Immunity at Logic High Output ⁷ | $ CM_H $ | 25 | 35 | | kV/ μ s | $V_{IX} = V_{DD1}/V_{DD2}$, $V_{CM} = 1000$ V, transient magnitude = 800 V |
| Common-Mode Transient Immunity at Logic Low Output ⁷ | $ CM_L $ | 25 | 35 | | kV/ μ s | $V_{IX} = 0$ V, $V_{CM} = 1000$ V, transient magnitude = 800 V |
| Refresh Rate | f_r | | 1.1 | | Mbps | |
| Input Dynamic Supply Current per Channel ⁸ | $I_{DDI} (D)$ | | 0.10 | | mA/Mbps | |
| Output Dynamic Supply Current per Channel ⁸ | $I_{DDO} (D)$ | | 0.05 | | mA/Mbps | |

¹ The supply current values are for all three channels combined when running at identical data rates. Output supply current values are specified with no output load present. The supply current associated with an individual channel operating at a given data rate may be calculated as described in the Power Consumption section. See Figure 6 through Figure 8 for information on per-channel supply current as a function of data rate for unloaded and loaded conditions. See Figure 9 through Figure 12 for total V_{DD1} and V_{DD2} supply currents as a function of data rate for ADuM1300W/ADuM1301W channel configurations.

² The minimum pulse width is the shortest pulse width at which the specified pulse width distortion is guaranteed.

³ The maximum data rate is the fastest data rate at which the specified pulse width distortion is guaranteed.

⁴ t_{PHL} propagation delay is measured from the 50% level of the falling edge of the V_{IX} signal to the 50% level of the falling edge of the V_{OX} signal. t_{PLH} propagation delay is measured from the 50% level of the rising edge of the V_{IX} signal to the 50% level of the rising edge of the V_{OX} signal.

⁵ t_{PSK} is the magnitude of the worst-case difference in t_{PHL} or t_{PLH} that is measured between units at the same operating temperature, supply voltages, and output load within the recommended operating conditions.

⁶ Codirectional channel-to-channel matching is the absolute value of the difference in propagation delays between any two channels with inputs on the same side of the isolation barrier. Opposing-directional channel-to-channel matching is the absolute value of the difference in propagation delays between any two channels with inputs on opposing sides of the isolation barrier.

⁷ CM_H is the maximum common-mode voltage slew rate that can be sustained while maintaining $V_O > 0.8 V_{DD2}$. CM_L is the maximum common-mode voltage slew rate that can be sustained while maintaining $V_O < 0.8$ V. The common-mode voltage slew rates apply to both rising and falling common-mode voltage edges. The transient magnitude is the range over which the common mode is slewed.

⁸ Dynamic supply current is the incremental amount of supply current required for a 1 Mbps increase in signal data rate. See Figure 6 through Figure 8 for information on per-channel supply current for unloaded and loaded conditions. See the Power Consumption section for guidance on calculating the per-channel supply current for a given data rate.

SPECIFICATIONS

PACKAGE CHARACTERISTICS

Table 8.

| Parameter | Symbol | Min | Typ | Max | Unit | Test Conditions/Comments |
|--|------------------|-----|------------------|-----|------|---|
| Resistance (Input-to-Output) ¹ | R _{I-O} | | 10 ¹² | | Ω | |
| Capacitance (Input-to-Output) ¹ | C _{I-O} | | 1.7 | | pF | f = 1 MHz |
| Input Capacitance ² | C _I | | 4.0 | | pF | |
| IC Junction-to-Case Thermal Resistance, Side 1 | θ _{JCI} | | 33 | | °C/W | Thermocouple located at center of package underside |
| IC Junction-to-Case Thermal Resistance, Side 2 | θ _{JCO} | | 28 | | °C/W | |

¹ Device is considered a 2-terminal device; Pin 1, Pin 2, Pin 3, Pin 4, Pin 5, Pin 6, Pin 7, and Pin 8 are shorted together and Pin 9, Pin 10, Pin 11, Pin 12, Pin 13, Pin 14, Pin 15, and Pin 16 are shorted together.

² Input capacitance is from any input data pin to ground.

REGULATORY INFORMATION

The ADuM1300/ADuM1301 certification approvals are listed in Table 9. Refer to the [Insulation Lifetime](#) section for details regarding recommended insulation levels.

Table 9.

| UL | CSA | CQC | VDE | TÜV |
|--|---|--|--|---|
| UL 1577 ¹ | IEC/EN/CSA 62368-1 Basic Insulation, 600 V _{rms} Reinforced Insulation, 150 V _{rms} | CQC GB4943.1 | DIN EN IEC 60747-17 (VDE 0884-17) ² | EN 60950-1 |
| Single Protection, 2500 V _{rms} | IEC/CSA 61010-1 Basic Insulation (1 MOPP), 490 V _{rms} Reinforced insulation (2 MOPP), 150 V _{rms} IEC/CSA 61010-1 Reinforced insulation, 150 V _{rms} | Basic Insulation, 415 V _{rms} | Reinforced insulation, 560 V _{peak} | Basic Insulation, 770 V _{rms} Reinforced Insulation, 385 V _{rms} |
| File E214100 | Master Contract 205078 | Certificate No. CQC14001114900 | Certificate No. 40011599 | Certificate No. U8V 17 04 56232 019 |

¹ In accordance with UL 1577, each ADuM1300/ADuM1301 is proof tested by applying an insulation test voltage ≥3000 V_{rms} for 1 sec (current leakage detection limit = 5 μA).

² In accordance with DIN EN IEC 60747-17 (VDE 0884-17), each ADuM1300/ADuM1301 is proof tested by applying an insulation test voltage ≥1050 V_{peak} for 1 sec (partial discharge detection limit = 5 pC). The * marking branded on the component designates DIN EN IEC 60747-17 (VDE 0884-17) approval.

INSULATION AND SAFETY-RELATED SPECIFICATIONS

Table 10.

| Parameter | Symbol | Value | Unit | Conditions |
|---|--------|-------|------------------|--|
| Rated Dielectric Insulation Voltage | | 2500 | V _{rms} | 1-minute duration |
| Minimum External Air Gap (Clearance) ^{1, 2} | L(I01) | 7.8 | mm | Measured from input terminals to output terminals, shortest distance through air |
| Minimum External Tracking (Creepage) ¹ | L(I02) | 7.8 | mm | Measured from input terminals to output terminals, shortest distance path along body |
| Minimum Internal Gap (Internal Clearance) | | 18 | μm | Insulation distance through insulation |
| Tracking Resistance (Comparative Tracking Index) ³ | CTI | >400 | V | DIN IEC 112/VDE 0303 Part 1 |
| Isolation Group | | II | | Material Group (DIN VDE 0110, 1/89, Table 1) |

¹ In accordance with IEC 62368-1/IEC 60601-1 guidelines for the measurement of creepage and clearance distances for a pollution degree of 2 and altitudes ≤2000 m.

SPECIFICATIONS

- ² Consideration must be given to pad layout to ensure the minimum required distance for clearance is maintained.
- ³ CTI rating for the ADuM1300/ADuM1301 is >400 V and a Material Group II isolation group.

DIN EN IEC 60747-17 (VDE 0884-17) INSULATION CHARACTERISTICS

These isolators are suitable for reinforced electrical isolation only within the safety limit data. Maintenance of the safety data is ensured by protective circuits. The asterisk (*) marking on packages denotes DIN EN IEC 60747-17 (VDE 0884-17) approval.

Table 11.

| Description | Conditions | Symbol | Characteristic | Unit |
|--|--|-------------------|------------------|-------------------|
| Overvoltage Category per IEC 60664-1 | | | I to IV | |
| For Rated Mains Voltage ≤ 150 V _{rms} | | | I to III | |
| For Rated Mains Voltage ≤ 300 V _{rms} | | | I to II | |
| For Rated Mains Voltage ≤ 400 V _{rms} | | | | |
| Climatic Classification | | | 40/105/21 | |
| Pollution Degree per DIN VDE 0110, Table 1 | | | 2 | |
| Maximum Repetitive Isolation Voltage | | V _{IORM} | 560 | V _{peak} |
| Maximum Working Insulation Voltage | | V _{IOWM} | 396 | V _{rms} |
| Input-to-Output Test Voltage, Method B1 | V _{IORM} × 1.875 = V _{PR} , 100% production test, t _m = 1 sec, partial discharge < 5 pC | V _{IORM} | 1050 | V _{peak} |
| Input-to-Output Test Voltage, Method A | | V _{IORM} | | |
| After Environmental Tests Subgroup 1 | V _{IORM} × 1.6 = V _{PR} , t _m = 60 sec, partial discharge < 5 pC | | 896 | V _{peak} |
| After Input and/or Safety Test Subgroup 2 and Subgroup 3 | V _{IORM} × 1.2 = V _{PR} , t _m = 60 sec, partial discharge < 5 pC | | 672 | V _{peak} |
| Maximum Transient Isolation Voltage | Transient overvoltage, t _{TR} = 10 seconds | V _{IOTM} | 4000 | V _{peak} |
| Maximum Impulse Voltage | Tested in air, 1.2 μs/50 μs waveform per IEC 61000-4-5 | V _{IMP} | 4000 | V _{peak} |
| Maximum Surge Isolation Voltage | Tested in oil, 1.2 μs/50 μs waveform per IEC 61000-4-5, | V _{IOSM} | | V _{peak} |
| Reinforced | V _{TEST} = V _{IOSM} × 1.3 OR ≥ 10kV | | 10000 | |
| Safety-Limiting Values | Maximum value allowed in the event of a failure (see Figure 3) | | | |
| Case Temperature | | T _S | 150 | °C |
| Side 1 Current | | I _{S1} | 265 | mA |
| Side 2 Current | | I _{S2} | 335 | mA |
| Insulation Resistance at T _S | V _{IO} = 500 V | R _S | >10 ⁹ | Ω |

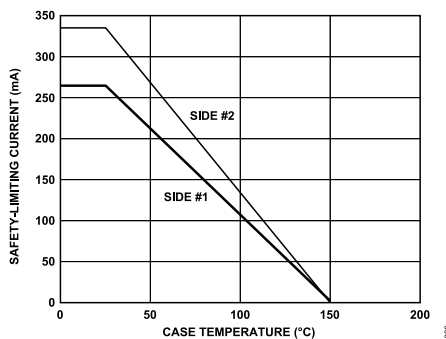

Figure 3. Thermal Derating Curve, Dependence of Safety-Limiting Values with Case Temperature per DIN EN IEC 60747-17 (VDE 0884-17)

SPECIFICATIONS**RECOMMENDED OPERATING CONDITIONS****Table 12.**

| Parameter | Rating |
|---|-----------------|
| Operating Temperature (T_A) ¹ | -40°C to +105°C |
| Operating Temperature (T_A) ² | -40°C to +125°C |
| Supply Voltages (V_{DD1} , V_{DD2}) ^{1, 3} | 2.7 V to 5.5 V |
| Supply Voltages (V_{DD1} , V_{DD2}) ^{2, 3} | 3.0 V to 5.5 V |
| Input Signal Rise and Fall Times | 1.0 ms |

¹ Does not apply to ADuM1300W and ADuM1301W automotive grade versions.

² Applies to ADuM1300W and ADuM1301W automotive grade versions.

³ All voltages are relative to their respective ground. See the [DC Correctness and Magnetic Field Immunity](#) section for information on immunity to external magnetic fields.

ABSOLUTE MAXIMUM RATINGS

Ambient temperature = 25°C, unless otherwise noted.

Table 13.

| Parameter | Rating |
|--|-----------------------------|
| Storage Temperature (T_{ST}) | -65°C to +150°C |
| Ambient Operating Temperature (T_A) ¹ | -40°C to +105°C |
| Ambient Operating Temperature (T_A) ² | -40°C to +125°C |
| Supply Voltages (V_{DD1} , V_{DD2}) ³ | -0.5 V to +7.0 V |
| Input Voltage (V_{IA} , V_{IB} , V_{IC} , V_{E1} , V_{E2}) ^{3, 4} | -0.5 V to $V_{DDI} + 0.5$ V |
| Output Voltage (V_{OA} , V_{OB} , V_{OC}) ^{3, 4} | -0.5 V to $V_{DDO} + 0.5$ V |
| Average Output Current per Pin ⁵ | |
| Side 1 (I_{O1}) | -23 mA to +23 mA |
| Side 2 (I_{O2}) | -30 mA to +30 mA |
| Common-Mode Transients ⁶ | -100 kV/μs to +100 kV/μs |

¹ Does not apply to ADuM1300W and ADuM1301W automotive grade versions.

² Applies to ADuM1300W and ADuM1301W automotive grade versions.

³ All voltages are relative to their respective ground.

⁴ V_{DDI} and V_{DDO} refer to the supply voltages on the input and output sides of a given channel, respectively. See the [Printed Circuit Board \(PCB\) Layout](#) section.

⁵ See [Figure 3](#) for maximum rated current values for various temperatures.

⁶ This refers to common-mode transients across the insulation barrier. Common-mode transients exceeding the Absolute Maximum Ratings may cause latch-up or permanent damage.

Stresses at or above those listed under Absolute Maximum Ratings may cause permanent damage to the product. This is a stress rating only; functional operation of the product at these or any other conditions above those indicated in the operational section of this specification is not implied. Operation beyond the maximum operating conditions for extended periods may affect product reliability.

ESD CAUTION



ESD (electrostatic discharge) sensitive device. Charged devices and circuit boards can discharge without detection. Although this product features patented or proprietary protection circuitry, damage may occur on devices subjected to high energy ESD. Therefore, proper ESD precautions should be taken to avoid performance degradation or loss of functionality.

PIN CONFIGURATIONS AND FUNCTION DESCRIPTIONS

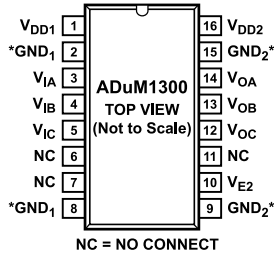

*PIN 2 AND PIN 8 ARE INTERNALLY CONNECTED, AND CONNECTING BOTH TO GND₁ IS RECOMMENDED. PIN 9 AND PIN 15 ARE INTERNALLY CONNECTED, AND CONNECTING BOTH TO GND₂ IS RECOMMENDED.

004

Figure 4. ADuM1300 Pin Configuration

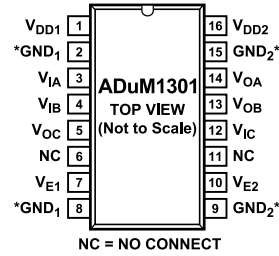

*PIN 2 AND PIN 8 ARE INTERNALLY CONNECTED, AND CONNECTING BOTH TO GND₁ IS RECOMMENDED. PIN 9 AND PIN 15 ARE INTERNALLY CONNECTED, AND CONNECTING BOTH TO GND₂ IS RECOMMENDED.

005

Figure 5. ADuM1301 Pin Configuration

Table 14. ADuM1300 Pin Function Descriptions

| Pin No. | Mnemonic | Description |
|---------|------------------|--|
| 1 | V _{DD1} | Supply Voltage for Isolator Side 1. |
| 2 | GND ₁ | Ground 1. Ground reference for Isolator Side 1. |
| 3 | V _{IA} | Logic Input A. |
| 4 | V _{IB} | Logic Input B. |
| 5 | V _{IC} | Logic Input C. |
| 6 | NC | No Connect. |
| 7 | NC | No Connect. |
| 8 | GND ₁ | Ground 1. Ground reference for Isolator Side 1. |
| 9 | GND ₂ | Ground 2. Ground reference for Isolator Side 2. |
| 10 | V _{E2} | Output Enable 2. Active high logic input. V _{OA} , V _{OB} , and V _{OC} outputs are enabled when V _{E2} is high or disconnected. V _{OA} , V _{OB} , and V _{OC} outputs are disabled when V _{E2} is low. In noisy environments, connecting V _{E2} to an external logic high or low is recommended. |
| 11 | NC | No Connect. |
| 12 | V _{OC} | Logic Output C. |
| 13 | V _{OB} | Logic Output B. |
| 14 | V _{OA} | Logic Output A. |
| 15 | GND ₂ | Ground 2. Ground reference for Isolator Side 2. |
| 16 | V _{DD2} | Supply Voltage for Isolator Side 2. |

Table 15. ADuM1301 Pin Function Descriptions

| Pin No. | Mnemonic | Description |
|---------|------------------|--|
| 1 | V _{DD1} | Supply Voltage for Isolator Side 1. |
| 2 | GND ₁ | Ground 1. Ground reference for Isolator Side 1. |
| 3 | V _{IA} | Logic Input A. |
| 4 | V _{IB} | Logic Input B. |
| 5 | V _{OC} | Logic Output C. |
| 6 | NC | No Connect. |
| 7 | V _{E1} | Output Enable 1. Active high logic input. V _{OC} output is enabled when V _{E1} is high or disconnected. V _{OC} output is disabled when V _{E1} is low. In noisy environments, connecting V _{E1} to an external logic high or low is recommended. |
| 8 | GND ₁ | Ground 1. Ground reference for Isolator Side 1. |
| 9 | GND ₂ | Ground 2. Ground reference for Isolator Side 2. |
| 10 | V _{E2} | Output Enable 2. Active high logic input. V _{OA} and V _{OB} outputs are enabled when V _{E2} is high or disconnected. V _{OA} and V _{OB} outputs are disabled when V _{E2} is low. In noisy environments, connecting V _{E2} to an external logic high or low is recommended. |
| 11 | NC | No Connect. |
| 12 | V _{IC} | Logic Input C. |
| 13 | V _{OB} | Logic Output B. |
| 14 | V _{OA} | Logic Output A. |
| 15 | GND ₂ | Ground 2. Ground reference for Isolator Side 2. |

PIN CONFIGURATIONS AND FUNCTION DESCRIPTIONS**Table 15. ADuM1301 Pin Function Descriptions (Continued)**

| Pin No. | Mnemonic | Description |
|---------|------------------|-------------------------------------|
| 16 | V _{DD2} | Supply Voltage for Isolator Side 2. |

TYPICAL PERFORMANCE CHARACTERISTICS

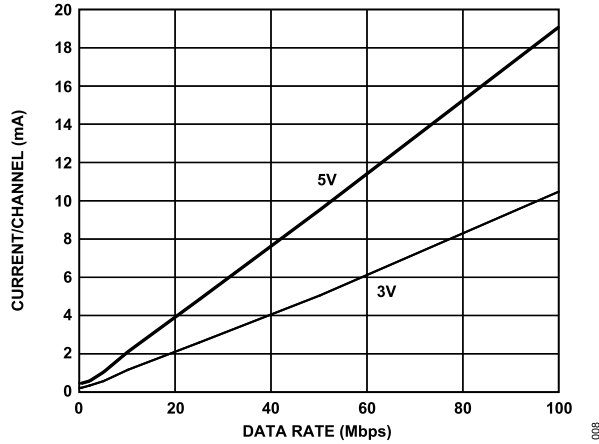

Figure 6. Typical Input Supply Current per Channel vs. Data Rate for 5 V and 3 V Operation

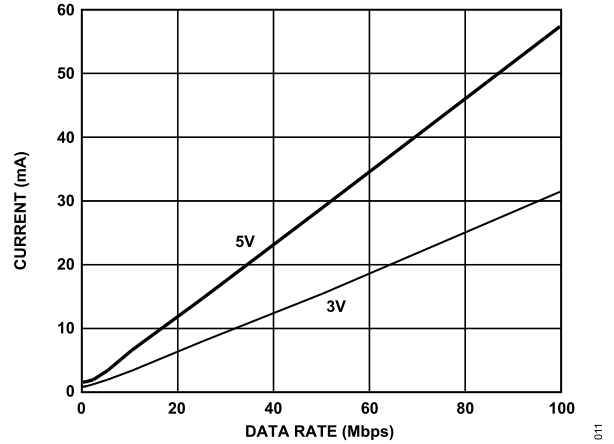

Figure 9. Typical ADuM1300 V_{DD1} Supply Current vs. Data Rate for 5 V and 3 V Operation

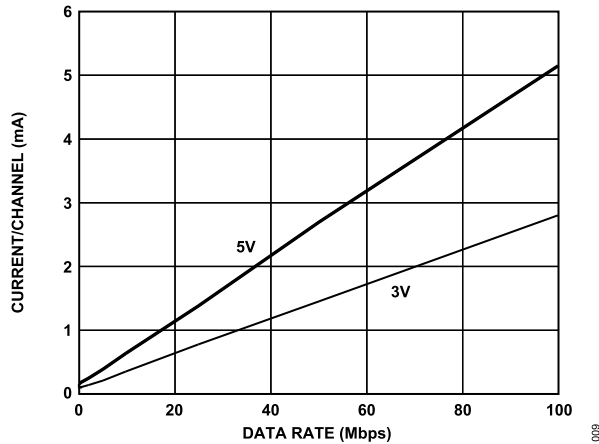

Figure 7. Typical Output Supply Current per Channel vs. Data Rate for 5 V and 3 V Operation (No Output Load)

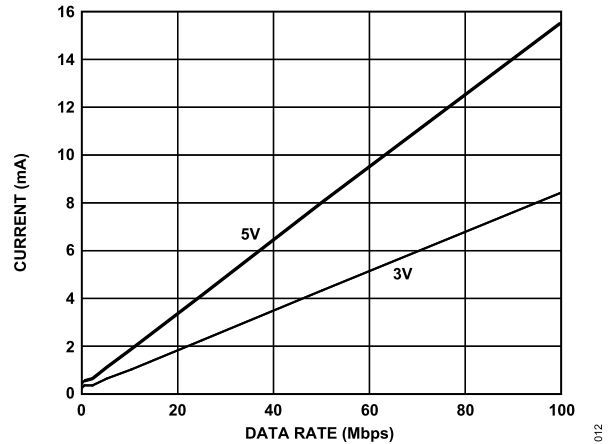

Figure 10. Typical ADuM1300 V_{DD2} Supply Current vs. Data Rate for 5 V and 3 V Operation

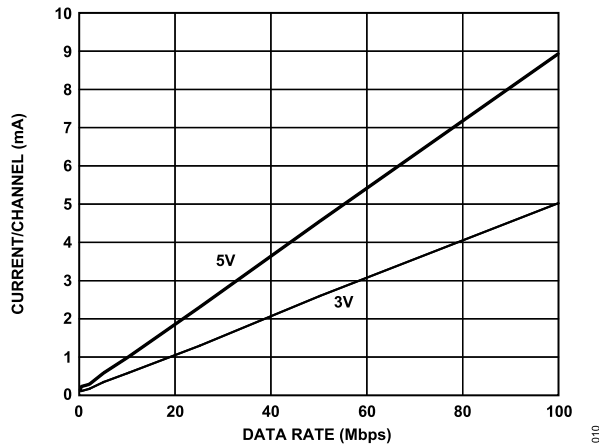

Figure 8. Typical Output Supply Current per Channel vs. Data Rate for 5 V and 3 V Operation (15 pF Output Load)

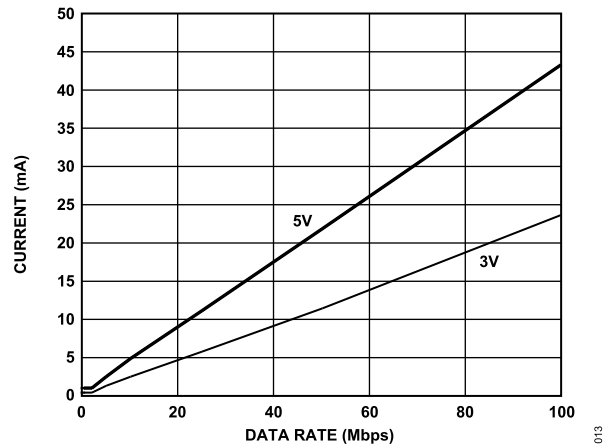

Figure 11. Typical ADuM1301 V_{DD1} Supply Current vs. Data Rate for 5 V and 3 V Operation

TYPICAL PERFORMANCE CHARACTERISTICS

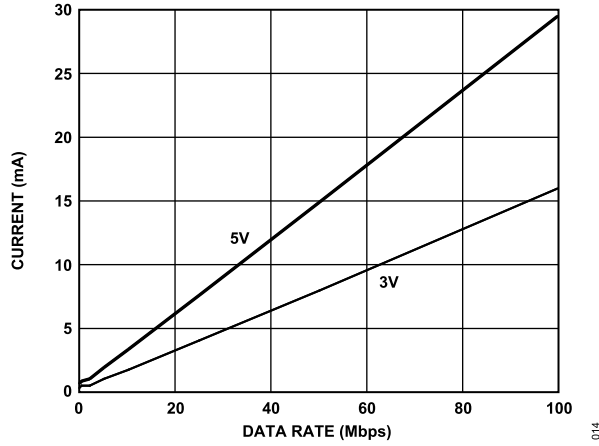

Figure 12. Typical ADuM1301 V_{DD2} Supply Current vs. Data Rate for 5 V and 3 V Operation

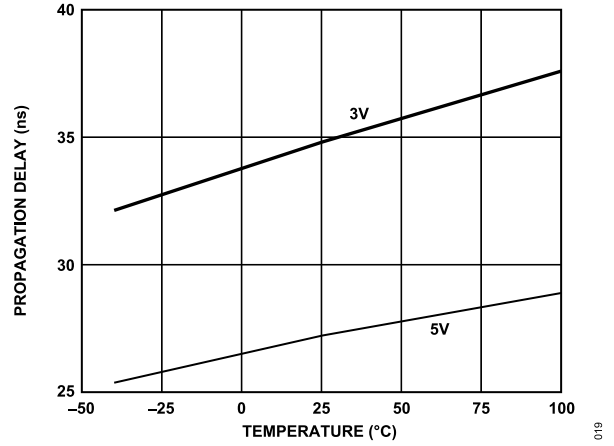

Figure 13. Propagation Delay vs. Temperature, C Grade

TRUTH TABLE

Table 16. Truth Table (Positive Logic)

| V_{Ix} Input ¹ | V_{Ex} Input ^{1,2} | V_{DD1} State ¹ | V_{DD0} State ¹ | V_{Ox} Output ¹ | Notes |
|-----------------------------|-------------------------------|------------------------------|------------------------------|------------------------------|---|
| H | H or NC | Powered | Powered | H | |
| L | H or NC | Powered | Powered | L | |
| X | L | Powered | Powered | Z | |
| X | H or NC | Unpowered | Powered | H | Outputs return to the input state within 1 μ s of V_{DDI} power restoration. |
| X | L | Unpowered | Powered | Z | |
| X | X | Powered | Unpowered | Indeterminate | Outputs return to the input state within 1 μ s of V_{DDO} power restoration if the V_{Ex} state is H or NC. Outputs return to a high impedance state within 8 ns of V_{DDO} power restoration if the V_{Ex} state is L. |

¹ V_{Ix} and V_{Ox} refer to the input and output signals of a given channel (A, B, or C). V_{Ex} refers to the output enable signal on the same side as the V_{Ox} outputs. V_{DDI} and V_{DDO} refer to the supply voltages on the input and output sides of the given channel, respectively.

² In noisy environments, connecting V_{Ex} to an external logic high or low is recommended.

APPLICATIONS INFORMATION

PRINTED CIRCUIT BOARD (PCB) LAYOUT

The ADuM1300/ADuM1301 digital isolator requires no external interface circuitry for the logic interfaces. Power supply bypassing is strongly recommended at the input and output supply pins (see [Figure 14](#)). Bypass capacitors are most conveniently connected between Pin 1 and Pin 2 for V_{DD1} and between Pin 15 and Pin 16 for V_{DD2} . The capacitor value should be between 0.01 μF and 0.1 μF . The total lead length between both ends of the capacitor and the input power supply pin should not exceed 20 mm. Bypassing between Pin 1 and Pin 8 and between Pin 9 and Pin 16 should also be considered unless the ground pair on each package side is connected close to the package.

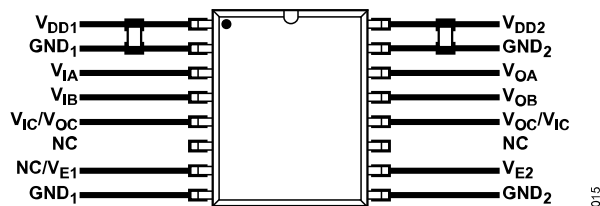

Figure 14. Recommended Printed Circuit Board Layout

In applications involving high common-mode transients, take care to ensure that board coupling across the isolation barrier is minimized. Furthermore, the board layout should be designed such that any coupling that does occur equally affects all pins on a given component side. Failure to ensure this could cause voltage differentials between pins exceeding the absolute maximum ratings of the device, thereby leading to latch-up or permanent damage.

See the [AN-1109 Application Note](#) for board layout guidelines.

PROPAGATION DELAY-RELATED PARAMETERS

Propagation delay is a parameter that describes the time it takes a logic signal to propagate through a component. The propagation delay to a logic low output may differ from the propagation delay to a logic high output.

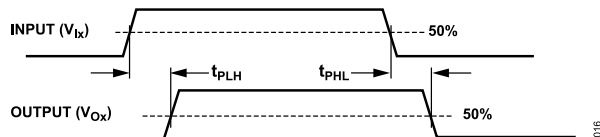

Figure 15. Propagation Delay Parameters

Pulse width distortion is the maximum difference between these two propagation delay values and is an indication of how accurately the timing of the input signal is preserved.

Channel-to-channel matching refers to the maximum amount that the propagation delay differs between channels within a single ADuM1300/ADuM1301 component.

Propagation delay skew refers to the maximum amount that the propagation delay differs between multiple ADuM1300/ADuM1301 components operating under the same conditions.

DC CORRECTNESS AND MAGNETIC FIELD IMMUNITY

Positive and negative logic transitions at the isolator input cause narrow (approximately 1 ns) pulses to be sent to the decoder via the transformer. The decoder is bistable and is therefore either set or reset by the pulses, indicating input logic transitions. In the absence of logic transitions at the input for more than approximately 1 μs , a periodic set of refresh pulses indicative of the correct input state are sent to ensure dc correctness at the output. If the decoder receives no internal pulses for more than about 5 μs , the input side is assumed to be unpowered or nonfunctional, in which case the isolator output is forced to a default state (see [Table 16](#)) by the watchdog timer circuit.

The ADuM1300/ADuM1301 is extremely immune to external magnetic fields. The limitation on the magnetic field immunity of the ADuM1300/ADuM1301 is set by the condition in which induced voltage in the receiving coil of the transformer is sufficiently large enough to either falsely set or reset the decoder. The following analysis defines the conditions under which this may occur. The 3 V operating condition of the ADuM1300/ADuM1301 is examined because it represents the most susceptible mode of operation.

The pulses at the transformer output have an amplitude greater than 1.0 V. The decoder has a sensing threshold at about 0.5 V, thus establishing a 0.5 V margin in which induced voltages can be tolerated. The voltage induced across the receiving coil is given by

$$V = (-d\beta/dt) \sum r_n^2; n = 1, 2, \dots, N$$

where:

β is magnetic flux density (gauss).

N is the number of turns in the receiving coil.

r_n is the radius of the n^{th} turn in the receiving coil (cm).

Given the geometry of the receiving coil in the ADuM1300/ADuM1301 and an imposed requirement that the induced voltage be 50% at most of the 0.5 V margin at the decoder, a maximum allowable magnetic field is calculated as shown in [Figure 16](#).

APPLICATIONS INFORMATION

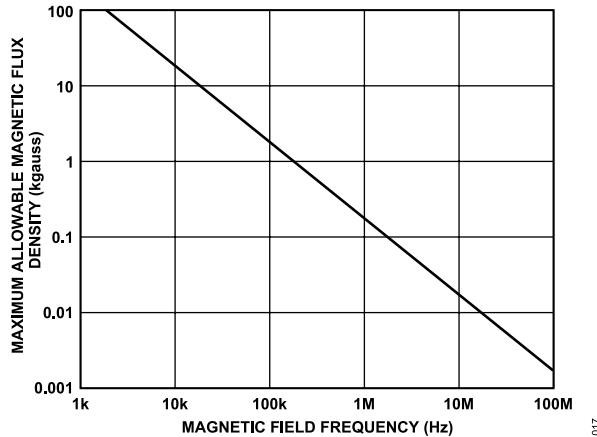

Figure 16. Maximum Allowable External Magnetic Flux Density

For example, at a magnetic field frequency of 1 MHz, the maximum allowable magnetic field of 0.2 kgauss induces a voltage of 0.25 V at the receiving coil. This is about 50% of the sensing threshold and does not cause a faulty output transition. Similarly, if such an event occurs during a transmitted pulse (and has the worst-case polarity), it reduces the received pulse from >1.0 V to 0.75 V—still well above the 0.5 V sensing threshold of the decoder.

The preceding magnetic flux density values correspond to specific current magnitudes at given distances from the ADuM1300/ADuM1301 transformers. Figure 17 shows these allowable current magnitudes as a function of frequency for selected distances. The ADuM1300/ADuM1301 is extremely immune and can be affected only by extremely large currents operated at a high frequency very close to the component. For the 1 MHz example noted, one would have to place a 0.5 kA current 5 mm away from the ADuM1300/ADuM1301 to affect the operation of the component.

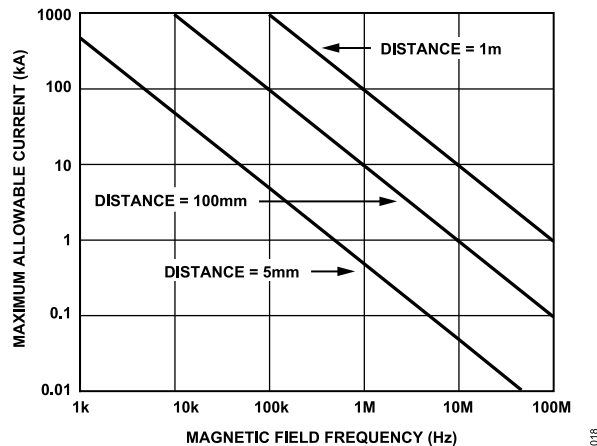

Figure 17. Maximum Allowable Current for Various Current-to-ADuM1300/ADuM1301 Spacings

Note that at combinations of strong magnetic field and high frequency, any loops formed by printed circuit board traces could induce error voltages sufficiently large enough to trigger the thresh-

olds of succeeding circuitry. Take care in the layout of such traces to avoid this possibility.

POWER CONSUMPTION

The supply current at a given channel of the ADuM1300/ADuM1301 isolator is a function of the supply voltage, the data rate of the channel, and the output load of the channel.

For each input channel, the supply current is given by

$$I_{DDI} = I_{DDI(Q)} \quad f \leq 0.5 f_r$$

$$I_{DDI} = I_{DDI(D)} \times (2f - f_r) + I_{DDI(Q)} \quad f > 0.5 f_r$$

For each output channel, the supply current is given by

$$I_{DDO} = I_{DDO(Q)} \quad f \leq 0.5 f_r$$

$$I_{DDO} = (I_{DDO(D)} + (0.5 \times 10^{-3}) \times C_L \times V_{DDO}) \times (2f - f_r) + I_{DDO(Q)} \quad f > 0.5 f_r$$

where:

- $I_{DDI(D)}$, $I_{DDO(D)}$ are the input and output dynamic supply currents per channel (mA/Mbps).
- C_L is the output load capacitance (pF).
- V_{DDO} is the output supply voltage (V).
- f is the input logic signal frequency (MHz); it is half of the input data rate expressed in units of Mbps.
- f_r is the input stage refresh rate (Mbps).
- $I_{DDI(Q)}$, $I_{DDO(Q)}$ are the specified input and output quiescent supply currents (mA).

To calculate the total V_{DD1} and V_{DD2} supply current, the supply currents for each input and output channel corresponding to V_{DD1} and V_{DD2} are calculated and totaled. Figure 6 and Figure 7 provide per-channel supply currents as a function of data rate for an unloaded output condition. Figure 8 provides per-channel supply current as a function of data rate for a 15 pF output condition. Figure 9 through Figure 12 provide total V_{DD1} and V_{DD2} supply current as a function of data rate for ADuM1300/ADuM1301 channel configurations.

INSULATION LIFETIME

All insulation structures eventually break down when subjected to voltage stress over a sufficiently long period. The rate of insulation degradation is dependent on the characteristics of the voltage waveform applied across the insulation as well as on the materials and material interfaces.

The two types of insulation degradation of primary interest are breakdown along surfaces exposed to the air and insulation wear out. Surface breakdown is the phenomenon of surface tracking and the primary determinant of surface creepage requirements in system level standards. Insulation wear out is the phenomenon where charge injection or displacement currents inside the insulation material cause long-term insulation degradation.

OUTLINE DIMENSIONS

| Package Drawing (Option) | Package Type | Package Description |
|--------------------------|--------------|--|
| RW-16 | SOIC (Wide) | 16-Lead Standard Small Outline Package Wide Body |

For the latest package outline information and land patterns (footprints), go to [Package Index](#).

Updated: May 02, 2023

ORDERING GUIDE

| Model ^{1, 2, 3} | Temperature Range | Package Description | Packing Quantity | Package Option ⁴ |
|--------------------------|-------------------|---------------------|------------------|-----------------------------|
| ADUM1300ARW | -40°C to +105°C | 16-Lead SOIC Wide | | RW-16 |
| ADUM1300ARW-RL | -40°C to +105°C | 16-Lead SOIC Wide | Reel, 1000 | RW-16 |
| ADUM1300ARWZ | -40°C to +105°C | 16-Lead SOIC Wide | | RW-16 |
| ADUM1300ARWZ-RL | -40°C to +105°C | 16-Lead SOIC Wide | Reel, 1000 | RW-16 |
| ADUM1300BRWZ | -40°C to +105°C | 16-Lead SOIC Wide | | RW-16 |
| ADUM1300BRWZ-RL | -40°C to +105°C | 16-Lead SOIC Wide | Reel, 1000 | RW-16 |
| ADUM1300CRWZ | -40°C to +105°C | 16-Lead SOIC Wide | | RW-16 |
| ADUM1300CRWZ-RL | -40°C to +105°C | 16-Lead SOIC Wide | Reel, 1000 | RW-16 |
| ADUM1300WSRWZ | -40°C to +125°C | 16-Lead SOIC Wide | | RW-16 |
| ADUM1300WSRWZ-RL | -40°C to +125°C | 16-Lead SOIC Wide | Reel, 1000 | RW-16 |
| ADUM1300WTRWZ | -40°C to +125°C | 16-Lead SOIC Wide | | RW-16 |
| ADUM1300WTRWZ-RL | -40°C to +125°C | 16-Lead SOIC Wide | Reel, 1000 | RW-16 |
| ADUM1301ARW | -40°C to +105°C | 16-Lead SOIC Wide | | RW-16 |
| ADUM1301ARW-RL | -40°C to +105°C | 16-Lead SOIC Wide | Reel, 1000 | RW-16 |
| ADUM1301ARWZ | -40°C to +105°C | 16-Lead SOIC Wide | | RW-16 |
| ADUM1301ARWZ-RL | -40°C to +105°C | 16-Lead SOIC Wide | Reel, 1000 | RW-16 |
| ADUM1301BRW | -40°C to +105°C | 16-Lead SOIC Wide | | RW-16 |
| ADUM1301BRW-RL | -40°C to +105°C | 16-Lead SOIC Wide | Reel, 1000 | RW-16 |
| ADUM1301BRWZ | -40°C to +105°C | 16-Lead SOIC Wide | | RW-16 |
| ADUM1301BRWZ-RL | -40°C to +105°C | 16-Lead SOIC Wide | Reel, 1000 | RW-16 |
| ADUM1301CRW | -40°C to +105°C | 16-Lead SOIC Wide | | RW-16 |
| ADUM1301CRWZ | -40°C to +105°C | 16-Lead SOIC Wide | | RW-16 |
| ADUM1301CRWZ-RL | -40°C to +105°C | 16-Lead SOIC Wide | Reel, 1000 | RW-16 |
| ADUM1301WSRWZ | -40°C to +125°C | 16-Lead SOIC Wide | | RW-16 |
| ADUM1301WSRWZ-RL | -40°C to +125°C | 16-Lead SOIC Wide | Reel, 1000 | RW-16 |
| ADUM1301WTRWZ | -40°C to +125°C | 16-Lead SOIC Wide | | RW-16 |
| ADUM1301WTRWZ-RL | -40°C to +125°C | 16-Lead SOIC Wide | Reel, 1000 | RW-16 |

¹ Z = RoHS Compliant Part.

² W = Qualified for Automotive Applications.

³ The addition of an -RL suffix designates a 13" (1,000 units) tape-and-reel option.

⁴ RW-16 = 16-lead wide body SOIC.

NUMBER OF INPUTS, MAXIMUM DATA RATE, MAXIMUM PROPAGATION DELAY AND MAXIMUM PULSE WIDTH DISTORTION

| Model ^{1, 2, 3} | Number of Inputs, V _{DD1} Side | Number of Inputs, V _{DD2} Side | Maximum Data Rate (Mbps) | Maximum Propagation Delay, 5 V (ns) | Maximum Pulse Width Distortion (ns) |
|--------------------------|---|---|--------------------------|-------------------------------------|-------------------------------------|
| ADUM1300ARW | 3 | 0 | 1 | 100 | 40 |
| ADUM1300ARW-RL | 3 | 0 | 1 | 100 | 40 |
| ADUM1300ARWZ | 3 | 0 | 1 | 100 | 40 |
| ADUM1300ARWZ-RL | 3 | 0 | 1 | 100 | 40 |

OUTLINE DIMENSIONS

| Model ^{1,2,3} | Number of Inputs, V _{DD1} Side | Number of Inputs, V _{DD2} Side | Maximum Data Rate (Mbps) | Maximum Propagation Delay, 5 V (ns) | Maximum Pulse Width Distortion (ns) |
|------------------------|---|---|--------------------------|-------------------------------------|-------------------------------------|
| ADUM1300BRWZ | 3 | 0 | 10 | 50 | 3 |
| ADUM1300BRWZ-RL | 3 | 0 | 10 | 50 | 3 |
| ADUM1300CRWZ | 3 | 0 | 90 | 32 | 2 |
| ADUM1300CRWZ-RL | 3 | 0 | 90 | 32 | 2 |
| ADUM1300WSRWZ | 3 | 0 | 1 | 100 | 40 |
| ADUM1300WSRWZ-RL | 3 | 0 | 1 | 100 | 40 |
| ADUM1300WTRWZ | 3 | 0 | 10 | 32 | 3 |
| ADUM1300WTRWZ-RL | 3 | 0 | 10 | 32 | 3 |
| ADUM1301ARW | 2 | 1 | 1 | 100 | 40 |
| ADUM1301ARW-RL | 2 | 1 | 1 | 100 | 40 |
| ADUM1301ARWZ | 2 | 1 | 1 | 100 | 40 |
| ADUM1301ARWZ-RL | 2 | 1 | 1 | 100 | 40 |
| ADUM1301BRW | 2 | 1 | 10 | 50 | 3 |
| ADUM1301BRW-RL | 2 | 1 | 10 | 50 | 3 |
| ADUM1301BRWZ | 2 | 1 | 10 | 50 | 3 |
| ADUM1301BRWZ-RL | 2 | 1 | 10 | 50 | 3 |
| ADUM1301CRW | 2 | 1 | 90 | 32 | 2 |
| ADUM1301CRWZ | 2 | 1 | 90 | 32 | 2 |
| ADUM1301CRWZ-RL | 2 | 1 | 90 | 32 | 2 |
| ADUM1301WSRWZ | 2 | 1 | 1 | 100 | 40 |
| ADUM1301WSRWZ-RL | 2 | 1 | 1 | 100 | 40 |
| ADUM1301WTRWZ | 2 | 1 | 10 | 32 | 3 |
| ADUM1301WTRWZ-RL | 2 | 1 | 10 | 32 | 3 |

¹ Z = RoHS Compliant Part.

² W = Qualified for Automotive Applications.

³ The addition of an -RL suffix designates a 13" (1,000 units) tape-and-reel option.

EVALUATION BOARDS

| Model ¹ | Description |
|--------------------|------------------|
| EVAL-ADuMQSEBZ | Evaluation Board |

¹ Z = RoHS Compliant Part.

OUTLINE DIMENSIONS

AUTOMOTIVE PRODUCTS

The ADuM1300W/ADuM1301W models are available with controlled manufacturing to support the quality and reliability requirements of automotive applications. Note that these automotive models may have specifications that differ from the commercial models; therefore, designers should review the [Specifications](#) section of this data sheet carefully. Only the automotive grade products shown are available for use in automotive applications. Contact your local Analog Devices account representative for specific product ordering information and to obtain the specific Automotive Reliability reports for these models.