

LNB VOLTAGE REGULATOR WITH I²C INTERFACE

 Check for Samples: [TPS65233](#)

FEATURES

- Complete Integration Solution for LNB and I²C
- DiSEqC 1.x Compatible
- Supports 5-V and 12-V Power Bus
- Up to 1000-mA Accurate Output Current Limit Adjustable by External Resistor and I²C
- Boost Converter With Low R_{dson} Internal Power Switch
- Dedicated Enable Pin for Non-I²C Application
- Low Noise, Low Drop Output With Push-Pull Output Stage
- Built-In Accurate 22-kHz Tone Generator or External Pin
- Adjustable Soft-Start and 13-V/18-V Voltage Transition Time
- Compliant with main satellite receiver systems Specifications
- LNB Short Circuit Dynamic Protection
- Diagnostics for Output Voltage Level, Input Supply UVLO, and DiSEqC Tone Output
- Cable Disconnect Diagnostic
- Available in a 16-Pin QFN 3-mm x 3-mm (RTE) Package

APPLICATIONS

- Set Top Box Satellite Receiver
- TV Satellite Receiver
- PC Card Satellite Receiver

DESCRIPTION/ORDERING INFORMATION

Designed for analog and digital satellite receivers, the TPS65233 is a monolithic voltage regulator with I²C interface, specifically to provide the 13-V/18-V power supply and the 22-kHz tone signaling to the LNB down-converter in the antenna dish or to the multi-switch box. It offers a complete solution with very low component count, low power dissipation together with simple design and I²C standard interfacing.

TPS65233 features high power efficiency. The boost converter integrates a 120-mΩ power MOSFET running at 500-kHz switching frequency. Drop out voltage at the linear regulator is 0.8 V to minimize power loss. TPS65233 provides multiple ways to generate the 22-kHz signal. Integrated linear regulator with push-pull output stage generates clean 22-kHz tone signal superimposed at the output even at zero loading. Current limit of linear regulator can be programmed by external resistor with ±10% accuracy. Full range of diagnostic read by I²C is available for system monitoring.

The part is available in a 16-pin QFN 3-mm x 3-mm (RTE) package.

ORDERING INFORMATION⁽¹⁾

T _A	PACKAGE ⁽²⁾		PART NUMBER	TOP-SIDE MARKING
-40°C to 85°C	16-Pin (QFN) - RTE	Reel of 2500	TPS65233RTE	TPS65233RTE

(1) For the most current packaging and ordering information, see the Package Option Addendum at the end of this document, or see the TI web site at www.ti.com.

(2) Package drawings, thermal data, and symbolization are available at www.ti.com/packaging.



Please be aware that an important notice concerning availability, standard warranty, and use in critical applications of Texas Instruments semiconductor products and disclaimers thereto appears at the end of this data sheet.



This integrated circuit can be damaged by ESD. Texas Instruments recommends that all integrated circuits be handled with appropriate precautions. Failure to observe proper handling and installation procedures can cause damage.

ESD damage can range from subtle performance degradation to complete device failure. Precision integrated circuits may be more susceptible to damage because very small parametric changes could cause the device not to meet its published specifications.

FUNCTIONAL BLOCK DIAGRAM

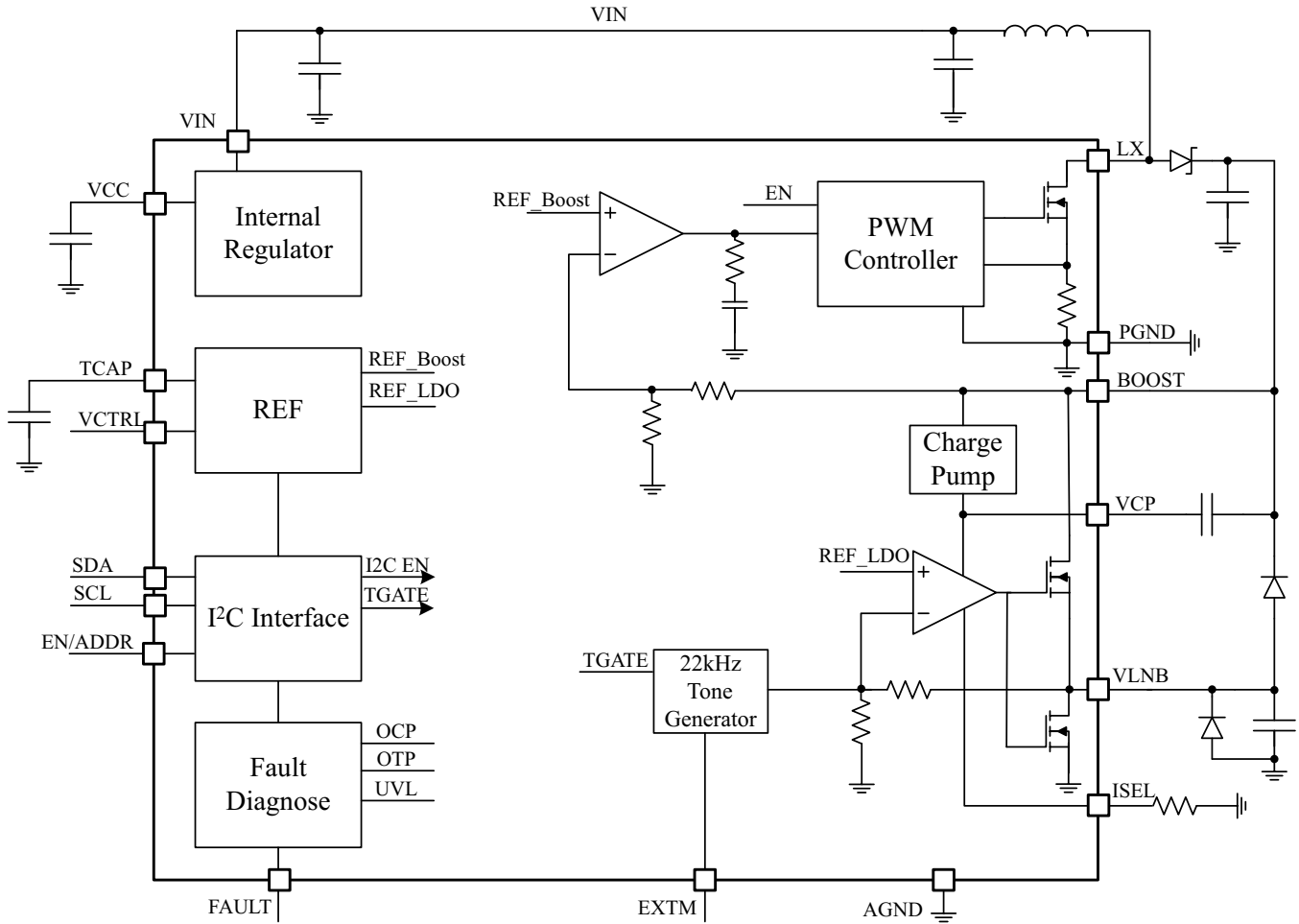

TYPICAL APPLICATION

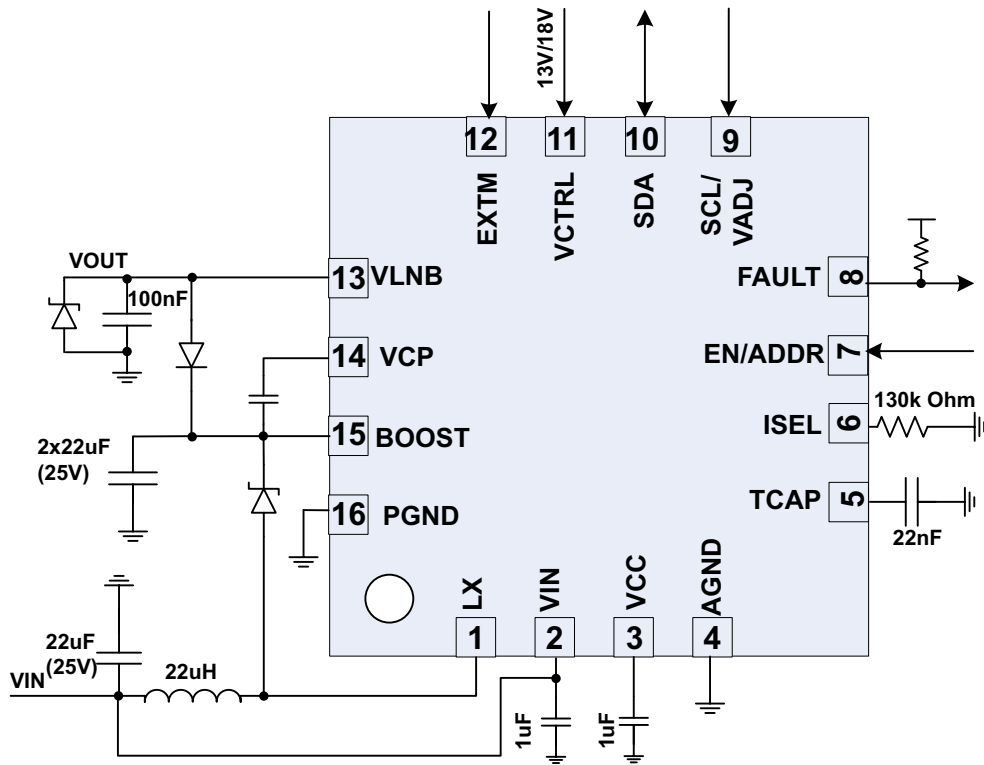

PIN OUT

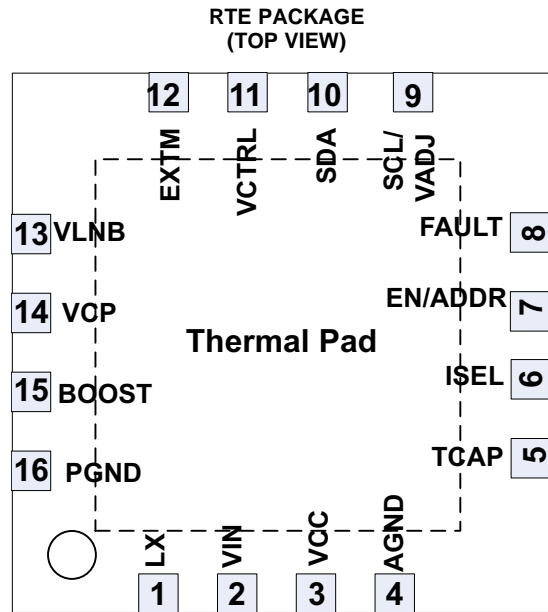

Exposed pad must be soldered to PCB for optimal thermal performance.

TERMINAL FUNCTIONS

NAME	NO.	DESCRIPTION
LX	1	Switching node of the boost converter
VIN	2	Input of internal linear regulator
VCC	3	Internal 6.5-V power supply bias. Connect a 1- μ F ceramic capacitor from this pin to ground. When V_{IN} is 5 V, connect VCC to V_{IN} .
AGND	4	Analog ground. Connect all ground pins and power pad together.
TCAP	5	Connect a capacitor to this pin to set the rise time and fall time of the LNB output between 13 V and 18 V.
ISEL	6	Connect a resistor to this pin to set the LNB output current limit.
EN/ADDR	7	Enable pin to enable the whole chip; pull to ground to disable output, output will be pulled to ground. For I ² C interface, pulling this pin high or low gives different I ² C addresses.
FAULT	8	This pin is an open drain output pin, it goes low if any fault flag is set.
SCL/VADJ	9	I ² C compatible clock input; if I ² C function is not used, connect this pin to low set output voltage 13 V/18 V, connect to high set output voltage 13.4 V/18.6 V.
SDA	10	I ² C compatible bi-directional data
VCTRL	11	Logic control pin for 13-V or 18-V voltage selection at LNB output
EXTM	12	External modulation logic input pin which activates the 22-kHz tone output, feeding signal can be 22-kHz tone or logic high or low.
VLNB	13	Output of the LNB power supply connected to satellite receiver or switch
VCP	14	Gate drive supply voltage, output of charge pump, connect a capacitor between this pin to pin BOOST.
BOOST	15	Output of the boost regulator and input voltage of the internal linear regulator
PGND	16	Power ground for Boost Converter
Thermal PAD		Must be soldered to PCB for optimal thermal performance. Have thermal vias on the PCB to enhance power dissipation.

ABSOLUTE MAXIMUM RATINGS ⁽¹⁾

over operating free-air temperature range (unless otherwise noted, all voltages are with respect to GND)

	Voltage range at VIN, LX, BOOST, VLNB	-1 to 30	V
	Voltage range at VCP	BOOST + 7V	V
	Voltage at LX	-1 to 30	V
	Voltage at VCC, EN, FAULT, SCL, SDA, VCTRL, ISEL, EXTM	-0.3 to 7	V
	Voltage at TCAP	-0.3 to 3.6	V
	Voltage at PGND, AGND	-0.3 to 0.3	V
T _J	Operating junction temperature range	-40 to 125	°C
T _{STG}	Storage temperature range	-55 to 150	°C

(1) Stresses beyond those listed under "absolute maximum ratings" may cause permanent damage to the device. These are stress ratings only, and functional operation of the device at these or any other conditions beyond those indicated under "recommended operating conditions" is not implied. Exposure to absolute-maximum-rated conditions for extended periods may affect device reliability.

RECOMMENDED OPERATING CONDITIONS

over operating free-air temperature range (unless otherwise noted)

		MIN	NOM	MAX	UNIT
VIN	Input operating voltage	4.5		20	V
T _A	Junction temperature	-40		85	°C

THERMAL INFORMATION

THERMAL METRIC ⁽¹⁾		TPS65233	UNITS
		RTE	
		16 PINS	
θ _{JA}	Junction-to-ambient thermal resistance ⁽²⁾	43.4	°C/W
θ _{JCtop}	Junction-to-case (top) thermal resistance ⁽³⁾	45.6	
θ _{JB}	Junction-to-board thermal resistance ⁽⁴⁾	15	
ψ _{JT}	Junction-to-top characterization parameter ⁽⁵⁾	0.6	
ψ _{JB}	Junction-to-board characterization parameter ⁽⁶⁾	15	
θ _{JCbot}	Junction-to-case (bottom) thermal resistance ⁽⁷⁾	3.3	

- (1) For more information about traditional and new thermal metrics, see the *IC Package Thermal Metrics* application report, [SPRA953](#).
- (2) The junction-to-ambient thermal resistance under natural convection is obtained in a simulation on a JEDEC-standard, high-K board, as specified in JESD51-7, in an environment described in JESD51-2a.
- (3) The junction-to-case (top) thermal resistance is obtained by simulating a cold plate test on the package top. No specific JEDEC-standard test exists, but a close description can be found in the ANSI SEMI standard G30-88.
- (4) The junction-to-board thermal resistance is obtained by simulating in an environment with a ring cold plate fixture to control the PCB temperature, as described in JESD51-8.
- (5) The junction-to-top characterization parameter, ψ_{JT}, estimates the junction temperature of a device in a real system and is extracted from the simulation data for obtaining θ_{JA}, using a procedure described in JESD51-2a (sections 6 and 7).
- (6) The junction-to-board characterization parameter, ψ_{JB}, estimates the junction temperature of a device in a real system and is extracted from the simulation data for obtaining θ_{JA}, using a procedure described in JESD51-2a (sections 6 and 7).
- (7) The junction-to-case (bottom) thermal resistance is obtained by simulating a cold plate test on the exposed (power) pad. No specific JEDEC standard test exists, but a close description can be found in the ANSI SEMI standard G30-88.

ELECTROSTATIC DISCHARGE (ESD) PROTECTION

	MIN	MAX	UNIT
Human body model (HBM), pin 13 (VLNB)	6000		V
Human body model (HBM), other pins	2000		V
Charge device model (CDM)	500		V

ELECTRICAL CHARACTERISTICS
 $T_J = -40^{\circ}\text{C}$ to 125°C , $V_{IN} = 12\text{ V}$, $f_{SW} = 528\text{ kHz}$ (unless otherwise noted)

PARAMETER		TEST CONDITIONS	MIN	TYP	MAX	UNIT
INPUT SUPPLY						
V_{IN}	Input voltage range	V_{IN}	4.5	12	20	V
I_{DDSDN}	Shutdown supply current	$EN = 0$		160		μA
I_{DDQ}	Quiescent power supply current	$EN = 1, I_{OUT} = 0\text{ A}, V_{LNB} = 18\text{ V}$		23		mA
$UVLO$	V_{IN} under voltage lockout	Rising V_{IN}	4.05	4.25	4.45	V
		Falling V_{IN}	3.6	3.8	4.1	
		Hysteresis		450		mV
OUTPUT VOLTAGE						
V_{OUT}	Regulated output voltage	$V_{ctrl} = 1, I_{OUT} = 500\text{ mA}$	18.2	18.6	19	V
		$V_{ctrl} = 0, I_{OUT} = 500\text{ mA}$	13.1	13.4	13.7	
$V_{LINEREG}$	Line regulation-DC	$V_{IN} = 7.5\text{ V to }16\text{ V}, I_{OUT} = 500\text{ mA}$		0.2		$\%/V$
$V_{LOADREG}$	Load regulation-DC	$I_{OUT} = (10\text{-}90\%)*I_{OUTMAX}$		0.7		$\%/A$
$IOCP$	Output short circuit current limit	$R_{SEL} = 200\text{ k}\Omega, T_J = 25^{\circ}\text{C}$	580	650	720	mA
T_r, T_f	13 V/18 V Transition rising falling time	$C_{cap} = 5.6\text{ nF}$		0.33		ms
f_{SW}	Boost switching frequency		490	528	570	kHz
$I_{limitsw}$	Switching current limit	$V_{IN} = 12\text{ V}, V_{OUT} = 18.6\text{ V}$		3.2		A
R_{dson_LS}	On resistance of low side FET on CH	$V_{IN} = 12\text{ V}$		120		$\text{m}\Omega$
V_{drop}	Linear regulator voltage drop-out	$I_{OUT} = 500\text{ mA}$		0.8		V
I_{rev}	Reverse bias current	$EN = 1, V_{LNB} = 21\text{ V}$		50		mA
I_{rev_dis}	Disabled reverse bias current	$EN = 0, V_{LNB} = 21\text{ V}$		3		mA
LOGIC SIGNALS						
V_{EN}	Enable threshold level			1.15		V
V_{ENH}	Enable threshold level hysteresis			80		mV
V_{LOGICH}, V_{LOGICL}	V_{CTRL}, EXTM Logic threshold level	High level input voltage	2			V
		Low level input voltage			0.8	
V_{OL_FAULT}	FAULT Output low voltage	FAULT open drain, $I_{OL} = 1\text{ mA}$			0.4	V
f_{I2C}	Maximum I ² C clock frequency		400			kHz
TONE						
f_{tone}	Tone frequency		20	22	24	kHz
A_{tone}	Tone amplitude	$I_{OUT} = 0\text{ mA to }500\text{ mA}, C_{OUT} = 100\text{ nF}$	550	680	750	mV
D_{tone}	Tone duty cycle		45	50	55	%
T_{rtone}	Tone rise time	$I_{OUT} = 0\text{ mA to }500\text{ mA}, C_{OUT} = 100\text{ nF}$		10		μS
T_{ftone}	Tone fall time	$I_{OUT} = 0\text{ mA to }500\text{ mA}, C_{OUT} = 100\text{ nF}$		10		μS
PROTECTION						
TON	Over Current Protection On Time			4		ms
$TOFF$	Over Current Protection Off Time			128		ms

ELECTRICAL CHARACTERISTICS (continued)
 $T_J = -40^{\circ}\text{C}$ to 125°C , $V_{IN} = 12\text{ V}$, $f_{SW} = 528\text{ kHz}$ (unless otherwise noted)

PARAMETER	TEST CONDITIONS	MIN	TYP	MAX	UNIT
THERMAL SHUTDOWN					
T_{TRIP}	Thermal shut down trip point		160		$^{\circ}\text{C}$
T_{HYST}	Thermal shut down hysteresis		20		$^{\circ}\text{C}$
I²C READ BACK FAULT STATUS					
V_{PGOOD}	PGOOD Trip levels	Feedback voltage low side rising	95.3		%
		Feedback voltage low side falling	94.7		
		Feedback voltage high side rising	105.3		
		Feedback voltage high side falling	104.7		
T_{warn}	Temperature warning threshold		125		$^{\circ}\text{C}$
I²C INTERFACE					
V_{IH}	SDA,SCL Input high voltage		2		V
V_{IL}	SDA,SCL Input low voltage			0.8	V
I_I	Input current	SDA, SCL, $V_I = 0.4\text{ V}$ to 4.5 V	-10	10	μA
V_{OL}	SDA Output low voltage	SDA open drain, $I_{OL} = 2\text{ mA}$		0.4	V
$f_{(SCL)}$	Maximum SCL clock frequency		400		kHz
t_{BUF}	Bus free time between a STOP and START condition		1.3		μs
t_{HD_STA}	Hold time (Repeated) START condition		0.6		μs
t_{SU_STO}	Setup time for STOP condition		0.6		μs
t_{LOW}	LOW Period of the SCL clock		1.3		μs
t_{HIGH}	HIGH Period of the SCL clock		0.6		μs
t_{SU_STA}	Setup time for a repeated START condition		0.6		μs
t_{SU_DAT}	Data setup time		0.1		μs
t_{HD_DAT}	Data hold time		0	0.9	μs
t_{RCL}	Rise time of SCL signal	Capacitance of one bus line (pF)	$20 + 0.1C_B$	300	ns
t_{RCL1}	Rise time of SCL signal after a repeated START condition and after an acknowledge BIT	Capacitance of one bus line (pF)	$20 + 0.1C_B$	300	ns
t_{FCL}	Fall time of SCL signal	Capacitance of one bus line (pF)	$20 + 0.1C_B$	300	ns
t_{RDA}	Rise time of SDA signal	Capacitance of one bus line (pF)	$20 + 0.1C_B$	300	ns
t_{FDA}	Fall time of SDA signal	Capacitance of one bus line (pF)	$20 + 0.1C_B$	300	ns
C_B	Capacitance of one bus line (SCL and SDA)			400	pF

TYPICAL CHARACTERISTICS

$T_A = 25^\circ\text{C}$, $V_{IN} = 12\text{ V}$, $f_{SW} = 528\text{ kHz}$, $C_{boost} = 2 \times 22\ \mu\text{F}$ (unless otherwise noted)

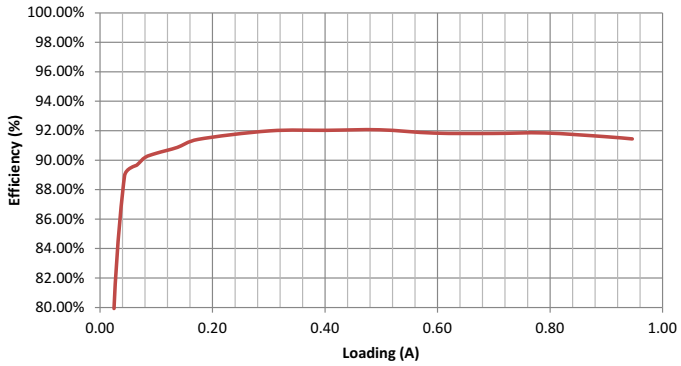

Figure 1. Efficiency ($V_{IN} = 12\text{ V}$, $V_{LNB} = 13.4\text{ V}$)

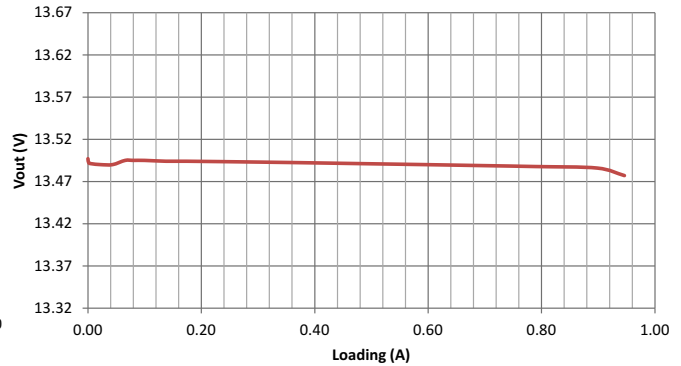

Figure 2. Load Regulation ($V_{IN} = 12\text{ V}$, $V_{LNB} = 13.4\text{ V}$)

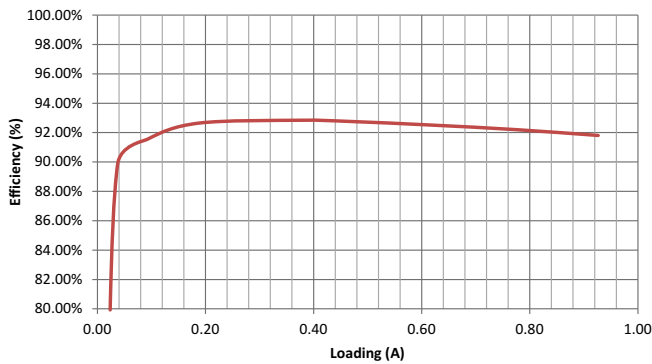

Figure 3. Efficiency ($V_{IN} = 12\text{ V}$, $V_{LNB} = 18.6\text{ V}$)

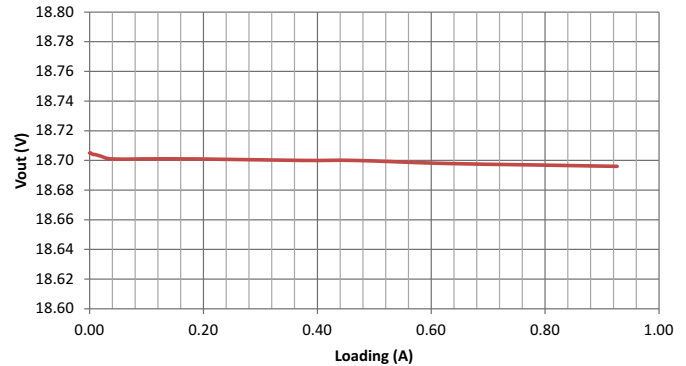

Figure 4. Load Regulation ($V_{IN} = 12\text{ V}$, $V_{LNB} = 18.6\text{ V}$)

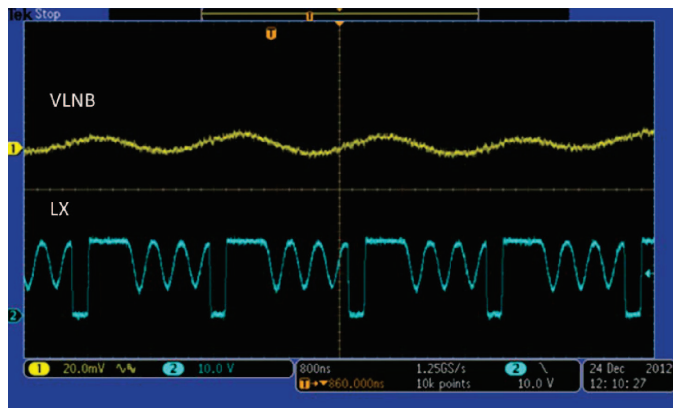

Figure 5. Boost LX Waveform at 0 A, ($V_{IN} = 12\text{ V}$, $V_{LNB} = 13.4\text{ V}$)

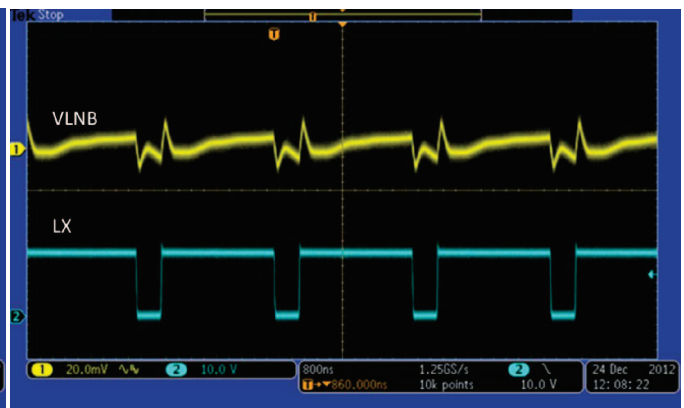

Figure 6. Boost LX Waveform at 0.5 A, ($V_{IN} = 12\text{ V}$, $V_{LNB} = 13.4\text{ V}$)

TYPICAL CHARACTERISTICS (continued)

$T_A = 25^\circ\text{C}$, $V_{IN} = 12\text{ V}$, $f_{SW} = 528\text{ kHz}$, $C_{boost} = 2 \times 22\ \mu\text{F}$ (unless otherwise noted)

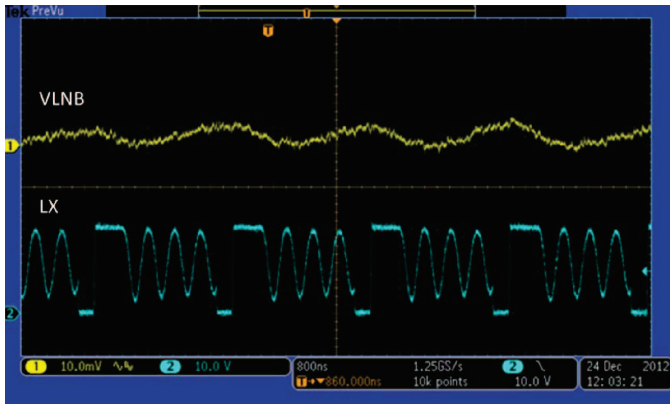

Figure 7. Boost LX Waveform at 0 A, ($V_{IN} = 12\text{ V}$, $V_{LNB} = 18.6\text{ V}$)

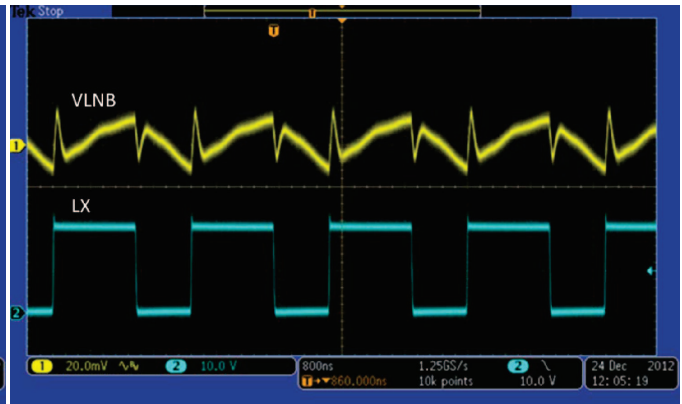

Figure 8. Boost LX Waveform at 0.5 A, ($V_{IN} = 12\text{ V}$, $V_{LNB} = 18.6\text{ V}$)

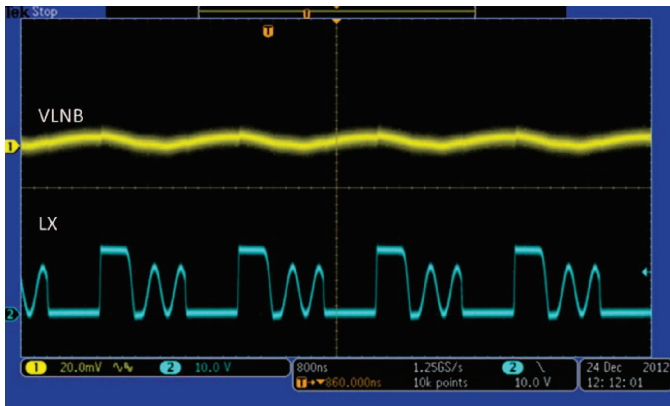

Figure 9. Boost LX Waveform at 0 A, ($V_{IN} = 5\text{ V}$, $V_{LNB} = 13.4\text{ V}$)

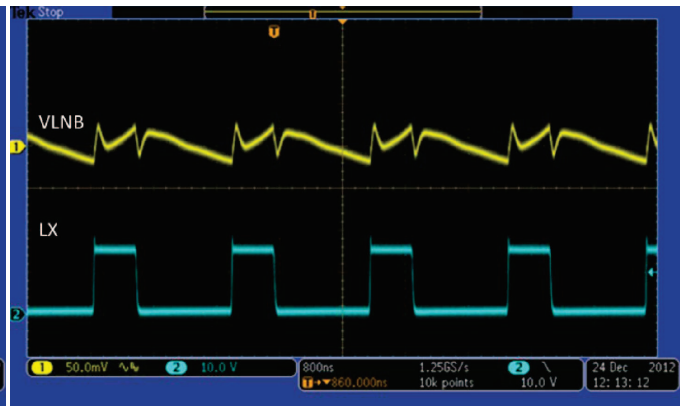

Figure 10. Boost LX Waveform at 0.5 A, ($V_{IN} = 5\text{ V}$, $V_{LNB} = 13.4\text{ V}$)

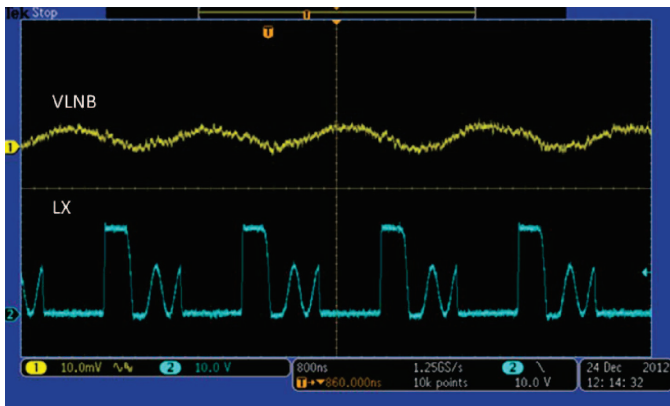

Figure 11. Boost LX Waveform at 0 A, ($V_{IN} = 5\text{ V}$, $V_{LNB} = 18.6\text{ V}$)

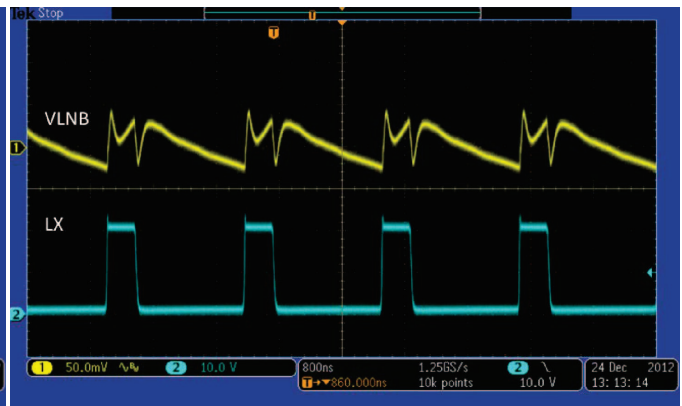

Figure 12. Boost LX Waveform at 0.5 A, ($V_{IN} = 5\text{ V}$, $V_{LNB} = 18.6\text{ V}$)

TYPICAL CHARACTERISTICS (continued)

$T_A = 25^\circ\text{C}$, $V_{IN} = 12\text{ V}$, $f_{SW} = 528\text{ kHz}$, $C_{boost} = 2 \times 22\ \mu\text{F}$ (unless otherwise noted)

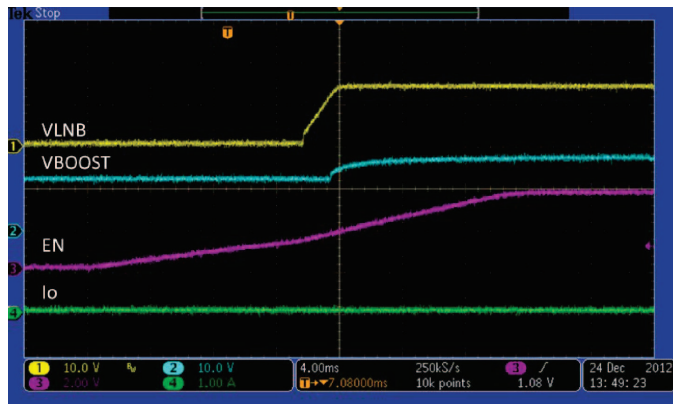

Figure 13. $V_{IN} = 12\text{ V}$, $V_{LNB} = 13.4\text{ V}$, No Loading, Soft Start

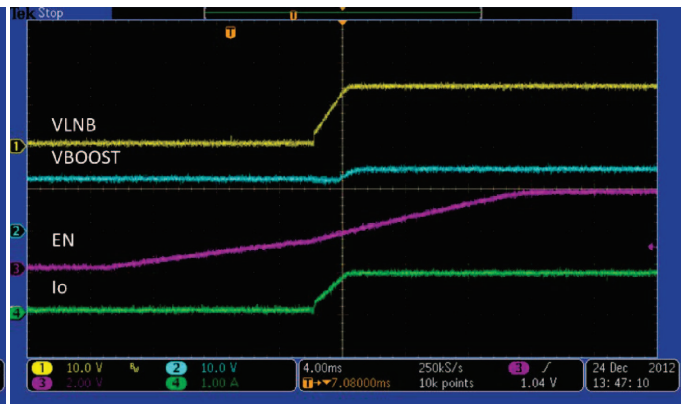

Figure 14. $V_{IN} = 12\text{ V}$, $V_{LNB} = 13.4\text{ V}$, 1 A, Soft Start

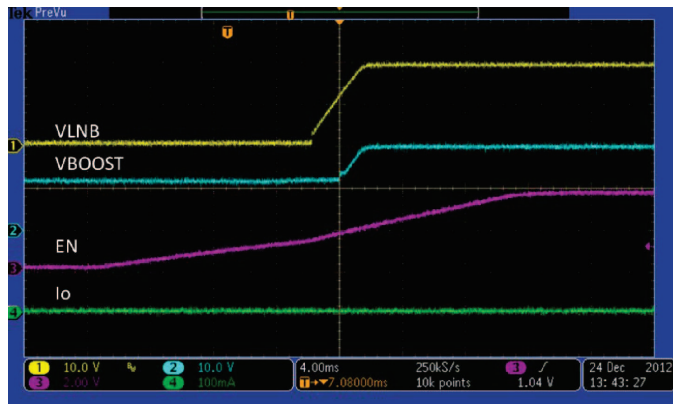

Figure 15. $V_{IN} = 12\text{ V}$, $V_{LNB} = 18.6\text{ V}$, No Loading, Soft Start

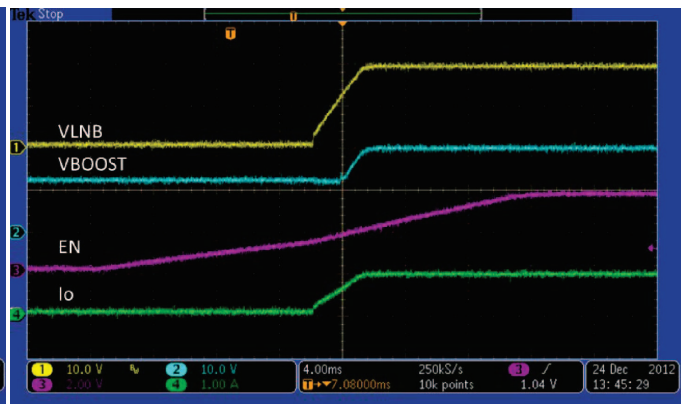

Figure 16. $V_{IN} = 12\text{ V}$, $V_{LNB} = 18.6\text{ V}$, 1 A, Soft Start

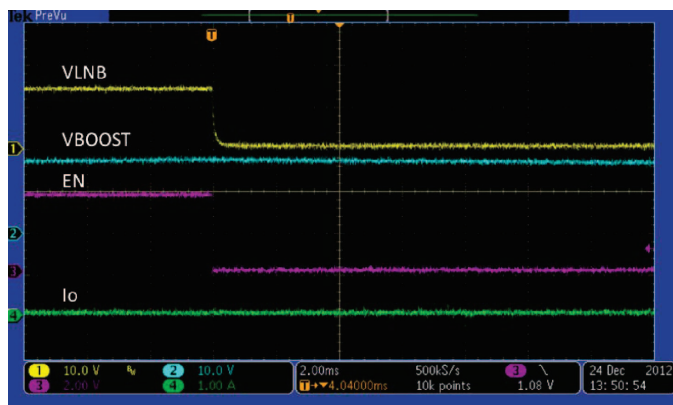

Figure 17. $V_{IN} = 12\text{ V}$, $V_{LNB} = 13.4\text{ V}$, 0 A, Shutdown

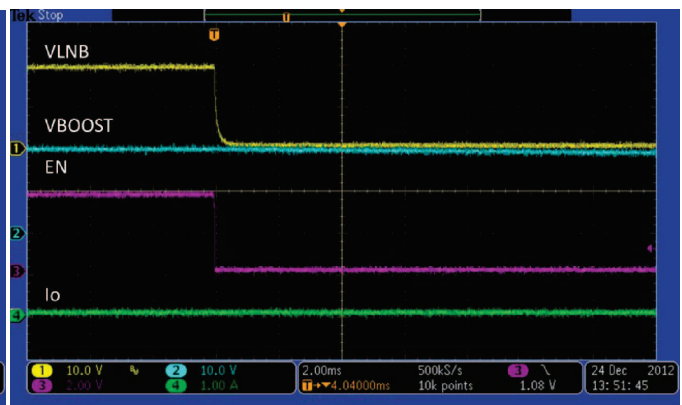

Figure 18. $V_{IN} = 12\text{ V}$, $V_{LNB} = 18.6\text{ V}$, 0 A, Shutdown

TYPICAL CHARACTERISTICS (continued)

$T_A = 25^\circ\text{C}$, $V_{IN} = 12\text{ V}$, $f_{SW} = 528\text{ kHz}$, $C_{boost} = 2 \times 22\ \mu\text{F}$ (unless otherwise noted)

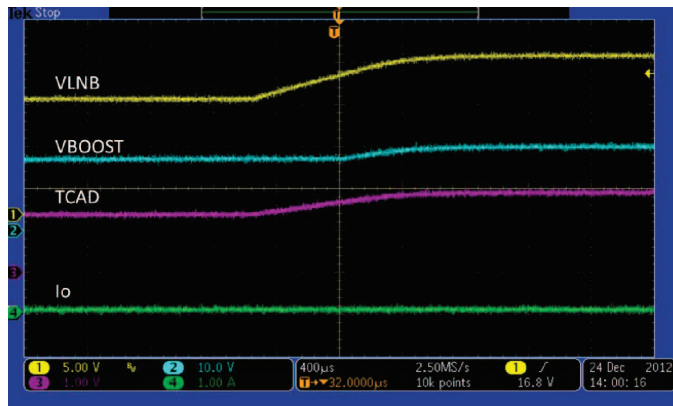

Figure 19. $V_{IN} = 12\text{ V}$, $V_{LNB} = 13.4\text{ V}$ to 18.6 V , 0 A , Voltage Transition

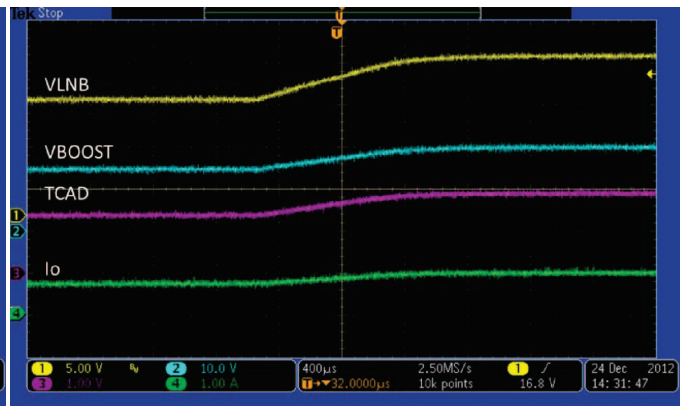

Figure 20. $V_{IN} = 12\text{ V}$, $V_{LNB} = 13.4\text{ V}$ to 18.6 V , 1 A , Voltage Transition

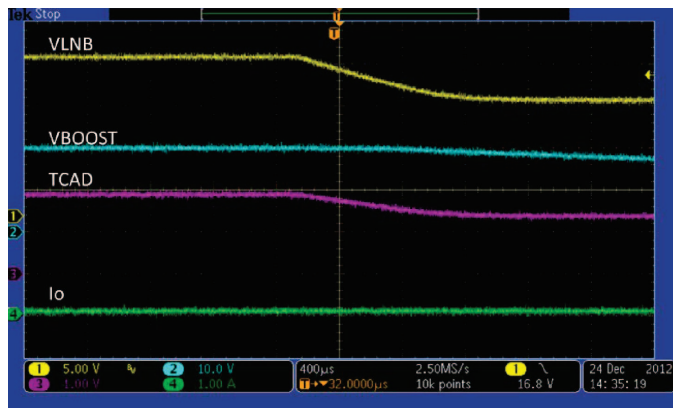

Figure 21. $V_{IN} = 12\text{ V}$, $V_{LNB} = 18.6\text{ V}$ to 13.4 V , 0 A , Voltage Transition

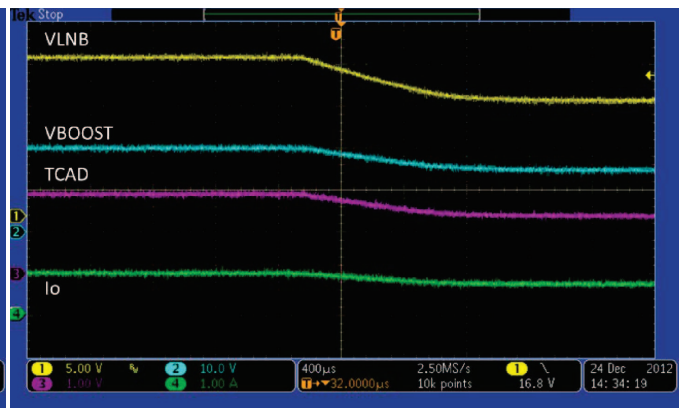

Figure 22. $V_{IN} = 12\text{ V}$, $V_{LNB} = 18.6\text{ V}$ to 13.4 V , 1 A , Voltage Transition

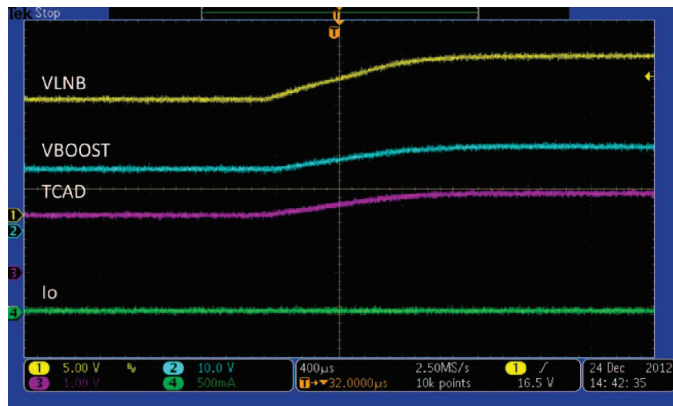

Figure 23. $V_{IN} = 5\text{ V}$, $V_{LNB} = 13.4\text{ V}$ to 18.6 V , 0 A , Voltage Transition

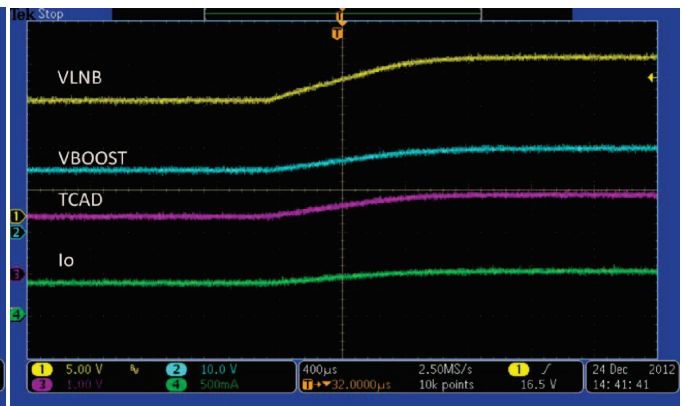

Figure 24. $V_{IN} = 5\text{ V}$, $V_{LNB} = 13.4\text{ V}$ to 18.6 V , 0.5 A , Voltage Transition

TYPICAL CHARACTERISTICS (continued)

$T_A = 25^\circ\text{C}$, $V_{IN} = 12\text{ V}$, $f_{SW} = 528\text{ kHz}$, $C_{boost} = 2 \times 22\ \mu\text{F}$ (unless otherwise noted)

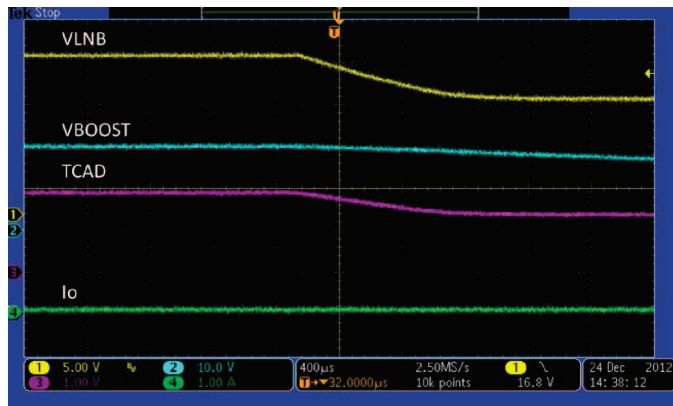

Figure 25. $V_{IN} = 5\text{ V}$, $V_{LNB} = 18.6\text{ V}$ to 13.4 V , 0 A , Voltage Transition

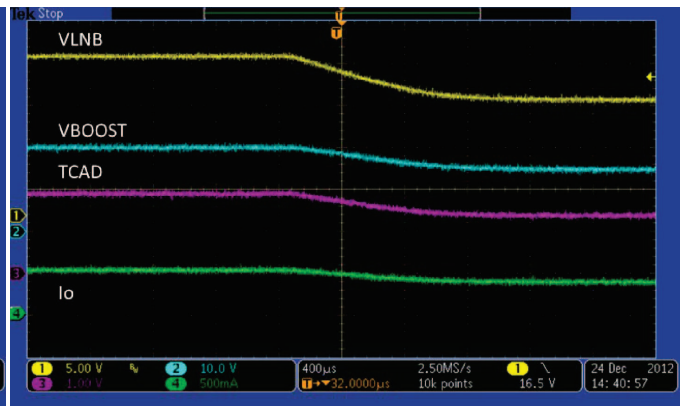

Figure 26. $V_{IN} = 5\text{ V}$, $V_{LNB} = 18.6\text{ V}$ to 13.4 V , 0.5 A , Voltage Transition

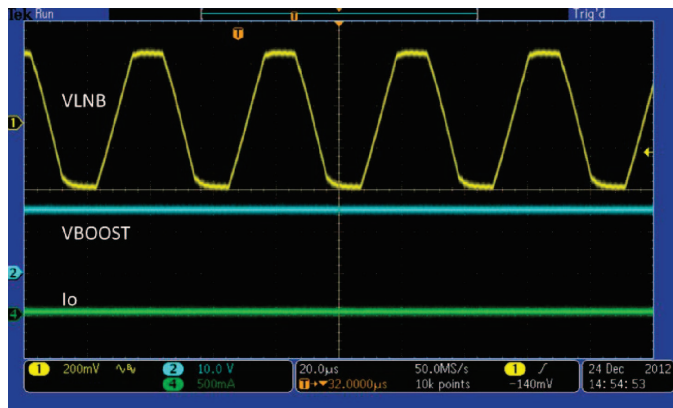

Figure 27. $V_{IN} = 12\text{ V}$, $V_{LNB} = 13.4\text{ V}$, No Loading, 22-kHz Tone

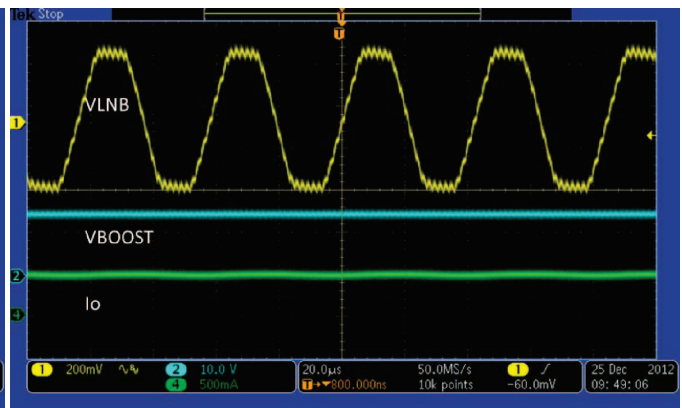

Figure 28. $V_{IN} = 12\text{ V}$, $V_{LNB} = 13.4\text{ V}$, 1 A , 22-kHz Tone

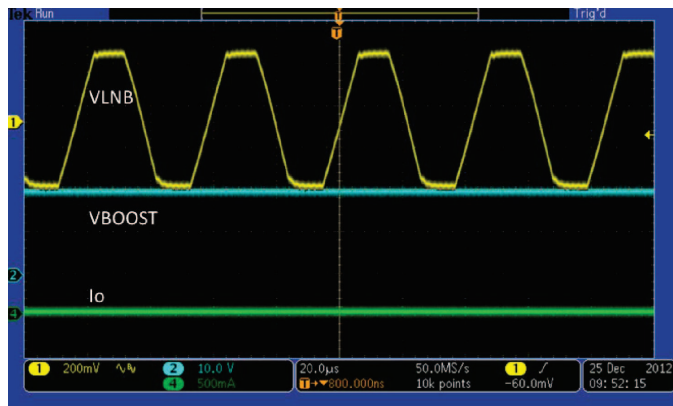

Figure 29. $V_{IN} = 12\text{ V}$, $V_{LNB} = 18.6\text{ V}$, No Loading, 22-kHz Tone

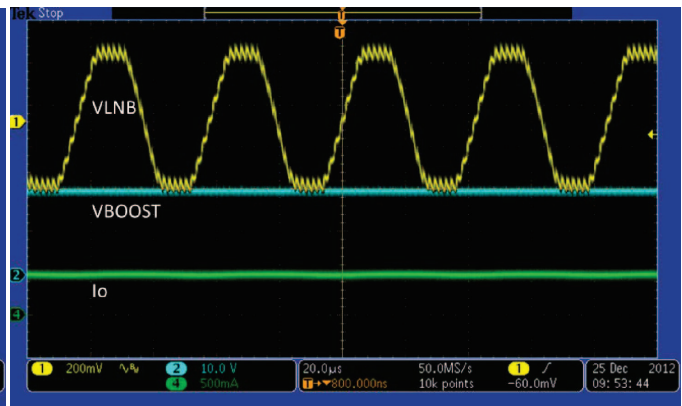

Figure 30. $V_{IN} = 12\text{ V}$, $V_{LNB} = 18.6\text{ V}$, 1 A , 22-kHz Tone

TYPICAL CHARACTERISTICS (continued)

$T_A = 25^\circ\text{C}$, $V_{IN} = 12\text{ V}$, $f_{SW} = 528\text{ kHz}$, $C_{boost} = 2 \times 22\ \mu\text{F}$ (unless otherwise noted)

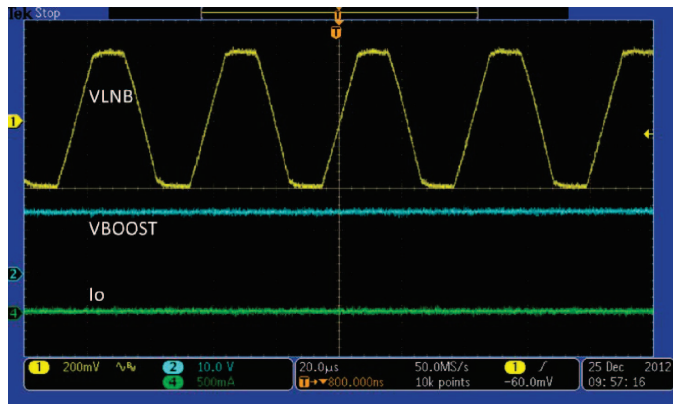

Figure 31. $V_{IN} = 5\text{ V}$, $V_{LNB} = 13.4\text{ V}$, No Loading, 22-kHz Tone

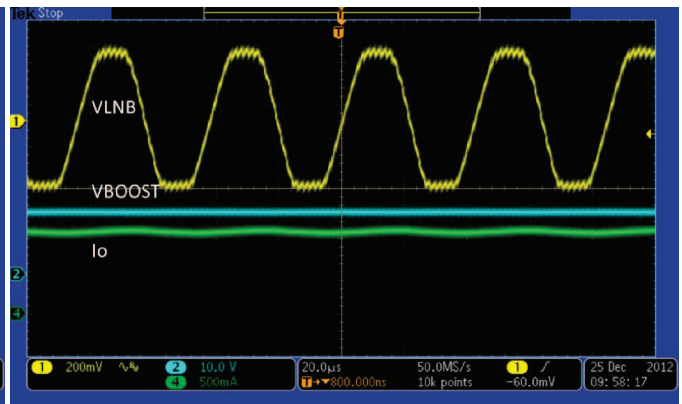

Figure 32. $V_{IN} = 5\text{ V}$, $V_{LNB} = 13.4\text{ V}$, 0.5 A, 22-kHz Tone

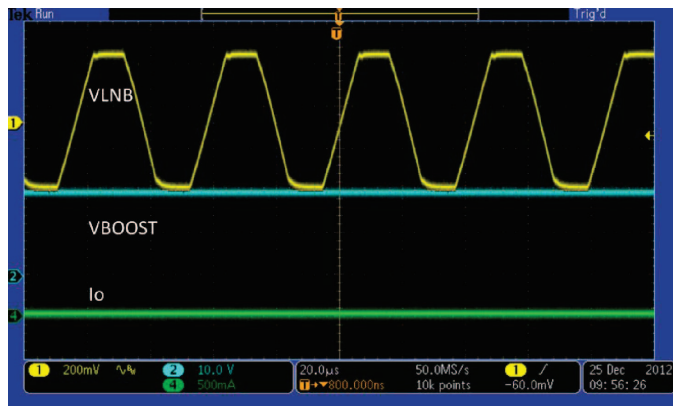

Figure 33. $V_{IN} = 5\text{ V}$, $V_{LNB} = 18.6\text{ V}$, No Loading, 22-kHz Tone

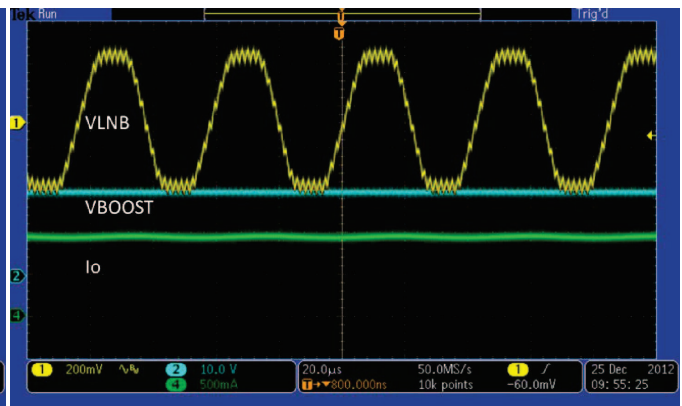

Figure 34. $V_{IN} = 5\text{ V}$, $V_{LNB} = 18.6\text{ V}$, 0.5 A, 22-kHz Tone

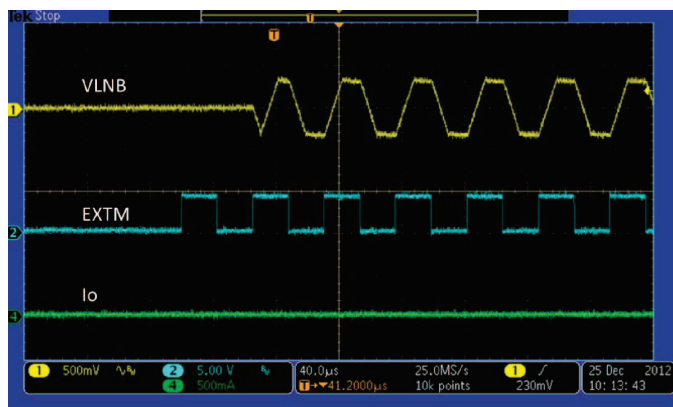

Figure 35. $V_{IN} = 12\text{ V}$, $V_{LNB} = 13.4\text{ V}$, No Loading, 22-kHz Tone Delay from EXTM Turns High to Output Tone, On

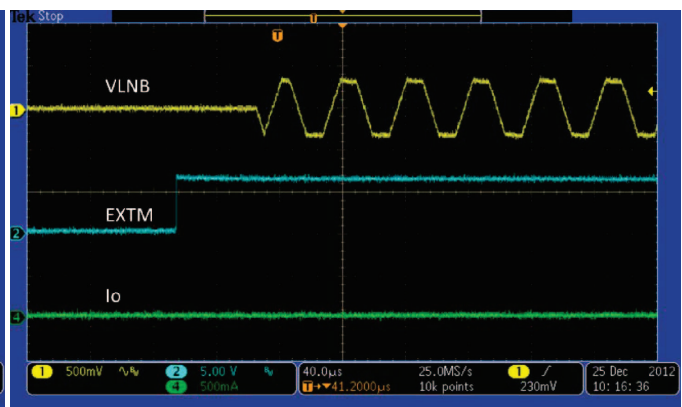

Figure 36. $V_{IN} = 12\text{ V}$, $V_{LNB} = 13.4\text{ V}$, No Loading, 22-kHz Tone Delay from EXTM Turns High to Output Tone, On

TYPICAL CHARACTERISTICS (continued)

$T_A = 25^\circ\text{C}$, $V_{IN} = 12\text{ V}$, $f_{SW} = 528\text{ kHz}$, $C_{boost} = 2 \times 22\ \mu\text{F}$ (unless otherwise noted)

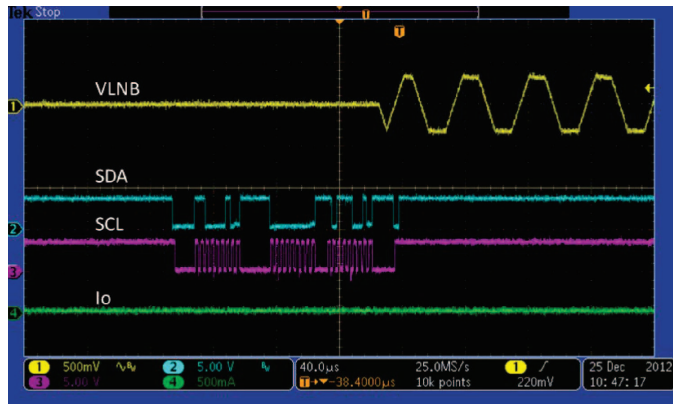

Figure 37. $V_{IN} = 12\text{ V}$, $V_{LNB} = 13.4\text{ V}$, No Loading, 22-kHz Tone Delay from I²C SDA to Output Tone, On

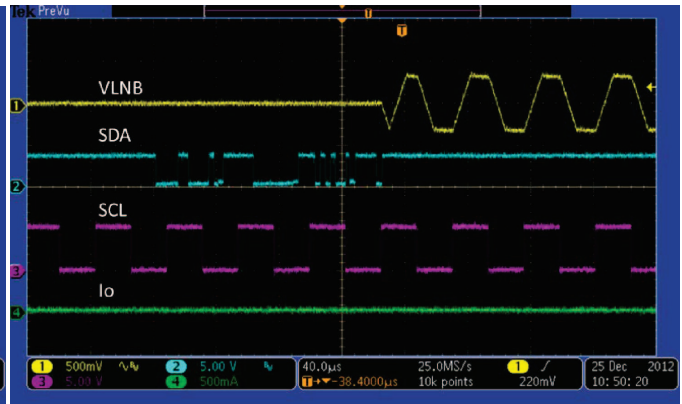

Figure 38. $V_{IN} = 12\text{ V}$, $V_{LNB} = 13.4\text{ V}$, No Loading, 22-kHz Tone Delay from I²C Gated, EXT_M Provides 22 kHz to Output Tone, On

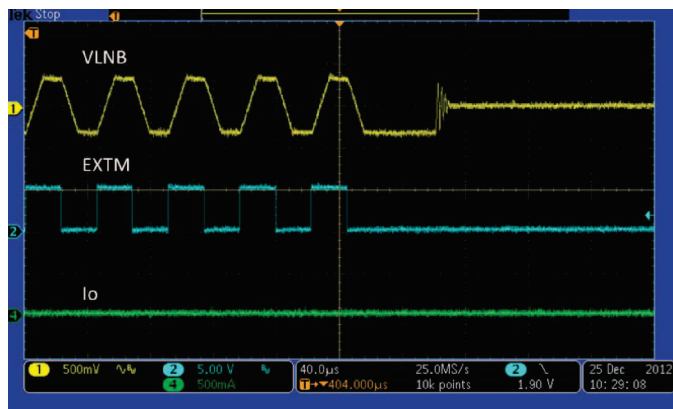

Figure 39. $V_{IN} = 12\text{ V}$, $V_{LNB} = 13.4\text{ V}$, No Loading, 22-kHz Tone Delay from EXT_M 22 kHz to Output Tone, Off

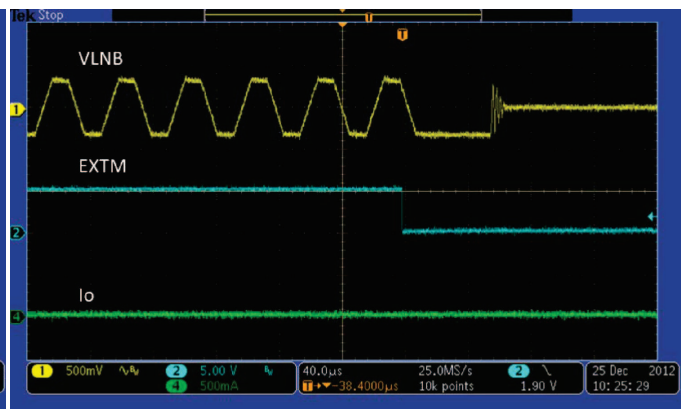

Figure 40. $V_{IN} = 12\text{ V}$, $V_{LNB} = 13.4\text{ V}$, No Loading, 22-kHz Tone Delay from EXT_M Turns High to output Tone, Off

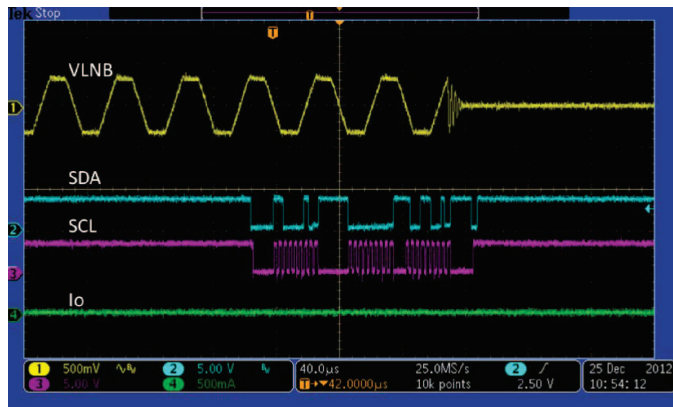

Figure 41. $V_{IN} = 12\text{ V}$, $V_{LNB} = 13.4\text{ V}$, No Loading, 22-kHz Tone Delay from I²C SDA to Output Tone, Off

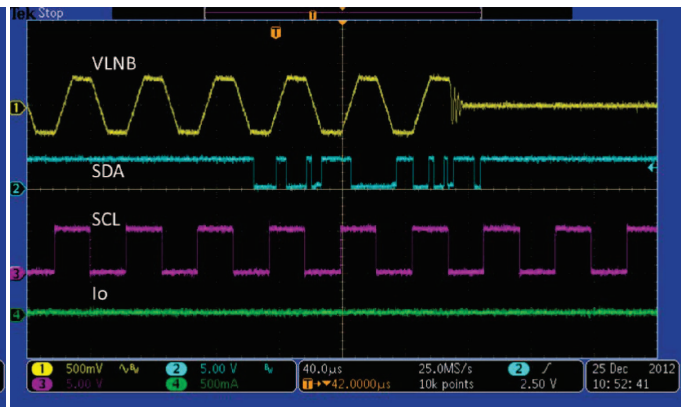

Figure 42. $V_{IN} = 12\text{ V}$, $V_{LNB} = 13.4\text{ V}$, No Loading, 22-kHz Tone Delay from I²C Gated, EXT_M Provides 22 kHz to Output Tone, Off

TYPICAL CHARACTERISTICS (continued)

$T_A = 25^\circ\text{C}$, $V_{IN} = 12\text{ V}$, $f_{SW} = 528\text{ kHz}$, $C_{boost} = 2 \times 22\ \mu\text{F}$ (unless otherwise noted)

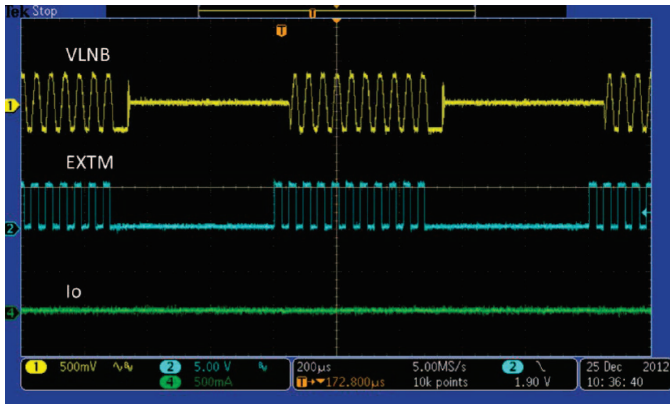

Figure 43. $V_{IN} = 12\text{ V}$, $V_{LNB} = 13.4\text{ V}$, No Loading, Tone Burst

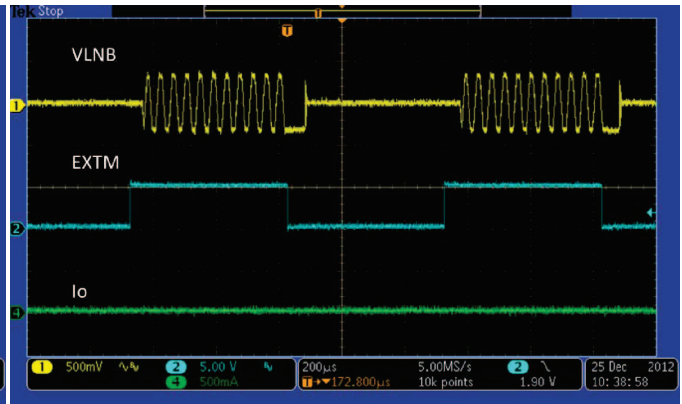

Figure 44. $V_{IN} = 12\text{ V}$, $V_{LNB} = 13.4\text{ V}$, No Loading, EXT_M Level

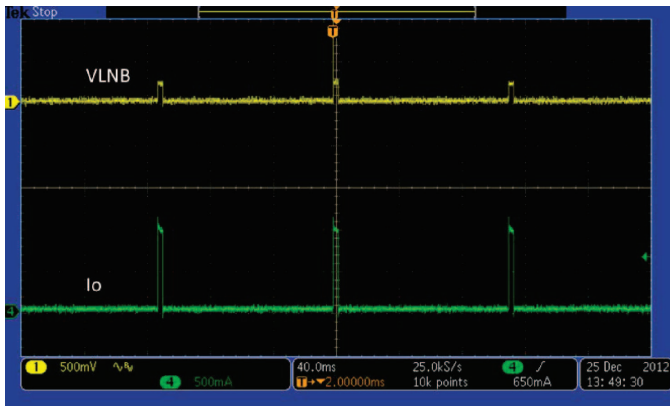

Figure 45. $V_{IN} = 12\text{ V}$, $V_{LNB} = 13.4\text{ V}$, Hard Short

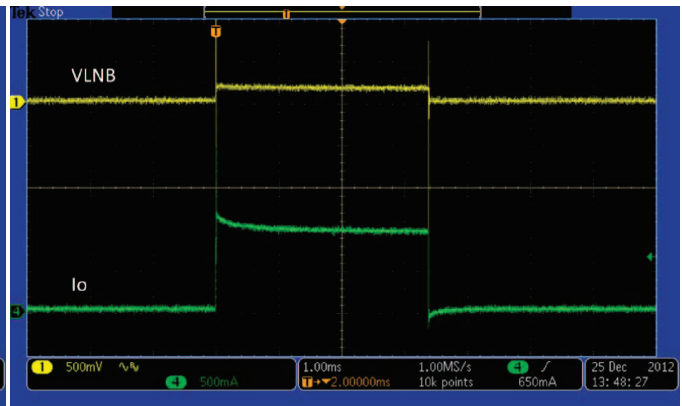

Figure 46. $V_{IN} = 12\text{ V}$, $V_{LNB} = 13.4\text{ V}$, Hard Short

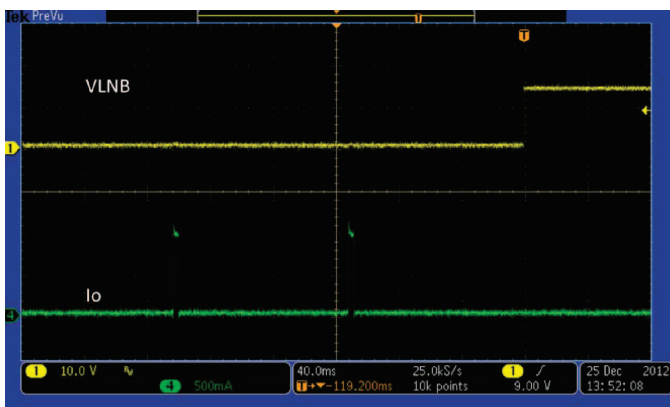

Figure 47. $V_{IN} = 12\text{ V}$, $V_{LNB} = 13.4\text{ V}$, Hard Short Recovery

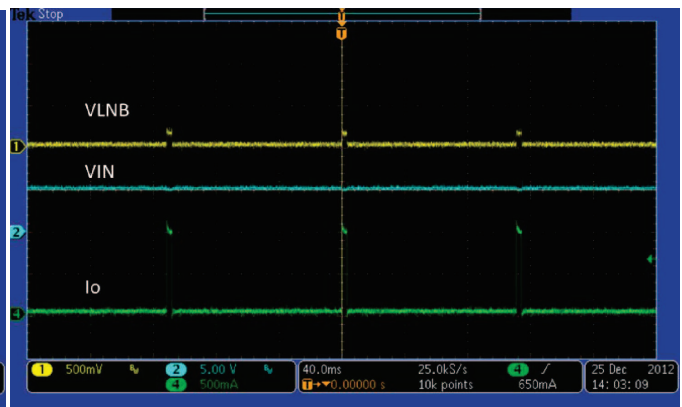

Figure 48. $V_{IN} = 5\text{ V}$, $V_{LNB} = 13.4\text{ V}$, Hard Short

TYPICAL CHARACTERISTICS (continued)

$T_A = 25^\circ\text{C}$, $V_{IN} = 12\text{ V}$, $f_{SW} = 528\text{ kHz}$, $C_{boost} = 2 \times 22\ \mu\text{F}$ (unless otherwise noted)

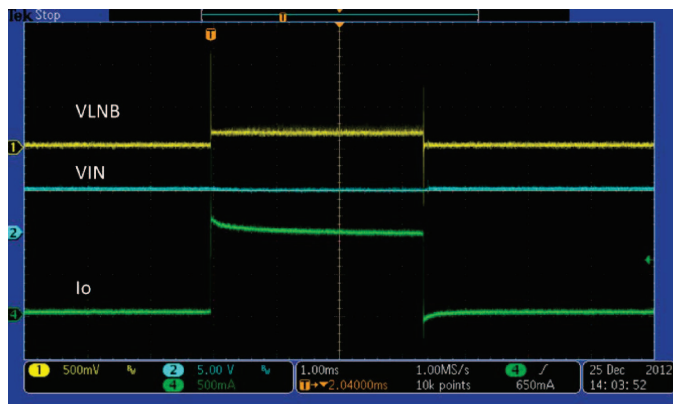

Figure 49. $V_{IN} = 5\text{ V}$, $V_{LNB} = 13.4\text{ V}$, Hard Short

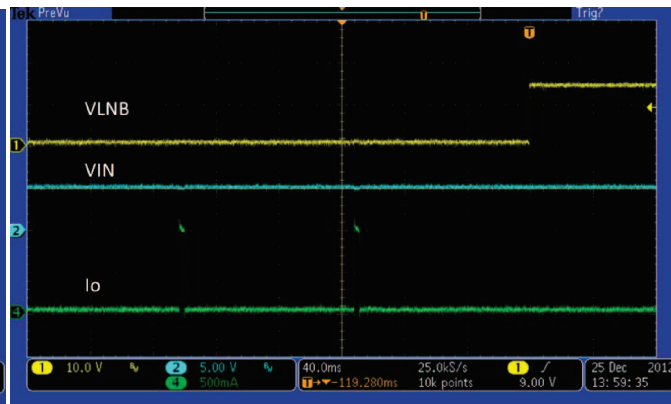

Figure 50. $V_{IN} = 5\text{ V}$, $V_{LNB} = 13.4\text{ V}$, Hard Short Recovery

OVERVIEW

TPS65233 is a power management IC that integrates a boost converter, a LDO and a 22-kHz tone generator serves as a LNB power supply. This solution compiles the DiSEqC 1.x standard with or without I²C interface. Output current can be precisely programmed by an external resistor. There are four ways to generate the 22-kHz tone signal with or without I²C. Integrated boost features low R_{dson} MOSFET and internal compensation. Fixed 500-kHz switching frequency is designed to reduce components size.

DETAILED DESCRIPTION

Boost Converter

The TPS65233 consists of an internal compensated boost converter and linear regulator. The boost converter tracks the output LNB voltage to within 800 mV even at loading 750 mA, to minimize power dissipation. Under conditions where the input voltage, VBOOST, is greater than the output voltage, VLNB, the linear regulator must drop the differential voltage. When operating in these conditions, care must be taken to ensure that the safe operating temperature range of the TPS65233 is not exceeded. The boost converter operates at 528 kHz typical. The TPS65233 has internal pulse-by-pulse current limiting on the boost converter and DC current limiting on the LNB output to protect the IC against short circuits. When the LNB output is shorted, the LNB output current is limited. The current limit is set by the external resistor. And the IC will be shut down if the overcurrent condition lasts for more than 4 ms, the converter enters hiccup mode and will re-try startup in 128 ms. At extremely light loads, the boost converter operates in a pulse-skipping mode.

If two or more set top box LNB outputs are connected together, one output voltage could be set higher than others. The output with lower set voltage would be effectively turned off. Once the voltage drops to the set level, the LNB output with lower set output voltage will return to normal conditions.

Linear Regulator and Current Limit

The linear regulator is used to generate the 22-kHz tone signal by changing the reference voltage. The linear regulator features low drop out voltage to minimize power loss while keeps enough head room for the 0.68-V, 22-kHz tone. It also implements a tight current limit for over current protection. The current limit is set by an external resistor connected to ISEL pin. The curve below shows the relationship between the current limit threshold and the resistor value.

RISEL versus ISEL

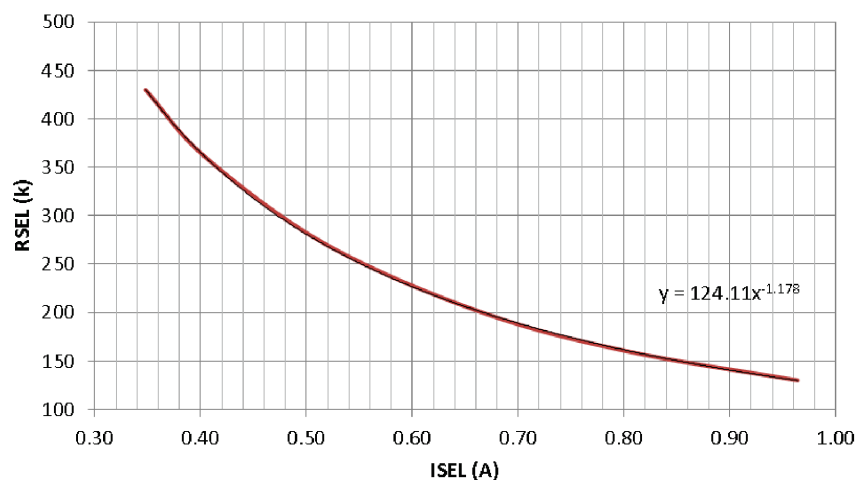

Figure 51. Linear Regulator Current Limit Versus Resistor

$$R_{SEL} (\text{k}\Omega) = 124.11 \cdot I_{SEL}^{-1.178} (\text{A}) \quad (1)$$

A 270-k Ω resistor set the current to be 0.5 A.

The current limit can also be set by I²C through register.

Charge Pump

The charge pump circuitry generates a voltage to drive the NMOS of the linear regulator. One end the charge pump capacitor is connected to the output of the boost converter. The voltage on the charge pump capacitor is about 6.25 V.

Slew Rate Control

When LNB output voltage transits from 13 V to 18 V or vice versa, the capacitor at pin TCAP controls the transition time. This transition is to make sure the boost converter can follow the voltage change. Usually boost converter has low bandwidth and can't response fast. The voltage at TCAP acts as the reference voltage of the linear regulator. The boost converter's reference is also based on TCAP with additional fixed voltage to generate 0.8 V above the output.

The charging and discharging current is 10 μ A, thus the transition time can be calculated as:

$$T_{\text{cad}} (\text{ms}) = 0.5 \cdot \frac{C_{\text{SS}} (\text{nF})}{I_{\text{SS}} (\mu\text{A})} \quad (2)$$

A 22-nF capacitor generates 1.1-ms transition time.

In light load conditions, when LNB output voltage is set from 18 V to 13 V, the voltage might drops very slow, which might cause wrong logic detection at LNB side. TPS65233 has the integrated a pull down circuit to pull down the output during the transition. This will ensure the voltage change can follow the voltage at TCAP. Meanwhile, when 22-kHz tone signal is superimposing on the LNB output voltage, the pull down current can also provide square wave instead of a distorted waveforms, which could cause another detection problem.

Capacitor Selection

TPS65233 works fine with all ceramic capacitors. Two 22- μ F, 35-V capacitors can be put at the output of the boost converter. If lower cost is demanded, a 100- μ F electrolytic and a 1- μ F ceramic capacitor work well also.

Short Circuit Protection, Hiccup and Over Temperature Protection

The LNB output limit can be set by an external resistor. When short circuit conditions occur, the output current is clamped at the current limit for 4 ms. If the condition remains, the converter will shut down for 128 ms and then try restart. This hiccup behavior prevents the IC from overheating.

The low side MOSFET of the boost converter has a current limit threshold at 3.2 A, which serves as secondary protection. If the boost converter's peak current limit is triggered, the peak current will clamp at 3.2 A. If loading current continues to increase, output voltage starts to drop and output power drops.

Thermal shutdown prevents the chip from operating at exceedingly high temperatures. When the silicon die temperature exceeds 160°C, the output shuts down. When the temperature drops below its lower threshold, typically 140°C, the output is enabled.

When the chip is in over current protection or thermal shutdown, the I²C interface and some logic are still active. The Fault pin is pulled down to signal the processor. The Fault pin signal will remain low unless the following actions are taken:

1. If I²C interface is not used to control, Enable pin must be recycled in order to pull Fault pin back to high.
2. If I²C interface is used, the I²C master needs to read the OCP or OTP bit in the register, then the Fault pin returns to high.

Tone Generation

A 22-kHz tone signal is superimposed at the LNB output voltage as a carrier for DiSEqC command. This tone signal can be generated by feeding an external 22-kHz clock at the EXTM pin. It can also be generated with its internal tone generator gated by control logic. The output stage of the regulator facilitates a push-pull circuit, so even at zero loading the 22-kHz tone at the output is still clear of distortion.

There are four ways to generate the 22-kHz tone signal at the output.

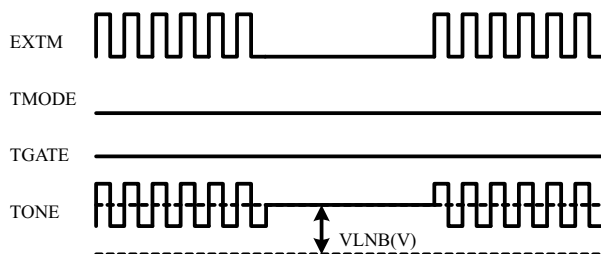

Option 1, Use external tone

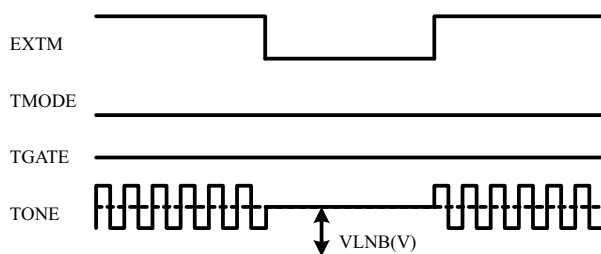

Option 2, Use internal tone, gated by EXTM logic

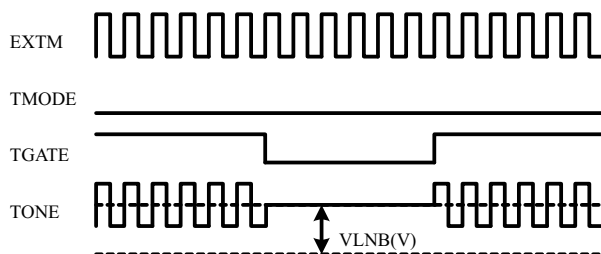

Option 3, Use external tone, gated by TGATE

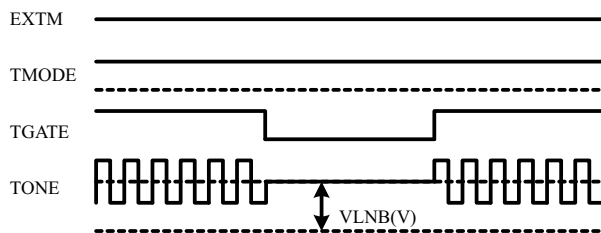

Option 4, Use internal tone, gated by TGATE

Figure 52. Four Ways to Generate 22-kHz Tone

Serial Interface Description

I²C is a 2-wire serial interface developed by Philips Semiconductor (see I²C-Bus Specification, Version 2.1, January 2000). The bus consists of a data line (SDA) and a clock line (SCL) with pull-up structures. When the bus is idle, both SDA and SCL lines are pulled high. All the I²C compatible devices connect to the I²C bus through open drain I/O pins, SDA and SCL. A master device, usually a microcontroller or a digital signal processor, controls the bus. The master is responsible for generating the SCL signal and device addresses. The master also generates specific conditions that indicate the START and STOP of data transfer. A slave device receives and transmits data on the bus under control of the master device.

The TPS65233 device works as a slave and supports the following data transfer modes, as defined in the I²C-Bus Specification: standard mode (100 kbps), and fast mode (400 kbps). The interface adds flexibility to the power supply solution, enabling most functions to be programmed to new values depending on the instantaneous application requirements. Register contents remain intact as long as supply voltage remains above 4.5 V (typical).

The data transfer protocol for standard and fast modes is exactly the same; therefore, they are referred to as F/S-mode in this document. The TPS65233 device supports 7-bit addressing; 10-bit addressing and general call address are not supported.

The TPS65233 device has a 7-bit address with the 2 LSB bits set by EN pin. Connecting EN to ground set the address 0x60H, connecting to high set the address 0x61H.

Table 1. I²C Address Selection

EN/ADDR PIN	I ² C ADDRESS
Connect to Ground	0x60H
Connect to High	0x61H

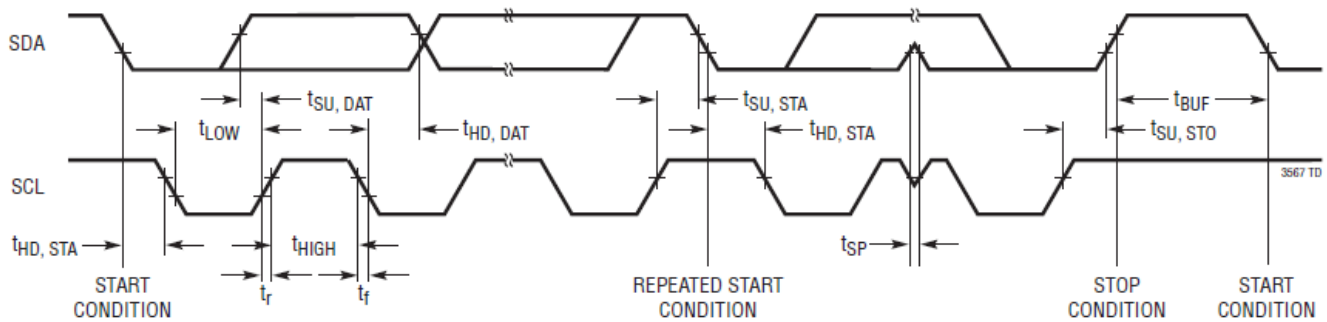

Figure 53. I²C Interface Timing Diagram

TPS65233 I²C Update Sequence

The TPS65233 requires a start condition, a valid I²C address, a register address byte, and a data byte for a single update. After the receipt of each byte, TPS65233 device acknowledges by pulling the SDA line low during the high period of a single clock pulse. TPS65233 performs an update on the falling edge of the LSB byte.

When the TPS65233 is disabled (EN pin tied to ground) the device can still be updated via the I²C interface.

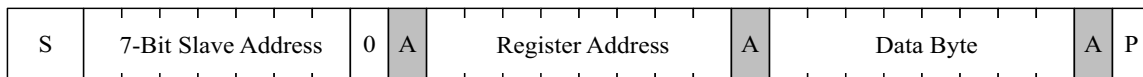

Figure 54. I²C Write Data Format

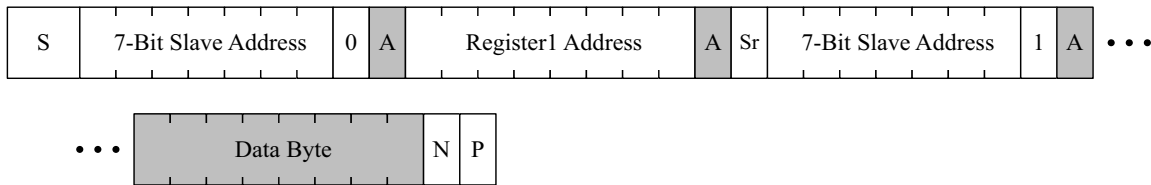

Figure 55. I²C Read Data Format

A: Acknowledge
 N: Not Acknowledge
 S: Start
 P: Stop
 Sr: Repeated Start

System Host (white box)
 Chip (grey box)

Register Description

Register descriptions are shown below tables.

Table 2. Control Register 1

	NO. OF BITS	ACCESS	NAME	DEFAULT VALUE	DESCRIPTION
Control Register	Bit 8				
address: 0x00H	Bit 7	R/W	I2C_CON	0	1: I ² C control enabled; 0: I ² C control disabled
	Bit 6	R/W		0	reserved
	Bit 5	R/W	TGATE	0	Tone Gate. Allows either the internal or external 22-kHz tone signals to be gated. 1: Tone Gate on, 0: Tone gate off
	Bit 4	R/W	TMODE	0	Tone mode. Select between the use of an external 22-kHz or internal 22-kHz signal. 1: internal; 0: external
	Bit 3	R/W	EN	1	LNB output voltage Enable 1: output enabled; 0: output disabled
Bit 1	Bit 2	R/W	VSEL2	0	See Table 3 for output voltage selection
	R/W	VSEL1	0		
	Bit 0	R/W			

Table 3. Voltage Selection Bits

VSEL2	VSEL1	VSEL0	LNB(V)
0	0	0	13
0	0	1	13.4
0	1	0	13.8
0	1	1	14.2
1	0	0	18
1	0	1	18.6
1	1	0	19.2
1	1	1	19.8

Table 4. Control Register 2

	NO. OF BITS	ACCESS	NAME	DEFAULT VALUE	DESCRIPTION
Control Register	Bit 8				
address: 0x01H	Bit 7	R/W			
	Bit 6	R/W			
	Bit 5	R/W			
	Bit 4	R/W	TONE_POS1	0	00: tone above Vout; 01: tone in the middle of Vout; 10: tone below Vout
	Bit 3	R/W	TONE_POS0	1	
	Bit 2	R/W	CL1	0	Current limit set bits
	Bit 1	R/W	CL0	0	
	Bit 0	R/W	CL_EXT	1	1: current limit set by external resistor; 0: current limit set by register

Some tone detection circuits in LNB is sensitive to the position of the tone on the output voltage. TPS65233 provides options to selection the position by setting the TONE_POS1 and TONE_POS0 bits, as illustrated below.



Option 1, TONE_POS1=0, TONE_POS0=0, Tone above VLNB

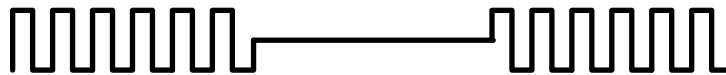

Option 2, TONE_POS1=0, TONE_POS0=1, Tone in the middle of VLNB



Option 2, TONE_POS1=1, TONE_POS0=0, Tone below VLNB

Figure 56. Tone Position Programmed by TONE_POS1, TONE_POS0 Bits

In addition to program the LDO's current continuously via an external resistor, internal registers also provide options to program the current limit. There are four options can be selected.

Table 5. Current Limit Selection Bits

CL1	CL0	CURRENT LIMIT (mA)
0	0	400
0	1	600
1	0	750
1	1	1000

TPS65233 has full range of diagnostic flags for operation and debug. If any of the flags are triggered, pin FAULT will be pulled low, sending an interrupt signal to processor. Processor then can read the status register to check the error conditions. Status bits are described as follow. Among these bits, TSD and OCP are different from others. Once TSD and OCP are set to "1", the Fault pin logic is latched to low, processor need to reset the bits in order to release the fault conditions. Other bits will change as conditions change without latch.

Table 6. Status Register 1

	NO. OF BITS	ACCESS	NAME	DEFAULT VALUE	DESCRIPTION
Status Register	Bit 8				
address: 0x02H	Bit 7				
	Bit 6	R	T125	0	1: if die temperature T>125°C; 0: if die temperature T<125°C;
	Bit 5	R	LDO_ON	0	1: internal LDO is turned on and boost converter is on; 0: Internal LDO is turned off but boost converter is on
	Bit 4	R		0	reserved
	Bit 3	R	TSD	0	1: thermal shutdown occurs; 0: thermal shutdown does not occur. FAULT pin pull low and latch, I ² C master need to read and release
	Bit 2	R	OCP	0	Over current protection. If over current conditions last for more than 48ms. 1: over current protection triggered. 0: over current protection conditions released. FAULT pin pull low and latch, I ² C master need to read and release
	Bit 1	R	CABLE_GOOD	0	Cable connection good. 1: output current above 50 mA; 0: output current less than 50 mA.
	Bit 0	R	VOUT_GOOD	0	LNB output voltage in range. 1: in range; 0: out of range

Layout Recommendation

TPS65233 is designed to layout in a 2-layer PCB. The following illustration shows the recommended layout practice. It's critical to make sure the GND of input cap, output cap and the boost converter are connected at one point at same layer as shown below. PGND and AGND are in different region. They are connected to thermal pad. Other components are connected AGND.

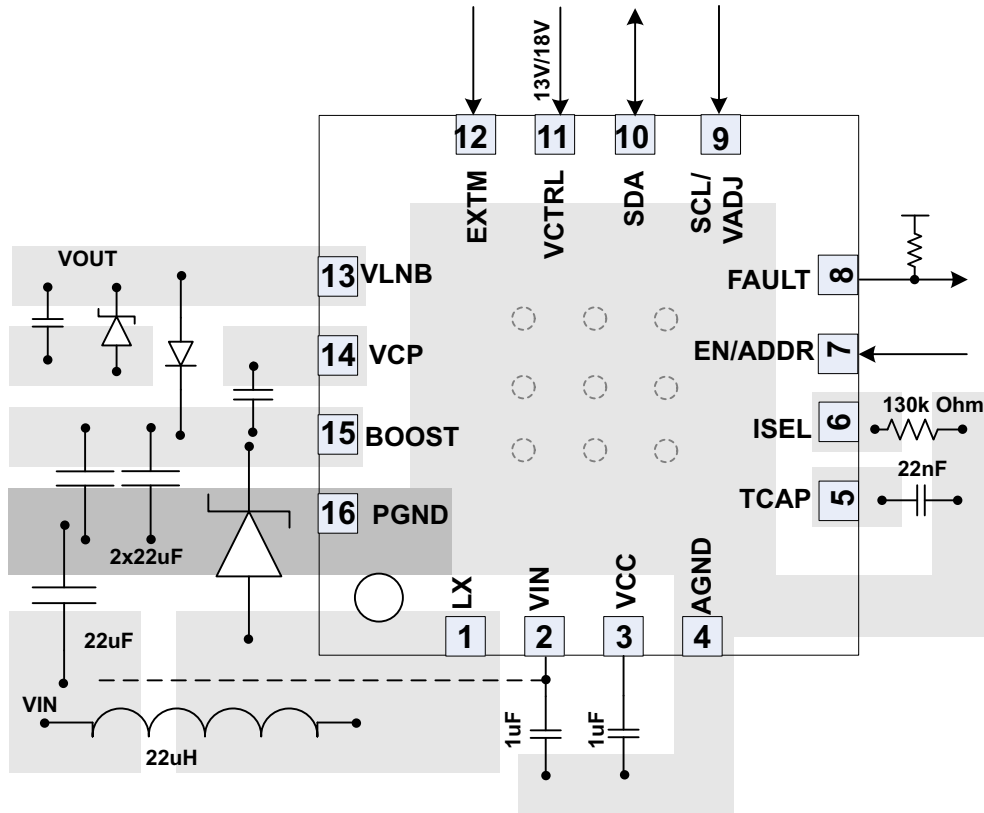

Figure 57. 2-Layer PCB Layout

PACKAGING INFORMATION

Orderable Device	Status (1)	Package Type	Package Drawing	Pins	Package Qty	Eco Plan (2)	Lead finish/ Ball material (6)	MSL Peak Temp (3)	Op Temp (°C)	Device Marking (4/5)	Samples
TPS65233RTER	ACTIVE	WQFN	RTE	16	3000	RoHS & Green	NIPDAU	Level-1-260C-UNLIM	-40 to 85	65233	Samples
TPS65233RTET	ACTIVE	WQFN	RTE	16	250	RoHS & Green	NIPDAU	Level-1-260C-UNLIM	-40 to 85	65233	Samples

(1) The marketing status values are defined as follows:

ACTIVE: Product device recommended for new designs.

LIFEBUY: TI has announced that the device will be discontinued, and a lifetime-buy period is in effect.

NRND: Not recommended for new designs. Device is in production to support existing customers, but TI does not recommend using this part in a new design.

PREVIEW: Device has been announced but is not in production. Samples may or may not be available.

OBSOLETE: TI has discontinued the production of the device.

(2) **RoHS:** TI defines "RoHS" to mean semiconductor products that are compliant with the current EU RoHS requirements for all 10 RoHS substances, including the requirement that RoHS substance do not exceed 0.1% by weight in homogeneous materials. Where designed to be soldered at high temperatures, "RoHS" products are suitable for use in specified lead-free processes. TI may reference these types of products as "Pb-Free".

RoHS Exempt: TI defines "RoHS Exempt" to mean products that contain lead but are compliant with EU RoHS pursuant to a specific EU RoHS exemption.

Green: TI defines "Green" to mean the content of Chlorine (Cl) and Bromine (Br) based flame retardants meet JS709B low halogen requirements of <=1000ppm threshold. Antimony trioxide based flame retardants must also meet the <=1000ppm threshold requirement.

(3) MSL, Peak Temp. - The Moisture Sensitivity Level rating according to the JEDEC industry standard classifications, and peak solder temperature.

(4) There may be additional marking, which relates to the logo, the lot trace code information, or the environmental category on the device.

(5) Multiple Device Markings will be inside parentheses. Only one Device Marking contained in parentheses and separated by a "~" will appear on a device. If a line is indented then it is a continuation of the previous line and the two combined represent the entire Device Marking for that device.

(6) Lead finish/Ball material - Orderable Devices may have multiple material finish options. Finish options are separated by a vertical ruled line. Lead finish/Ball material values may wrap to two lines if the finish value exceeds the maximum column width.

Important Information and Disclaimer:The information provided on this page represents TI's knowledge and belief as of the date that it is provided. TI bases its knowledge and belief on information provided by third parties, and makes no representation or warranty as to the accuracy of such information. Efforts are underway to better integrate information from third parties. TI has taken and continues to take reasonable steps to provide representative and accurate information but may not have conducted destructive testing or chemical analysis on incoming materials and chemicals. TI and TI suppliers consider certain information to be proprietary, and thus CAS numbers and other limited information may not be available for release.

In no event shall TI's liability arising out of such information exceed the total purchase price of the TI part(s) at issue in this document sold by TI to Customer on an annual basis.

TAPE AND REEL INFORMATION

QUADRANT ASSIGNMENTS FOR PIN 1 ORIENTATION IN TAPE

*All dimensions are nominal

Device	Package Type	Package Drawing	Pins	SPQ	Reel Diameter (mm)	Reel Width W1 (mm)	A0 (mm)	B0 (mm)	K0 (mm)	P1 (mm)	W (mm)	Pin1 Quadrant
TPS65233RTER	WQFN	RTE	16	3000	330.0	12.4	3.3	3.3	1.1	8.0	12.0	Q2
TPS65233RTER	WQFN	RTE	16	3000	330.0	12.4	3.3	3.3	1.1	8.0	12.0	Q2
TPS65233RTET	WQFN	RTE	16	250	180.0	12.4	3.3	3.3	1.1	8.0	12.0	Q2
TPS65233RTET	WQFN	RTE	16	250	180.0	12.4	3.3	3.3	1.1	8.0	12.0	Q2

TAPE AND REEL BOX DIMENSIONS

*All dimensions are nominal

Device	Package Type	Package Drawing	Pins	SPQ	Length (mm)	Width (mm)	Height (mm)
TPS65233RTER	WQFN	RTE	16	3000	367.0	367.0	35.0
TPS65233RTER	WQFN	RTE	16	3000	335.0	335.0	25.0
TPS65233RTET	WQFN	RTE	16	250	182.0	182.0	20.0
TPS65233RTET	WQFN	RTE	16	250	210.0	185.0	35.0

GENERIC PACKAGE VIEW

RTE 16

WQFN - 0.8 mm max height

3 x 3, 0.5 mm pitch

PLASTIC QUAD FLATPACK - NO LEAD

This image is a representation of the package family, actual package may vary.
Refer to the product data sheet for package details.



4225944/A



SIDE WALL METAL THICKNESS DIM A	
OPTION 1	OPTION 2
0.1	0.2

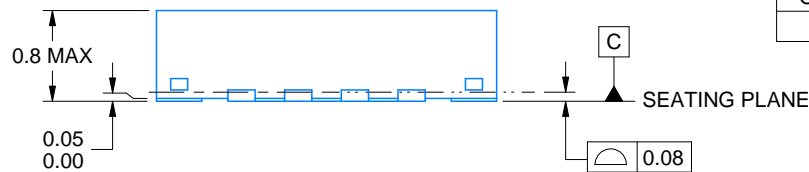

4219117/B 04/2022

NOTES:

1. All linear dimensions are in millimeters. Any dimensions in parenthesis are for reference only. Dimensioning and tolerancing per ASME Y14.5M.
2. This drawing is subject to change without notice.
3. The package thermal pad must be soldered to the printed circuit board for thermal and mechanical performance.

EXAMPLE BOARD LAYOUT

RTE0016C

WQFN - 0.8 mm max height

PLASTIC QUAD FLATPACK - NO LEAD

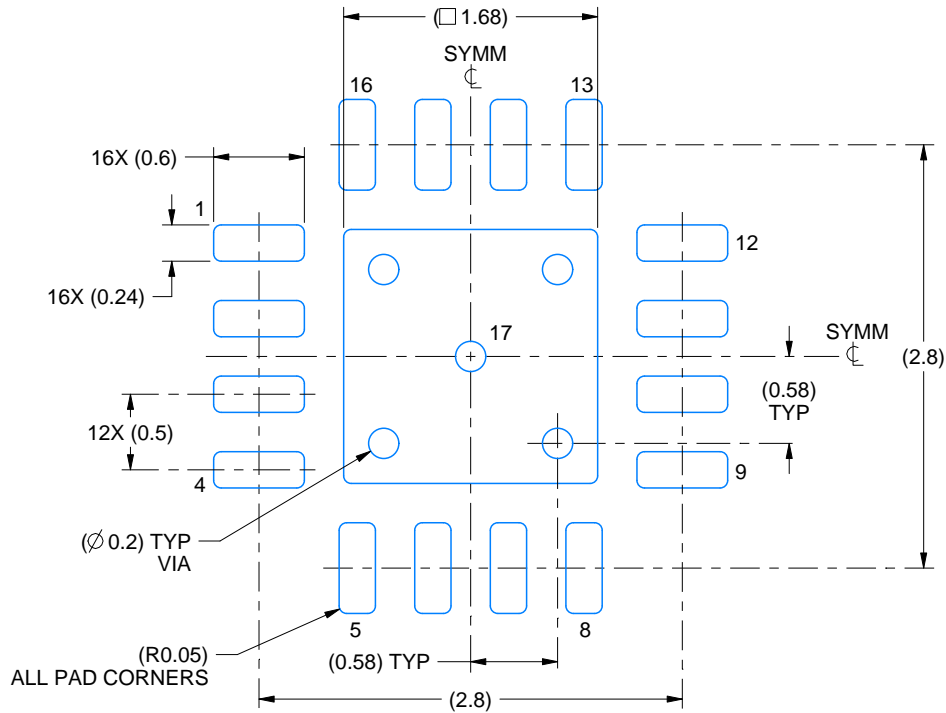

LAND PATTERN EXAMPLE
EXPOSED METAL SHOWN
SCALE:20X

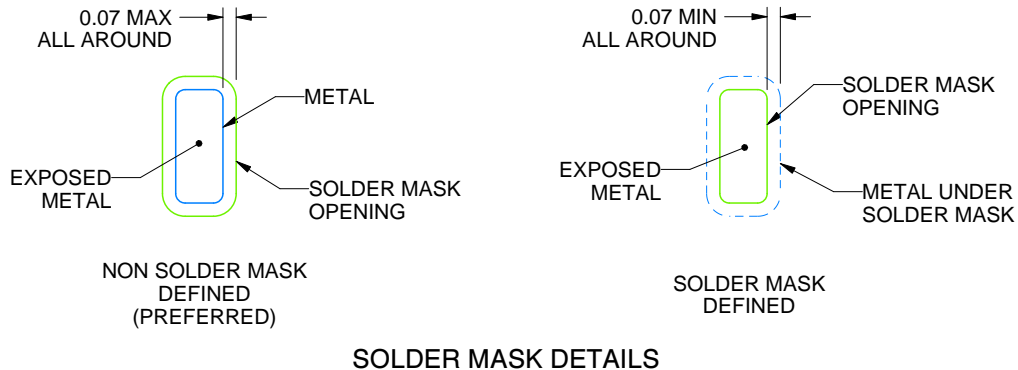

SOLDER MASK DETAILS

4219117/B 04/2022

NOTES: (continued)

- This package is designed to be soldered to a thermal pad on the board. For more information, see Texas Instruments literature number SLUA271 (www.ti.com/lit/sl原因271).
- Vias are optional depending on application, refer to device data sheet. If any vias are implemented, refer to their locations shown on this view. It is recommended that vias under paste be filled, plugged or tented.

EXAMPLE STENCIL DESIGN

RTE0016C

WQFN - 0.8 mm max height

PLASTIC QUAD FLATPACK - NO LEAD



SOLDER PASTE EXAMPLE
BASED ON 0.125 mm THICK STENCIL

EXPOSED PAD 17:
85% PRINTED SOLDER COVERAGE BY AREA UNDER PACKAGE
SCALE:25X

4219117/B 04/2022

NOTES: (continued)

6. Laser cutting apertures with trapezoidal walls and rounded corners may offer better paste release. IPC-7525 may have alternate design recommendations.

IMPORTANT NOTICE AND DISCLAIMER

TI PROVIDES TECHNICAL AND RELIABILITY DATA (INCLUDING DATA SHEETS), DESIGN RESOURCES (INCLUDING REFERENCE DESIGNS), APPLICATION OR OTHER DESIGN ADVICE, WEB TOOLS, SAFETY INFORMATION, AND OTHER RESOURCES "AS IS" AND WITH ALL FAULTS, AND DISCLAIMS ALL WARRANTIES, EXPRESS AND IMPLIED, INCLUDING WITHOUT LIMITATION ANY IMPLIED WARRANTIES OF MERCHANTABILITY, FITNESS FOR A PARTICULAR PURPOSE OR NON-INFRINGEMENT OF THIRD PARTY INTELLECTUAL PROPERTY RIGHTS.

These resources are intended for skilled developers designing with TI products. You are solely responsible for (1) selecting the appropriate TI products for your application, (2) designing, validating and testing your application, and (3) ensuring your application meets applicable standards, and any other safety, security, regulatory or other requirements.

These resources are subject to change without notice. TI grants you permission to use these resources only for development of an application that uses the TI products described in the resource. Other reproduction and display of these resources is prohibited. No license is granted to any other TI intellectual property right or to any third party intellectual property right. TI disclaims responsibility for, and you will fully indemnify TI and its representatives against, any claims, damages, costs, losses, and liabilities arising out of your use of these resources.

TI's products are provided subject to [TI's Terms of Sale](#) or other applicable terms available either on [ti.com](https://www.ti.com) or provided in conjunction with such TI products. TI's provision of these resources does not expand or otherwise alter TI's applicable warranties or warranty disclaimers for TI products.

TI objects to and rejects any additional or different terms you may have proposed.

Mailing Address: Texas Instruments, Post Office Box 655303, Dallas, Texas 75265
Copyright © 2023, Texas Instruments Incorporated