

## 2A Dual Channel Synchronous Step-Down Switcher with Integrated FET

 Check for Samples: [TPS54294](#)

### FEATURES

- **D-CAP2™ Control Mode**
  - Fast Transient Response
  - No External Parts Required For Loop Compensation
  - Compatible with Ceramic Output Capacitors
- **Wide Input Voltage Range : 4.5 V to 18 V**
- **Output Voltage Range : 0.76V to 7.0V**
- **Highly Efficient Integrated FETs Optimized for Low Duty Cycle Applications**
  - 150 mΩ (High Side) and 100 mΩ (Low Side)
- **High Initial Reference Accuracy**
- **Low-Side  $r_{DS(on)}$  Loss-Less Current Sensing**
- **Fixed Soft Start : 1.0ms**
- **Non-Sinking Pre-Biased Soft Start**
- **Powergood**
- **700 kHz Switching Frequency**
- **Cycle-by-Cycle Over-Current Limit Control**
- **OCL/OVP/UVP/UVLO/TSD Protections**
- **Adaptive Gate Drivers with Integrated Boost PMOS Switch**
- **OCP Constant Due To Thermally Compensated  $r_{DS(on)}$  with 4000ppm/°C**
- **16-Pin HTSSOP, 16-Pin VQFN**
- **Auto-Skip Eco-mode™ for High Efficiency at Light Load**

### APPLICATIONS

- **Point-of-Load Regulation in Low Power Systems for Wide Range of Applications**
  - Digital TV Power Supply
  - Networking Home Terminal
  - Digital Set Top Box (STB)
  - DVD Player/Recorder
  - Gaming Consoles and Other

### DESCRIPTION

The TPS54294 is a dual, adaptive on-time D-CAP2™ mode synchronous buck converter. The TPS54294 enables system designers to complete the suite of various end equipment's power bus regulators with a cost effective, low component count, and low standby current solution. The main control loops of the TPS54294 use the D-CAP2™ mode control which provides a very fast transient response with no external compensation components. The adaptive on-time control supports seamless transition between PWM mode at higher load conditions and Eco-mode™ operation at light loads. Eco-mode™ allows the TPS54294 to maintain high efficiency during lighter load conditions. The TPS54294 is able to adapt to both low equivalent series resistance (ESR) output capacitors such as POSCAP or SP-CAP, and ultra-low ESR, ceramic capacitors. The device provides convenient and efficient operation with input voltages from 4.5V to 18V.

The TPS54294 is available in a 4.4mm × 5.0mm 16-pin TSSOP (PWP) package, and 4mm × 4mm 16-pin VQFN (RSA) package specified for an ambient temperature range from –40°C to 85°C.

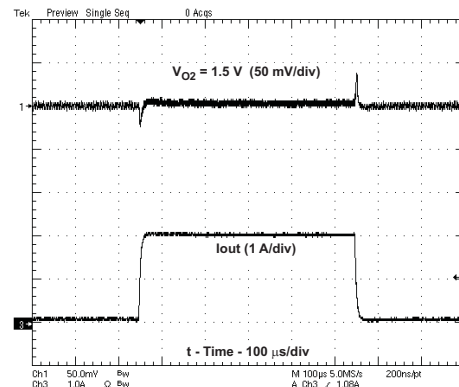
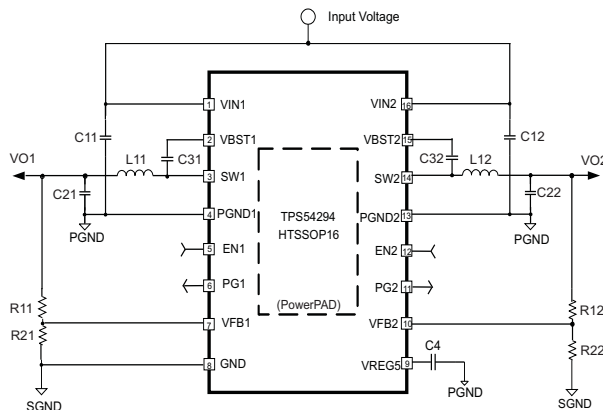

Please be aware that an important notice concerning availability, standard warranty, and use in critical applications of Texas Instruments semiconductor products and disclaimers thereto appears at the end of this data sheet.

D-CAP2, Eco-mode, Eco-Mode, SWIFT are trademarks of Texas Instruments.



These devices have limited built-in ESD protection. The leads should be shorted together or the device placed in conductive foam during storage or handling to prevent electrostatic damage to the MOS gates.

### ORDERING INFORMATION<sup>(1)</sup>

T <sub>A</sub>	PACKAGE	ORDERING PART NUMBER	PINS	OUTPUT SUPPLY
-40°C to 85°C	PWP	TPS54294PWPR	16	Tape-and-Reel
		TPS54294PWP		Tube
	RSA	TPS54294RSAR	16	Tape-and-Reel
		TPS54294RSAT		

(1) For the most current package and ordering information, see the Package Option Addendum at the end of this document, or see the TI web site at [www.ti.com](http://www.ti.com)

### ABSOLUTE MAXIMUM RATINGS

over operating free-air temperature range (unless otherwise noted)<sup>(1)</sup> <sup>(2)</sup>

		VALUE	UNIT
Input voltage range	VIN1, VIN2, EN1, EN2	-0.3 to 20	V
	VBST1, VBST2	-0.3 to 26	
	VBST1, VBST2 (10ns transient)	-0.3 to 28	
	VBST1-SW1, VBST2-SW2	-0.3 to 6.5	
	VFB1, VFB2	-0.3 to 6.5	
	SW1, SW2	-2 to 20	
	SW1, SW2 (10ns transient)	-3 to 22	
Output voltage range	VREG5, PG1, PG2	-0.3 to 6.5	V
	PGND1, PGND2	-0.3 to 0.3	
Electrostatic discharge	Human Body Model (HBM)	2	kV
	Charged Device Model (CDM)	500	V
T <sub>A</sub>	Operating ambient temperature range	-40 to 85	°C
T <sub>STG</sub>	Storage temperature range	-55 to 150	°C
T <sub>J</sub>	Junction temperature range	-40 to 150	°C

- (1) Stresses beyond those listed under "absolute maximum ratings" may cause permanent damage to the device. These are stress ratings only and functional operation of the device at these or any other conditions beyond those indicated under "recommended operating conditions" are not implied. Exposure to absolute-maximum-rated conditions for extended periods may affect device reliability.
- (2) All voltages are with respect to IC GND terminal.

### THERMAL INFORMATION

THERMAL METRIC <sup>(1)</sup>	TPS54294		UNITS
	PWP (16) PINS	RSA (16) PINS	
θ <sub>JA</sub> Junction-to-ambient thermal resistance	47.5	34.9	°C/W
θ <sub>JCtop</sub> Junction-to-case (top) thermal resistance	27.1	40.0	
θ <sub>JB</sub> Junction-to-board thermal resistance	20.8	11.8	
ψ <sub>JT</sub> Junction-to-top characterization parameter	1.0	0.7	
ψ <sub>JB</sub> Junction-to-board characterization parameter	20.6	11.8	
θ <sub>JCbot</sub> Junction-to-case (bottom) thermal resistance	2.7	3.3	

(1) For more information about traditional and new thermal metrics, see the *IC Package Thermal Metrics* application report, [SPRA953](http://SPRA953).

## RECOMMENDED OPERATING CONDITIONS

over operating free-air temperature range (unless otherwise noted)

		VALUES		UNIT
		MIN	MAX	
Supply input voltage range	VIN1, VIN2	4.5	18	V
Input voltage range	VBST1, VBST2	-0.1	24	V
	VBST1, VBST2 (10ns transient)	-0.1	27	
	VBST1–SW1, VBST2–SW2	-0.1	5.7	
	VFB1, VFB2	-0.1	5.7	
	EN1, EN2	-0.1	18	
	SW1, SW2	-1.0	18	
	SW1, SW2 (10ns transient)	-3	21	
Output voltage range	VREG5, PG1, PG2	-0.1	5.7	V
	PGND1, PGND2	-0.1	0.1	
	VO1, VO2	0.76	7.0	
T <sub>A</sub>	Operating free-air temperature	-40	85	°C
T <sub>J</sub>	Operating Junction Temperature	-40	150	°C

## ELECTRICAL CHARACTERISTICS<sup>(1)</sup>

over recommended free-air temperature range, VIN = 12 V (unless otherwise noted)

PARAMETER		CONDITIONS	MIN	TYP	MAX	UNIT
<b>SUPPLY CURRENT</b>						
I <sub>IN</sub>	VIN supply current	EN1 = EN2 = 5 V, VFB1 = VFB2 = 0.8 V		1300	2500	μA
I <sub>VINSDN</sub>	VIN shutdown current	EN1 = EN2 = 0 V		80	200	μA
<b>FEEDBACK VOLTAGE</b>						
V <sub>VFBTHLx</sub>	VFBx threshold voltage	CH1 = 3.3 V, CH2 = 1.5 V	758	765	773	mV
TC <sub>VFBx</sub>	Temperature coefficient	On the basis of 25°C <sup>(2)</sup>	-115		115	ppm/°C
I <sub>VFBx</sub>	VFB Input Current	VFBx = 0.8 V	-0.35	0.2	0.35	μA
<b>VREG5 OUTPUT</b>						
V <sub>VREG5</sub>	VREG5 output voltage	6 V < VIN1 < 18 V, I <sub>VREG</sub> = 5 mA		5.5		V
I <sub>VREG5</sub>	Output current	VIN1 = 6 V, VREG5 = 4 V <sup>(2)</sup>		75		mA
<b>MOSFETs</b>						
r <sub>DS(on)H</sub>	High side switch resistance	VBSTx-SWx = 5.5 V <sup>(2)</sup>		150		mΩ
r <sub>DS(on)L</sub>	Low side switch resistance <sup>(2)</sup>			100		mΩ
<b>ON-TIME TIMER CONTROL</b>						
T <sub>ON1</sub>	SW1 On Time	SW1 = 12 V, VO1 = 1.2 V		165		ns
T <sub>ON2</sub>	SW2 On Time	SW2 = 12 V, VO2 = 1.2 V		165		ns
T <sub>OFF1</sub>	SW1 Min off time	VFB1 = 0.7 V <sup>(2)</sup>		220		ns
T <sub>OFF2</sub>	SW2 Min off time	VFB2 = 0.7 V <sup>(2)</sup>		220		ns
<b>SOFT START</b>						
T <sub>SS</sub>	Soft-start time	Internal soft-start time		1.0		ms

(1) x means either 1 or 2, that is, VFBx means VFB1 or VFB2.

(2) Specified by design. Not production tested.

**ELECTRICAL CHARACTERISTICS (continued)**

over recommended free-air temperature range, VIN = 12 V (unless otherwise noted)

PARAMETER		CONDITIONS	MIN	TYP	MAX	UNIT	
<b>POWER GOOD</b>							
V <sub>PGTH</sub>	PGx threshold	PG from lower VOx (going high)	84%				
		PG from higher VOx (going low)	116%				
R <sub>PG</sub>	PGx pull-down resistance	VPGx = 0.5 V	50	75	110	Ω	
T <sub>PGDLY</sub>	PGx delay time	Delay for PGx going high	1.5			ms	
		Delay for PGx going low	2			μs	
T <sub>PGCOMPSS</sub>	PGx comparator start-up delay	PGx comparator wake-up delay	1.5			ms	
<b>UVLO</b>							
V <sub>UVREG5</sub>	VREG5 UVLO threshold	VREG5 rising	3.83			V	
		Hysteresis	0.6				
<b>LOGIC THRESHOLDS</b>							
V <sub>ENH</sub>	ENx H-level threshold voltage		2.0			V	
V <sub>ENL</sub>	ENx L-level threshold voltage		0.4			V	
R <sub>ENx_IN</sub>	ENx input resistance	ENx = 12 V	225	450	900	kΩ	
<b>CURRENT LIMITS</b>							
I <sub>OCL</sub>	Current limit	L <sub>OUT</sub> = 2.2 μH <sup>(3)</sup>	2.7	3.9	4.5	A	
<b>OUTPUT UNDERVOLTAGE AND OVERVOLTAGE PROTECTION (UVP, OVP)</b>							
V <sub>OVP</sub>	Output OVP trip threshold	measured on VFBx	115%	120%	125%		
T <sub>OVPDEL</sub>	Output OVP prop delay		3			10	μs
V <sub>UVP</sub>	Output UVP trip threshold	measured on VFBx	63%	68%	73%		
T <sub>UVPDEL</sub>	Output UVP delay time		1.5			ms	
T <sub>UVPEN</sub>	Output UVP enable delay		1.5			ms	
<b>THERMAL SHUTDOWN</b>							
T <sub>SD</sub>	Thermal shutdown threshold	Shutdown temperature <sup>(3)</sup>	155			°C	
		Hysteresis <sup>(3)</sup>	25				

(3) Specified by design. Not production tested.

DEVICE INFORMATION

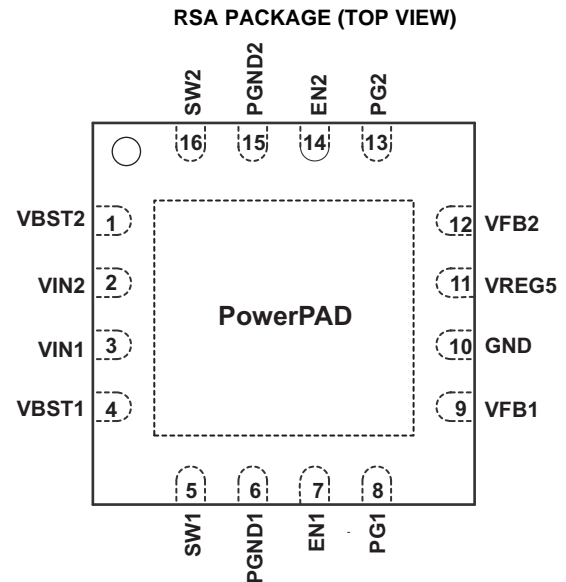
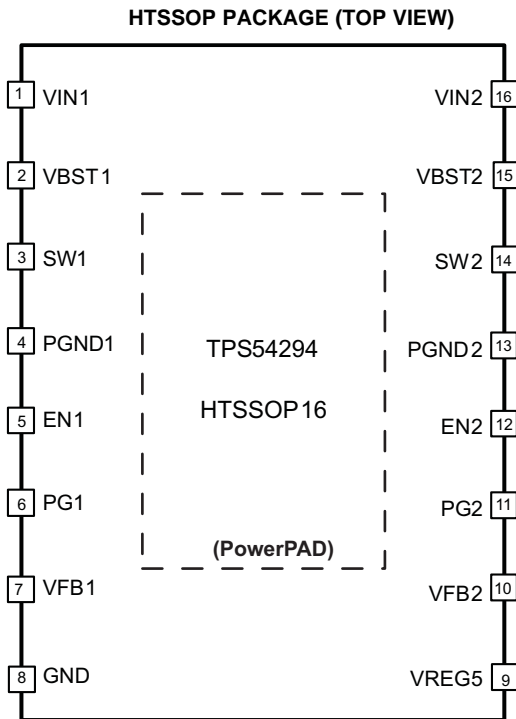

PIN FUNCTIONS<sup>(1)</sup>

NAME	PIN NUMBER		I/O	DESCRIPTION
	NUMBER			
	PWP	RSA		
VIN1, VIN2	1, 16	3, 2	I	Power inputs and connects to both high side NFET drains. Supply Input for 5.5V linear regulator.
VBST1, VBST2	2, 15	4, 1	I	Supply input for high-side NFET gate drive circuit. Connect 0.1µF ceramic capacitor between VBSTx and SWx pins. An internal diode is connected between VREG5 and VBSTx
SW1, SW2	3, 14	5, 16	I/O	Switch node connections for both the high-side NFETs and low-side NFETs. Input of current comparator.
PGND1, PGND2	4, 13	6, 15	I/O	Ground returns for low-side MOSFETs. Input of current comparator.
EN1, EN2	5, 12	7, 14	I	Enable. Pull High to enable according converter.
PG1, PG2	6, 11	8, 13	O	Open drain power good output. Low means the output voltage of the corresponding output is out of regulation.
VFB1, VFB2	7, 10	9, 12	I	D-CAP2 feedback inputs. Connect to output voltage with resistor divider.
GND	8	10	I/O	Signal GND. Connect sensitive SSx and VFBx returns to GND at a single point.
VREG5	9	11	O	Output of 5.5V linear regulator. Bypass to GND with a high-quality ceramic capacitor of at least 1.0 µF. VREG5 is active when VIN1 is added .
Exposed Thermal Pad	Back side	Back side	I/O	Thermal pad of the package. Must be soldered to achieve appropriate dissipation. Must be connected to GND.

(1) x means either 1 or 2, e.g. VFBx means VFB1 or VFB2.

FUNCTIONAL BLOCK DIAGRAM

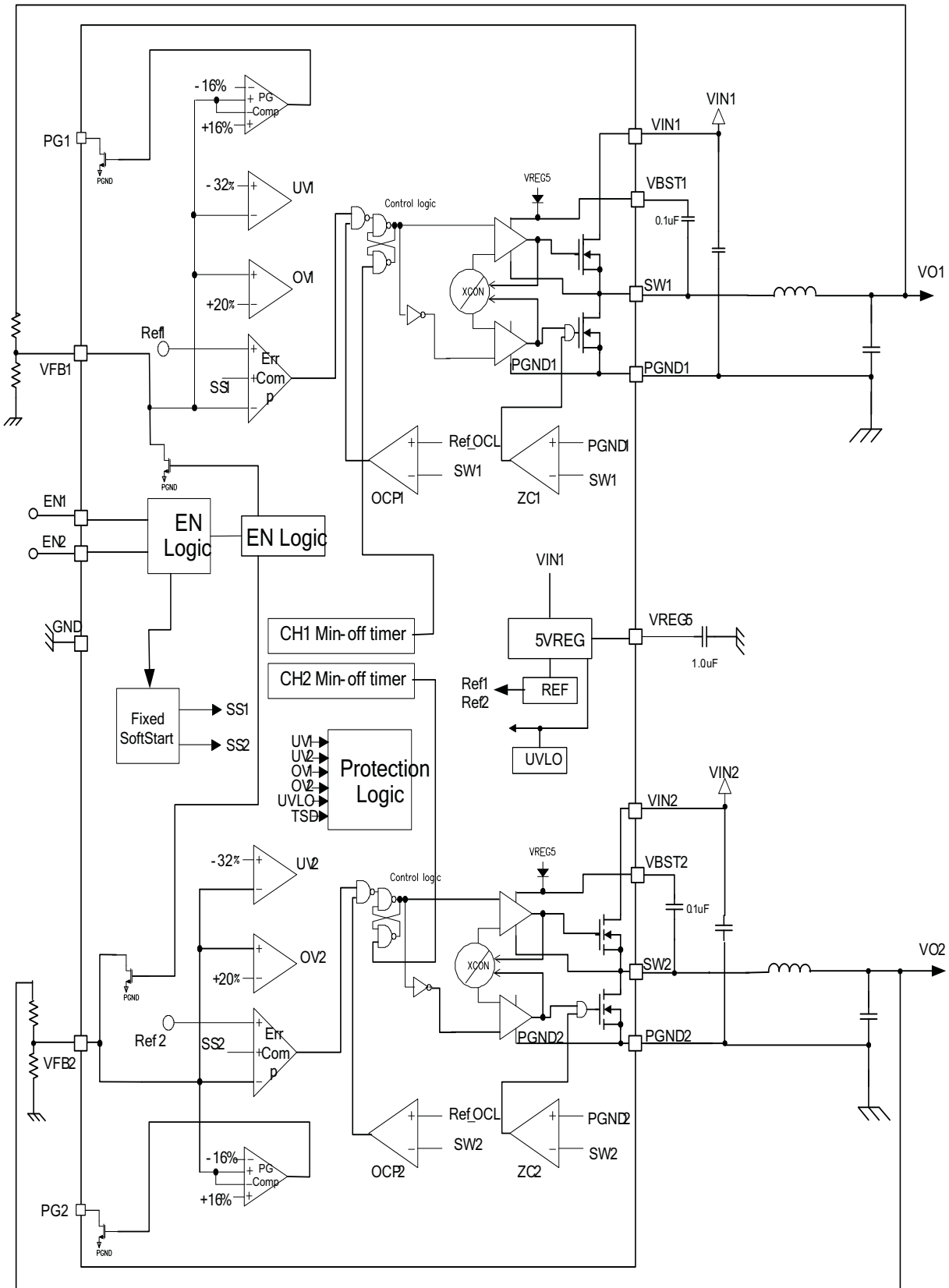

## OVERVIEW

The TPS54294 is a 2A/2A dual synchronous step-down (buck) converter with two integrated N-channel MOSFETs for each channel. It operates using D-CAP2™ control mode. The fast transient response of D-CAP2™ control reduces the required output capacitance to meet a specific level of performance. Proprietary internal circuitry allows the use of low ESR output capacitors including ceramic and special polymer types.

## DETAILED DESCRIPTION

### PWM Operation

The main control loop of the TPS54294 is an adaptive on-time pulse width modulation (PWM) controller that supports a proprietary D-CAP2™ control mode. D-CAP2™ control combines constant on-time control with an internal compensation circuit for pseudo-fixed frequency and low external component count configuration with both low ESR and ceramic output capacitors. It is stable even with virtually no ripple at the output.

At the beginning of each cycle, the high-side MOSFET is turned on. This MOSFET is turned off when the internal timer expires. This timer is set by the converter's input voltage, VINx, and the output voltage, VOx, to maintain a pseudo-fixed frequency over the input voltage range hence it is called adaptive on-time control. The timer is reset and the high-side MOSFET is turned on again when the feedback voltage falls below the nominal output voltage. An internal ramp is added to the reference voltage to simulate output voltage ripple, eliminating the need for ESR induced output ripple from D-CAP™ control.

### PWM Frequency and Adaptive On-Time Control

TPS54294 uses an adaptive on-time control scheme and does not have a dedicated on board oscillator. The TPS54294 runs with a pseudo-fixed frequency of 700 kHz by using the input voltage and output voltage to set the on-time timer. The on-time is inversely proportional to the input voltage and proportional to the output voltage, therefore, when the duty ratio is VOx/VINx, the frequency is constant.

### Auto-Skip Eco-Mode™ Control

The TPS54294 is designed with Auto-Skip Eco-mode™ to increase light load efficiency. As the output current decreases from heavy load condition, the inductor current also reduces and eventually comes to the point where its ripple valley touches the zero level, which is the boundary between continuous conduction and discontinuous conduction modes. The rectifying MOSFET is turned off when zero inductor current is detected. As the load current further decreases the converter runs into discontinuous conduction mode. The on-time is kept almost half as it was in the continuous conduction mode because it takes longer to discharge the output capacitor with smaller load current to the nominal output voltage. The transition point to the light load operation IOx(LL) current can be estimated with Equation 1 with 700-kHz used as fSW.

$$I_{Ox(LL)} = \frac{1}{2 \times L1x \times f_{SW}} \times \frac{(V_{INx} - V_{Ox}) \times V_{Ox}}{V_{INx}} \quad (1)$$

### Soft Start and Pre-Biased Soft Start

The TPS54294 has an internal, 1.0ms, soft-start for each channel. When the ENx pin becomes high, an internal DAC begins ramping up the reference voltage to the PWM comparator. Smooth control of the output voltage is maintained during start up.

The TPS54294 contains a unique circuit to prevent current from being pulled from the output during startup if the output is pre-biased. When the soft-start commands a voltage higher than the pre-bias level (internal soft start becomes greater than internal feedback voltage, VFBx), the controller slowly activates synchronous rectification by starting the first low side FET gate driver pulses with a narrow on-time. It then increments that on-time on a cycle-by-cycle basis until it coincides with the time dictated by (1-D), where D is the duty cycle of the converter. This scheme prevents the initial sinking of the pre-biased output, and ensures that the output voltage (VOx) starts and ramps up smoothly into regulation from pre-biased startup to normal mode operation.

## POWERGOOD

The TPS54294 has power-good outputs that are measured on VFBx. The power-good function is activated after the soft-start has finished. If the output voltage is within 16% of the target voltage, the internal comparator detects the power good state and the power good signal becomes high after 1.5ms delay. During start-up, this internal delay starts after 1.5ms of the UVP Enable delay time to avoid a glitch of the power-good signal. If the feedback voltage goes outside of  $\pm 16\%$  of the target value, the power-good signal becomes low after 2 $\mu$ s.

## Over-Current Protection

The output over-current protection (OCP) is implemented using a cycle-by-cycle valley detection control circuit. The switch current is monitored by measuring the low-side FET switch voltage between the SWx and PGNDx pins. This voltage is proportional to the switch current and the on-resistance of the FET. To improve the measurement accuracy, the voltage sensing is temperature compensated.

During the on-time of the high-side FET switch, the switch current increases at a linear rate determined by VINx, VOx, the on-time and the output inductor value. During the on-time of the low-side FET switch, this current decreases linearly. The average value of the switch current is the load current  $I_{OUTx}$ . If the sensed voltage on the low-side FET is above the voltage proportional to the current limit, the converter keeps the low-side switch on until the measured voltage falls below the voltage corresponding to the current limit and a new switching cycle begins. In subsequent switching cycles, the on-time is set to the value determined for CCM and the current is monitored in the same manner.

Following are some important considerations for this type of over-current protection. The load current is one half of the peak-to-peak inductor current higher than the over-current threshold. Also when the current is being limited, the output voltage tends to fall as the demanded load current may be higher than the current available from the converter. When the over current condition is removed, the output voltage returns to the regulated value. This protection is non-latching.

## Over/Under Voltage Protection

TPS54294 monitors the resistor divided feedback voltage to detect over and under voltage. If the feedback voltage is higher than 120% of the reference voltage, the OVP comparator output goes high and the circuit latches both the high-side MOSFET driver and the low-side MOSFET driver off. When the feedback voltage is lower than 68% of the reference voltage, the UVP comparator output goes high and an internal UVP delay counter begins counting. After 1.5ms, TPS54294 latches OFF both the high-side MOSFET and the low-side MOSFET drivers. This function is enabled approximately 1.7 times the softstart time after power-on. The OVP and UVP latch off is reset when EN is toggled.

## UVLO Protection

Under-voltage lock out protection (UVLO) monitors the voltage of the  $V_{REG5}$  pin. When the  $V_{REG5}$  voltage is lower than the UVLO threshold, the TPS54294 shuts down. As soon as the voltage increases above the UVLO threshold, the converter starts again.

## Thermal Shutdown

TPS54294 monitors its temperature. If the temperature exceeds the threshold value (typically 155°C), the device shuts down. When the temperature falls below the threshold, the IC starts again.

When VIN1 starts up and VREG5 output voltage is below its nominal value, the thermal shutdown threshold is lower than 155°C. As long as VIN1 rises,  $T_J$  must be kept below 110°C.



### TYPICAL CHARACTERISTICS

One output is enabled unless otherwise noted.  $V_I = VIN1$  or  $VIN2$ .  
 $VIN = 12\text{ V}$ ,  $T_A = 25^\circ\text{C}$  (unless otherwise noted).

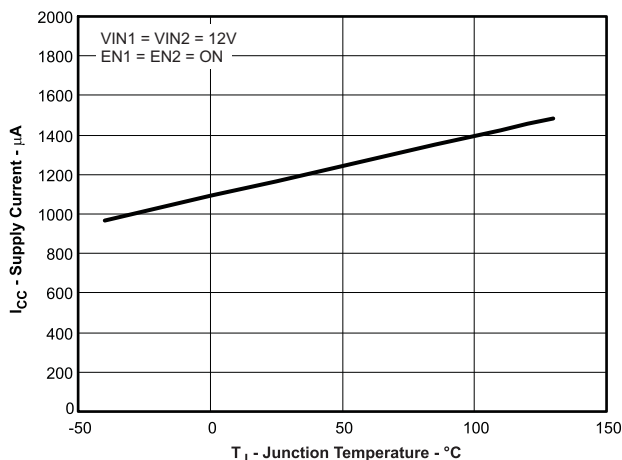

Figure 1. Input Current vs Junction Temperature

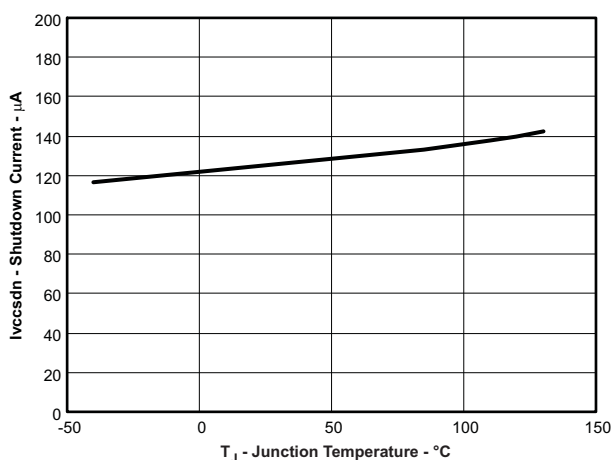

Figure 2. Input Shutdown Current vs Junction Temperature

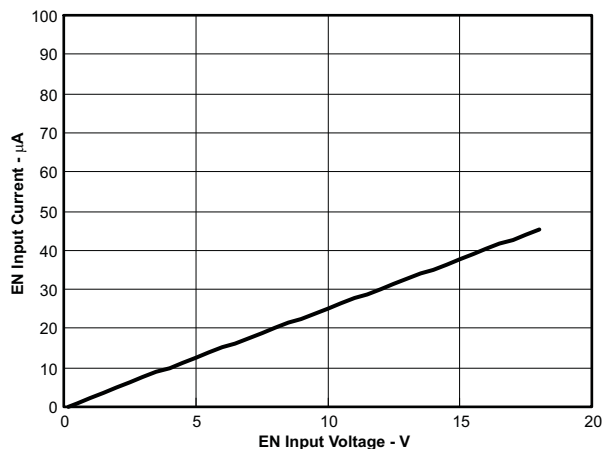

Figure 3. EN Current vs EN Voltage (VEN=12V)

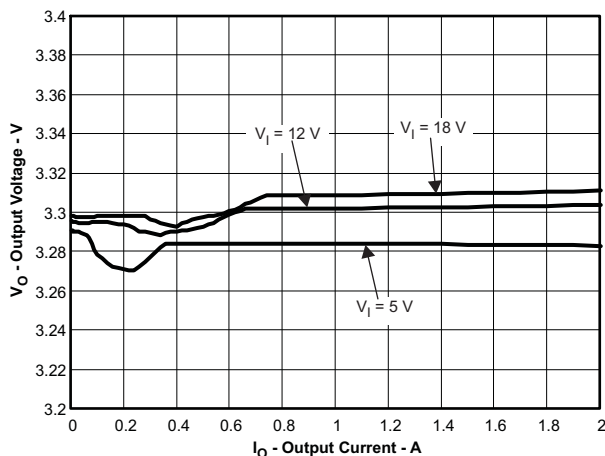

Figure 4. VO1=3.3V Output Voltage vs Output Current

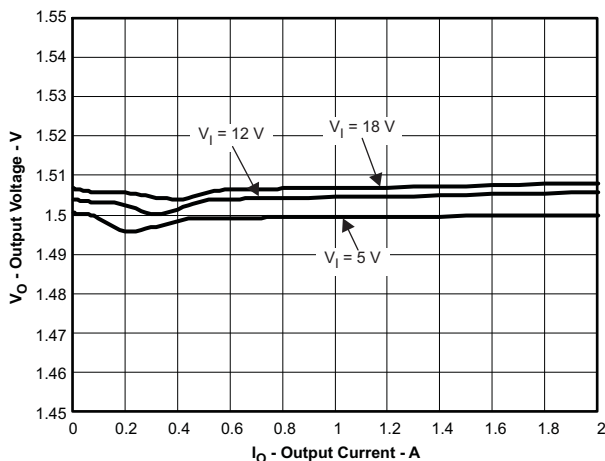

Figure 5. VO2=1.5V Output Voltage vs Output Current

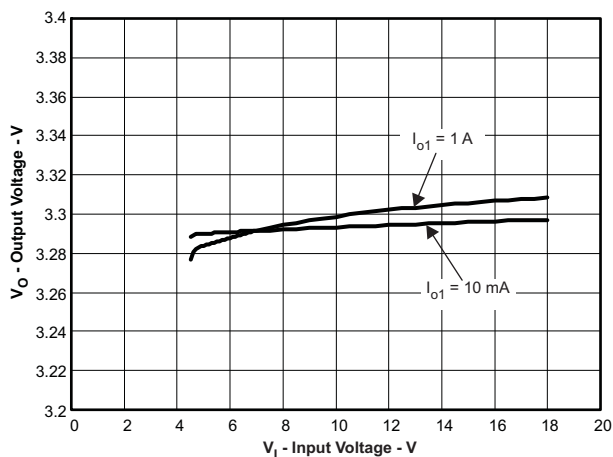

Figure 6. VO1=3.3V Output Voltage vs Input Voltage

### TYPICAL CHARACTERISTICS

One output is enabled unless otherwise noted. VI = VIN1 or VIN2.  
 VIN = 12 V, TA = 25°C (unless otherwise noted).

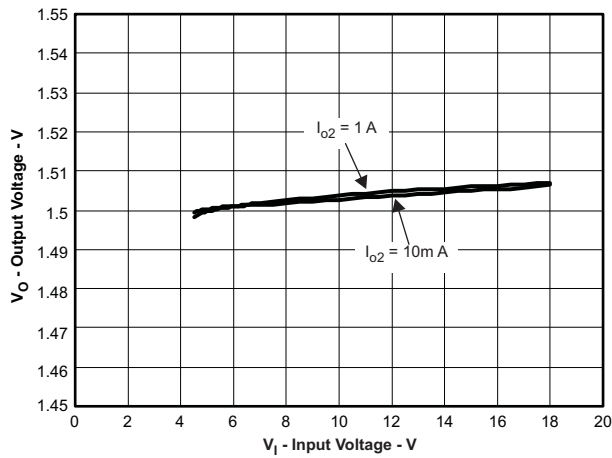

Figure 7. VO2=1.5V Output Voltage vs Input Voltage

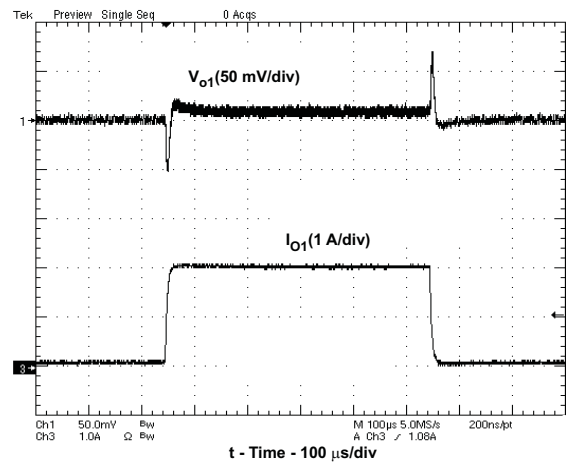

Figure 8. VO1=3.3V, 0A to 2A Load Transient Response

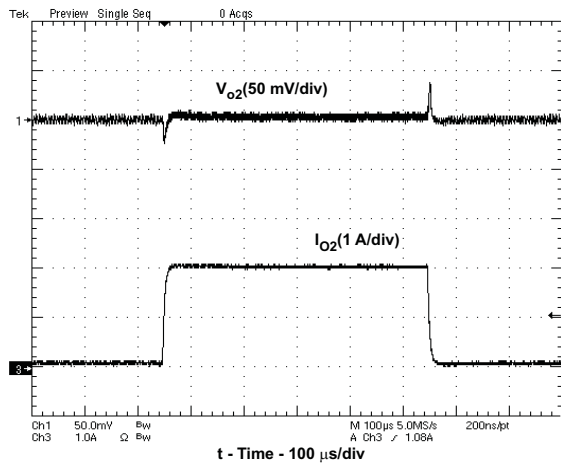

Figure 9. VO2=1.5V, 0A to 2A Load Transient Response

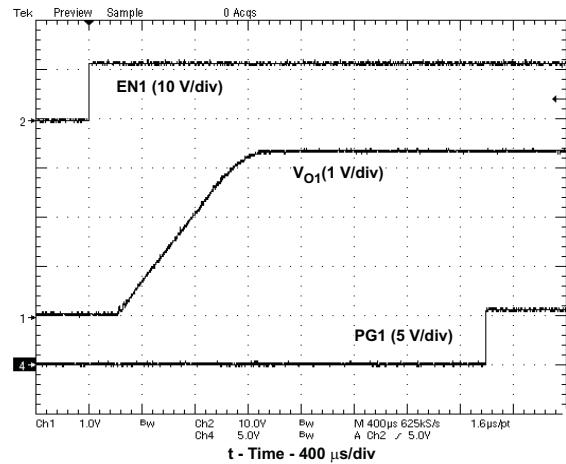

Figure 10. VO1=3.3V, SoftStart and Powergood

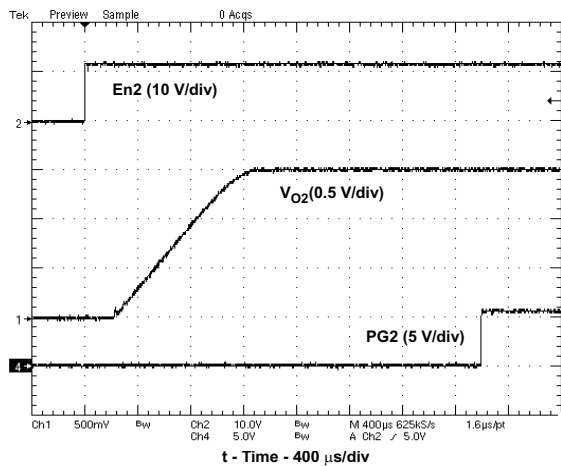

Figure 11. VO2=1.5V, SoftStart and Power Good

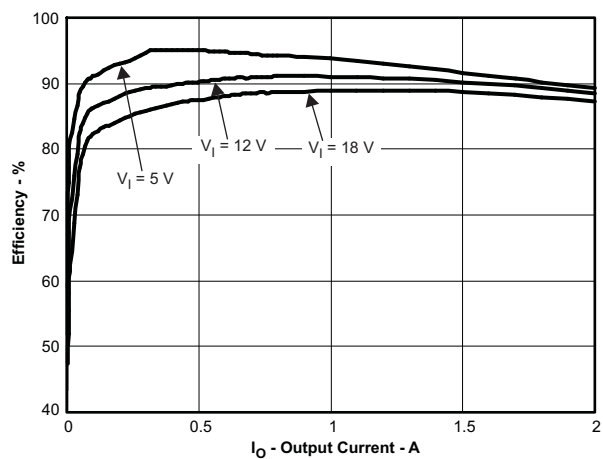

Figure 12. VO1=3.3V, Efficiency vs Output Current

**TYPICAL CHARACTERISTICS**

One output is enabled unless otherwise noted.  $V_I = V_{IN1}$  or  $V_{IN2}$ .  
 $V_{IN} = 12\text{ V}$ ,  $T_A = 25^\circ\text{C}$  (unless otherwise noted).

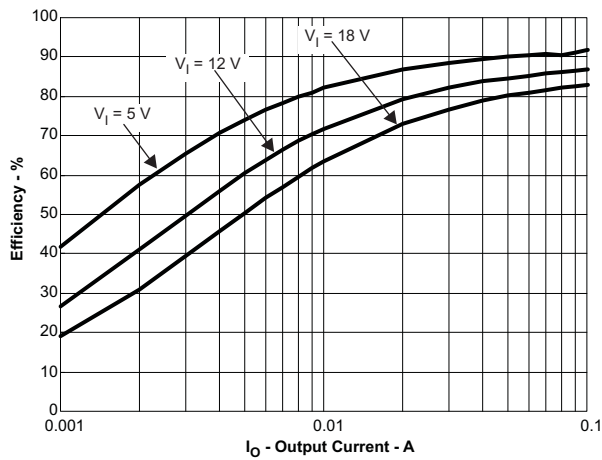

Figure 13.  $V_{O1}=3.3\text{V}$ , Efficiency vs Output Current

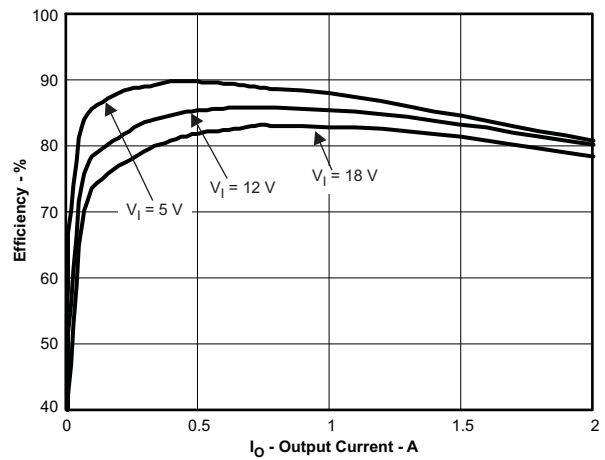

Figure 14.  $V_{O1}=1.5\text{V}$ , Efficiency vs Output Current

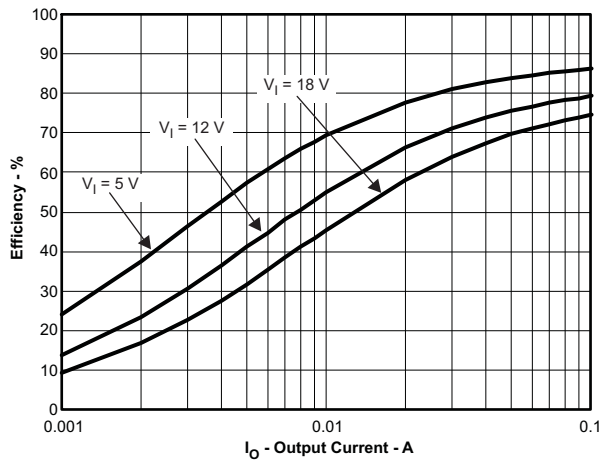

Figure 15.  $V_{O2}=1.5\text{V}$ , Efficiency vs Output Current

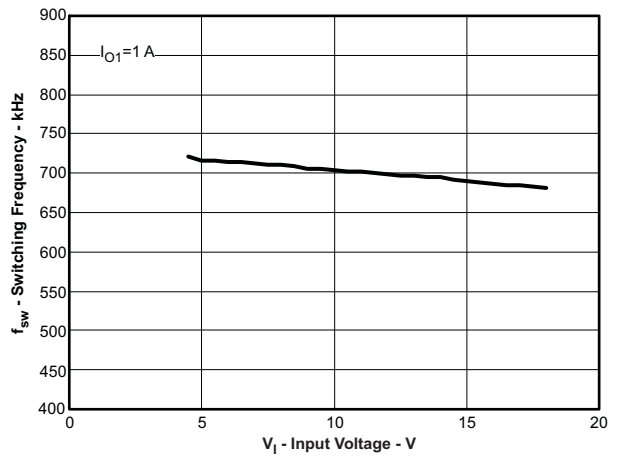

Figure 16.  $V_{O1}=3.3\text{V}$ , SW-frequency vs Input Voltage

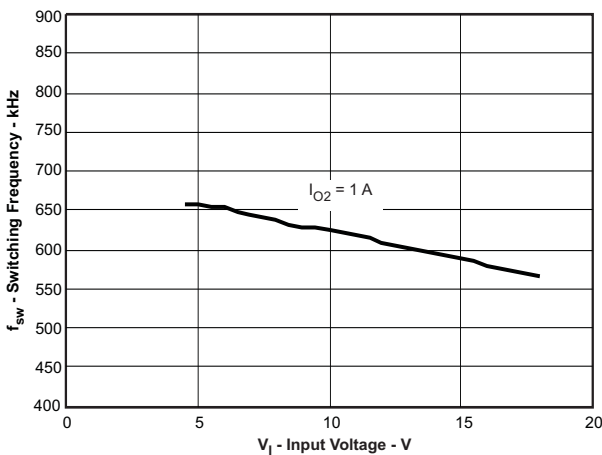

Figure 17.  $V_{O2}=1.5\text{V}$ , SW-frequency vs Input Voltage

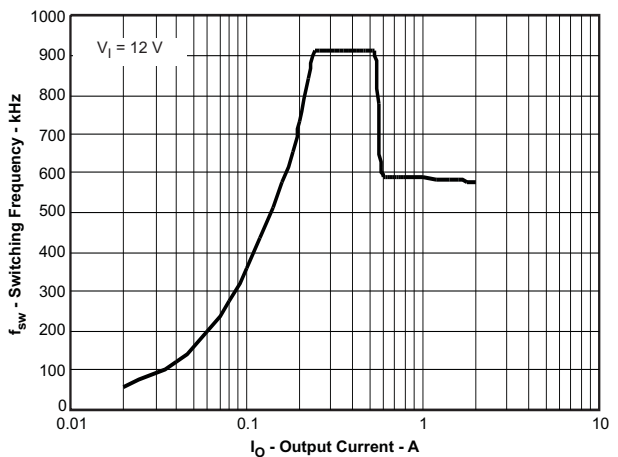

Figure 18.  $V_{O1}=3.3\text{V}$ , SW-frequency vs Output Current

### TYPICAL CHARACTERISTICS

One output is enabled unless otherwise noted. VI = VIN1 or VIN2.  
 VIN = 12 V, TA = 25°C (unless otherwise noted).

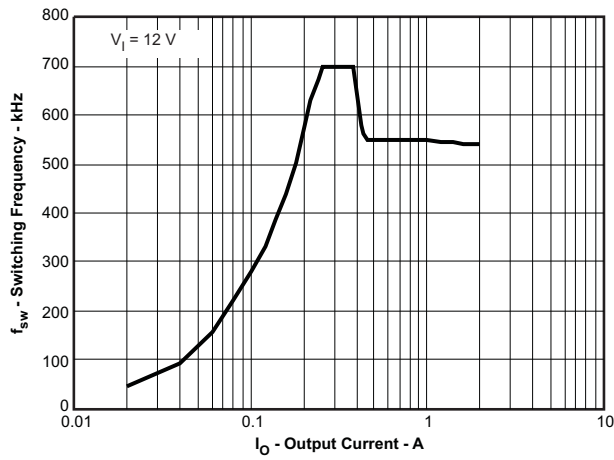

Figure 19. VO2=1.5V, SW-frequency vs Output Current

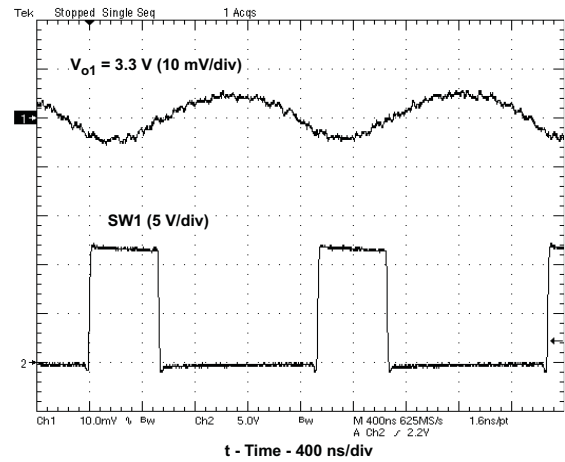

Figure 20. VO1=3.3V, VO1 Ripple Voltage ( $I_{O1}=2\text{A}$ )

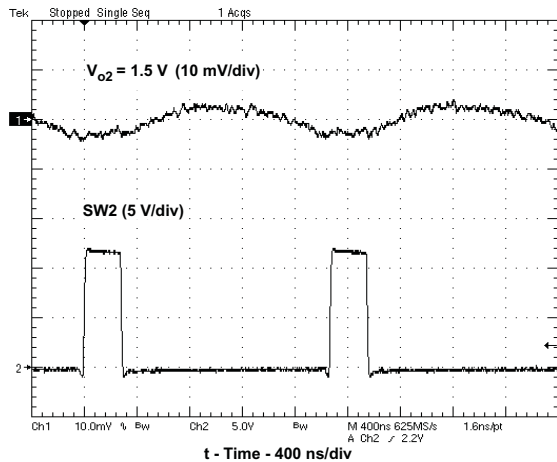

Figure 21. VO2=1.5V, Ripple Voltage ( $I_{O2}=2\text{A}$ )

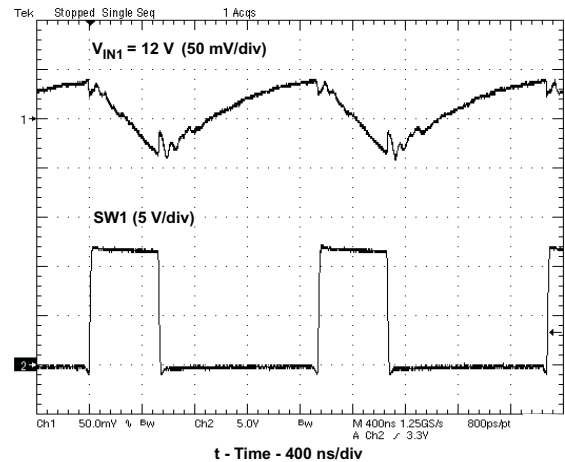

Figure 22. VIN1 Input Voltage Ripple ( $I_{O1}=2\text{A}$ )

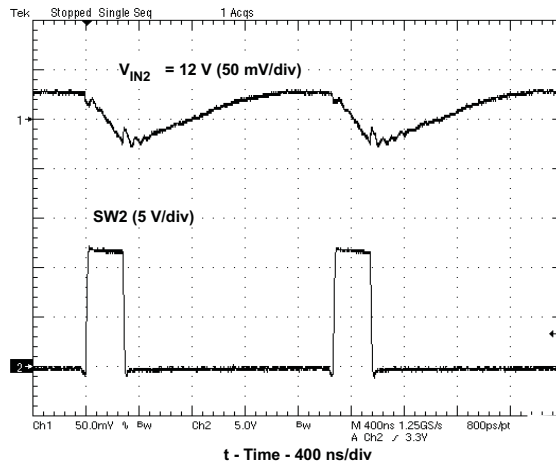

Figure 23. VIN2 INPUT VOLTAGE RIPPLE ( $I_{O2}=2\text{A}$ )

## DESIGN GUIDE

### Step By Step Design Procedure

To begin the design process, you must know a few application parameters:

- Input voltage range
- Output voltage
- Output current

In all formulas x is used to indicate that they are valid for both converters. For the calculations the estimated switching frequency of 700 kHz is used.

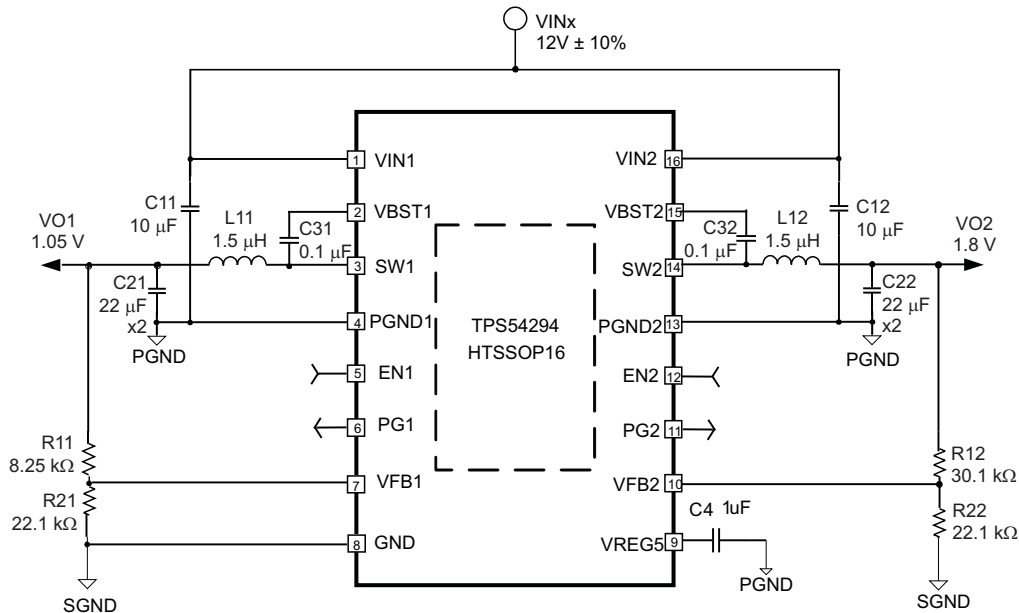

Figure 24. Schematic Diagram for the Design Example

### Output Voltage Resistors Selection

The output voltage is set with a resistor divider from the output node to the VFBx pin. It is recommended to use 1% tolerance or better divider resistors. Start by using Equation 2 to calculate  $V_{Ox}$ .

To improve the efficiency at very light loads consider using larger value resistors, but too high resistance values will be more susceptible to noise and voltage errors due to the VFBx input current will be more noticeable.

$$V_{Ox} = 0.765 \text{ V} \times \left( 1 + \frac{R1x}{R2x} \right) \quad (2)$$

### Output Filter Selection

The output filter used with the TPS54294 is an LC circuit. This LC filter has double pole at:

$$F_p = \frac{1}{2\pi \sqrt{L_{OUT} \times C_{OUT}}} \quad (3)$$

At low frequencies, the overall loop gain is set by the output set-point resistor divider network and the internal gain of the TPS54294. The low frequency phase is 180 degrees. At the output filter pole frequency, the gain rolls off at a –40 dB per decade rate and the phase drops rapidly. D-CAP2™ introduces a high frequency zero that reduces the gain roll off to –20 dB per decade and increases the phase to 90 degrees one decade above the zero frequency. The inductor and capacitor selected for the output filter must be selected so that the double pole of Equation 3 is located below the high frequency zero but close enough that the phase boost provided by the high frequency zero provides adequate phase margin for a stable circuit. To meet this requirement use the values recommended in Table 1.

**Table 1. Recommended Component Values**

OUTPUT VOLTAGE (V)	R1x (kΩ)	R2x (kΩ)	Cffx (pF)	L1x (μH)	C2x (μF)
1	6.81	22.1		1.0-1.5	22 - 68
1.05	8.25	22.1		1.0-1.5	22 - 68
1.2	12.7	22.1		1.0-1.5	22 - 68
1.5	21.5	22.1		1.5	22 - 68
1.8	30.1	22.1	5 - 22	1.5	22 - 68
2.5	49.9	22.1	5 - 22	2.2	22 - 68
3.3	73.2	22.1	5 - 22	2.2	22 - 68
5	124	22.1	5 - 22	3.3	22 - 68

For higher output voltages at or above 1.8 V, additional phase boost can be achieved by adding a feed forward capacitor (Cff) in parallel with R1.

The inductor peak-to-peak ripple current, peak current and RMS current are calculated using Equation 4, Equation 5 and Equation 6. The inductor saturation current rating must be greater than the calculated peak current and the RMS or heating current rating must be greater than the calculated RMS current.

For the calculations, use 700 kHz as the switching frequency,  $f_{SW}$ . Make sure the chosen inductor is rated for the peak current of Equation 5 and the RMS current of Equation 6.

$$\Delta I_{L1x} = \frac{V_{Ox}}{V_{INx(MAX)}} \times \frac{V_{INx(MAX)} - V_{Ox}}{L1x \times f_{SW}} \quad (4)$$

$$I_{Lpeakx} = I_{Ox} + \frac{\Delta I_L}{2} \quad (5)$$

$$I_{LOx(RMS)} = \sqrt{I_{Ox}^2 + \frac{1}{12} \Delta I_L^2} \quad (6)$$

For the above design example, the calculated peak current is 2.46 A and the calculated RMS current is 2.02 A for VO1. The inductor used is a TDK CLF7045-1R5N with a rated current of 7.3A based on the inductance change and of 4.9A based on the temperature rise.

The capacitor value and ESR determines the amount of output voltage ripple. The TPS54294 is intended for use with ceramic or other low ESR capacitors. The recommended value range is from 22μF to 68μF. Use Equation 7 to determine the required RMS current rating for the output capacitor(s).

$$I_{COx(RMS)} = \frac{V_{Ox} \times (V_{INx} - V_{Ox})}{\sqrt{12} \times V_{INx} \times L_{Ox} \times f_{SW}} \quad (7)$$

For this design two TDK C3216X5R0J226M 22μF output capacitors are used. The typical ESR is 2 mΩ each. The calculated RMS current is 0.19A and each output capacitor is rated for 4A.

## Input Capacitor Selection

The TPS54294 requires an input decoupling capacitor and a bulk capacitor is needed depending on the application. A ceramic capacitor of or above 10μF is recommended for the decoupling capacitor. Additionally, 0.1 μF ceramic capacitors from pin 1 and Pin 16 to ground are recommended to improve the stability and reduce the SWx node overshoots. The capacitors voltage rating needs to be greater than the maximum input voltage.

### Bootstrap Capacitor Selection

A 0.1  $\mu\text{F}$  ceramic capacitors must be connected between the VBSTx and SWx pins for proper operation. It is recommended to use ceramic capacitors with a dielectric of X5R or better.

### VREG5 Capacitor Selection

A 1  $\mu\text{F}$  ceramic capacitor must be connected between the VREG5 and GND pins for proper operation. It is recommended to use a ceramic capacitor with a dielectric of X5R or better.

### Thermal Information

This 16-pin PWP package incorporates an exposed thermal pad. The thermal pad must be soldered directly to the printed circuit board (PCB). After soldering, the PCB is used as a heatsink. In addition, through the use of thermal vias, the thermal pad can be attached directly to the appropriate copper plane shown in the electrical schematic for the device, or alternatively, can be attached to a special heatsink structure designed into the PCB. This design optimizes the heat transfer from the integrated circuit (IC).

For additional information on the exposed thermal pad and how to use the advantage of its heat dissipating abilities, refer to the Technical Brief, *PowerPAD™ Thermally Enhanced Package*, Texas Instruments Literature No. [SLMA002](#) and Application Brief, *PowerPAD™ Made Easy*, Texas Instruments Literature No. [SLMA004](#).

The exposed thermal pad dimensions for this package are shown in the following illustration.

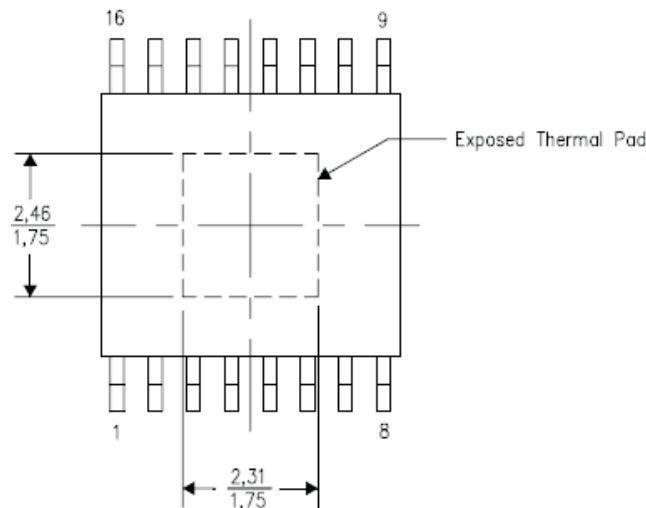
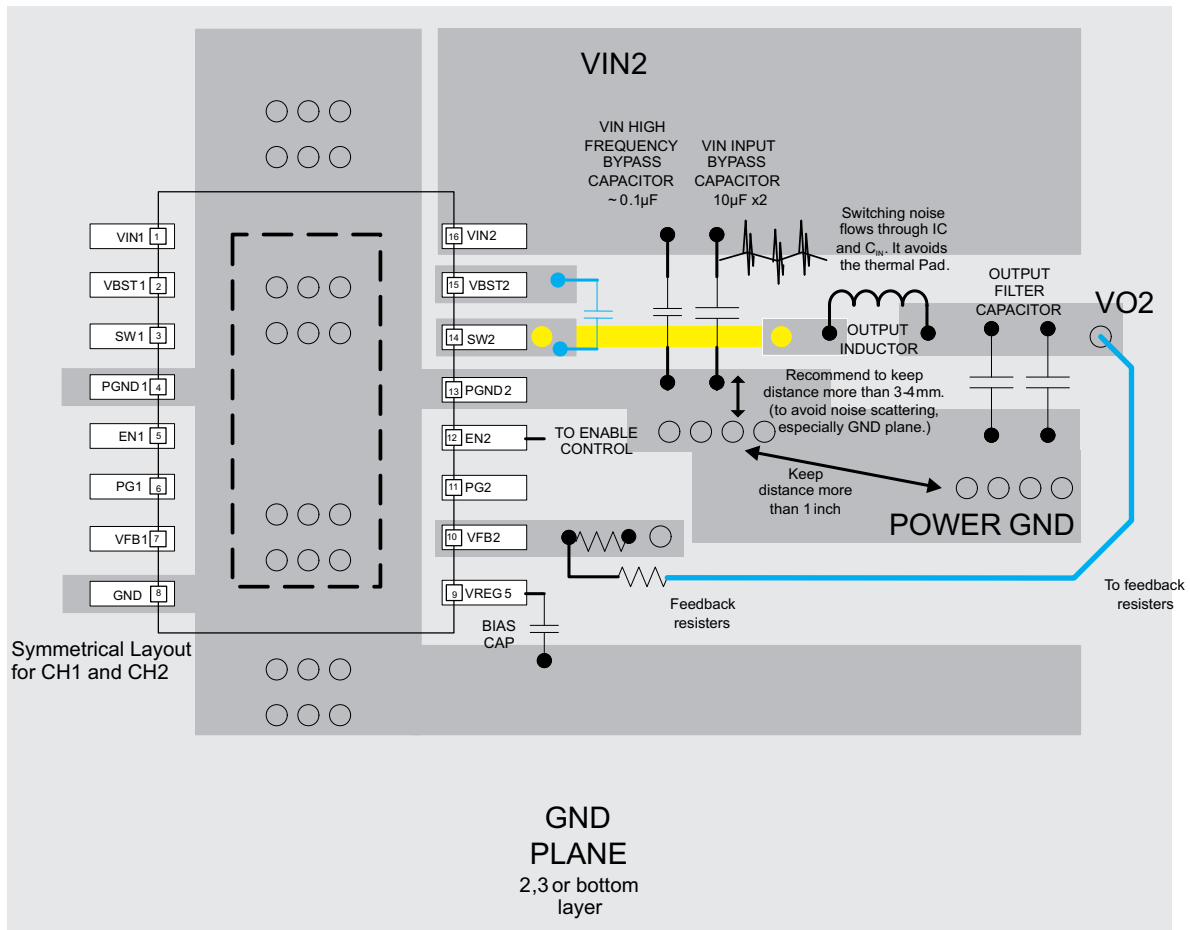

**Figure 25. Thermal Pad Dimensions**

## Layout Considerations

1. Keep the input current loop as small as possible. And avoid the input switching current through the thermal pad.
2. Keep the SW node as physically small and short as possible to minimize parasitic capacitance and inductance and to minimize radiated emissions.
3. Keep analog and non-switching components away from switching components.
4. Make a single point connection from the signal ground to power ground.
5. Do not allow switching currents to flow under the device.
6. Keep the pattern lines for VINx and PGNDx broad.
7. Exposed pad of device must be soldered to PGND.
8. VREG5 capacitor should be placed near the device, and connected to GND.
9. Output capacitors should be connected with a broad pattern to the PGND.
10. Voltage feedback loops should be as short as possible, and preferably with ground shields.
11. Kelvin connections should be brought from the output to the feedback pin of the device.
12. Providing sufficient vias is preferable for VIN, SW and PGND connections.
13. PCB pattern for VIN, SW, and PGND should be as broad as possible.
14. VIN Capacitor should be placed as near as possible to the device.





- Via to GND Plane
- Blue parts can be placed on the bottom side
- Connect the SWx pins through another layer with the inductor (yellow line)

Figure 26. TPS54294 Layout

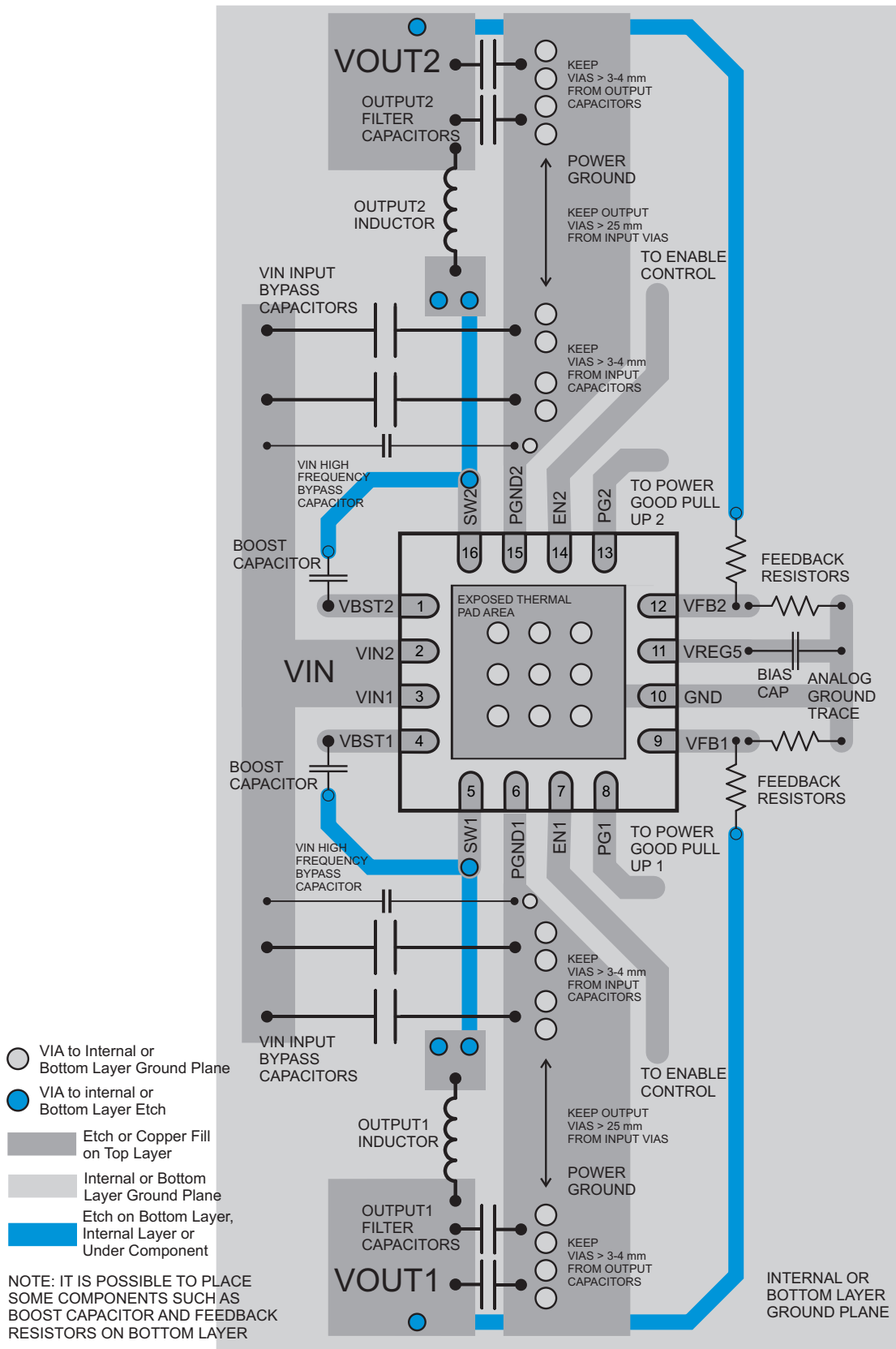

Figure 27. TPS54294 RSA Package Layout

## REVISION HISTORY

NOTE: Page numbers of current version may differ from previous versions.

<b>Changes from Original (October 2011) to Revision A</b>	<b>Page</b>
• Added input voltage range for VFB1, VFB2 to Absolute Maximum Ratings .....	2
• Added input voltage range for VFB1, VFB2 to Recommended Operating Conditions .....	3
• Added indication for not production tested parameters. ....	3
• Added indication for not production tested parameters. ....	4
• Added Over/Under Voltage Protection Description .....	8

<b>Changes from Revision A (November 2011) to Revision B</b>	<b>Page</b>
• Deleted $V_{REG5}$ MIN and MAX values .....	3
• Deleted Line and Load regulation specs from VREG5 specification .....	3
• Added "Specified by design. Not production tested" annotation to MOSFETs specification .....	3
• Deleted MIN and MAX values from $V_{UVREG5}$ specification .....	4

<b>Changes from Revision B (December 2011) to Revision C</b>	<b>Page</b>
• Removed ( SWIFT™) from the data sheet title .....	1
• Added 16-pin VQFN package to Features and Description .....	1
• Added RSA pinout image, pin names and functions to Device Info Section .....	5
• Changed TPS54295, 2 places to TPS54294 in Over/Under Voltage protection section .....	8
• Added RSA-package board layout, .....	18

<b>Changes from Revision C (April 2013) to Revision D</b>	<b>Page</b>
• Deleted $T_A = 25^\circ\text{C}$ from the ELECTRICAL CHARACTERISTICS Conditions column .....	3
• Changed VIN supply current Max value From: 2000 $\mu\text{A}$ To: 2500 $\mu\text{A}$ .....	3
• Changed VIN shutdown current Max value From: 150 $\mu\text{A}$ To: 200 $\mu\text{A}$ .....	3

## PACKAGING INFORMATION

Orderable Device	Status (1)	Package Type	Package Drawing	Pins	Package Qty	Eco Plan (2)	Lead finish/ Ball material (6)	MSL Peak Temp (3)	Op Temp (°C)	Device Marking (4/5)	Samples
TPS54294PWP	ACTIVE	HTSSOP	PWP	16	90	RoHS & Green	NIPDAU	Level-2-260C-1 YEAR	-40 to 85	PS54294	<a href="#">Samples</a>
TPS54294PWPR	ACTIVE	HTSSOP	PWP	16	2000	RoHS & Green	NIPDAU	Level-2-260C-1 YEAR	-40 to 85	PS54294	<a href="#">Samples</a>
TPS54294RSAR	ACTIVE	QFN	RSA	16	3000	RoHS & Green	NIPDAU	Level-1-260C-UNLIM	-40 to 85	TPS 54294	<a href="#">Samples</a>
TPS54294RSAT	ACTIVE	QFN	RSA	16	250	RoHS & Green	NIPDAU	Level-1-260C-UNLIM	-40 to 85	TPS 54294	<a href="#">Samples</a>

(1) The marketing status values are defined as follows:

**ACTIVE:** Product device recommended for new designs.

**LIFEBUY:** TI has announced that the device will be discontinued, and a lifetime-buy period is in effect.

**NRND:** Not recommended for new designs. Device is in production to support existing customers, but TI does not recommend using this part in a new design.

**PREVIEW:** Device has been announced but is not in production. Samples may or may not be available.

**OBSOLETE:** TI has discontinued the production of the device.

(2) **RoHS:** TI defines "RoHS" to mean semiconductor products that are compliant with the current EU RoHS requirements for all 10 RoHS substances, including the requirement that RoHS substance do not exceed 0.1% by weight in homogeneous materials. Where designed to be soldered at high temperatures, "RoHS" products are suitable for use in specified lead-free processes. TI may reference these types of products as "Pb-Free".

**RoHS Exempt:** TI defines "RoHS Exempt" to mean products that contain lead but are compliant with EU RoHS pursuant to a specific EU RoHS exemption.

**Green:** TI defines "Green" to mean the content of Chlorine (Cl) and Bromine (Br) based flame retardants meet JS709B low halogen requirements of <=1000ppm threshold. Antimony trioxide based flame retardants must also meet the <=1000ppm threshold requirement.

(3) MSL, Peak Temp. - The Moisture Sensitivity Level rating according to the JEDEC industry standard classifications, and peak solder temperature.

(4) There may be additional marking, which relates to the logo, the lot trace code information, or the environmental category on the device.

(5) Multiple Device Markings will be inside parentheses. Only one Device Marking contained in parentheses and separated by a "~" will appear on a device. If a line is indented then it is a continuation of the previous line and the two combined represent the entire Device Marking for that device.

(6) Lead finish/Ball material - Orderable Devices may have multiple material finish options. Finish options are separated by a vertical ruled line. Lead finish/Ball material values may wrap to two lines if the finish value exceeds the maximum column width.

**Important Information and Disclaimer:** The information provided on this page represents TI's knowledge and belief as of the date that it is provided. TI bases its knowledge and belief on information provided by third parties, and makes no representation or warranty as to the accuracy of such information. Efforts are underway to better integrate information from third parties. TI has taken and

continues to take reasonable steps to provide representative and accurate information but may not have conducted destructive testing or chemical analysis on incoming materials and chemicals. TI and TI suppliers consider certain information to be proprietary, and thus CAS numbers and other limited information may not be available for release.

In no event shall TI's liability arising out of such information exceed the total purchase price of the TI part(s) at issue in this document sold by TI to Customer on an annual basis.

**TAPE AND REEL INFORMATION**

**QUADRANT ASSIGNMENTS FOR PIN 1 ORIENTATION IN TAPE**

\*All dimensions are nominal

Device	Package Type	Package Drawing	Pins	SPQ	Reel Diameter (mm)	Reel Width W1 (mm)	A0 (mm)	B0 (mm)	K0 (mm)	P1 (mm)	W (mm)	Pin1 Quadrant
TPS54294PWPR	HTSSOP	PWP	16	2000	330.0	12.4	6.9	5.6	1.6	8.0	12.0	Q1
TPS54294RSAR	QFN	RSA	16	3000	330.0	12.4	4.25	4.25	1.15	8.0	12.0	Q2
TPS54294RSAT	QFN	RSA	16	250	180.0	12.4	4.25	4.25	1.15	8.0	12.0	Q2

**TAPE AND REEL BOX DIMENSIONS**

\*All dimensions are nominal

Device	Package Type	Package Drawing	Pins	SPQ	Length (mm)	Width (mm)	Height (mm)
TPS54294PWPR	HTSSOP	PWP	16	2000	356.0	356.0	35.0
TPS54294RSAR	QFN	RSA	16	3000	346.0	346.0	33.0
TPS54294RSAT	QFN	RSA	16	250	182.0	182.0	20.0

**TUBE**

\*All dimensions are nominal

Device	Package Name	Package Type	Pins	SPQ	L (mm)	W (mm)	T (μm)	B (mm)
TPS54294PWP	PWP	HTSSOP	16	90	530	10.2	3600	3.5
TPS54294PWP	PWP	HTSSOP	16	90	530	10.2	3600	3.5



## GENERIC PACKAGE VIEW

**RSA 16**

**VQFN - 1 mm max height**

4 x 4, 0.65 mm pitch

PLASTIC QUAD FLATPACK - NO LEAD

This image is a representation of the package family, actual package may vary.  
Refer to the product data sheet for package details.

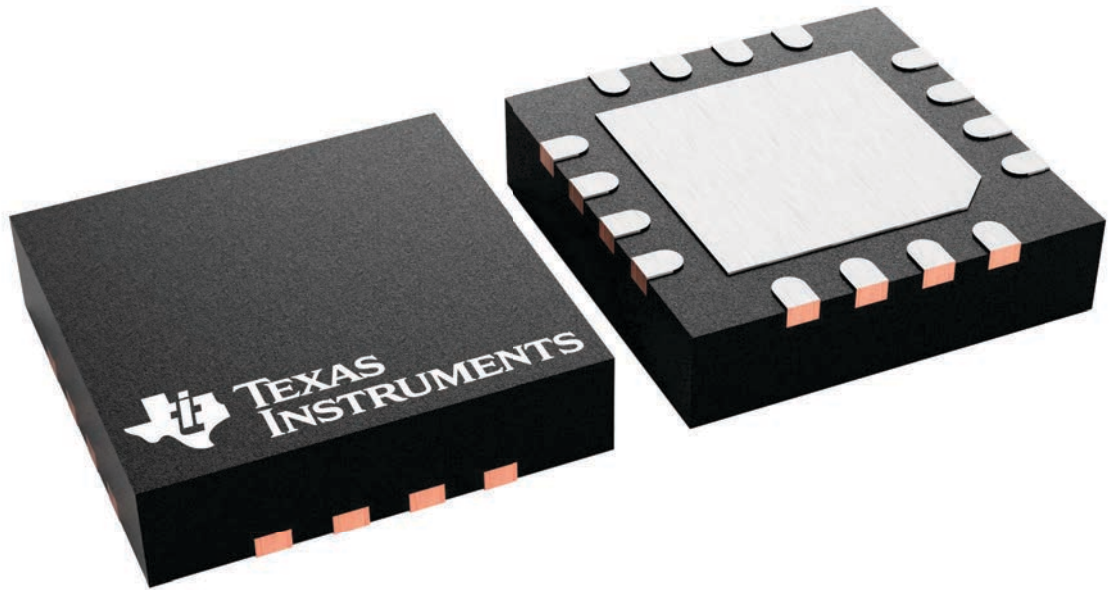

4230969/A

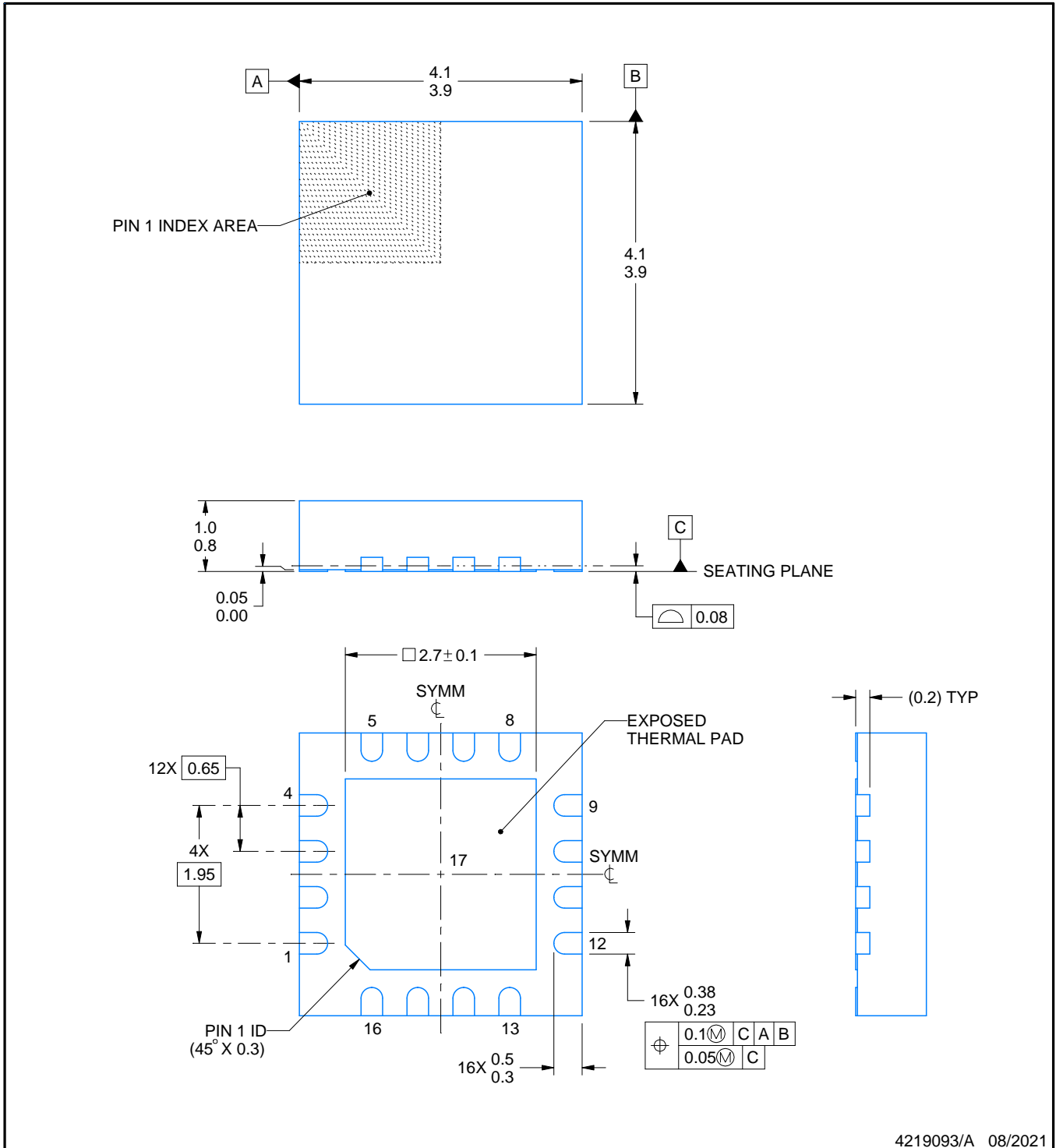
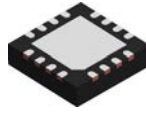

4219093/A 08/2021

NOTES:

1. All linear dimensions are in millimeters. Any dimensions in parenthesis are for reference only. Dimensioning and tolerancing per ASME Y14.5M.
2. This drawing is subject to change without notice.
3. The package thermal pad must be soldered to the printed circuit board for thermal and mechanical performance.
4. Reference JEDEC registration MO-220.

# EXAMPLE BOARD LAYOUT

RSA0016B

VQFN - 1 mm max height

PLASTIC QUAD FLATPACK - NO LEAD

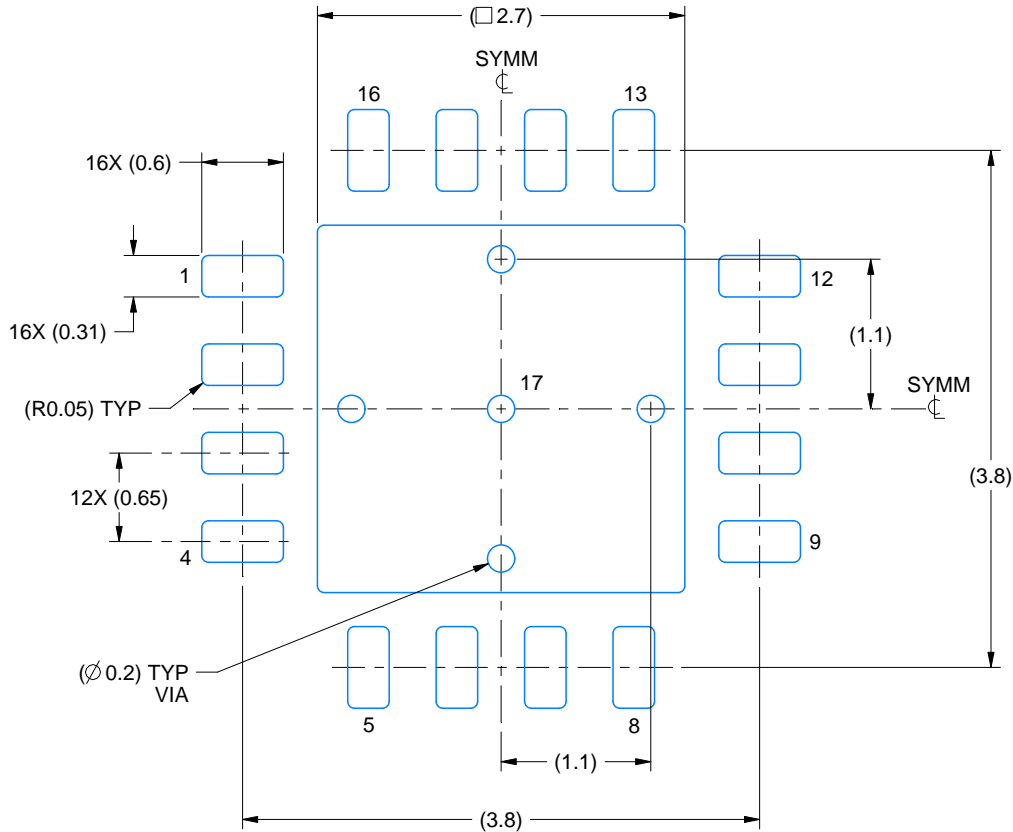

LAND PATTERN EXAMPLE  
EXPOSED METAL SHOWN  
SCALE:18X

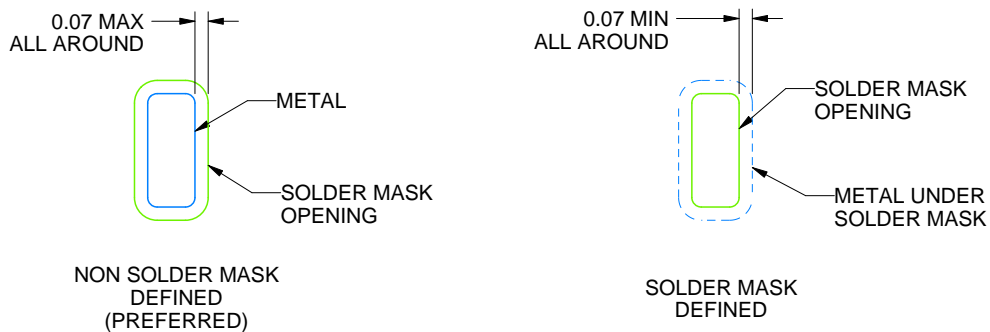

SOLDER MASK DETAILS

4219093/A 08/2021

NOTES: (continued)

5. This package is designed to be soldered to a thermal pad on the board. For more information, see Texas Instruments literature number SLUA271 ([www.ti.com/lit/sluea271](http://www.ti.com/lit/sluea271)).
6. Vias are optional depending on application, refer to device data sheet. If any vias are implemented, refer to their locations shown on this view. It is recommended that vias under paste be filled, plugged or tented.



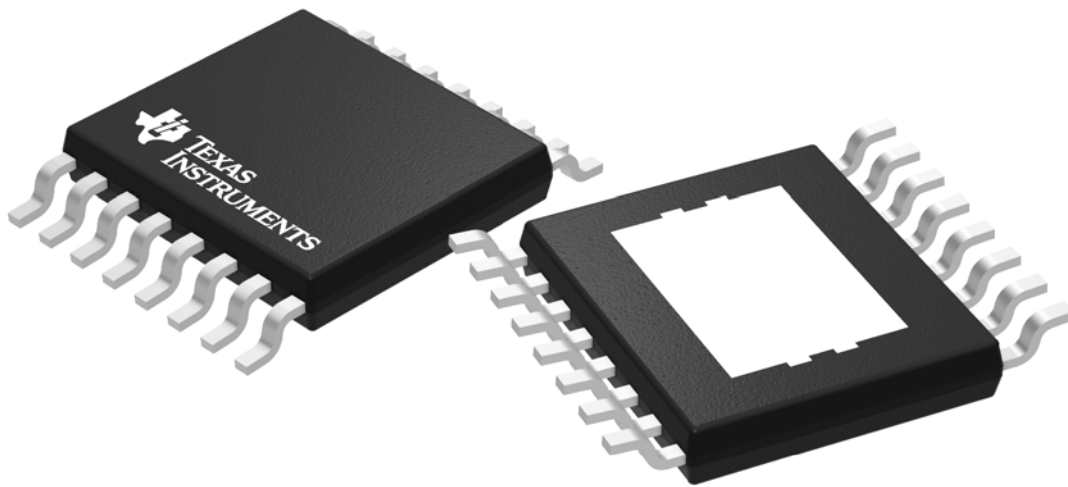

Images above are just a representation of the package family, actual package may vary.  
Refer to the product data sheet for package details.

## IMPORTANT NOTICE AND DISCLAIMER

TI PROVIDES TECHNICAL AND RELIABILITY DATA (INCLUDING DATA SHEETS), DESIGN RESOURCES (INCLUDING REFERENCE DESIGNS), APPLICATION OR OTHER DESIGN ADVICE, WEB TOOLS, SAFETY INFORMATION, AND OTHER RESOURCES "AS IS" AND WITH ALL FAULTS, AND DISCLAIMS ALL WARRANTIES, EXPRESS AND IMPLIED, INCLUDING WITHOUT LIMITATION ANY IMPLIED WARRANTIES OF MERCHANTABILITY, FITNESS FOR A PARTICULAR PURPOSE OR NON-INFRINGEMENT OF THIRD PARTY INTELLECTUAL PROPERTY RIGHTS.

These resources are intended for skilled developers designing with TI products. You are solely responsible for (1) selecting the appropriate TI products for your application, (2) designing, validating and testing your application, and (3) ensuring your application meets applicable standards, and any other safety, security, regulatory or other requirements.

These resources are subject to change without notice. TI grants you permission to use these resources only for development of an application that uses the TI products described in the resource. Other reproduction and display of these resources is prohibited. No license is granted to any other TI intellectual property right or to any third party intellectual property right. TI disclaims responsibility for, and you will fully indemnify TI and its representatives against, any claims, damages, costs, losses, and liabilities arising out of your use of these resources.

TI's products are provided subject to [TI's Terms of Sale](#) or other applicable terms available either on [ti.com](https://www.ti.com) or provided in conjunction with such TI products. TI's provision of these resources does not expand or otherwise alter TI's applicable warranties or warranty disclaimers for TI products.

TI objects to and rejects any additional or different terms you may have proposed.

Mailing Address: Texas Instruments, Post Office Box 655303, Dallas, Texas 75265  
Copyright © 2024, Texas Instruments Incorporated