

Automotive Grade Non-Synchronous Boost Controller

NCV887200

The NCV887200 is an adjustable output non-synchronous boost controller which drives an external N-channel MOSFET. The device uses peak current mode control with internal slope compensation. The IC incorporates an internal regulator that supplies charge to the gate driver.

Protection features include internally-set soft-start, undervoltage lockout, cycle-by-cycle current limiting, hiccup-mode short-circuit protection and thermal shutdown.

Additional features include low quiescent current sleep mode and externally-synchronizable switching frequency.

Features

- Peak Current Mode Control with Internal Slope Compensation
- 1.2 V $\pm 2\%$ Reference voltage
- Fixed Frequency Operation
- Wide Input Voltage Range of 4.8 V to 40 Vdc, 45 V Load Dump
- Input Undervoltage Lockout (UVLO)
- Extended UVLO Hysteresis Allows Continuous Operation with a Reverse Polarity Protection Diode
- Internal Soft-Start
- Low Quiescent Current in Sleep Mode
- Cycle-by-Cycle Current Limit Protection
- Hiccup-Mode Overcurrent Protection (OCP)
- Hiccup-Mode Short-Circuit Protection (SCP)
- Thermal Shutdown (TSD)
- This is a Pb-Free Device
- NCV Prefix for Automotive and Other Applications Requiring Unique Site and Control Change Requirements; AEC-Q100 Qualified and PPAP Capable



ON Semiconductor®

www.onsemi.com

MARKING DIAGRAM



SOIC-8
D SUFFIX
CASE 751

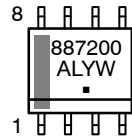

887200 = Specific Device Code
A = Assembly Location
L = Wafer Lot
Y = Year
W = Work Week
▪ = Pb-Free Package

PIN CONNECTIONS

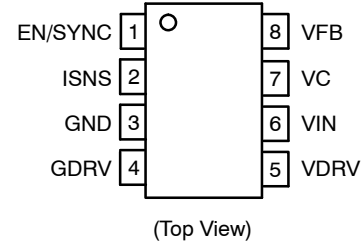

ORDERING INFORMATION

Device	Package	Shipping†
NCV887200D1R2G	SOIC-8 (Pb-Free)	2500 / Tape & Reel

†For information on tape and reel specifications, including part orientation and tape sizes, please refer to our Tape and Reel Packaging Specification Brochure, BRD8011/D.

NCV887200

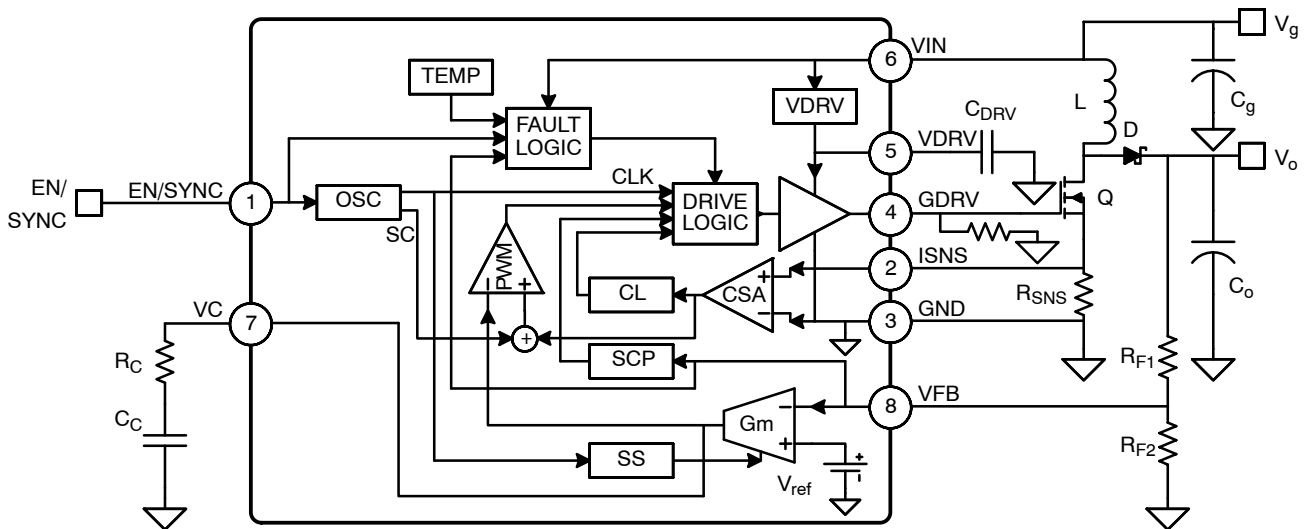

Figure 1. Simplified Block Diagram and Application Schematic

PACKAGE PIN DESCRIPTIONS

Pin No.	Pin Symbol	Function
1	EN/SYNC	Enable and synchronization input. The falling edge synchronizes the internal oscillator. The part is disabled into sleep mode when this pin is brought low for longer than the enable time-out period.
2	ISNS	Current sense input. Connect this pin to the source of the external N-MOSFET, through a current-sense resistor to ground to sense the switching current for regulation and current limiting.
3	GND	Ground reference.
4	GDRV	Gate driver output. Connect to gate of the external N-MOSFET. A series resistance can be added from GDRV to the gate to tailor EMC performance. An $R_{GND} = 15\text{ k}\Omega$ (typical) GDRV-GND resistor is strongly recommended.
5	VDRV	Driving voltage. Internally-regulated supply for driving the external N-MOSFET, sourced from VIN. Bypass with a $1.0\text{ }\mu\text{F}$ ceramic capacitor to ground.
6	VIN	Input voltage. If bootstrapping operation is desired, connect a diode from the input supply to VIN, in addition to a diode from the output voltage to VDRV and/or VIN.
7	VC	Output of the voltage error amplifier. An external compensator network from VC to GND is used to stabilize the converter.
8	VFB	Output voltage feedback. A resistor from the output voltage to VFB with another resistor from VFB to GND creates a voltage divider for regulation and programming of the output voltage.

NCV887200

ABSOLUTE MAXIMUM RATINGS (Voltages are with respect to GND, unless otherwise indicated)

Rating	Value	Unit
Dc Supply Voltage (VIN)	-0.3 to 40	V
Peak Transient Voltage (Load Dump on VIN)	45	V
Dc Supply Voltage (VDRV, GDRV)	12	V
Peak Transient Voltage (VFB)	-0.3 to 6	V
Dc Voltage (VC, VFB, ISNS)	-0.3 to 3.6	V
Dc Voltage (EN/SYNC)	-0.3 to 6	V
Dc Voltage Stress (VIN - VDRV)*	-0.7 to 45	V
Operating Junction Temperature	-40 to 150	°C
Storage Temperature Range	-65 to 150	°C
Peak Reflow Soldering Temperature: Pb-Free, 60 to 150 seconds at 217°C	265 peak	°C

Stresses exceeding those listed in the Maximum Ratings table may damage the device. If any of these limits are exceeded, device functionality should not be assumed, damage may occur and reliability may be affected.

*An external diode from the input to the VIN pin is required if bootstrapping VDRV and VIN off of the output voltage.

PACKAGE CAPABILITIES

Characteristic	Value	Unit	
ESD Capability (All Pins)	Human Body Model Machine Model	≥ 2.0 ≥ 200	kV V
Moisture Sensitivity Level	1	-	
Package Thermal Resistance	Junction-to-Ambient, R _{θJA} (Note 1)	100	°C/W

1. 1 in², 1 oz copper area used for heatsinking.

Device Variations

The NCV8872 features several variants to better fit a multitude of applications. The table below shows the typical

values of parameters for the parts that are currently available.

TYPICAL VALUES

Part No.	D _{max}	f _s	t _{ss}	S _a	V _{cl}	I _{src}	I _{sink}	V _{DRV}	SCE
NCV887200	92%	675 kHz	1.9 ms	34 mV/μs	200 mV	575 mA	375 mA	8.4 V	Y

DEFINITIONS

Symbol	Characteristic	Symbol	Characteristic	Symbol	Characteristic
D _{max}	Maximum Duty Cycle	f _s	Switching Frequency	t _{ss}	Soft-Start Time
S _a	Slope Compensating Ramp	V _{cl}	Current Limit Trip Voltage	I _{src}	Gate Drive Sourcing Current
I _{sink}	Gate Drive Sinking Current	V _{DRV}	Drive Voltage	SCE	Short Circuit Enable

NCV887200

ELECTRICAL CHARACTERISTICS ($-40^{\circ}\text{C} < T_J < 150^{\circ}\text{C}$, $4.8\text{ V} < V_{IN} < 40\text{ V}$, unless otherwise specified) Min/Max values are guaranteed by test, design or statistical correlation.

Characteristic	Symbol	Conditions	Min	Typ	Max	Unit
----------------	--------	------------	-----	-----	-----	------

GENERAL

Quiescent Current, Sleep Mode	$I_{q,sleep}$	$V_{IN} = 13.2\text{ V}$, $EN = 0$, $T_J = 25^{\circ}\text{C}$	–	2.0	–	μA
Quiescent Current, Sleep Mode	$I_{q,sleep}$	$V_{IN} = 13.2\text{ V}$, $EN = 0$, $-40^{\circ}\text{C} < T_J < 125^{\circ}\text{C}$	–	2.0	6.0	μA
Quiescent Current, No switching	$I_{q,off}$	Into V_{IN} pin, $EN = 1$, No switching	–	1.5	2.5	mA
Quiescent Current, Switching, Normal Operation	$I_{q,on}$	Into V_{IN} pin, $EN = 1$, Switching	–	3.0	6.0	mA

OSCILLATOR

Minimum Pulse Width	$t_{on,min}$		90	115	140	ns
Maximum Duty Cycle	D_{max}		91	92	93.5	%
Switching Frequency	f_s		608	675	742	kHz
Soft-Start Time	t_{ss}	From start of switching with $V_{FB} = 0$ until reference voltage = V_{REF}	1.55	1.90	2.25	ms
Soft-Start Delay	$t_{ss,dly}$	From $EN \rightarrow 1$ until start of switching with $V_{FB} = 0$ with V_C pin compensation network disconnected	–	200	280	μs
Slope Compensating Ramp	S_a		30	34	38	$\text{mV}/\mu\text{s}$

ENABLE/SYNCHRONIZATION

EN/SYNC Pull-Down Current	$I_{EN/SYNC}$	$V_{EN/SYNC} = 5\text{ V}$	–	5.0	10	μA
EN/SYNC Input High Voltage	$V_{s,ih}$		2.0	–	5.0	V
EN/SYNC Input Low Voltage	$V_{s,il}$		0	–	800	mV
EN/SYNC Time-Out Ratio	$\%t_{en}$	From SYNC falling edge, to oscillator control (EN high) or shutdown (EN low), Percent of typical switching period	–	–	350	%
SYNC Minimum Frequency Ratio	$\%f_{sync,min}$	Percent of f_s	–	–	80	%
SYNC Maximum Frequency	$f_{sync,max}$		1.1	–	–	MHz
Synchronization Delay	$t_{s,dly}$	From SYNC falling edge to GDRV falling edge under open loop conditions	–	50	100	ns
Synchronization Duty Cycle	D_{sync}		25	–	75	%

CURRENT SENSE AMPLIFIER

Low-Frequency Gain	A_{csa}	Input-to-output gain at dc, $ISNS \leq 1\text{ V}$	0.9	1.0	1.1	V/V
Bandwidth	BW_{csa}	Gain of $A_{csa} - 3\text{ dB}$	2.5	–	–	MHz
ISNS Input Bias Current	$I_{sns,bias}$	Out of ISNS pin	–	30	50	μA
Current Limit Threshold Voltage	V_{cl}	Voltage on ISNS pin	180	200	220	mV
Current Limit, Response Time	t_{cl}	CL tripped until GDRV falling edge, $V_{ISNS} = V_{cl}(typ) + 60\text{ mV}$	–	80	125	ns
Overcurrent Protection, Threshold Voltage	$\%V_{ocp}$	Percent of V_{cl}	125	150	175	%
Overcurrent Protection, Response Time	t_{ocp}	From overcurrent event, Until switching stops, $V_{ISNS} = V_{OCP} + 40\text{ mV}$	–	–	125	ns

VOLTAGE ERROR OPERATIONAL TRANSCONDUCTANCE AMPLIFIER

Transconductance	$g_{m,vea}$	$V_{FB} - V_{ref} = \pm 20\text{ mV}$	0.8	1.2	1.63	mS
VEA Output Resistance	$R_{o,vea}$		2.0	–	–	$\text{M}\Omega$
VFB Input Bias Current	$I_{vfb,bias}$	Current out of VFB pin	–	0.5	2.0	μA
Reference Voltage	V_{ref}		1.176	1.200	1.224	V
VEA Maximum Output Voltage	$V_{c,max}$		2.5	–	–	V

NCV887200

ELECTRICAL CHARACTERISTICS ($-40^{\circ}\text{C} < T_J < 150^{\circ}\text{C}$, $4.8\text{ V} < V_{IN} < 40\text{ V}$, unless otherwise specified) Min/Max values are guaranteed by test, design or statistical correlation.

Characteristic	Symbol	Conditions	Min	Typ	Max	Unit
----------------	--------	------------	-----	-----	-----	------

VOLTAGE ERROR OPERATIONAL TRANSCONDUCTANCE AMPLIFIER

VEA Minimum Output Voltage	$V_{c,min}$		-	-	0.3	V
VEA Sourcing Current	$I_{src,vea}$	VEA output current, $V_c = 2.0\text{ V}$	80	100	-	μA
VEA Sinking Current	$I_{snk,vea}$	VEA output current, $V_c = 0.7\text{ V}$	80	100	-	μA

GATE DRIVER

Sourcing Current	I_{src}	$V_{DRV} \geq 6\text{ V}$, $V_{DRV} - V_{GDRV} = 2\text{ V}$	400	575	-	mA
Sinking Current	I_{sink}	$V_{GDRV} \geq 2\text{ V}$	250	375	-	mA
Driving Voltage Dropout	$V_{drv,do}$	$V_{IN} - V_{DRV}$, $I_{VDRV} = 25\text{ mA}$	-	0.3	0.6	V
Driving Voltage Source Current	I_{drv}	$V_{IN} - V_{DRV} = 1\text{ V}$	35	45	-	mA
Backdrive Diode Voltage Drop	$V_{d,bd}$	$V_{DRV} - V_{IN}$, $I_{d,bd} = 5\text{ mA}$	-	-	0.7	V
Driving Voltage	V_{DRV}	$I_{VDRV} = 0.1 - 25\text{ mA}$	8.0	8.4	8.8	V

UVLO

Undervoltage Lock-Out, Threshold Voltage	V_{uvlo}	V_{IN} falling V_{IN} rising	4.6 -	4.75 5.23	4.90 5.45	V
Undervoltage Lock-Out, Hysteresis	$V_{uvlo,hys}$	V_{IN} rising	350	500	-	mV

SHORT CIRCUIT PROTECTION

Startup blanking period	$\%t_{scp,dly}$	From start of soft-start, Percent of t_{ss}	100	120	150	%
Hiccup-mode period	$\%t_{hcp,dly}$	From shutdown to start of soft-start, Percent of t_{ss}	70	85	100	%
Short circuit threshold voltage	$\%V_{scp}$	V_{FB} as percent of V_{ref}	60	67	75	%
Short circuit delay	t_{scp}	From $V_{FB} < V_{scp}$ to stop switching	-	35	100	ns

THERMAL SHUTDOWN

Thermal shutdown threshold	T_{sd}	T_J rising	160	170	180	$^{\circ}\text{C}$
Thermal shutdown hysteresis	$T_{sd,hys}$	T_J falling	10	15	20	$^{\circ}\text{C}$
Thermal shutdown delay	$t_{sd,dly}$	From $T_J > T_{sd}$ to stop switching	-	-	100	ns

TYPICAL PERFORMANCE CHARACTERISTICS

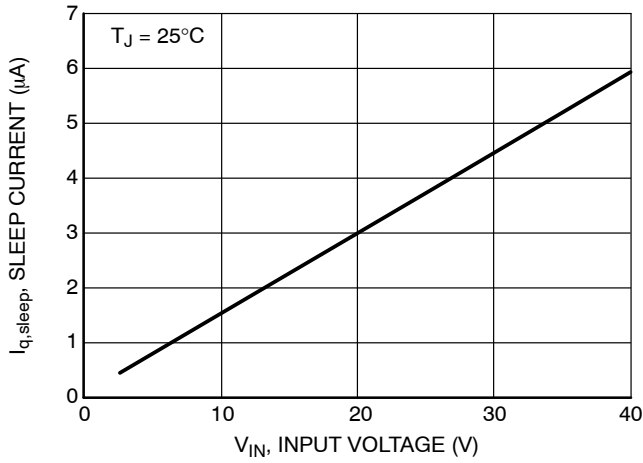

Figure 2. Sleep Current vs. Input Voltage

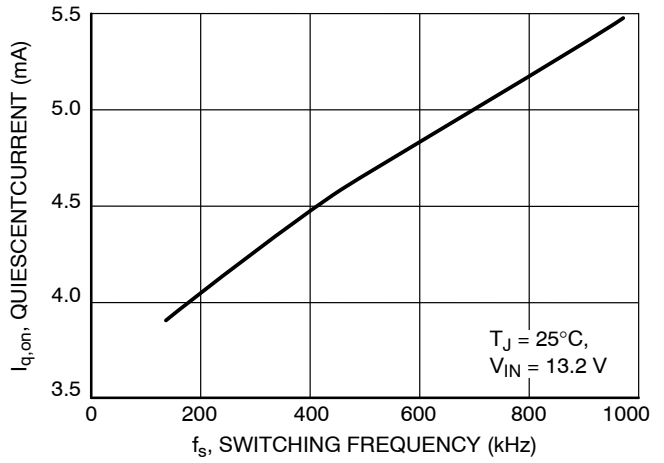

Figure 3. Quiescent Current vs. Switching Frequency

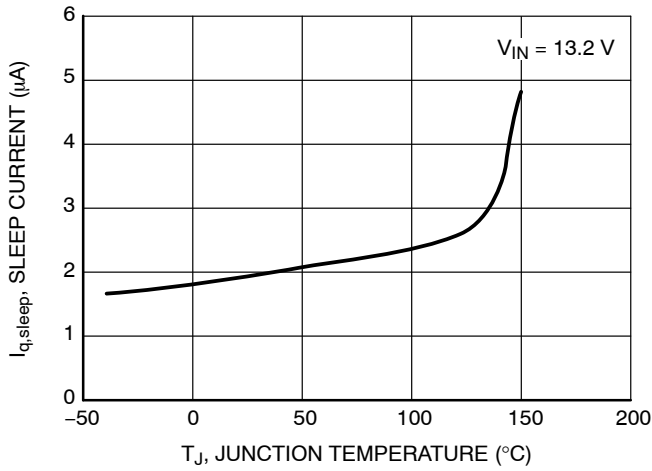

Figure 4. Sleep Current vs. Temperature

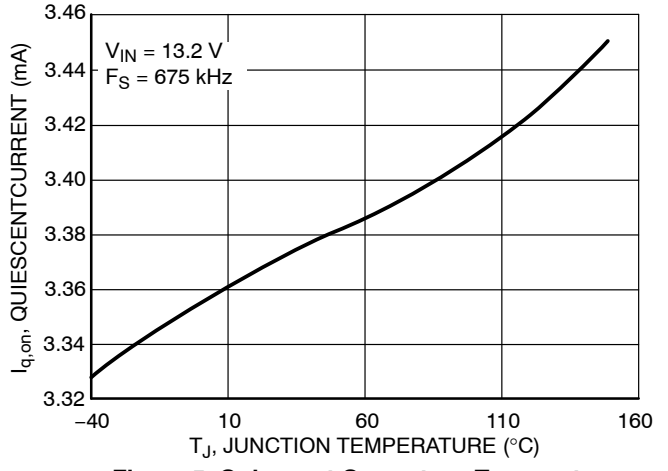

Figure 5. Quiescent Current vs. Temperature

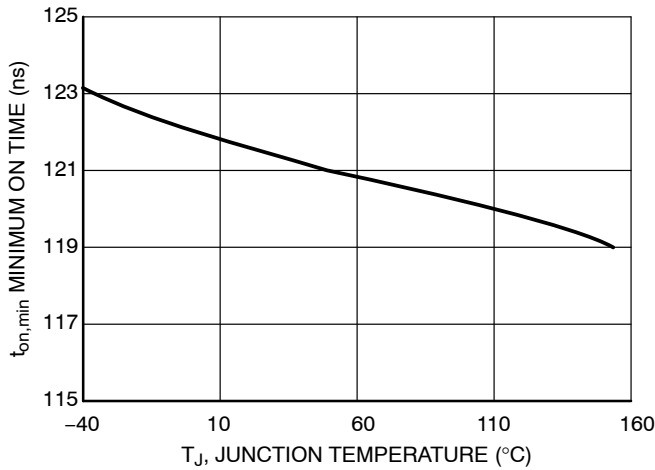

Figure 6. Minimum On Time vs. Temperature

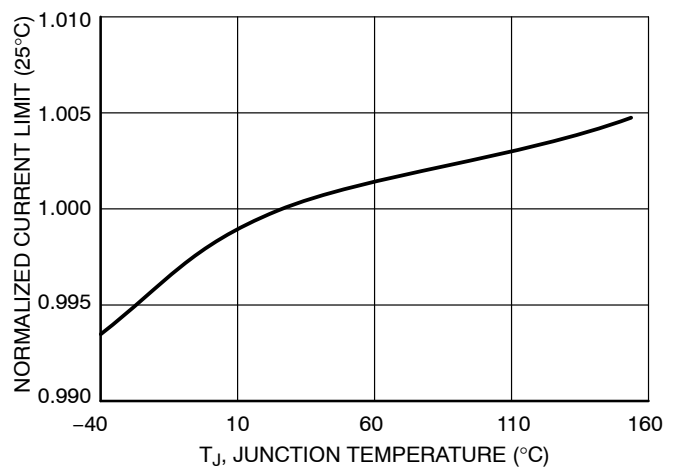

Figure 7. Normalized Current Limit vs. Temperature

TYPICAL PERFORMANCE CHARACTERISTICS

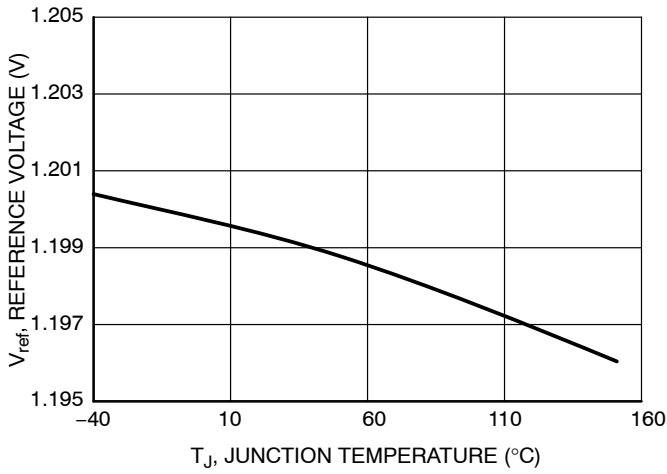

Figure 8. Reference Voltage vs. Temperature

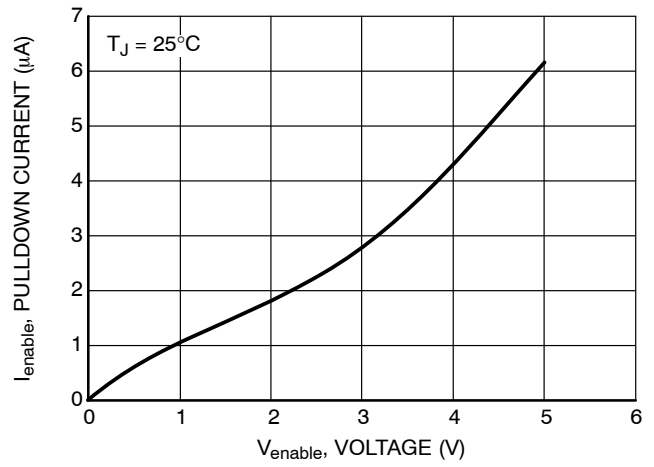

Figure 9. Enable Pulldown Current vs. Voltage

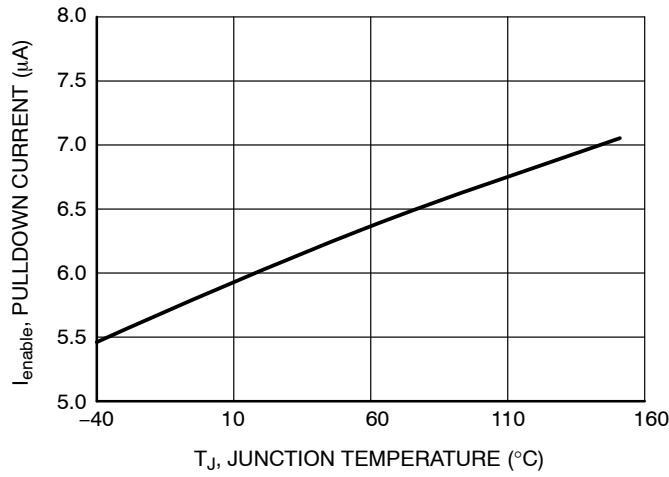

Figure 10. Enable Pulldown Current vs. Temperature

THEORY OF OPERATION

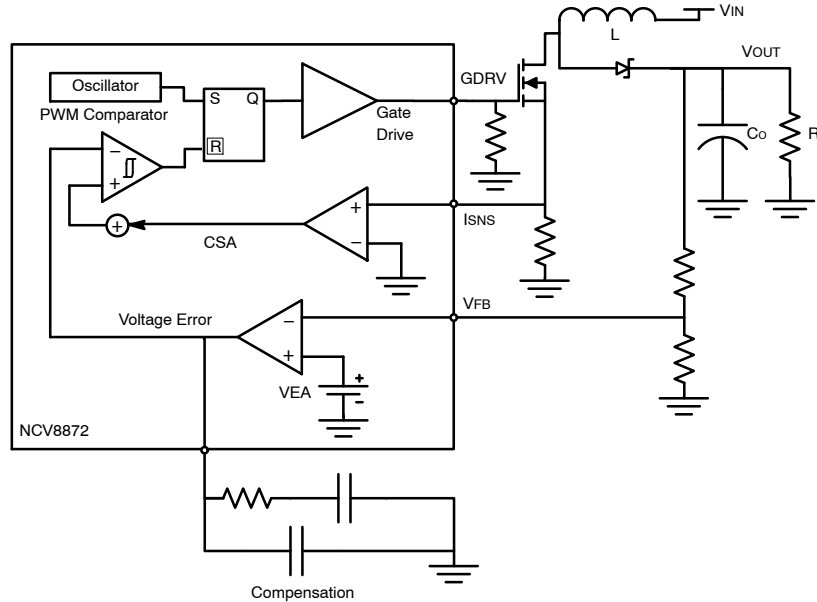

Figure 11. Current Mode Control Schematic

Current Mode Control

The NCV887200 incorporates a current mode control scheme, in which the PWM ramp signal is derived from the power switch current. This ramp signal is compared to the output of the error amplifier to control the on-time of the power switch. The oscillator is used as a fixed-frequency clock to ensure a constant operational frequency. The resulting control scheme features several advantages over conventional voltage mode control. First, derived directly from the inductor, the ramp signal responds immediately to line voltage changes. This eliminates the delay caused by the output filter and the error amplifier, which is commonly found in voltage mode controllers. The second benefit comes from inherent pulse-by-pulse current limiting by merely clamping the peak switching current. Finally, since current mode commands an output current rather than voltage, the filter offers only a single pole to the feedback loop. This allows for a simpler compensation.

The NCV8872 also includes a slope compensation scheme in which a fixed ramp generated by the oscillator is added to the current ramp. A proper slope rate is provided to improve circuit stability without sacrificing the advantages of current mode control.

Current Limit

The NCV887200 features two current limit protections, peak current mode and over current latch off. When the current sense amplifier detects a voltage above the peak current limit between ISNS and GND after the current limit leading edge blanking time, the peak current limit causes the power switch to turn off for the remainder of the cycle. Set the current limit with a resistor from ISNS to GND, with $R = V_{CL} / I_{limit}$.

If the voltage across the current sense resistor exceeds the over current threshold voltage the device enters over current hiccup mode. The device will remain off for the hiccup time and then go through the soft-start procedure.

Short Circuit Protection

If the short circuit enable bit is set (SCE = Y) the device will attempt to protect the power MOSFET from damage. When the output voltage falls below the short circuit trip voltage, after the initial short circuit blanking time, the device enters short circuit latch off. The device will remain off for the hiccup time and then go through the soft-start.

EN/SYNC

The Enable/Synchronization pin has three modes. When a dc logic high (CMOS/TTL compatible) voltage is applied to this pin the NCV887200 operates at the programmed frequency. When a dc logic low voltage is applied to this pin the NCV887200 enters a low quiescent current sleep mode. When a square wave of at least $\%f_{sync,min}$ of the free running switching frequency is applied to this pin, the switcher operates at the same frequency as the square wave. If the signal is slower than this, it will be interpreted as enabling and disabling the part. The falling edge of the square wave corresponds to the start of the switching cycle.

UVLO

Input Undervoltage Lockout (UVLO) is provided to ensure that unexpected behavior does not occur when VIN is too low to support the internal rails and power the controller. The IC will start up when enabled and VIN surpasses the UVLO threshold plus the UVLO hysteresis and will shut down when VIN drops below the UVLO threshold or the part is disabled.

Internal Soft-Start

To insure moderate inrush current and reduce output overshoot, the NCV887200 features a soft start which charges a capacitor with a fixed current to ramp up the reference voltage. This fixed current is based on the switching frequency, so that if the NCV887200 is synchronized to twice the default switching frequency the soft start will last half as long.

VDRV

An internal regulator provides the drive voltage for the gate driver. Bypass with a ceramic capacitor to ground to ensure fast turn on times. The capacitor should be between 0.1 μF and 1 μF, depending on switching speed and charge requirements of the external MOSFET.

GDRV

An $R_{GND} = 15\text{ k}\Omega$ (typical) GDRV-GND resistor is strongly recommended.

APPLICATION INFORMATION

Design Methodology

This section details an overview of the component selection process for the NCV8872 in continuous conduction mode boost. It is intended to assist with the design process but does not remove all engineering design work. Many of the equations make heavy use of the small ripple approximation. This process entails the following steps:

1. Define Operational Parameters
2. Select Current Sense Resistor
3. Select Output Inductor
4. Select Output Capacitors
5. Select Input Capacitors
6. Select Feedback Resistors
7. Select Compensator Components
8. Select MOSFET(s)
9. Select Diode
10. Determine Feedback Loop Compensation Network

1. Define Operational Parameters

Before beginning the design, define the operating parameters of the application. These include:

- $V_{IN(min)}$: minimum input voltage [V]
- $V_{IN(max)}$: maximum input voltage [V]
- V_{OUT} : output voltage [V]
- $I_{OUT(max)}$: maximum output current [A]
- I_{CL} : desired typical cycle-by-cycle current limit [A]

From this the ideal minimum and maximum duty cycles can be calculated as follows:

$$D_{min} = 1 - \frac{V_{IN(max)}}{V_{OUT}}$$

$$D_{max} = 1 - \frac{V_{IN(min)}}{V_{OUT}}$$

Both duty cycles will actually be higher due to power loss in the conversion. The exact duty cycles will depend on conduction and switching losses. If the maximum input voltage is higher than the output voltage, the minimum duty cycle will be negative. This is because a boost converter cannot have an output lower than the input. In situations where the input is higher than the output, the output will follow the input, minus the diode drop of the output diode and the converter will not attempt to switch.

If the calculated D_{max} is higher the D_{max} of the NCV887200, the conversion will not be possible. It is important for a boost converter to have a restricted D_{max} , because while the ideal conversion ration of a boost converter goes up to infinity as D approaches 1, a real converter's conversion ratio starts to decrease as losses overtake the increased power transfer. If the converter is in this range it will not be able to regulate properly.

If the following equation is not satisfied, the device will skip pulses at high V_{IN} :

$$\frac{D_{min}}{f_s} \geq t_{on(min)}$$

Where: f_s : switching frequency [Hz]
 $t_{on(min)}$: minimum on time [s]

2. Select Current Sense Resistor

Current sensing for peak current mode control and current limit relies on the MOSFET current signal, which is measured with a ground referenced amplifier. The easiest method of generating this signal is to use a current sense resistor from the source of the MOSFET to device ground. The sense resistor should be selected as follows:

$$R_s = \frac{V_{CL}}{I_{CL}}$$

Where: R_s : sense resistor [Ω]
 V_{CL} : current limit threshold voltage [V]
 I_{CL} : desire current limit [A]

3. Select Output Inductor

The output inductor controls the current ripple that occurs over a switching period. A high current ripple will result in excessive power loss and ripple current requirements. A low current ripple will result in a poor control signal and a slow current slew rate in case of load steps. A good starting point for peak to peak ripple is around 20–40% of the inductor current at the maximum load at the worst case V_{IN} , but operation should be verified empirically. The worst case V_{IN} is half of V_{OUT} , or whatever V_{IN} is closest to half of V_{OUT} . After choosing a peak current ripple value, calculate the inductor value as follows:

$$L = \frac{V_{IN(WC)} D_{WC}}{\Delta I_{L,max} f_s}$$

Where: $V_{IN(WC)}$: V_{IN} value as close as possible to half of V_{OUT} [V]
 D_{WC} : duty cycle at $V_{IN(WC)}$
 $\Delta I_{L,max}$: maximum peak to peak ripple [A]

The maximum average inductor current can be calculated as follows:

$$I_{L,AVG} = \frac{V_{OUT} I_{OUT(max)}}{V_{IN(min)} \eta}$$

The Peak Inductor current can be calculated as follows:

$$I_{L,peak} = I_{L,avg} + \frac{\Delta I_{L,max}}{2}$$

Where: $I_{L,peak}$: Peak inductor current value [A]

4. Select Output Capacitors

The output capacitors smooth the output voltage and reduce the overshoot and undershoot associated with line transients. The steady state output ripple associated with the output capacitors can be calculated as follows:

$$V_{OUT(ripple)} = \frac{D I_{OUT(max)}}{f C_{OUT}} + \left(\frac{I_{OUT(max)}}{1-D} + \frac{V_{IN(min)} D}{2fL} \right) R_{ESR}$$

The capacitors need to survive an RMS ripple current as follows:

$$I_{Cout(RMS)} = I_{OUT} \sqrt{\frac{D_{WC}}{D'_{WC}} + \frac{D_{WC}}{12} \left(\frac{D'_{WC}}{\frac{L}{R_{OUT} \times T_{SW}}} \right)^2}$$

The use of parallel ceramic bypass capacitors is strongly encouraged to help with the transient response.

5. Select Input Capacitors

The input capacitor reduces voltage ripple on the input to the module associated with the ac component of the input current.

$$I_{Cin(RMS)} = \frac{V_{IN(min)}^2 D_{WC}}{L f_s V_{OUT} 2\sqrt{3}}$$

6. Select Feedback Resistors

The feedback resistors form a resistor divider from the output of the converter to ground, with a tap to the feedback pin. During regulation, the divided voltage will equal V_{ref} . The lower feedback resistor can be chosen, and the upper feedback resistor value is calculated as follows:

$$R_{upper} = R_{lower} \frac{(V_{out} - V_{ref})}{V_{ref}}$$

The total feedback resistance ($R_{upper} + R_{lower}$) should be in the range of 1 k Ω – 100 k Ω .

7. Select Compensator Components

Current Mode control method employed by the NCV8872 allows the use of a simple, Type II compensation to optimize the dynamic response according to system requirements.

8. Select MOSFET(s)

In order to ensure the gate drive voltage does not drop out the MOSFET(s) chosen must not violate the following inequality:

$$Q_{g(total)} \leq \frac{I_{drv}}{f_s}$$

Where: $Q_{g(total)}$: Total Gate Charge of MOSFET(s) [C]

I_{drv} : Drive voltage current [A]

f_s : Switching Frequency [Hz]

The maximum RMS Current can be calculated as follows:

$$I_{Q(max)} = I_{out} \sqrt{\frac{D}{D'}}$$

The maximum voltage across the MOSFET will be the maximum output voltage, which is the higher of the maximum input voltage and the regulated output voltage:

$$V_{Q(max)} = V_{OUT(max)}$$

9. Select Diode

The output diode rectifies the output current. The average current through diode will be equal to the output current:

$$I_{D(avg)} = I_{OUT(max)}$$

Additionally, the diode must block voltage equal to the higher of the output voltage and the maximum input voltage:

$$V_{D(max)} = V_{OUT(max)}$$

The maximum power dissipation in the diode can be calculated as follows:

$$P_D = V_{f(max)} I_{OUT(max)}$$

Where: P_D : Power dissipation in the diode [W]

$V_{f(max)}$: Maximum forward voltage of the diode [V]

10. Determine Feedback Loop Compensation Network

The purpose of a compensation network is to stabilize the dynamic response of the converter. By optimizing the compensation network, stable regulation response is achieved for input line and load transients.

Compensator design involves the placement of poles and zeros in the closed loop transfer function. Losses from the boost inductor, MOSFET, current sensing and boost diode losses also influence the gain and compensation expressions. The OTA has an ESD protection structure ($R_{ESD} \approx 502 \Omega$, data not provided in the datasheet) located on the die between the OTA output and the IC package compensation pin (VC). The information from the OTA PWM feedback control signal (V_{CTRL}) may differ from the IC-VC signal if R_2 is of similar order of magnitude as R_{ESD} . The compensation and gain expressions which follow take influence from the OTA output impedance elements into account.

Type-I compensation is not possible due to the presence of R_{ESD} . The Figures 12 and 13 compensation networks correspond to a Type-II network in series with R_{ESD} . The resulting control-output transfer function is an accurate

NCV887200

mathematical model of the IC in a boost converter topology. The model does have limitations and a more accurate SPICE model should be considered for a more detailed analysis:

- The attenuating effect of large value ceramic capacitors in parallel with output electrolytic capacitor ESR is not considered in the equations.
- The CCM Boost control-output transfer function includes operating efficiency as a correction factor to improve modeling accuracy under low input voltage and high output current operating conditions where operating losses becomes significant.

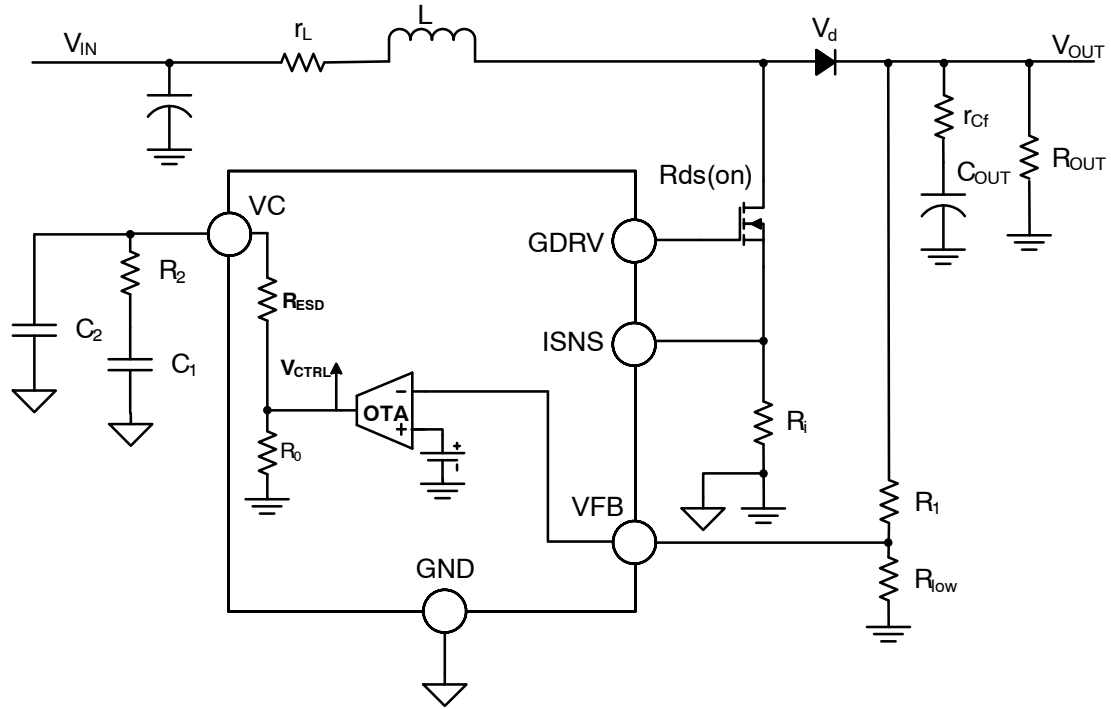

Figure 12. NCV887200 Boost Converter OTA and Compensation

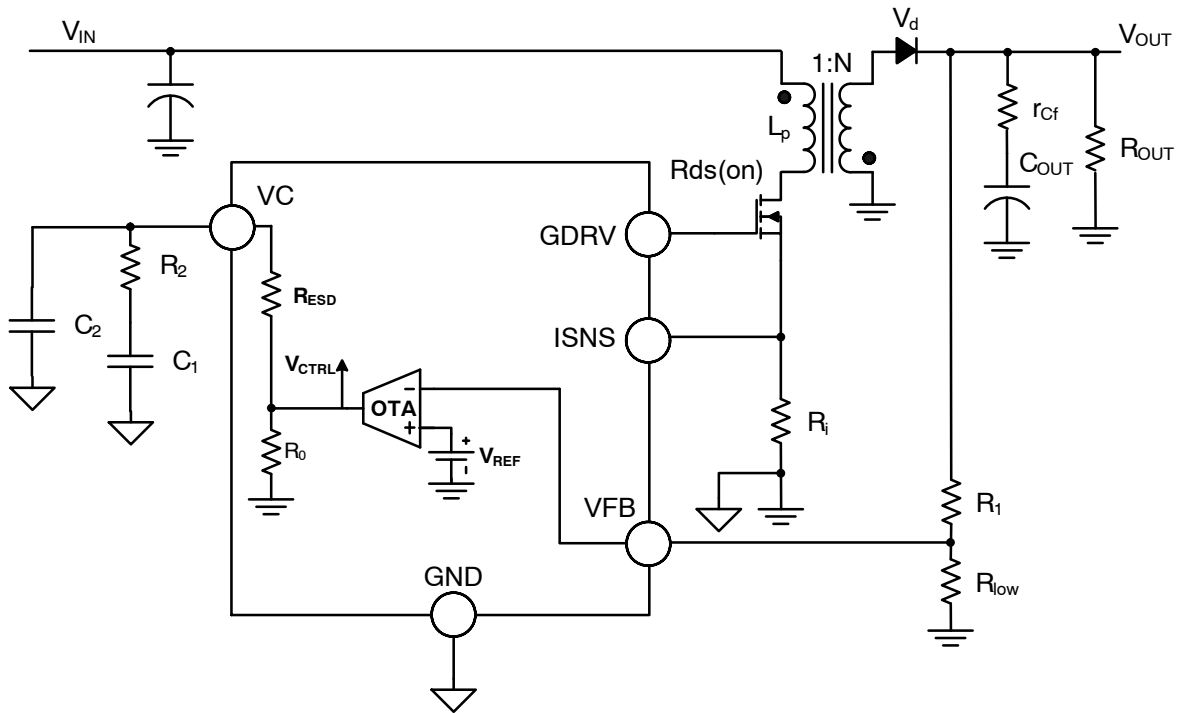

Figure 13. NCV887200 Flyback Converter OTA and Compensation

The following equations may be used to select compensation components R_2 , C_1 , C_2 for Figures 12 & 13 power supply. Required input design parameters for analysis are:

V_d = Output diode V_f (V)

V_{IN} = Power supply input voltage (V)

$N = N_s/N_p$ (Flyback transformer turns ratio)

R_i = Current sense resistor (Ω)

$R_{DS(on)}$ = MOSFET $R_{DS(on)}$ (Ω)

$(R_{sw_eq} = R_{DS(on)} + R_i$ for the boost continuous conduction mode (CCM) expressions)

C_{OUT} = Bulk output capacitor value (F)

r_{CF} = Bulk output capacitor ESR (Ω)

R_{OUT} = Equivalent resistance of output load (Ω)

P_{out} = Output Power (W)

L = Boost inductor value or flyback transformer primary side inductance (H)

r_L = Boost inductor ESR (Ω)

$T_s = 1/f_s$, where f_s = clock frequency (Hz)

R_1 and R_{low} = Feedback resistor divider values used to set the output voltage (Ω)

V_{OUT} = Device specific output voltage (defined by R_1 and R_{low} values) (V)

R_0 = OTA output resistance = 3 M Ω

S_a = IC slope compensation (e.g. 34 mV/ μ s for NCV887200)

g_m = OTA transconductance = 1.2 mS

D = Controller duty ratio

D' = 1 - D

Necessary equations for describing the modulator gain (V_{ctrl} -to- V_{out} gain) $H_{ctrl_output}(f)$ are described next. Boost continuous conduction mode (CCM) and discontinuous conduction mode (DCM) transfer function expressions are summarized in Table 1. Flyback CCM and DCM transfer function expressions are summarized in Table 2.

Table 1. BOOST CCM AND DCM TRANSFER FUNCTION EXPRESSIONS

	CCM	DCM
Duty Ratio (D)	$\frac{2R_{OUT}V_dV_{IN} - \left[R_{sw_eq} + R_{OUT} \left(\frac{V_{IN}}{V_{OUT}} - 2 \right) \right] V_{OUT}^2}{-V_{OUT} \sqrt{R_{OUT} \left(R_{OUT}V_{IN}^2 + 2R_{sw_eq}V_{IN}V_{OUT} - 4V_dR_{sw_eq}V_{IN} \right) - 4R_{sw_eq}V_{OUT}^2 - 4r_LV_dV_{IN} - 4r_LV_{OUT}^2} + R_{sw_eq}^2V_{OUT}^2}$ $2R_{OUT}(V_{OUT}^2 + V_dV_{IN})$	$\sqrt{2\tau_L M(M-1)}$ <p>Where: $\tau_L = \frac{L}{R_{OUT}T_s}$</p>
V_{OUT}/V_{IN} DC Conversion Ratio (M)	$\frac{1}{1-D} \left[1 - \frac{(1-D)V_d}{V_{OUT}} \right] \left[\frac{1}{1 + \frac{1}{(1-D)^2 \left(\frac{r_L + DR_{sw_eq}}{R_{OUT}} \right)}} \right]$	$\frac{1}{2} \left(1 + \sqrt{1 + \frac{2D^2}{\tau_L}} \right)$
Inductor On-slope (S_n), V/s	$\frac{V_{IN} - I_{Lave}(r_L + R_{sw_eq})}{L} R_i$ <p>Where average inductor current: $I_{Lave} = \frac{P_{out}}{V_{IN}\eta}$</p>	$\frac{V_{IN}}{L} R_i$
Compensation Ramp (m_c)	$1 + \frac{S_a}{S_n}$	$1 + \frac{S_a}{S_n}$
C _{out} ESR Zero (ω_{z1})	$\frac{1}{r_{CF} C_{OUT}}$	$\frac{1}{r_{CF} C_{OUT}}$
Right-Half-Plane Zero (ω_{z2})	$\frac{(1-D)^2}{L} \left(R_{OUT} - \frac{r_{CF} R_{OUT}}{r_{CF} + R_{OUT}} \right) - \frac{r_L}{L}$	$\frac{R_{OUT}}{M^2 L}$
Low Frequency Modulator Pole (ω_{p1})	$\frac{\frac{2}{R_{OUT}} + \frac{T_s}{LM^3} m_c}{C_{OUT}}$	$\frac{1}{R_{CF} C_{OUT}} \cdot \frac{2M-1}{M-1}$
High Frequency Modulator Pole (ω_{p2})	-	$2F_{SW} \left(\frac{1 - \frac{1}{M}}{D} \right)^2$
Sampling Double Pole (ω_n)	$\frac{\pi}{T_s}$	-
Sampling Quality Coefficient (Q_p)	$\frac{1}{\pi(m_c(1-D) - 0.5)}$	-
F_m	$\frac{1}{2M + \frac{R_{OUT}T_s}{LM^2} \left(\frac{1}{2} + \frac{S_a}{S_n} \right)}$	$\frac{1}{S_n m_c T_s}$
H_d	$\frac{\eta R_{OUT}}{R_i}$	$\frac{2V_{OUT}}{D} \cdot \frac{M-1}{2M-1}$
Control-Output Transfer Function (H_{ctrl_output}(f))	$F_m H_d \frac{\left(1 + j \frac{2\pi f}{\omega_{z1}} \right) \left(1 - j \frac{2\pi f}{\omega_{z2}} \right)}{\left(1 + j \frac{2\pi f}{\omega_{p1}} \right) \left(1 + j \frac{2\pi f}{\omega_{nQp}} + \left(j \frac{2\pi f}{\omega_n} \right)^2 \right)}$	$F_m H_d \frac{\left(1 + j \frac{2\pi f}{\omega_{z1}} \right) \left(1 - j \frac{2\pi f}{\omega_{z2}} \right)}{\left(1 + j \frac{2\pi f}{\omega_{p1}} \right) \left(1 + j \frac{2\pi f}{\omega_{p2}} \right)}$

Table 2. FLYBACK CCM AND DCM TRANSFER FUNCTION EXPRESSIONS

	CCM	DCM
Duty ratio (D)	$\frac{V_{OUT}}{V_{OUT} + NV_{IN}}$	$\frac{V_{OUT}}{NV_{IN}} \sqrt{2\tau_L}$ Where: $\tau_L = \frac{N^2 L_p}{T_s R_{OUT}}$
V_{OUT}/V_{IN} DC Conversion Ratio (M)	$\frac{N \cdot D}{1 - D}$	$\frac{N \cdot D}{\sqrt{2 \cdot \tau_L}}$
Inductor On-slope (S_n), V/s	$\frac{V_{IN}}{L_p} R_i$	$\frac{V_{IN}}{L_p} R_i$
Compensation Ramp (m_c)	$1 + \frac{S_a}{S_n}$	$1 + \frac{S_a}{S_n}$
C _{out} ESR Zero (ω_{z1})	$\frac{1}{r_{CF} C_{OUT}}$	$\frac{1}{r_{CF} C_{OUT}}$
Right-Half-Plane Zero (ω_{z2})	$\frac{(1 - D)^2 R_{OUT}}{D L_p N^2}$	$\frac{R_{OUT}}{N^2 L_p} \cdot \frac{1}{M(M + 1)}$
Modulator Pole (ω_{p1})	$\frac{\frac{D'^3}{\tau_L} \left(1 + 2 \frac{S_a}{S_n}\right) + 1 + D}{R_{OUT} C_{OUT}}$	$\frac{2}{R_{OUT} C_{OUT}}$
ω_{p2}	-	$2F_{SW} \left(\frac{\frac{1}{D}}{1 + \frac{1}{M}}\right)^2$
F_m	$\frac{1}{\frac{D'^2}{\tau_L} \left(1 + 2 \frac{S_a}{S_n}\right) + 2M + 1}$	$\frac{1}{S_n m_c T_s}$
H_d	$\frac{R_{OUT}}{R_i N}$	$V_{IN} \sqrt{\frac{1}{2\tau_L}}$
Control-output Transfer Function (H_{ctrl_output}(f))	$F_m H_d \frac{\left(1 + j \frac{2\pi f}{\omega_{z1}}\right) \left(1 - j \frac{2\pi f}{\omega_{z2}}\right)}{\left(1 + j \frac{2\pi f}{\omega_{p1}}\right)}$	$F_m H_d \frac{\left(1 + j \frac{2\pi f}{\omega_{z1}}\right) \left(1 - j \frac{2\pi f}{\omega_{z2}}\right)}{\left(1 + j \frac{2\pi f}{\omega_{p1}}\right) \left(1 + j \frac{2\pi f}{\omega_{p2}}\right)}$

Once the desired cross-over frequency (*f_c*) gain adjustment and necessary phase boost are determined from the *H_{ctrl_output}(f)* gain and phase plots, the Table 3 equations may be used. It should be noted that minor compensation

component value adjustments may become necessary when $R_2 \leq \sim 10 \cdot R_{esd}$ as a result of approximations for determining components *R₂*, *C₁*, *C₂*.

Table 3. OTA COMPENSATION TRANSFER FUNCTION AND COMPENSATION VALUES

Desired OTA Gain at Cross-over Frequency f_c (G)	$\frac{\text{desired } G_{f_c, \text{min, db}}}{10 \cdot \frac{20}{20}}$
Desired Phase Boost at Cross-over Frequency f_c (boost)	$\left(\theta_{\text{margin}} - \arg\left(H_{\text{ctrl_output}}(f_c)\right) \frac{180^\circ}{\pi} - 90^\circ \right) \frac{\pi}{180^\circ}$
Select OTA Compensation Zero to Coincide with Modulator Pole at f_{p1} (f_z)	$\frac{\omega_{p1e}}{2\pi}$
Resulting OTA High Frequency Pole Placement (f_p)	$\frac{f_z f_c + f_c^2 \tan(\text{boost})}{f_c - f_z \tan(\text{boost})}$
Compensation Resistor R_2	$\frac{f_p G}{f_p - f_z} \cdot \frac{V_{\text{OUT}}}{1.2 g_m} \cdot \frac{\sqrt{1 + \left(\frac{f_c}{f_p}\right)^2}}{\sqrt{1 + \left(\frac{f_z}{f_p}\right)^2}}$
Compensation Capacitor C_1	$\frac{1}{2\pi f_z R_2}$
Compensation Capacitor C_2	$\frac{1}{2\pi f_p G} \cdot \frac{R_{\text{low}} g_m}{R_{\text{low}} + R_1}$
OTA DC Gain (G_{0_OTA})	$\frac{R_{\text{low}}}{R_{\text{low}} + R_1} \cdot g_m \cdot R_0$
Low Frequency Zero (ω_{z1e})	$\frac{1}{2} \frac{(R_2 + R_{\text{esd}})}{R_2 R_{\text{esd}} C_2} \left[1 - \sqrt{1 - 4 \frac{R_2 R_{\text{esd}} C_2}{(R_2 + R_{\text{esd}})^2 C_1}} \right]$
High Frequency Zero (ω_{z2e})	$\frac{1}{2} \frac{(R_2 + R_{\text{esd}})}{R_2 R_{\text{esd}} C_2} \left[1 + \sqrt{1 - 4 \frac{R_2 R_{\text{esd}} C_2}{(R_2 + R_{\text{esd}})^2 C_1}} \right]$
Low Frequency Pole (ω_{p1e})	$\frac{1}{2} \frac{(R_0 + R_2 + R_{\text{esd}})}{R_2 (R_0 + R_{\text{esd}}) C_2} \left[1 - \sqrt{1 - 4 \frac{R_2 (R_0 + R_{\text{esd}}) C_2}{(R_0 + R_2 + R_{\text{esd}})^2 C_1}} \right]$
High Frequency Pole (ω_{p2e})	$\frac{1}{2} \frac{(R_0 + R_2 + R_{\text{esd}})}{R_2 (R_0 + R_{\text{esd}}) C_2} \left[1 + \sqrt{1 - 4 \frac{R_2 (R_0 + R_{\text{esd}}) C_2}{(R_0 + R_2 + R_{\text{esd}})^2 C_1}} \right]$
OTA Transfer Function ($G_{OTA}(f)$)	$-G_{0_OTA} \frac{\left(1 + j \frac{2\pi f}{\omega_{z1e}}\right) \left(1 + j \frac{2\pi f}{\omega_{z2e}}\right)}{\left(1 + j \frac{2\pi f}{\omega_{p1e}}\right) \left(1 + j \frac{2\pi f}{\omega_{p2e}}\right)}$

The open-loop-response in closed-loop form to verify the gain/phase margins may be obtained from the following expression.

$$T(f) = G_{OTA}(f) H_{\text{ctrl_output}}(f)$$

Low Voltage Operation

If the input voltage drops below the UVLO or MOSFET threshold voltage, another voltage may be used to power the

device. Simply connect the voltage you would like to boost to the inductor and connect the stable voltage to the VIN pin of the device. In boost configuration, the output of the converter can be used to power the device. In some cases it may be desirable to connect 2 sources to VIN pin, which can be accomplished simply by connecting each of the sources through a diode to the VIN pin.

onsemi, **Onsemi**, and other names, marks, and brands are registered and/or common law trademarks of Semiconductor Components Industries, LLC dba "**onsemi**" or its affiliates and/or subsidiaries in the United States and/or other countries. **onsemi** owns the rights to a number of patents, trademarks, copyrights, trade secrets, and other intellectual property. A listing of **onsemi**'s product/patent coverage may be accessed at www.onsemi.com/site/pdf/Patent-Marking.pdf. **onsemi** reserves the right to make changes at any time to any products or information herein, without notice. The information herein is provided "as-is" and **onsemi** makes no warranty, representation or guarantee regarding the accuracy of the information, product features, availability, functionality, or suitability of its products for any particular purpose, nor does **onsemi** assume any liability arising out of the application or use of any product or circuit, and specifically disclaims any and all liability, including without limitation special, consequential or incidental damages. Buyer is responsible for its products and applications using **onsemi** products, including compliance with all laws, regulations and safety requirements or standards, regardless of any support or applications information provided by **onsemi**. "Typical" parameters which may be provided in **onsemi** data sheets and/or specifications can and do vary in different applications and actual performance may vary over time. All operating parameters, including "Typicals" must be validated for each customer application by customer's technical experts. **onsemi** does not convey any license under any of its intellectual property rights nor the rights of others. **onsemi** products are not designed, intended, or authorized for use as a critical component in life support systems or any FDA Class 3 medical devices or medical devices with a same or similar classification in a foreign jurisdiction or any devices intended for implantation in the human body. Should Buyer purchase or use **onsemi** products for any such unintended or unauthorized application, Buyer shall indemnify and hold **onsemi** and its officers, employees, subsidiaries, affiliates, and distributors harmless against all claims, costs, damages, and expenses, and reasonable attorney fees arising out of, directly or indirectly, any claim of personal injury or death associated with such unintended or unauthorized use, even if such claim alleges that **onsemi** was negligent regarding the design or manufacture of the part. **onsemi** is an Equal Opportunity/Affirmative Action Employer. This literature is subject to all applicable copyright laws and is not for resale in any manner.

ADDITIONAL INFORMATION

TECHNICAL PUBLICATIONS:

Technical Library: www.onsemi.com/design/resources/technical-documentation
onsemi Website: www.onsemi.com

ONLINE SUPPORT: www.onsemi.com/support

For additional information, please contact your local Sales Representative at www.onsemi.com/support/sales